

ALLEGATO A

**Specifiche tecniche per la trasmissione
telematica Modello 730/2016**

INDICE

1	AVVERTENZE GENERALI	3
2	BREVI CENNI SUL LINGUAGGIO XML.....	3
3	CONTENUTO DELLA FORNITURA	5
3.1	GENERALITÀ.....	5
3.2	COERENZA DEI DATI DELLA DICHIARAZIONE	6
3.3	IL TRATTAMENTO DEL CODICE FISCALE	6
3.4	SOGGETTO CHE PRESTA L'ASSISTENZA FISCALE	7
4	TRASMISSIONE TELEMATICA DEL MOD. 730-4 DA PARTE DEI CAF, DEL PROFESSIONISTA ABILITATO O DI UNA ASSOCIAZIONE PROFESSIONALE ALL'AGENZIA DELLE ENTRATE E DESTINATO AI SOSTITUTI D'IMPOSTA.....	8
4.1	TRASMISSIONE TELEMATICA DEL MOD. 730-4: CASI PARTICOLARI.....	8
4.2	DATI MOD. 730-4 RESI DISPONIBILI DALL'AGENZIA DELLE ENTRATE AI SOSTITUTI O INTERMEDIARI	8
5	SPECIFICHE TECNICHE IN FORMATO XML.....	9
5.1	GENERALITÀ SPECIFICHE TECNICHE IN FORMATO XML.....	9
5.1.1	<i>Messaggio</i>	9
5.1.2	<i>Intestazione</i>	9
5.1.3	<i>Contenuto</i>	9
5.1.4	<i>Fornitura</i>	10
5.1.5	<i>Intestazione</i>	10
5.1.6	<i>Documento 730</i>	11
5.2	SPECIFICHE TECNICHE IN FORMATO XML	11

CONTENUTO E CARATTERISTICHE TECNICHE DEI DATI DELLE DICHIARAZIONI DEI REDDITI MODELLO 730/2016 DA INVIARE ALL'AMMINISTRAZIONE FINANZIARIA IN VIA TELEMATICA

1 AVVERTENZE GENERALI

I Sostituti d'imposta, i Centri di Assistenza Fiscale, i professionisti abilitati, le società e gli enti di grandi dimensioni, nonché gli intermediari abilitati, trasmettono i dati delle dichiarazioni dei Mod.730, all'**Agenzia delle Entrate** in via telematica.

Il contenuto e le caratteristiche della fornitura dei dati da trasmettere all'Agenzia delle Entrate in via telematica sono riportati nelle specifiche tecniche di seguito esposte.

Si precisa che una dichiarazione da inviare, i cui dati non sono conformi alle indicazioni delle presenti specifiche tecniche, verrà scartata.

Le modalità per la trasmissione dei dati in via telematica sono stabilite con il decreto del 31 luglio 1998 (pubblicato nella G.U. del 12 agosto 1998, n. 187) e successive modificazioni.

2 Brevi cenni sul linguaggio XML

L'Agenzia delle Entrate ha scelto di adottare, per la definizione della fornitura relativa alle dichiarazioni 730 2016, il linguaggio XML (eXtensible Markup Language).

L'XML è un metalinguaggio, ossia una "grammatica", per la definizione di documenti da gestire con strumenti informatici.

Per "grammatica" si intende l'insieme standard di definizioni e di regole sintattiche mediante le quali la struttura logica di un documento viene tradotta in una corrispondente struttura fisica, composta di elementi sintattici chiamati **tag**, ossia sequenze di caratteri delimitate dai segni '<' e '>'.

Concretamente, un file XML è un file di testo costituito da diversi **elementi** individuati dai **tag**, ciascuno dei quali identifica un componente logico del documento.

Gli **elementi** sono organizzati secondo una **struttura gerarchica**: ciascun **elemento** può infatti contenere altri elementi (**sottoelementi**) oppure del testo. L'elemento principale della struttura "ad albero" così ottenuta è denominato **radice (root element)**.

Agli **elementi** possono essere associate altre informazioni che ne descrivono le proprietà, tali informazioni sono chiamate **attributi**.

La modellazione della fornitura delle dichiarazioni 730/2016 è stata realizzata introducendo la radice denominata Messaggio, all'interno della quale sono stati individuati i due sottoelementi Intestazione e Contenuto.

L'elemento Intestazione espone il codice fiscale del soggetto responsabile dell'invio telematico, l'elemento Contenuto definisce al suo interno una Fornitura astratta che, nel caso del modello 730 2016, assume le caratteristiche di quella ad esso relativa e descritta nel paragrafo 5. L'elemento Contenuto espone l'attributo `codiceFornitura` che per il suddetto modello deve essere impostato al valore 73016.

Nel paragrafo 5 vengono fornite ulteriori indicazioni relative agli elementi sopra citati.

La struttura della fornitura xml è descritta, mediante l'**XML Schema**, in uno specifico documento (**schema document**), identificato dall'estensione "**xsd**". Il file XSD (XML Schema Definition) delinea il contenuto della fornitura definendone gli elementi ed evidenziandone attributi e relazioni reciproche.

In particolare, lo **schema** relativo alla fornitura xml identifica tre diverse tipologie di componenti: elementi di significato generale, ossia indipendenti dal tipo di documento contenuto nella fornitura stessa, elementi che rappresentano i componenti logici di una generica dichiarazione ed elementi che costituiscono, più specificamente, la struttura di una dichiarazione Modello 730.

Ciascuna delle suddette tipologie di componenti individua un "dominio di nomi" (**namespace**), un ambito nel quale gli elementi sono univoci ed hanno significato omogeneo.

Concretamente, lo schema relativo alla fornitura 730 si compone di un insieme di documenti `xsd`, associati ai tre diversi namespace, nei quali sono definiti, oltre agli elementi della fornitura, anche i tipi di dati ad essi associati ed alcuni elenchi di codici predefiniti previsti per gli elementi della dichiarazione.

3 CONTENUTO DELLA FORNITURA

3.1 Generalità

La fornitura oggetto della trasmissione telematica deve essere conforme alle specifiche dell'eXtensible Markup Language (XML) 1.0 (raccomandazione WC3 10 febbraio 1998) e deve essere codificata secondo la codifica UTF-8.

Il contenuto della fornitura xml, relativa al Modello 730/2016, deve inoltre soddisfare la sintassi descritta nel file XSD denominato “**fornitura730_2016_v1.xsd**”, allegato al presente documento.

Il suddetto schema definisce la struttura della fornitura xml, delineando gli elementi permessi, i loro attributi, i tipi di dati ad essi associati e la relazione gerarchica tra gli elementi stessi.

La procedura distribuita dall'Agenzia delle Entrate esegue una prima fase di **validazione** della fornitura, ossia di verifica che il file sia conforme allo schema ad esso associato ed una successiva fase di **controllo**, nella quale esamina la correttezza dei dati indicati applicando regole specifiche per ciascun elemento.

L'esito negativo della validazione determina lo scarto dell'intera fornitura.

I diagnostici generati in fase di **controllo** possono avere una diversa gravità a seconda dell'elemento interessato e possono determinare lo scarto della singola dichiarazione o dell'intera fornitura.

3.2 Coerenza dei dati della dichiarazione

Nella “*Circolare per la liquidazione ed il controllo del modello 730/2016*” trovano esposizione anche le regole che definiscono l'accoglimento o meno della dichiarazione 730/2016 da trasmettere in via telematica all'Agenzia delle Entrate. In particolare sono riportati, oltre a tutti i criteri per la puntuale determinazione delle imposte, anche i criteri di accoglimento della dichiarazione. Tali criteri, sono suddivisi in confermabili e bloccanti. La dichiarazione 730/2016 predisposta con le modalità previste nelle presenti specifiche tecniche XML, deve essere conforme ai criteri sopra citati. La non conformità della dichiarazione ai suddetti criteri, determina il non accoglimento della stessa in sede di trasmissione telematica.

3.3 Il trattamento del Codice Fiscale

I codici fiscali riportati nelle dichiarazioni mod. 730/2016 devono essere formalmente corretti. Si precisa che in sede di accoglimento delle dichiarazioni trasmesse in via telematica, costituirà oggetto di scarto della dichiarazione stessa l'indicazione di un **codice fiscale del contribuente** che, anche se formalmente corretto, non risulti registrato presso l'Anagrafe Tributaria.

Nel caso di omocodia del codice fiscale del contribuente risolta dall'Agenzia delle Entrate con l'attribuzione di un nuovo codice fiscale, l'indicazione in dichiarazione del precedente codice fiscale (omocodice) comporta, in sede di accoglimento delle dichiarazioni trasmesse in via telematica, lo scarto della dichiarazione.

Il codice fiscale del rappresentante deve essere registrato in Anagrafe Tributaria; la non registrazione comporta lo scarto della dichiarazione in fase di accettazione **senza possibilità di conferma della stessa.**

Il codice fiscale del sostituto d'imposta che effettuerà le operazioni di conguaglio deve essere registrato in Anagrafe Tributaria; la non registrazione comporta lo scarto della dichiarazione in fase di accettazione senza possibilità di conferma della stessa.

Anche ciascun codice fiscale indicato nel prospetto dei familiari a carico deve essere registrato in Anagrafe Tributaria; la non registrazione comporta lo scarto della dichiarazione in fase di accettazione senza possibilità di conferma della stessa.

3.4 Soggetto che presta l'assistenza fiscale

L'indicazione del soggetto che ha prestato l'assistenza fiscale con i relativi dati identificativi e l'indicazione della data di consegna del mod. 730/2016 sono obbligatori. Si rimanda alle istruzioni fornite nella circolare di liquidazione al paragrafo "Dati assistenza fiscale da riportare nel flusso telematico".

4 TRASMISSIONE TELEMATICA DEL MOD. 730-4 DA PARTE DEI CAF, DEL PROFESSIONISTA ABILITATO O DI UNA ASSOCIAZIONE PROFESSIONALE ALL'AGENZIA DELLE ENTRATE E DESTINATO AI SOSTITUTI D'IMPOSTA

Le modifiche normative apportate al D.M. n. 164 del 1999, prevedono che i soggetti che prestano l'assistenza fiscale trasmettano i risultati finali delle dichiarazioni relative al mod. 730 (mod. 730-4) non più direttamente ai sostituti d'imposta ma all'Agenzia delle Entrate la quale provvederà successivamente ad inviarli telematicamente al sostituto d'imposta.

Pertanto, in sede di trasmissione telematica delle dichiarazioni relative al modello 730/2016, qualora l'assistenza fiscale sia prestata da un CAF, da un professionista abilitato o da una associazione i dati relativi al suddetto mod. 730-4 dovranno essere allegati ai dati della dichiarazione mod. 730/2016 da trasmettere in via telematica.

In sede di accoglimento delle dichiarazioni trasmesse in via telematica, costituisce oggetto di controllo sia la presenza dei dati relativi al mod. 730-4 che la coerenza dei dati contenuti nel mod. 730-4 con quelli presenti nel modello 730/2016. Eventuali anomalie riscontrate determinano lo scarto della dichiarazione.

Ai sostituti d'imposta i dati relativi al mod. 730-4 saranno resi disponibili presso la sede telematica comunicata con l'apposito modello di comunicazione trasmesso all'Agenzia delle Entrate; si rimanda alle precisazioni contenute nel successivo paragrafo "Dati mod. 730-4 resi disponibili dall'Agenzia delle Entrate ai Sostituti o Intermediari".

4.1 Trasmissione telematica del mod. 730-4: Casi particolari

Nel caso in cui dalla liquidazione della dichiarazione (mod. 730 ordinario ovvero mod. 730 integrativo), risulti che non ci sia alcun importo da trattenere o da rimborsare a cura del sostituto d'imposta, i dati relativi al mod. 730-4 non devono essere riportati nel tracciato telematico della dichiarazione 730 2016 e deve essere impostato ad "1" l'apposito campo (**FlagAssenzaDati730-4**) previsto nelle presenti specifiche tecniche del modello 730/2016. La non corretta impostazione della suddetta casella determina lo scarto della dichiarazione 730/2016.

4.2 Dati mod. 730-4 resi disponibili dall'Agenzia delle Entrate ai Sostituti o Intermediari

I dati relativi al mod. 730-4 saranno resi disponibili da parte dell'Agenzia delle Entrate ai sostituti d'imposta ovvero agli intermediari da questi incaricati in conformità alle istruzioni contenute nelle presenti specifiche tecniche relative al mod. 730/2016 nella sezione riferita alla "**Fornitura 730-4**". La sintassi della fornitura relativa ai mod. 730-4 è descritta nel file XSD denominato "**fornitura734_2016_v1.xsd**" la cui documentazione è allegata al presente documento.

5 Specifiche tecniche in formato XML

5.1 Generalità Specifiche tecniche in formato XML

5.1.1 Messaggio

Lo schema prevede la definizione di un elemento principale (radice della struttura) denominato **Messaggio**. Esso è un elemento xml di tipo complesso contenente la sequenza ordinata di due sotto-elementi obbligatori **Intestazione** e **Contenuto** dei quali può essere presente una sola occorrenza.

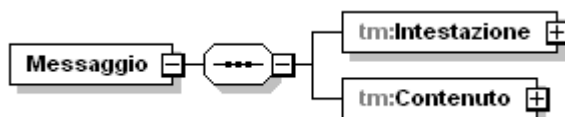

5.1.2 Intestazione

L'elemento xml denominato **Intestazione** è un elemento obbligatorio di tipo complesso **Intestazione_Type** illustrato nella figura seguente.

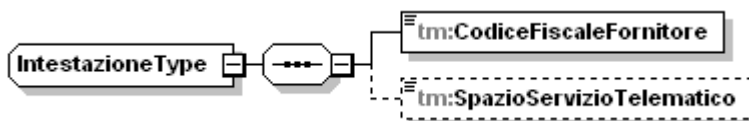

L'elemento **Intestazione** deve contenere i seguenti sottoelementi semplici rispettando la sequenza indicata:

CodiceFiscaleFornitore

E' un elemento obbligatorio di tipo semplice che deve esporre il codice fiscale del soggetto responsabile della trasmissione telematica. Il dato è di tipo alfanumerico e può essere composto, in alternativa, o da 11 caratteri numerici (nel caso in cui il codice fiscale si riferisca ad una persona giuridica) oppure da 16 caratteri alfanumerici maiuscoli (nel caso in cui il codice fiscale sia relativo ad una persona fisica).

SpazioServizioTelematico

E' un elemento opzionale che deve esporre alcune informazioni riservate al servizio telematico. Tale elemento, pertanto, viene creato esclusivamente da funzionalità predisposte dal servizio telematico. Il dato in esso contenuto è di tipo alfanumerico.

5.1.3 Contenuto

L'elemento xml denominato **Contenuto** deve contenere, al suo interno, i dati identificativi della fornitura ai fini della trasmissione telematica. Pertanto è un elemento di tipo complesso **Contenuto_Type** illustrato nella figura successiva.

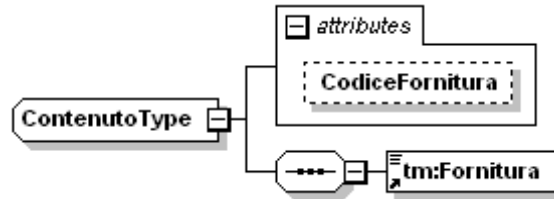

In particolare tale elemento prevede un attributo denominato **CodiceFornitura** ed un sottoelemento **Fornitura**.

L'attributo **CodiceFornitura** identifica il codice della fornitura e serve per individuare in maniera univoca la tipologia di documento contenuto nel file. Tale elemento di tipo semplice è obbligatorio e deve essere composto da 5 caratteri alfanumerici maiuscoli. Per il modello 730/2016 deve assumere il seguente valore “**73016**”.

L'elemento xml denominato **Fornitura**, invece, è un elemento obbligatorio di tipo astratto che deve essere, di volta in volta, implementato dai diversi tipi di fornitura XML.

Comunicazione dati rettificati caf o professionisti (Codice Fornitura “73C16”)

L'art. 6 (visto di conformità) del decreto legislativo 21 novembre 2014, n. 175, ha apportato delle modifiche all'art. 39 del decreto legislativo 9 luglio 1997, n. 241. In particolare, se il Caf o il professionista appone un visto di conformità infedele, è tenuto al pagamento di una somma pari all'importo dell'imposta, della sanzione e degli interessi che sarebbero stati richiesti al contribuente a seguito dei controlli formali da parte dell'Agenzia delle entrate, sempre che il visto infedele non sia stato indotto dalla condotta dolosa del contribuente. Se entro il 10 novembre dell'anno in cui la violazione è stata commessa il Caf o il professionista trasmette una dichiarazione rettificativa del contribuente oppure, se il contribuente non intende presentare la nuova dichiarazione, trasmette una comunicazione dei dati relativi alla rettifica, la somma dovuta dal Caf o dal professionista è pari all'importo della sola sanzione. **La trasmissione delle informazioni relative ai dati rettificati deve avvenire con modalità analoghe a quelle previste per la trasmissione telematica dei dati del modello 730 2016 in conformità alle indicazioni fornite nella Circolare di liquidazione del modello 730 2016 ed impostando l'attributo CodiceFornitura al valore “73C16”.**

5.1.4 Fornitura

L'elemento denominato **Fornitura** ed è un elemento xml complesso contenente la sequenza ordinata di due sottoelementi: **Intestazione** e **Documento730**, del quale possono essere presenti una o più occorrenze.

5.1.5 Intestazione

L'elemento Intestazione contiene i dati del soggetto responsabile dell'invio telematico (fornitore):

- TipoFornitore - è l'elemento che definisce la tipologia del soggetto che esegue la trasmissione, è di tipo DatoNP_Type.

- SpazioUtente - è un elemento opzionale il cui contenuto può essere liberamente definito dall'utente ed è di tipo DatoAN_Type

5.1.6 Documento 730

L'elemento Documento 730 è di tipo Documento_730_Type. Il tipo Documento_730_Type definisce l'attributo obbligatorio denominato **identificativo**. Tale attributo ha lo scopo di identificare univocamente il generico documento nell'ambito della fornitura ed è di tipo DatoNP_Type.

Controlli previsti per l'attributo:



Validazione: la lunghezza massima prevista è di 5 caratteri.

Controllo bloccante: il valore assunto dall'attributo deve essere univoco all'interno dell'intera fornitura.

5.2 Specifiche tecniche in formato XML

Di seguito viene descritto il contenuto informativo dei dati della fornitura da trasmettere in via telematica (**fornitura730_2016_v1.xsd e fornitura734_2016_v1.xsd**).

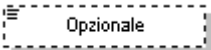
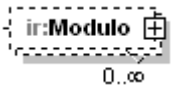
Per la rappresentazione grafica della struttura gerarchica sono utilizzati alcuni simboli grafici descritti nella seguente tabella:

	Elemento obbligatorio
	Elemento opzionale
	Elemento ripetuto 0 o più volte
	Sequenza ordinata di elementi (Sequence)
	Alternativa tra due o più elementi (Choice)

schema location: [fornitura730_2016_v1.xsd](#)
attribute form default: **unqualified**
element form default: **qualified**
targetNamespace: **urn:www.agenziaentrate.gov.it:specificheTecniche:sco:730**

Elements
[Fornitura](#)

schema location: [documento730_2016_v1.xsd](#)
attribute form default: **unqualified**
element form default: **qualified**
targetNamespace: **urn:www.agenziaentrate.gov.it:specificheTecniche:sco:730**

Elements
[Documento730](#)

Complex types

- [Acconti Altri Dati Type](#)
- [Acconti Irpef Anno Imposta Type](#)
- [Acconti Ritenute Type](#)
- [Acquisto Costruzione Abit Type](#)
- [Addizionali Type](#)
- [Altre Detrazioni Type](#)
- [Altre Ritenute Type](#)
- [Altre Spese Type](#)
- [Altri Dati Type](#)
- [Altri Oneri Type](#)
- [Altri Redditi Ass Lav Type](#)
- [Altri Redditi Diversi Detr Type](#)
- [Altri Redditi Diversi Type](#)
- [Altri Redditi Lavoro Autonomo Type](#)
- [Altri Redditi Type](#)
- [Altri Redditi Utili Type](#)
- [Annotazione Type](#)
- [Assegno Coniuge Type](#)
- [Bonus Irpef Type](#)
- [Casella Acconto Type](#)
- [Cedolare Secca Type](#)
- [Comunicazione Amministratore Type](#)
- [Conguaglio Type](#)
- [Contributi Previdenza Complementare Type](#)
- [Contributo Solidarieta Type](#)
- [Cred Erogazione Cultura Type](#)
- [Cred Imp Estero Type](#)
- [Crediti F24 Type](#)
- [Crediti Imposta Altri Sisma Abruzzo Type](#)
- [Crediti Imposta Fabbicati Type](#)

[Crediti Imposta Fondi Pensione Type](#)
[Crediti Imposta Redditi Esteri Type](#)
[Crediti Imposta Type](#)
[Credito Erogazioni Cultura Type](#)
[Credito Immobile Sisma Abruzzo Type](#)
[Credito Incremento Occupazione Type](#)
[Credito Negoziazione Type](#)
[Credito Stato Type](#)
[Credito Type](#)
[Dati 730 Integrativo Type](#)
[Dati Altre Detrazioni Modulo Type](#)
[Dati Altre Detrazioni Type](#)
[Dati Associazioni Professionale Type](#)
[Dati CAF Type](#)
[Dati Catastali Recupero Patrimonio Edilizio Type](#)
[Dati Catastali Type](#)
[Dati Condominio Type](#)
[Dati Coniuge Type](#)
[Dati Contabili Type](#)
[Dati Contratto Type](#)
[Dati Familiare Type](#)
[Dati Fornitore Type](#)
[Dati Nascita PF Type](#)
[Dati Primo Figlio Type](#)
[Dati Professionista Type](#)
[Dati Registrazione Accatastamento Recupero Patrimonio Edilizio Type](#)
[Dati Rettificati Type](#)
[Debito Type](#)
[Deduzioni Modulo Type](#)
[Deduzioni Type](#)
[Detrazione Crediti Type](#)
[Detrazioni Canoni Locazione Type](#)
[Detrazioni Modulo Type](#)
[Detrazioni Type](#)
[Dichiarazione Con Type](#)
[Dichiarazione Dich Type](#)
[Documento 730-4](#)
[Documento 730 Type](#)
[Domanda Accatastamento Type](#)
[Domicilio Fiscale Type](#)
[Domicilio Sogg Ass Fiscale Type](#)
[Eccedenze Type](#)
[Elemento Integrativo Type](#)
[Esenzione Add Comunale Type](#)
[Esenzione Bonus Type](#)

[Esito Liquidazione Type](#)
[Fabbricato Agev Type](#)
[Fabbricato Ord Type](#)
[Familiari Type](#)
[Firma Dichiarazione Type](#)
[Fondo Pensione Dipendenti Pubblici Type](#)
[Frontespizio 730 Type](#)
[Frontespizio Con Type](#)
[Frontespizio Dich Type](#)
[Fuori Assistenza Type](#)
[Giorni Percentuale Type](#)
[Importi Rimborsare 730-4 Integrativo Type](#)
[Importi Rimborsare 730-4 Type](#)
[Importi Trattenere 730-4 Type](#)
[Importo 730-4](#)
[Imposta Lorda Type](#)
[Imposta Netta Type](#)
[Imposte Rimborsate Type](#)
[Incremento Produttivita Type](#)
[Inquilini Abitazione Principale Type](#)
[Intervento Recupero Patrimonio Edilizio Type](#)
[Intervento Risparmio Energetico Type](#)
[Lavoro Dipendente Type](#)
[Misura Acconti Type](#)
[Mod730 Integrativo Type](#)
[Modulo Altri Redditi Type](#)
[Modulo Annotazioni Type](#)
[Modulo Comunicazione Type](#)
[Modulo Crediti Imposta Type](#)
[Modulo Credito Negoziazione Type](#)
[Modulo Fabbricato Type](#)
[Modulo Familiari Type](#)
[Modulo Lavoro Dip Type](#)
[Modulo Oneri Type](#)
[Modulo PL Type](#)
[Modulo Terreno Type](#)
[N Rate Type](#)
[Oneri Non Abbattuti Type](#)
[Oneri Type](#)
[Opzione Produttivita Type](#)
[Periodo Di Lavoro Type](#)
[Pignoramento Type](#)
[Primo Modulo Acconti Ritenute Type](#)
[Primo Modulo Crediti Imposta Type](#)
[Primo Modulo Familiari Type](#)

[Primo Modulo Lavoro Dip Type](#)
[Primo Modulo Oneri Type](#)
[Primo Modulo PL Type](#)
[Prospetto Annotazioni Type](#)
[Prospetto Liquidazione Type](#)
[Prospetto Type](#)
[Quadro I Type](#)
[Quadro K Type](#)
[Rappresentante Type](#)
[Redditi Capitale Type](#)
[Redditi Eredi Legatari Type](#)
[Redditi Fabbricati Type](#)
[Redditi Lavoro Dip Type](#)
[Redditi Ritenute Spese Type](#)
[Redditi Ritenute Type](#)
[Redditi Tassazione Separata Type](#)
[Redditi Terreni Type](#)
[Reddito Erede Type](#)
[Residenza Anagrafica 730 Type](#)
[Residenza Rappresentante Type](#)
[Residenza Type](#)
[Residuo Credito Compens Annolmposta Type](#)
[Residuo Credito Compens Type](#)
[Residuo Fabbricati Type](#)
[Restituzione Somme Type](#)
[Rettifica Type](#)
[Riepilogo Redditi Type](#)
[Ritenute Acconti Sospesi Type](#)
[Ritenute Lavoro Dip Type](#)
[Sezione Altri Redd Type](#)
[Sezione Dati Catastali Recupero Patrimonio Edilizio Type](#)
[Soggetto Assistenza Fiscale Doc Type](#)
[Soggetto Fiscale 730 Type](#)
[Soglie Esenzione Type](#)
[Sostituto Type](#)
[Spese Arredo Type](#)
[Spese Rateizzate Anni Precedenti Type](#)
[Spese Rateizzate Type](#)
[Tassazione Separata Type](#)
[Terreno Type](#)
[Versamenti F24 Type](#)

schema location: [intestazione730_2016_v1.xsd](#)
attribute form default: **unqualified**

element form default: **qualified**
targetNamespace: **urn:www.agenziaentrate.gov.it:specificheTecniche:sco:730**

Elements Complex types
[Intestazione](#) [Intestazione 730 Type](#)

schema location: [types730_2016_v1.xsd](#)
attribute form default: **unqualified**
element form default: **qualified**
targetNamespace: **urn:www.agenziaentrate.gov.it:specificheTecniche:sco:730**

Simple types

[Anno Anticipazione Fondo Pensione Type](#)
[Anno Patrimonio Edilizio Situazioni Particolari Type](#)
[Anno Recupero Patrimonio Edilizio Type](#)
[Anno Risparmio Energetico Type](#)
[Casella Codice Type](#)
[Casi Particolari Fabbricato Type](#)
[Casi Particolari Risp Ener Type](#)
[Casi Particolari Terreni Type](#)
[Codice Altre Detrazioni Type](#)
[Codice Altre Spese Type](#)
[Codice Altri Oneri Type](#)
[Codice Canone Type](#)
[Codice Evento Eccezionale Type](#)
[Codice Spese Rateizzate Anni Precedenti Type](#)
[Codice Spese Rateizzate Type](#)
[Fabbricato Agev Numero Rigo Type](#)
[Indeterminato Determinato Type](#)
[Integrativo Type](#)
[Mesi Type](#)
[Numero Rata Risparmio Energetico Type](#)
[Numero Rate5o10 Type](#)
[Numero RateDa1A3 Type](#)
[Numero RateDa1A7 Type](#)
[Periodo Spese Ristrutturazione Type](#)
[Rate10 Type](#)
[Rate5 Type](#)
[Rate Risparmio Energetico Type](#)
[Reintegro Totale Parziale Type](#)
[Rettificativo Type](#)
[Rideterminazione Rate Type](#)
[Ripart Risparmio Energetico Type](#)
[Serie Registrazione Contratto Type](#)
[Stato Civile Type](#)
[Terreni Urbano Type](#)
[Tipo Inquilino Type](#)
[Tipo Intervento Type](#)
[Tipo Reddito Da1a12 Type](#)
[Tipo Reddito Da1a3 Type](#)
[Tipo Reddito Da1a4 Type](#)
[Tipo Reddito Da1a6 Type](#)
[Tipo Reddito Da1a8 Type](#)
[Tipo Reddito Da1a9 Type](#)
[Tipologia Soggetto Ass Fisc Type](#)
[Titolo Terreno Type](#)
[Utilizzo Fabbricato Type](#)

schema location: [datiSce_2016_v1.xsd](#)
 attribute form default: **unqualified**
 element form default: **qualified**
 targetNamespace: **urn:www.agenziaentrate.gov.it:specificheTecniche:sco:sce**

Complex types
[Scelta2PerMille_Type](#)
[Scelta2PerMilleAssCult_Type](#)
[Scelta5PerMille_Type](#)
[Scelta8PerMille_Type](#)
[Scelte_Type](#)

element **Fornitura**

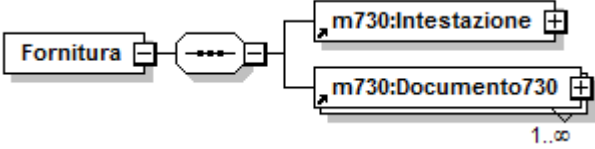
diagram	
namespace	urn:www.agenziaentrate.gov.it:specificheTecniche:sco:730
children	m730:Intestazione m730:Documento730

element **Documento730**

diagram					
namespace	urn:www.agenziaentrate.gov.it:specificheTecniche:sco:730				
type	m730:Documento_730_Type				
children	m730:DichiarazioneDich m730:DichiarazioneCon m730:AltriDati m730:Sostituto m730:Mod730DipendentiSenzaSostituto m730:SoggettoAssFiscaleDoc m730:Documento_730-4 m730:EsitiContabili m730:DatiRettificati				
attributes	Name	Type	Use	Default	Fixed
	identificativo	Identificativo_Type	required		

complexType **Acconti_Altri_Dati_Type**

diagram					
namespace	urn:www.agenziaentrate.gov.it:specificheTecniche:sco:730				
children	m730:IncapientiDetrazioneFigli m730:IncapientiDetrazioneLocazione m730:RestituzioneBonusFiscale				

	m730:RestituzioneBonusStraordinario m730:Pignoramento
--	---

element **Acconti_Altri_Dati_Type/IncapientiDetrazioneFigli**

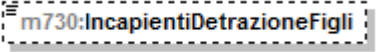
diagram	
namespace	urn:www.agenziaentrate.gov.it:specificheTecniche:sco:730
type	DatoNP_Type
facets	Kind Value pattern [1-9]{1}[0-9]*

element **Acconti_Altri_Dati_Type/IncapientiDetrazioneLocazione**

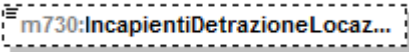
diagram	
namespace	urn:www.agenziaentrate.gov.it:specificheTecniche:sco:730
type	DatoNP_Type
facets	Kind Value pattern [1-9]{1}[0-9]*

element **Acconti_Altri_Dati_Type/RestituzioneBonusFiscale**

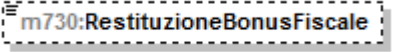
diagram	
namespace	urn:www.agenziaentrate.gov.it:specificheTecniche:sco:730
type	DatoNP_Type
facets	Kind Value pattern [1-9]{1}[0-9]*

element **Acconti_Altri_Dati_Type/RestituzioneBonusStraordinario**

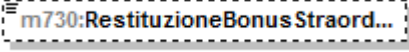
diagram	
namespace	urn:www.agenziaentrate.gov.it:specificheTecniche:sco:730
type	DatoNP_Type
facets	Kind Value pattern [1-9]{1}[0-9]*

element **Acconti_Altri_Dati_Type/Pignoramento**

diagram	
namespace	urn:www.agenziaentrate.gov.it:specificheTecniche:sco:730
type	m730:Pignoramento_Type
children	m730:TipoRedditoPignoramento m730:RitenutePignoramento

complexType **Acconti_Irpef_Anno_Imposta_Type**

diagram	
namespace	urn:www.agenziaentrate.gov.it:specificheTecniche:sco:730
children	m730:PrimaRataAccontolrpef m730:SecondaRataAccontolrpef m730:AccontoAddComunale m730:AccontoAddComunaleF24 m730:PrimaRataAccontoCedolare m730:SecondaRataAccontoCedo...

element **Acconti_Irpef_Anno_Imposta_Type/PrimaRataAccontolrpef**

diagram					
namespace	urn:www.agenziaentrate.gov.it:specificheTecniche:sco:730				
type	DatoNP_Type				
facets	<table border="1"> <tr> <td>Kind</td> <td>Value</td> </tr> <tr> <td>pattern</td> <td>[1-9]{1}[0-9]*</td> </tr> </table>	Kind	Value	pattern	[1-9]{1}[0-9]*
Kind	Value				
pattern	[1-9]{1}[0-9]*				

element **Acconti_Irpef_Anno_Imposta_Type/SecondaRataAccontolrpef**

diagram	
namespace	urn:www.agenziaentrate.gov.it:specificheTecniche:sco:730
type	DatoNP_Type

facets	Kind	Value
	pattern	[1-9]{1}[0-9]*

element **Acconti_Irpef_Anno_Imposta_Type/AccontoAddComunale**

diagram	 m730:AccontoAddComunale	
namespace	urn:www.agenziaentrate.gov.it:specificheTecniche:sco:730	
type	DatoNP_Type	
facets	Kind	Value
	pattern	[1-9]{1}[0-9]*

element **Acconti_Irpef_Anno_Imposta_Type/AccontoAddComunaleF24**

diagram	 m730:AccontoAddComunaleF24	
namespace	urn:www.agenziaentrate.gov.it:specificheTecniche:sco:730	
type	DatoNP_Type	
facets	Kind	Value
	pattern	[1-9]{1}[0-9]*

element **Acconti_Irpef_Anno_Imposta_Type/PrimaRataAccontoCedolare**

diagram	 m730:PrimaRataAccontoCedolare	
namespace	urn:www.agenziaentrate.gov.it:specificheTecniche:sco:730	
type	DatoNP_Type	
facets	Kind	Value
	pattern	[1-9]{1}[0-9]*

element **Acconti_Irpef_Anno_Imposta_Type/SecondaRataAccontoCedolare**

diagram	 m730:SecondaRataAccontoCedo...	
namespace	urn:www.agenziaentrate.gov.it:specificheTecniche:sco:730	
type	DatoNP_Type	
facets	Kind	Value
	pattern	[1-9]{1}[0-9]*

complexType **Acconti_Ritenute_Type**

diagram	
namespace	urn:www.agenziaentrate.gov.it:specificheTecniche:sco:730
children	m730:PrimoModulo m730:Modulo

element **Acconti_Ritenute_Type/PrimoModulo**

diagram	
namespace	urn:www.agenziaentrate.gov.it:specificheTecniche:sco:730
type	m730:Primo_Modulo_Acconti_Ritenute_Type
children	m730:Accontilrpef m730:AltreRitenute m730:Eccedenze m730:RitenuteAccontiSospesi m730:MisuraAcconti m730:EsenzioneAddComunale m730:Dati730Integrativo m730:AccontiAltriDati

element **Acconti_Ritenute_Type/Modulo**

diagram	
namespace	urn:www.agenziaentrate.gov.it:specificheTecniche:sco:730
children	m730:Pignoramento

element **Acconti_Ritenute_Type/Modulo/Pignoramento**

diagram	
namespace	urn:www.agenziaentrate.gov.it:specificheTecniche:sco:730
type	m730:Pignoramento_Type
children	m730:TipoRedditoPignoramento m730:RitenutePignoramento

complexType **Acquisto_Costruzione_Abit_Type**

diagram	
namespace	urn:www.agenziaentrate.gov.it:specificheTecniche:sco:730
children	m730:DataStipula m730:Spesa m730:InteressiMutuo

element **Acquisto_Costruzione_Abit_Type/DataStipula**

diagram					
namespace	urn:www.agenziaentrate.gov.it:specificheTecniche:sco:730				
type	DatoDT_Type				
facets	<table border="1"> <thead> <tr> <th>Kind</th> <th>Value</th> </tr> </thead> <tbody> <tr> <td>pattern</td> <td>((([0-9]{1,2}[0-9]{3,4}) (0[13578]1012)\d{4})) ((([0-9]{1,2}[0-9]{3,4}) (0[469]11)\d{4})) ((([0-9]{1,2}[0-9]{3,4}) (0[8]02)\d{4})) ((29)(02)([02468]048)) ((29)(02)([13579]2600)) ((29)(02)([0-9]0[048])) ((29)(02)([0-9]0[2468]048)) ((29)(02)([0-9]0[13579]26))</td> </tr> </tbody> </table>	Kind	Value	pattern	((([0-9]{1,2}[0-9]{3,4}) (0[13578]1012)\d{4})) ((([0-9]{1,2}[0-9]{3,4}) (0[469]11)\d{4})) ((([0-9]{1,2}[0-9]{3,4}) (0[8]02)\d{4})) ((29)(02)([02468]048)) ((29)(02)([13579]2600)) ((29)(02)([0-9]0[048])) ((29)(02)([0-9]0[2468]048)) ((29)(02)([0-9]0[13579]26))
Kind	Value				
pattern	((([0-9]{1,2}[0-9]{3,4}) (0[13578]1012)\d{4})) ((([0-9]{1,2}[0-9]{3,4}) (0[469]11)\d{4})) ((([0-9]{1,2}[0-9]{3,4}) (0[8]02)\d{4})) ((29)(02)([02468]048)) ((29)(02)([13579]2600)) ((29)(02)([0-9]0[048])) ((29)(02)([0-9]0[2468]048)) ((29)(02)([0-9]0[13579]26))				

element **Acquisto_Costruzione_Abit_Type/Spesa**

diagram					
namespace	urn:www.agenziaentrate.gov.it:specificheTecniche:sco:730				
type	DatoNP_Type				
facets	<table border="1"> <thead> <tr> <th>Kind</th> <th>Value</th> </tr> </thead> <tbody> <tr> <td>pattern</td> <td>[1-9]{1}[0-9]*</td> </tr> </tbody> </table>	Kind	Value	pattern	[1-9]{1}[0-9]*
Kind	Value				
pattern	[1-9]{1}[0-9]*				

element **Acquisto_Costruzione_Abit_Type/InteressiMutuo**

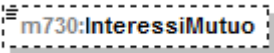
diagram	
namespace	urn:www.agenziaentrate.gov.it:specificheTecniche:sco:730
type	DatoNP_Type
facets	Kind Value pattern [1-9]{1}[0-9]*

complexType **Addizionali_Type**

diagram	
namespace	urn:www.agenziaentrate.gov.it:specificheTecniche:sco:730
children	m730:Imponibile m730:AddRegDovuta m730:AddRegCertif m730:EccedenzaAddReg m730:AddComDovuta m730:AddComCertif m730:EccedenzaAddCom m730:AccontoAddCom m730:AccontoAddComCertif

element **Addizionali_Type/Imponibile**

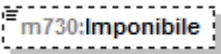
diagram	
namespace	urn:www.agenziaentrate.gov.it:specificheTecniche:sco:730
type	DatoNP_Type
facets	Kind Value pattern [1-9]{1}[0-9]*

element **Addizionali_Type/AddRegDovuta**

diagram	
---------	---

namespace	urn:www.agenziaentrate.gov.it:specificheTecniche:sco:730
type	DatoNP_Type
facets	Kind Value pattern [1-9]{1}[0-9]*

element **Addizionali_Type/AddRegCertif**

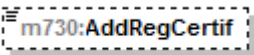
diagram	
namespace	urn:www.agenziaentrate.gov.it:specificheTecniche:sco:730
type	DatoNP_Type
facets	Kind Value pattern [1-9]{1}[0-9]*

element **Addizionali_Type/EccedenzaAddReg**

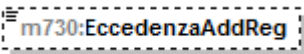
diagram	
namespace	urn:www.agenziaentrate.gov.it:specificheTecniche:sco:730
type	DatoNU_Type
facets	Kind Value pattern (\-[1-9] [1-9])[0-9]*

element **Addizionali_Type/AddComDovuta**

diagram	
namespace	urn:www.agenziaentrate.gov.it:specificheTecniche:sco:730
type	DatoNP_Type
facets	Kind Value pattern [1-9]{1}[0-9]*

element **Addizionali_Type/AddComCertif**

diagram	
namespace	urn:www.agenziaentrate.gov.it:specificheTecniche:sco:730
type	DatoNP_Type
facets	Kind Value pattern [1-9]{1}[0-9]*

element **Additionali_Type/EccedenzaAddCom**

diagram					
namespace	urn:www.agenziaentrate.gov.it:specificheTecniche:sco:730				
type	DatoNU_Type				
facets	<table border="1"> <tr> <td>Kind</td> <td>Value</td> </tr> <tr> <td>pattern</td> <td>(\-[1-9]) [1-9])[0-9]*</td> </tr> </table>	Kind	Value	pattern	(\-[1-9]) [1-9])[0-9]*
Kind	Value				
pattern	(\-[1-9]) [1-9])[0-9]*				

element **Additionali_Type/AccontoAddCom**

diagram					
namespace	urn:www.agenziaentrate.gov.it:specificheTecniche:sco:730				
type	DatoNP_Type				
facets	<table border="1"> <tr> <td>Kind</td> <td>Value</td> </tr> <tr> <td>pattern</td> <td>[1-9]{1}[0-9]*</td> </tr> </table>	Kind	Value	pattern	[1-9]{1}[0-9]*
Kind	Value				
pattern	[1-9]{1}[0-9]*				

element **Additionali_Type/AccontoAddComCertif**

diagram					
namespace	urn:www.agenziaentrate.gov.it:specificheTecniche:sco:730				
type	DatoNP_Type				
facets	<table border="1"> <tr> <td>Kind</td> <td>Value</td> </tr> <tr> <td>pattern</td> <td>[1-9]{1}[0-9]*</td> </tr> </table>	Kind	Value	pattern	[1-9]{1}[0-9]*
Kind	Value				
pattern	[1-9]{1}[0-9]*				

complexType **Altre_Detrazioni_Type**

diagram	
namespace	urn:www.agenziaentrate.gov.it:specificheTecniche:sco:730
children	m730:Codice m730:Importo

element **Altre_Detrazioni_Type/Codice**

diagram									
namespace	urn:www.agenziaentrate.gov.it:specificheTecniche:sco:730								
type	m730:Codice Altre_Detrazioni_Type								
facets	<table border="1"> <tr> <td>Kind</td> <td>Value</td> </tr> <tr> <td>pattern</td> <td>[1-9]{1}[0-9]*</td> </tr> <tr> <td>enumeration</td> <td>1</td> </tr> <tr> <td>enumeration</td> <td>2</td> </tr> </table>	Kind	Value	pattern	[1-9]{1}[0-9]*	enumeration	1	enumeration	2
Kind	Value								
pattern	[1-9]{1}[0-9]*								
enumeration	1								
enumeration	2								

element **Altre_Detrazioni_Type/Importo**

diagram	
namespace	urn:www.agenziaentrate.gov.it:specificheTecniche:sco:730
type	DatoNP_Type
facets	Kind Value pattern [1-9]{1}[0-9]*

complexType **Altre_Ritenute_Type**

diagram	
namespace	urn:www.agenziaentrate.gov.it:specificheTecniche:sco:730
children	m730:AltreRitenuteIrpef m730:AddizionaleRegionale m730:AddizionaleComunale m730:AddRegionaleIrpefAttivitaSport m730:AddComunaleIrpefAttivitaSport m730:IrpefLavoriSocialmenteUtili m730:AddRegionaleIrpefLavoriSoc Utili

element **Altre_Ritenute_Type/AltreRitenuteIrpef**

diagram	
namespace	urn:www.agenziaentrate.gov.it:specificheTecniche:sco:730
type	DatoNP_Type
facets	Kind Value pattern [1-9]{1}[0-9]*

element **Altre_Ritenute_Type/AddizionaleRegionale**

diagram	
namespace	urn:www.agenziaentrate.gov.it:specificheTecniche:sco:730

type	DatoNP_Type
facets	Kind Value pattern [1-9]{1}[0-9]*

element **Altre_Ritenute_Type/AddizionaleComunale**

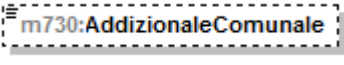
diagram	
namespace	urn:www.agenziaentrate.gov.it:specificheTecniche:sco:730
type	DatoNP_Type
facets	Kind Value pattern [1-9]{1}[0-9]*

element **Altre_Ritenute_Type/AddRegionaleIrpefAttivitaSport**

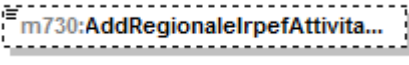
diagram	
namespace	urn:www.agenziaentrate.gov.it:specificheTecniche:sco:730
type	DatoNP_Type
facets	Kind Value pattern [1-9]{1}[0-9]*

element **Altre_Ritenute_Type/AddComunaleIrpefAttivitaSport**

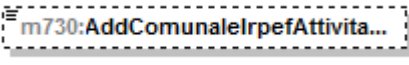
diagram	
namespace	urn:www.agenziaentrate.gov.it:specificheTecniche:sco:730
type	DatoNP_Type
facets	Kind Value pattern [1-9]{1}[0-9]*

element **Altre_Ritenute_Type/IrpefLavoriSocialmenteUtili**

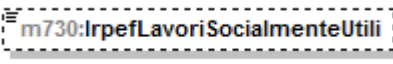
diagram	
namespace	urn:www.agenziaentrate.gov.it:specificheTecniche:sco:730
type	DatoNP_Type
facets	Kind Value pattern [1-9]{1}[0-9]*

element **Altre_Ritenute_Type/AddRegionaleIrpefLavoriSoc_Utili**

diagram	
---------	---

namespace	urn:www.agenziaentrate.gov.it:specificheTecniche:sco:730				
type	DatoNP_Type				
facets	<table border="1"> <thead> <tr> <th>Kind</th> <th>Value</th> </tr> </thead> <tbody> <tr> <td>pattern</td> <td>[1-9]{1}[0-9]*</td> </tr> </tbody> </table>	Kind	Value	pattern	[1-9]{1}[0-9]*
Kind	Value				
pattern	[1-9]{1}[0-9]*				

complexType **Altre_Spese_Type**

diagram	
namespace	urn:www.agenziaentrate.gov.it:specificheTecniche:sco:730
children	m730:Codice m730:Importo

element **Altre_Spese_Type/Codice**

diagram																																																																			
namespace	urn:www.agenziaentrate.gov.it:specificheTecniche:sco:730																																																																		
type	restriction of m730:Codice Altre_Spese_Type																																																																		
facets	<table border="1"> <thead> <tr> <th>Kind</th> <th>Value</th> </tr> </thead> <tbody> <tr> <td>pattern</td> <td>[1-9]{1}[0-9]*</td> </tr> <tr><td>enumeration</td><td>8</td></tr> <tr><td>enumeration</td><td>9</td></tr> <tr><td>enumeration</td><td>10</td></tr> <tr><td>enumeration</td><td>11</td></tr> <tr><td>enumeration</td><td>12</td></tr> <tr><td>enumeration</td><td>13</td></tr> <tr><td>enumeration</td><td>14</td></tr> <tr><td>enumeration</td><td>15</td></tr> <tr><td>enumeration</td><td>16</td></tr> <tr><td>enumeration</td><td>17</td></tr> <tr><td>enumeration</td><td>18</td></tr> <tr><td>enumeration</td><td>20</td></tr> <tr><td>enumeration</td><td>21</td></tr> <tr><td>enumeration</td><td>22</td></tr> <tr><td>enumeration</td><td>23</td></tr> <tr><td>enumeration</td><td>24</td></tr> <tr><td>enumeration</td><td>25</td></tr> <tr><td>enumeration</td><td>26</td></tr> <tr><td>enumeration</td><td>27</td></tr> <tr><td>enumeration</td><td>28</td></tr> <tr><td>enumeration</td><td>29</td></tr> <tr><td>enumeration</td><td>30</td></tr> <tr><td>enumeration</td><td>31</td></tr> <tr><td>enumeration</td><td>32</td></tr> <tr><td>enumeration</td><td>33</td></tr> <tr><td>enumeration</td><td>35</td></tr> <tr><td>enumeration</td><td>36</td></tr> <tr><td>enumeration</td><td>37</td></tr> <tr><td>enumeration</td><td>41</td></tr> <tr><td>enumeration</td><td>42</td></tr> <tr><td>enumeration</td><td>99</td></tr> </tbody> </table>	Kind	Value	pattern	[1-9]{1}[0-9]*	enumeration	8	enumeration	9	enumeration	10	enumeration	11	enumeration	12	enumeration	13	enumeration	14	enumeration	15	enumeration	16	enumeration	17	enumeration	18	enumeration	20	enumeration	21	enumeration	22	enumeration	23	enumeration	24	enumeration	25	enumeration	26	enumeration	27	enumeration	28	enumeration	29	enumeration	30	enumeration	31	enumeration	32	enumeration	33	enumeration	35	enumeration	36	enumeration	37	enumeration	41	enumeration	42	enumeration	99
Kind	Value																																																																		
pattern	[1-9]{1}[0-9]*																																																																		
enumeration	8																																																																		
enumeration	9																																																																		
enumeration	10																																																																		
enumeration	11																																																																		
enumeration	12																																																																		
enumeration	13																																																																		
enumeration	14																																																																		
enumeration	15																																																																		
enumeration	16																																																																		
enumeration	17																																																																		
enumeration	18																																																																		
enumeration	20																																																																		
enumeration	21																																																																		
enumeration	22																																																																		
enumeration	23																																																																		
enumeration	24																																																																		
enumeration	25																																																																		
enumeration	26																																																																		
enumeration	27																																																																		
enumeration	28																																																																		
enumeration	29																																																																		
enumeration	30																																																																		
enumeration	31																																																																		
enumeration	32																																																																		
enumeration	33																																																																		
enumeration	35																																																																		
enumeration	36																																																																		
enumeration	37																																																																		
enumeration	41																																																																		
enumeration	42																																																																		
enumeration	99																																																																		

element **Altre_Spese_Type/Importo**

diagram	
namespace	urn:www.agenziaentrate.gov.it:specificheTecniche:sco:730
type	DatoNP_Type
facets	Kind Value pattern [1-9]{1}[0-9]*

complexType **Altri_Dati_Type**

diagram	
namespace	urn:www.agenziaentrate.gov.it:specificheTecniche:sco:730
children	m730:ResiduoCreditoErogazioneCultura m730:ResiduoCreditoPrimaCasa m730:ResiduoCreditoOccupazione m730:ResiduoCreditoSisma m730:ResiduoCreditoFondiPensione m730:ResiduoCreditoMediazioni m730:TotSpeseSanitarieRateizzate m730:RedditoAgevolazioniFiscali m730:RedditoComplessivoAcconto m730:RigoDifferenzaAcconto m730:RedditiFondariNonImponibili m730:RedditoAbitazionePrincipale m730:ResiduoDeduzioneSommeRestituite m730:CreditoErogazioneCultura

element **Altri_Dati_Type/ResiduoCreditoErogazioneCultura**

diagram	 m730:ResiduoCreditoErogazion...
namespace	urn:www.agenziaentrate.gov.it:specificheTecniche:sco:730
type	DatoNP_Type
facets	Kind Value pattern [1-9]{1}[0-9]*

element **Altri_Dati_Type/ResiduoCreditoPrimaCasa**

diagram	 m730:ResiduoCreditoPrimaCasa
namespace	urn:www.agenziaentrate.gov.it:specificheTecniche:sco:730
type	DatoNP_Type
facets	Kind Value pattern [1-9]{1}[0-9]*

element **Altri_Dati_Type/ResiduoCreditoOccupazione**

diagram	 m730:ResiduoCreditoOccupazio...
namespace	urn:www.agenziaentrate.gov.it:specificheTecniche:sco:730
type	DatoNP_Type
facets	Kind Value pattern [1-9]{1}[0-9]*

element **Altri_Dati_Type/ResiduoCreditoSisma**

diagram	 m730:ResiduoCreditoSisma
namespace	urn:www.agenziaentrate.gov.it:specificheTecniche:sco:730
type	DatoNP_Type
facets	Kind Value pattern [1-9]{1}[0-9]*

element **Altri_Dati_Type/ResiduoCreditoFondiPensione**

diagram	 m730:ResiduoCreditoFondiPens...
namespace	urn:www.agenziaentrate.gov.it:specificheTecniche:sco:730
type	DatoNP_Type
facets	Kind Value pattern [1-9]{1}[0-9]*

element **Altri_Dati_Type/ResiduoCreditoMediazioni**

diagram	 m730:ResiduoCreditoMediazioni				
namespace	urn:www.agenziaentrate.gov.it:specificheTecniche:sco:730				
type	DatoNP_Type				
facets	<table border="1"> <tr> <td>Kind</td> <td>Value</td> </tr> <tr> <td>pattern</td> <td>[1-9]{1}[0-9]*</td> </tr> </table>	Kind	Value	pattern	[1-9]{1}[0-9]*
Kind	Value				
pattern	[1-9]{1}[0-9]*				

element **Altri_Dati_Type/TotSpeseSanitarieRateizzate**

diagram	 m730:TotSpese SanitarieRateizza...				
namespace	urn:www.agenziaentrate.gov.it:specificheTecniche:sco:730				
type	DatoNP_Type				
facets	<table border="1"> <tr> <td>Kind</td> <td>Value</td> </tr> <tr> <td>pattern</td> <td>[1-9]{1}[0-9]*</td> </tr> </table>	Kind	Value	pattern	[1-9]{1}[0-9]*
Kind	Value				
pattern	[1-9]{1}[0-9]*				

element **Altri_Dati_Type/RedditoAgevolazioniFiscali**

diagram	 m730:RedditoAgevolazioniFiscali				
namespace	urn:www.agenziaentrate.gov.it:specificheTecniche:sco:730				
type	DatoNP_Type				
facets	<table border="1"> <tr> <td>Kind</td> <td>Value</td> </tr> <tr> <td>pattern</td> <td>[1-9]{1}[0-9]*</td> </tr> </table>	Kind	Value	pattern	[1-9]{1}[0-9]*
Kind	Value				
pattern	[1-9]{1}[0-9]*				

element **Altri_Dati_Type/RedditoComplessivoAcconto**

diagram	 m730:RedditoComplessivoAcco...				
namespace	urn:www.agenziaentrate.gov.it:specificheTecniche:sco:730				
type	DatoNP_Type				
facets	<table border="1"> <tr> <td>Kind</td> <td>Value</td> </tr> <tr> <td>pattern</td> <td>[1-9]{1}[0-9]*</td> </tr> </table>	Kind	Value	pattern	[1-9]{1}[0-9]*
Kind	Value				
pattern	[1-9]{1}[0-9]*				

element **Altri_Dati_Type/RigoDifferenzaAcconto**

diagram	 m730:RigoDifferenzaAcconto				
namespace	urn:www.agenziaentrate.gov.it:specificheTecniche:sco:730				
type	DatoNU_Type				
facets	<table border="1"> <tr> <td>Kind</td> <td>Value</td> </tr> <tr> <td>pattern</td> <td>(\-[1-9] [1-9])[0-9]*</td> </tr> </table>	Kind	Value	pattern	(\-[1-9] [1-9])[0-9]*
Kind	Value				
pattern	(\-[1-9] [1-9])[0-9]*				

element **Altri_Dati_Type/RedditiFondiaciNonImponibili**

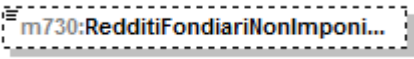
diagram	
namespace	urn:www.agenziaentrate.gov.it:specificheTecniche:sco:730
type	DatoNP_Type
facets	Kind Value pattern [1-9]{1}[0-9]*

element **Altri_Dati_Type/RedditoAbitazionePrincipalePertinenze**

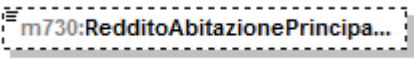
diagram	
namespace	urn:www.agenziaentrate.gov.it:specificheTecniche:sco:730
type	DatoNP_Type
facets	Kind Value pattern [1-9]{1}[0-9]*

element **Altri_Dati_Type/ResiduoDeduzioneSommeRestituite**

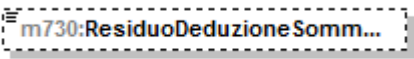
diagram	
namespace	urn:www.agenziaentrate.gov.it:specificheTecniche:sco:730
type	DatoNP_Type
facets	Kind Value pattern [1-9]{1}[0-9]*

element **Altri_Dati_Type/CreditoErogazioneCultura**

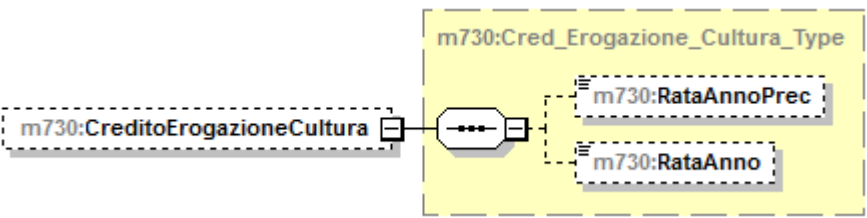
diagram	
namespace	urn:www.agenziaentrate.gov.it:specificheTecniche:sco:730
type	m730:Cred_Erogazione_Cultura_Type
children	m730:RataAnnoPrec m730:RataAnno

complexType Altri_Oneri_Type

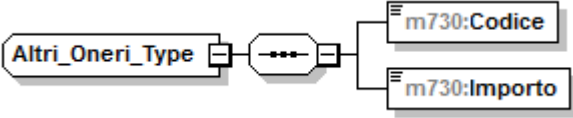
diagram	
namespace	urn:www.agenziaentrate.gov.it:specificheTecniche:sco:730
children	m730:Codice m730:Importo

element Altri_Oneri_Type/Codice

diagram															
namespace	urn:www.agenziaentrate.gov.it:specificheTecniche:sco:730														
type	m730:Codice_Altri_Oneri_Type														
facets	<table border="1"> <thead> <tr> <th>Kind</th> <th>Value</th> </tr> </thead> <tbody> <tr> <td>pattern</td> <td>[1-9]{1}[0-9]*</td> </tr> <tr> <td>enumeration</td> <td>6</td> </tr> <tr> <td>enumeration</td> <td>7</td> </tr> <tr> <td>enumeration</td> <td>8</td> </tr> <tr> <td>enumeration</td> <td>9</td> </tr> <tr> <td>enumeration</td> <td>11</td> </tr> </tbody> </table>	Kind	Value	pattern	[1-9]{1}[0-9]*	enumeration	6	enumeration	7	enumeration	8	enumeration	9	enumeration	11
Kind	Value														
pattern	[1-9]{1}[0-9]*														
enumeration	6														
enumeration	7														
enumeration	8														
enumeration	9														
enumeration	11														

element Altri_Oneri_Type/Importo

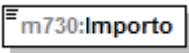
diagram					
namespace	urn:www.agenziaentrate.gov.it:specificheTecniche:sco:730				
type	DatoNP_Type				
facets	<table border="1"> <thead> <tr> <th>Kind</th> <th>Value</th> </tr> </thead> <tbody> <tr> <td>pattern</td> <td>[1-9]{1}[0-9]*</td> </tr> </tbody> </table>	Kind	Value	pattern	[1-9]{1}[0-9]*
Kind	Value				
pattern	[1-9]{1}[0-9]*				

complexType Altri_Redditi_Ass_Lav_Type

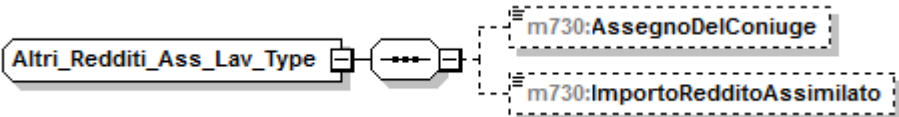
diagram	
namespace	urn:www.agenziaentrate.gov.it:specificheTecniche:sco:730
children	m730:AssegnoDelConiuge m730:ImportoRedditoAssimilato

element Altri_Redditi_Ass_Lav_Type/AssegnoDelConiuge

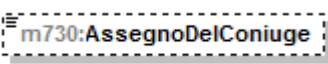
diagram	
namespace	urn:www.agenziaentrate.gov.it:specificheTecniche:sco:730

type	DatoCB_Type
facets	Kind Value pattern [01]

element **Altri_Reddito_Ass_Lav_Type/ImportoRedditoAssimilato**

diagram	
namespace	urn:www.agenziaentrate.gov.it:specificheTecniche:sco:730
type	DatoNP_Type
facets	Kind Value pattern [1-9]{1}[0-9]*

complexType **Altri_Reddito_Diversi_Detr_Type**

diagram	
namespace	urn:www.agenziaentrate.gov.it:specificheTecniche:sco:730
children	m730:Tipo_Reddito m730:RedditiRitenuteSpese

element **Altri_Reddito_Diversi_Detr_Type/Tipo_Reddito**

diagram	
namespace	urn:www.agenziaentrate.gov.it:specificheTecniche:sco:730
type	m730:Tipo_Reddito_Da1a4_Type
facets	Kind Value pattern [1-9] enumeration 1 enumeration 2 enumeration 3 enumeration 4

element **Altri_Reddito_Diversi_Detr_Type/RedditiRitenuteSpese**

diagram	
---------	--

namespace	urn:www.agenziaentrate.gov.it:specificheTecniche:sco:730
type	m730:Redditi Ritenute Spese Type
children	m730:ImportoRedditi m730:ImportoRitenute m730:ImportoSpese

complexType Altri_Redditi_Diversi_Type

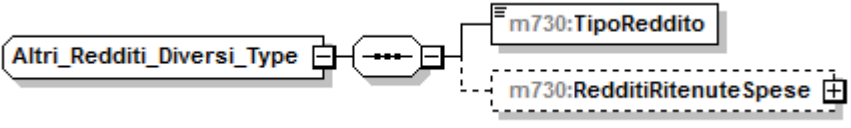
diagram	
namespace	urn:www.agenziaentrate.gov.it:specificheTecniche:sco:730
children	m730:TipoReddito m730:RedditiRitenuteSpese

element Altri_Redditi_Diversi_Type/TipoReddito

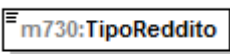
diagram																							
namespace	urn:www.agenziaentrate.gov.it:specificheTecniche:sco:730																						
type	m730:Tipo Reddito Da1a9 Type																						
facets	<table border="1"> <thead> <tr> <th>Kind</th> <th>Value</th> </tr> </thead> <tbody> <tr> <td>pattern</td> <td>[1-9]{1}[0-9]*</td> </tr> <tr> <td>enumeration</td> <td>1</td> </tr> <tr> <td>enumeration</td> <td>2</td> </tr> <tr> <td>enumeration</td> <td>3</td> </tr> <tr> <td>enumeration</td> <td>4</td> </tr> <tr> <td>enumeration</td> <td>5</td> </tr> <tr> <td>enumeration</td> <td>6</td> </tr> <tr> <td>enumeration</td> <td>7</td> </tr> <tr> <td>enumeration</td> <td>8</td> </tr> <tr> <td>enumeration</td> <td>9</td> </tr> </tbody> </table>	Kind	Value	pattern	[1-9]{1}[0-9]*	enumeration	1	enumeration	2	enumeration	3	enumeration	4	enumeration	5	enumeration	6	enumeration	7	enumeration	8	enumeration	9
Kind	Value																						
pattern	[1-9]{1}[0-9]*																						
enumeration	1																						
enumeration	2																						
enumeration	3																						
enumeration	4																						
enumeration	5																						
enumeration	6																						
enumeration	7																						
enumeration	8																						
enumeration	9																						

element Altri_Redditi_Diversi_Type/RedditiRitenuteSpese

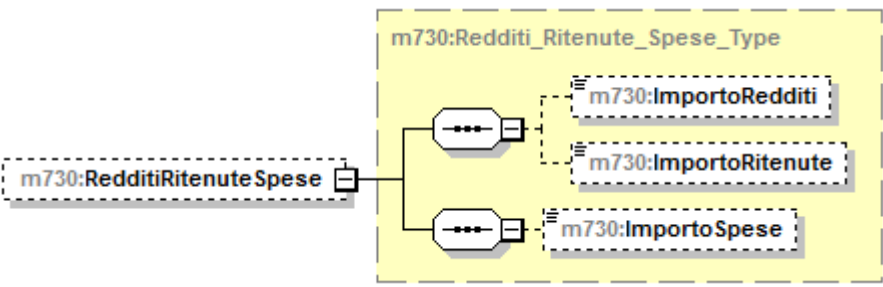
diagram	
namespace	urn:www.agenziaentrate.gov.it:specificheTecniche:sco:730
type	m730:Redditi Ritenute Spese Type
children	m730:ImportoRedditi m730:ImportoRitenute m730:ImportoSpese

complexType **Altri_Reddito_Lavoro_Autonomo_Type**

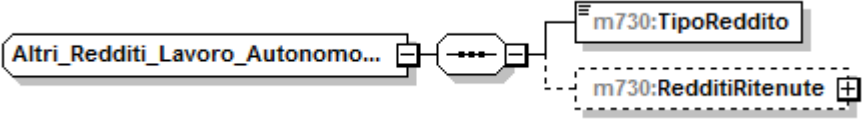
diagram	
namespace	urn:www.agenziaentrate.gov.it:specificheTecniche:sco:730
children	m730:TipoReddito m730:RedditiRitenute

element **Altri_Reddito_Lavoro_Autonomo_Type/TipoReddito**

diagram											
namespace	urn:www.agenziaentrate.gov.it:specificheTecniche:sco:730										
type	m730:Tipo_Reddito_Da1a3_Type										
facets	<table border="1"> <thead> <tr> <th>Kind</th> <th>Value</th> </tr> </thead> <tbody> <tr> <td>pattern</td> <td>[1-9]</td> </tr> <tr> <td>enumeration</td> <td>1</td> </tr> <tr> <td>enumeration</td> <td>2</td> </tr> <tr> <td>enumeration</td> <td>3</td> </tr> </tbody> </table>	Kind	Value	pattern	[1-9]	enumeration	1	enumeration	2	enumeration	3
Kind	Value										
pattern	[1-9]										
enumeration	1										
enumeration	2										
enumeration	3										

element **Altri_Reddito_Lavoro_Autonomo_Type/RedditiRitenute**

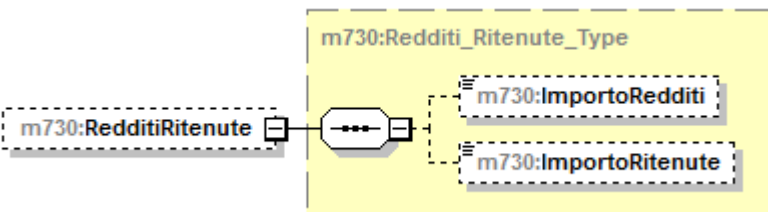
diagram	
namespace	urn:www.agenziaentrate.gov.it:specificheTecniche:sco:730
type	m730:Redditi_Ritenute_Type
children	m730:ImportoReddito m730:ImportoRitenute

complexType **Altri_Reddito_Type**

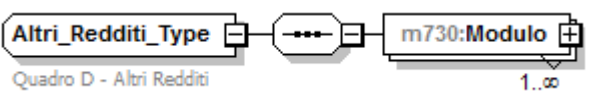
diagram	
namespace	urn:www.agenziaentrate.gov.it:specificheTecniche:sco:730
children	m730:Modulo

element **Altri_Reddito_Type/Modulo**

diagram	
namespace	urn:www.agenziaentrate.gov.it:specificheTecniche:sco:730
type	m730:Modulo_Altri_Reddito_Type
children	m730:RedditiDiCapitale m730:RedditiTassazioneSeparata

complexType **Altri_Reddito_Utili_Type**

diagram	
namespace	urn:www.agenziaentrate.gov.it:specificheTecniche:sco:730
children	m730:Tipo_Reddito m730:RedditiRitenute

element **Altri_Reddito_Utili_Type/Tipo_Reddito**

diagram																					
namespace	urn:www.agenziaentrate.gov.it:specificheTecniche:sco:730																				
type	m730:Tipo_Reddito_Da1a8_Type																				
facets	<table border="1"> <thead> <tr> <th>Kind</th> <th>Value</th> </tr> </thead> <tbody> <tr> <td>pattern</td> <td>[1-9]{1}[0-9]*</td> </tr> <tr> <td>enumeration</td> <td>1</td> </tr> <tr> <td>enumeration</td> <td>2</td> </tr> <tr> <td>enumeration</td> <td>3</td> </tr> <tr> <td>enumeration</td> <td>4</td> </tr> <tr> <td>enumeration</td> <td>5</td> </tr> <tr> <td>enumeration</td> <td>6</td> </tr> <tr> <td>enumeration</td> <td>7</td> </tr> <tr> <td>enumeration</td> <td>8</td> </tr> </tbody> </table>	Kind	Value	pattern	[1-9]{1}[0-9]*	enumeration	1	enumeration	2	enumeration	3	enumeration	4	enumeration	5	enumeration	6	enumeration	7	enumeration	8
Kind	Value																				
pattern	[1-9]{1}[0-9]*																				
enumeration	1																				
enumeration	2																				
enumeration	3																				
enumeration	4																				
enumeration	5																				
enumeration	6																				
enumeration	7																				
enumeration	8																				

element **Altri_Reddito_Utili_Type/RedditiRitenute**

diagram	
---------	--

element Annotazione_Type/Importo

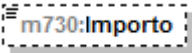
diagram					
namespace	urn:www.agenziaentrate.gov.it:specificheTecniche:sco:730				
type	DatoNP_Type				
facets	<table border="1"> <tr> <td>Kind</td> <td>Value</td> </tr> <tr> <td>pattern</td> <td>[1-9]{1}[0-9]*</td> </tr> </table>	Kind	Value	pattern	[1-9]{1}[0-9]*
Kind	Value				
pattern	[1-9]{1}[0-9]*				

complexType Assegno_Coniuge_Type

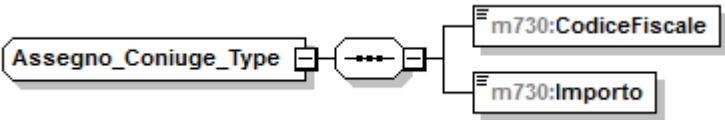
diagram	
namespace	urn:www.agenziaentrate.gov.it:specificheTecniche:sco:730
children	m730:CodiceFiscale m730:Importo

element Assegno_Coniuge_Type/CodiceFiscale

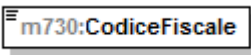
diagram					
namespace	urn:www.agenziaentrate.gov.it:specificheTecniche:sco:730				
type	DatoCF_Type				
facets	<table border="1"> <tr> <td>Kind</td> <td>Value</td> </tr> <tr> <td>pattern</td> <td>[0-9]{11}[[A-Z]{6}[0-9LMNPQRSTUVWXYZ]{2}[[A-Z]{1}[0-9LMNPQRSTUVWXYZ]{2}[[A-Z]{1}[0-9LMNPQRSTUVWXYZ]{3}[[A-Z]{1}</td> </tr> </table>	Kind	Value	pattern	[0-9]{11}[[A-Z]{6}[0-9LMNPQRSTUVWXYZ]{2}[[A-Z]{1}[0-9LMNPQRSTUVWXYZ]{2}[[A-Z]{1}[0-9LMNPQRSTUVWXYZ]{3}[[A-Z]{1}
Kind	Value				
pattern	[0-9]{11}[[A-Z]{6}[0-9LMNPQRSTUVWXYZ]{2}[[A-Z]{1}[0-9LMNPQRSTUVWXYZ]{2}[[A-Z]{1}[0-9LMNPQRSTUVWXYZ]{3}[[A-Z]{1}				

element Assegno_Coniuge_Type/Importo

diagram					
namespace	urn:www.agenziaentrate.gov.it:specificheTecniche:sco:730				
type	DatoNP_Type				
facets	<table border="1"> <tr> <td>Kind</td> <td>Value</td> </tr> <tr> <td>pattern</td> <td>[1-9]{1}[0-9]*</td> </tr> </table>	Kind	Value	pattern	[1-9]{1}[0-9]*
Kind	Value				
pattern	[1-9]{1}[0-9]*				

complexType **Bonus_Irpef_Type**

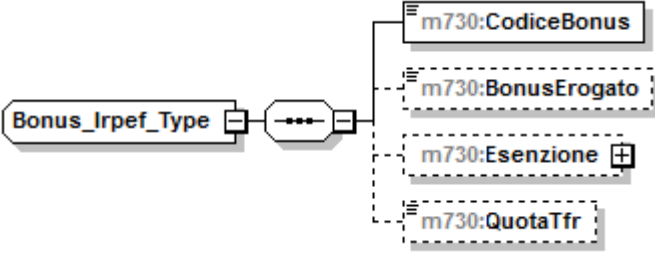
diagram	
namespace	urn:www.agenziaentrate.gov.it:specificheTecniche:sco:730
children	m730:CodiceBonus m730:BonusErogato m730:Esenzione m730:QuotaTfr

element **Bonus_Irpef_Type/CodiceBonus**

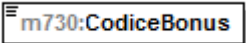
diagram									
namespace	urn:www.agenziaentrate.gov.it:specificheTecniche:sco:730								
type	restriction of DatoN1_Type								
facets	<table border="1"> <thead> <tr> <th>Kind</th> <th>Value</th> </tr> </thead> <tbody> <tr> <td>pattern</td> <td>[1-9]</td> </tr> <tr> <td>enumeration</td> <td>1</td> </tr> <tr> <td>enumeration</td> <td>2</td> </tr> </tbody> </table>	Kind	Value	pattern	[1-9]	enumeration	1	enumeration	2
Kind	Value								
pattern	[1-9]								
enumeration	1								
enumeration	2								

element **Bonus_Irpef_Type/BonusErogato**

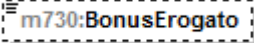
diagram					
namespace	urn:www.agenziaentrate.gov.it:specificheTecniche:sco:730				
type	DatoNP_Type				
facets	<table border="1"> <thead> <tr> <th>Kind</th> <th>Value</th> </tr> </thead> <tbody> <tr> <td>pattern</td> <td>[1-9]{1}[0-9]*</td> </tr> </tbody> </table>	Kind	Value	pattern	[1-9]{1}[0-9]*
Kind	Value				
pattern	[1-9]{1}[0-9]*				

element **Bonus_Irpef_Type/Esenzione**

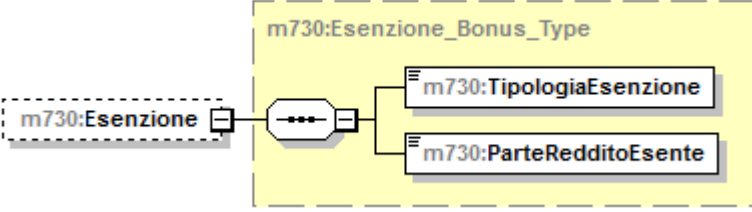
diagram	
namespace	urn:www.agenziaentrate.gov.it:specificheTecniche:sco:730
type	m730:Esenzione_Bonus_Type
children	m730:TipologiaEsenzione m730:ParteRedditoEsente

element **Bonus_Irpef_Type/QuotaTfr**

diagram					
namespace	urn:www.agenziaentrate.gov.it:specificheTecniche:sco:730				
type	DatoNP_Type				
facets	<table border="1"> <tr> <td>Kind</td> <td>Value</td> </tr> <tr> <td>pattern</td> <td>[1-9]{1}[0-9]*</td> </tr> </table>	Kind	Value	pattern	[1-9]{1}[0-9]*
Kind	Value				
pattern	[1-9]{1}[0-9]*				

complexType **Casella_Acconto_Type**

diagram	
namespace	urn:www.agenziaentrate.gov.it:specificheTecniche:sco:730
children	m730:Casella m730:ImportoMisuralInferiore

element **Casella_Acconto_Type/Casella**

diagram					
namespace	urn:www.agenziaentrate.gov.it:specificheTecniche:sco:730				
type	DatoCB_Type				
facets	<table border="1"> <tr> <td>Kind</td> <td>Value</td> </tr> <tr> <td>pattern</td> <td>[01]</td> </tr> </table>	Kind	Value	pattern	[01]
Kind	Value				
pattern	[01]				

element **Casella_Acconto_Type/ImportoMisuralInferiore**

diagram					
namespace	urn:www.agenziaentrate.gov.it:specificheTecniche:sco:730				
type	DatoNP_Type				
facets	<table border="1"> <tr> <td>Kind</td> <td>Value</td> </tr> <tr> <td>pattern</td> <td>[1-9]{1}[0-9]*</td> </tr> </table>	Kind	Value	pattern	[1-9]{1}[0-9]*
Kind	Value				
pattern	[1-9]{1}[0-9]*				

complexType **Cedolare_Secca_Type**

diagram	
---------	--

namespace	urn:www.agenziaentrate.gov.it:specificheTecniche:sco:730
children	m730:CedolareDovuta m730:EccezenzaCedolareSecca m730:AccontoCedolare

element **Cedolare_Secca_Type/CedolareDovuta**

diagram	
namespace	urn:www.agenziaentrate.gov.it:specificheTecniche:sco:730
type	DatoNP_Type
facets	Kind Value pattern [1-9]{1}[0-9]*

element **Cedolare_Secca_Type/EccezenzaCedolareSecca**

diagram	
namespace	urn:www.agenziaentrate.gov.it:specificheTecniche:sco:730
type	DatoNU_Type
facets	Kind Value pattern (\-[1-9] [1-9])[0-9]*

element **Cedolare_Secca_Type/AccontoCedolare**

diagram	
namespace	urn:www.agenziaentrate.gov.it:specificheTecniche:sco:730
type	DatoNP_Type
facets	Kind Value pattern [1-9]{1}[0-9]*

complexType **Comunicazione_Amministratore_Type**

diagram	
namespace	urn:www.agenziaentrate.gov.it:specificheTecniche:sco:730
children	m730:Module

element **Comunicazione_Administratore_Type/Modulo**

diagram	
namespace	urn:www.agenziaentrate.gov.it:specificheTecniche:sco:730
type	m730:Modulo_Comunicazione_Type
children	m730:DatiCondominio m730:DatiCatastali m730:DomandaAccatastamento m730:DatiFornitore

complexType **Conguaglio_Type**

diagram	
namespace	urn:www.agenziaentrate.gov.it:specificheTecniche:sco:730
children	m730:NumeroRate m730:ImportoTrattenutoSaldo m730:ImportoTrattenutoAcconto m730:ImportoDaVersareF24Saldo m730:ImportoDaVersareF24Acc... m730:ImportoRimborsato m730:ImportoRimborsatoAgenzia m730:OpzioneInformativa

element **Conguaglio_Type/NumeroRate**

diagram	
namespace	urn:www.agenziaentrate.gov.it:specificheTecniche:sco:730
type	restriction of DatoN1_Type

facets	Kind	Value
	pattern	[1-9]
	enumeration	2
	enumeration	3
	enumeration	4
	enumeration	5
	enumeration	6
enumeration	7	

element **Conguaglio_Type/ImportoTrattenutoSaldo**

diagram	 m730:ImportoTrattenutoSaldo				
namespace	urn:www.agenziaentrate.gov.it:specificheTecniche:sco:730				
type	DatoNP_Type				
facets	<table border="1"> <tr> <td>Kind</td> <td>Value</td> </tr> <tr> <td>pattern</td> <td>[1-9]{1}[0-9]*</td> </tr> </table>	Kind	Value	pattern	[1-9]{1}[0-9]*
Kind	Value				
pattern	[1-9]{1}[0-9]*				

element **Conguaglio_Type/ImportoTrattenutoAcconto**

diagram	 m730:ImportoTrattenutoAcconto				
namespace	urn:www.agenziaentrate.gov.it:specificheTecniche:sco:730				
type	DatoNP_Type				
facets	<table border="1"> <tr> <td>Kind</td> <td>Value</td> </tr> <tr> <td>pattern</td> <td>[1-9]{1}[0-9]*</td> </tr> </table>	Kind	Value	pattern	[1-9]{1}[0-9]*
Kind	Value				
pattern	[1-9]{1}[0-9]*				

element **Conguaglio_Type/ImportoDaVersareF24Saldo**

diagram	 m730:ImportoDaVersareF24Saldo				
namespace	urn:www.agenziaentrate.gov.it:specificheTecniche:sco:730				
type	DatoNP_Type				
facets	<table border="1"> <tr> <td>Kind</td> <td>Value</td> </tr> <tr> <td>pattern</td> <td>[1-9]{1}[0-9]*</td> </tr> </table>	Kind	Value	pattern	[1-9]{1}[0-9]*
Kind	Value				
pattern	[1-9]{1}[0-9]*				

element **Conguaglio_Type/ImportoDaVersareF24Acconto**

diagram	 m730:ImportoDaVersareF24Acc...				
namespace	urn:www.agenziaentrate.gov.it:specificheTecniche:sco:730				
type	DatoNP_Type				
facets	<table border="1"> <tr> <td>Kind</td> <td>Value</td> </tr> <tr> <td>pattern</td> <td>[1-9]{1}[0-9]*</td> </tr> </table>	Kind	Value	pattern	[1-9]{1}[0-9]*
Kind	Value				
pattern	[1-9]{1}[0-9]*				

element Conguaglio_Type/ImportoRimborsato

diagram					
namespace	urn:www.agenziaentrate.gov.it:specificheTecniche:sco:730				
type	DatoNP_Type				
facets	<table border="1"> <tr> <td>Kind</td> <td>Value</td> </tr> <tr> <td>pattern</td> <td>[1-9]{1}[0-9]*</td> </tr> </table>	Kind	Value	pattern	[1-9]{1}[0-9]*
Kind	Value				
pattern	[1-9]{1}[0-9]*				

element Conguaglio_Type/ImportoRimborsatoAgenzia

diagram					
namespace	urn:www.agenziaentrate.gov.it:specificheTecniche:sco:730				
type	DatoNP_Type				
facets	<table border="1"> <tr> <td>Kind</td> <td>Value</td> </tr> <tr> <td>pattern</td> <td>[1-9]{1}[0-9]*</td> </tr> </table>	Kind	Value	pattern	[1-9]{1}[0-9]*
Kind	Value				
pattern	[1-9]{1}[0-9]*				

element Conguaglio_Type/OpzioneInformativa

diagram					
namespace	urn:www.agenziaentrate.gov.it:specificheTecniche:sco:730				
type	DatoCB_Type				
facets	<table border="1"> <tr> <td>Kind</td> <td>Value</td> </tr> <tr> <td>pattern</td> <td>[01]</td> </tr> </table>	Kind	Value	pattern	[01]
Kind	Value				
pattern	[01]				

complexType Contributi_Previdenza_Complementare_Type

diagram	
namespace	urn:www.agenziaentrate.gov.it:specificheTecniche:sco:730
children	m730:EsclusiDalSostituto m730:NonEsclusiDalSostituto

element Contributi_Previdenza_Complementare_Type/EsclusiDalSostituto

diagram					
namespace	urn:www.agenziaentrate.gov.it:specificheTecniche:sco:730				
type	DatoNP_Type				
facets	<table border="1"> <tr> <td>Kind</td> <td>Value</td> </tr> <tr> <td>pattern</td> <td>[1-9]{1}[0-9]*</td> </tr> </table>	Kind	Value	pattern	[1-9]{1}[0-9]*
Kind	Value				
pattern	[1-9]{1}[0-9]*				

element **Contributi_Previdenza_Complementare_Type/NonEsclusiDalSostituto**

diagram					
namespace	urn:www.agenziaentrate.gov.it:specificheTecniche:sco:730				
type	DatoNP_Type				
facets	<table border="1"> <tr> <td>Kind</td> <td>Value</td> </tr> <tr> <td>pattern</td> <td>[1-9]{1}[0-9]*</td> </tr> </table>	Kind	Value	pattern	[1-9]{1}[0-9]*
Kind	Value				
pattern	[1-9]{1}[0-9]*				

complexType **Contributo_Solidarieta_Type**

diagram	
namespace	urn:www.agenziaentrate.gov.it:specificheTecniche:sco:730
children	m730:ImponibileContributo m730:ContributoDovuto m730:ContributoCertificaz

element **Contributo_Solidarieta_Type/ImponibileContributo**

diagram					
namespace	urn:www.agenziaentrate.gov.it:specificheTecniche:sco:730				
type	DatoNP_Type				
facets	<table border="1"> <tr> <td>Kind</td> <td>Value</td> </tr> <tr> <td>pattern</td> <td>[1-9]{1}[0-9]*</td> </tr> </table>	Kind	Value	pattern	[1-9]{1}[0-9]*
Kind	Value				
pattern	[1-9]{1}[0-9]*				

element **Contributo_Solidarieta_Type/ContributoDovuto**

diagram					
namespace	urn:www.agenziaentrate.gov.it:specificheTecniche:sco:730				
type	DatoNP_Type				
facets	<table border="1"> <tr> <td>Kind</td> <td>Value</td> </tr> <tr> <td>pattern</td> <td>[1-9]{1}[0-9]*</td> </tr> </table>	Kind	Value	pattern	[1-9]{1}[0-9]*
Kind	Value				
pattern	[1-9]{1}[0-9]*				

element **Contributo_Solidarieta_Type/ContributoCertificaz**

diagram	
namespace	urn:www.agenziaentrate.gov.it:specificheTecniche:sco:730

type	DatoNP_Type
facets	Kind Value pattern [1-9]{1}[0-9]*

complexType Cred_Erogazione_Cultura_Type

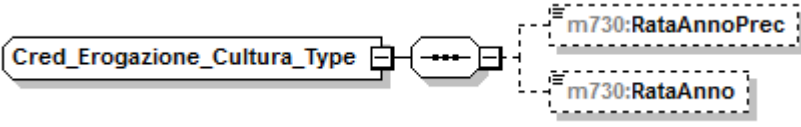
diagram	
namespace	urn:www.agenziaentrate.gov.it:specificheTecniche:sco:730
children	m730:RataAnnoPrec m730:RataAnno

element Cred_Erogazione_Cultura_Type/RataAnnoPrec

diagram	
namespace	urn:www.agenziaentrate.gov.it:specificheTecniche:sco:730
type	DatoNP_Type
facets	Kind Value pattern [1-9]{1}[0-9]*

element Cred_Erogazione_Cultura_Type/RataAnno

diagram	
namespace	urn:www.agenziaentrate.gov.it:specificheTecniche:sco:730
type	DatoNP_Type
facets	Kind Value pattern [1-9]{1}[0-9]*

complexType Cred_Imp_Estero_Type

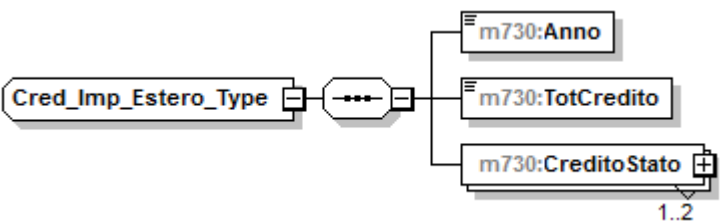
diagram	
namespace	urn:www.agenziaentrate.gov.it:specificheTecniche:sco:730
children	m730:Anno m730:TotCredito m730:CreditoStato

element **Cred_Imp_Estero_Type/Anno**

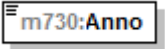
diagram	
namespace	urn:www.agenziaentrate.gov.it:specificheTecniche:sco:730
type	DatoDA_Type
facets	Kind Value pattern (18 19 20)[0-9]{2}

element **Cred_Imp_Estero_Type/TotCredito**

diagram	
namespace	urn:www.agenziaentrate.gov.it:specificheTecniche:sco:730
type	DatoNP_Type
facets	Kind Value pattern [1-9]{1}[0-9]*

element **Cred_Imp_Estero_Type/CreditoStato**

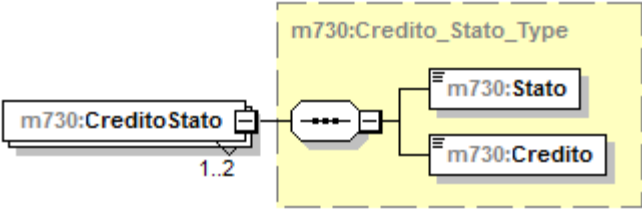
diagram	
namespace	urn:www.agenziaentrate.gov.it:specificheTecniche:sco:730
type	m730:Credito_Stato_Type
children	m730:Stato m730:Credito

complexType **Crediti_F24_Type**

diagram	
namespace	urn:www.agenziaentrate.gov.it:specificheTecniche:sco:730
children	m730:Credlrpef m730:CredlrpefDipNoSostituto m730:CodAddReg m730:CredAddReg m730:CredAddRegDipNoSostituto m730:CodiceAddCom m730:CredAddCom m730:CredAddComDipNoSostituto m730:CredCedolare m730:CredCedolareDipNoSostituto m730:CredTassSeparDipNoSostituto m730:CredSolidarietaDipNoSostituto m730:Totale m730:TotaleDipNoSostituto

element **Crediti_F24_Type/Credlrpef**

diagram					
namespace	urn:www.agenziaentrate.gov.it:specificheTecniche:sco:730				
type	DatoNP_Type				
facets	<table border="1"> <tr> <td>Kind</td> <td>Value</td> </tr> <tr> <td>pattern</td> <td>[1-9]{1}[0-9]*</td> </tr> </table>	Kind	Value	pattern	[1-9]{1}[0-9]*
Kind	Value				
pattern	[1-9]{1}[0-9]*				

element **Crediti_F24_Type/CredlrpefDipNoSostituto**

diagram	
---------	--

namespace	urn:www.agenziaentrate.gov.it:specificheTecniche:sco:730
type	DatoNP_Type
facets	Kind Value pattern [1-9]{1}[0-9]*

element **Crediti_F24_Type/CodAddReg**

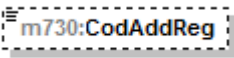
diagram	
namespace	urn:www.agenziaentrate.gov.it:specificheTecniche:sco:730
type	Codice Regione Type
facets	Kind Value pattern {[0-9A-Z-]]"}{1}([0-9A-Z&]] ^- . . ° ^\\(\\) À È É Ì Ò Ù Ü ";\\ \\ \\+)* enumeration 1 enumeration 2 enumeration 3 enumeration 4 enumeration 5 enumeration 6 enumeration 7 enumeration 8 enumeration 9 enumeration 10 enumeration 11 enumeration 12 enumeration 13 enumeration 14 enumeration 15 enumeration 16 enumeration 17 enumeration 18 enumeration 19 enumeration 20 enumeration 21

element **Crediti_F24_Type/CredAddReg**

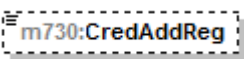
diagram	
namespace	urn:www.agenziaentrate.gov.it:specificheTecniche:sco:730
type	DatoNP_Type
facets	Kind Value pattern [1-9]{1}[0-9]*

element **Crediti_F24_Type/CredAddRegDipNoSostituto**

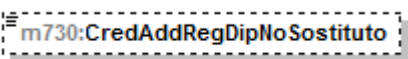
diagram	
namespace	urn:www.agenziaentrate.gov.it:specificheTecniche:sco:730
type	DatoNP_Type
facets	Kind Value pattern [1-9]{1}[0-9]*

element Crediti_F24_Type/CodiceAddCom

diagram	 m730:CodiceAddCom
namespace	urn:www.agenziaentrate.gov.it:specificheTecniche:sco:730
type	DatoAN_Type
facets	Kind Value pattern ([0-9A-Z- "}{1}{[0-9A-Z&:] "- \. , / "^\(\\)À È É Ì Ò Ù Ú " \\ / +)*

element Crediti_F24_Type/CredAddCom

diagram	 m730:CredAddCom
namespace	urn:www.agenziaentrate.gov.it:specificheTecniche:sco:730
type	DatoNP_Type
facets	Kind Value pattern [1-9]{1}[0-9]*

element Crediti_F24_Type/CredAddComDipNoSostituto

diagram	 m730:CredAddComDipNo Sostitu...
namespace	urn:www.agenziaentrate.gov.it:specificheTecniche:sco:730
type	DatoNP_Type
facets	Kind Value pattern [1-9]{1}[0-9]*

element Crediti_F24_Type/CredCedolare

diagram	 m730:CredCedolare
namespace	urn:www.agenziaentrate.gov.it:specificheTecniche:sco:730
type	DatoNP_Type
facets	Kind Value pattern [1-9]{1}[0-9]*

element Crediti_F24_Type/CredCedolareDipNoSostituto

diagram	 m730:CredCedolareDipNo Sostit...
namespace	urn:www.agenziaentrate.gov.it:specificheTecniche:sco:730
type	DatoNP_Type

facets	Kind	Value
	pattern	[1-9]{1}[0-9]*

element Crediti_F24_Type/CredTassSeparDipNoSostituto

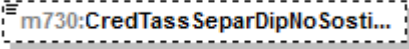
diagram		
namespace	urn:www.agenziaentrate.gov.it:specificheTecniche:sco:730	
type	DatoNP_Type	
facets	Kind	Value
	pattern	[1-9]{1}[0-9]*

element Crediti_F24_Type/CredSolidarietaDipNoSostituto

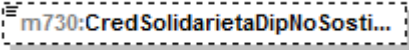
diagram		
namespace	urn:www.agenziaentrate.gov.it:specificheTecniche:sco:730	
type	DatoNP_Type	
facets	Kind	Value
	pattern	[1-9]{1}[0-9]*

element Crediti_F24_Type/Totale

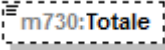
diagram		
namespace	urn:www.agenziaentrate.gov.it:specificheTecniche:sco:730	
type	DatoNP_Type	
facets	Kind	Value
	pattern	[1-9]{1}[0-9]*

element Crediti_F24_Type/TotaleDipNoSostituto

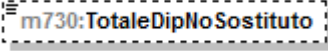
diagram		
namespace	urn:www.agenziaentrate.gov.it:specificheTecniche:sco:730	
type	DatoNP_Type	
facets	Kind	Value
	pattern	[1-9]{1}[0-9]*

complexType **Crediti_Imposta_Altri_Sisma_Abruzzo_Type**

diagram	
namespace	urn:www.agenziaentrate.gov.it:specificheTecniche:sco:730
children	m730:Impresa_Professione m730:CreditoImmobileSismaAbruzzo m730:Rateazione

element **Crediti_Imposta_Altri_Sisma_Abruzzo_Type/Impresa_Professione**

diagram					
namespace	urn:www.agenziaentrate.gov.it:specificheTecniche:sco:730				
type	DatoCB_Type				
facets	<table border="1"> <thead> <tr> <th>Kind</th> <th>Value</th> </tr> </thead> <tbody> <tr> <td>pattern</td> <td>[01]</td> </tr> </tbody> </table>	Kind	Value	pattern	[01]
Kind	Value				
pattern	[01]				

element **Crediti_Imposta_Altri_Sisma_Abruzzo_Type/CreditoImmobileSismaAbruzzo**

diagram	
namespace	urn:www.agenziaentrate.gov.it:specificheTecniche:sco:730
type	m730:Credito_Immibile_Sisma_Abruzzo_Type
children	m730:CodiceFiscale m730:NumeroRata m730:TotaleCredito

element **Crediti_Imposta_Altri_Sisma_Abruzzo_Type/Rateazione**

diagram									
namespace	urn:www.agenziaentrate.gov.it:specificheTecniche:sco:730								
type	m730:Numero_Rate5o10_Type								
facets	<table border="1"> <thead> <tr> <th>Kind</th> <th>Value</th> </tr> </thead> <tbody> <tr> <td>pattern</td> <td>[1-9]{1}[0-9]*</td> </tr> <tr> <td>enumeration</td> <td>5</td> </tr> <tr> <td>enumeration</td> <td>10</td> </tr> </tbody> </table>	Kind	Value	pattern	[1-9]{1}[0-9]*	enumeration	5	enumeration	10
Kind	Value								
pattern	[1-9]{1}[0-9]*								
enumeration	5								
enumeration	10								

complexType **Crediti_Imposta_Fabbicati_Type**

diagram	
namespace	urn:www.agenziaentrate.gov.it:specificheTecniche:sco:730
children	m730:ResiduoFabbicati m730:CanoniLocazioneNonPercepiti

element **Crediti_Imposta_Fabbicati_Type/ResiduoFabbicati**

diagram	
namespace	urn:www.agenziaentrate.gov.it:specificheTecniche:sco:730
type	m730:Residuo_Fabbicati_Type
children	m730:ResiduoPrecedenteDichiarazione m730:CreditoAnno m730:DiCuiCompensatoF24

element **Crediti_Imposta_Fabbicati_Type/CanoniLocazioneNonPercepiti**

diagram					
namespace	urn:www.agenziaentrate.gov.it:specificheTecniche:sco:730				
type	DatoNP_Type				
facets	<table border="1"> <thead> <tr> <th>Kind</th> <th>Value</th> </tr> </thead> <tbody> <tr> <td>pattern</td> <td>[1-9]{1}[0-9]*</td> </tr> </tbody> </table>	Kind	Value	pattern	[1-9]{1}[0-9]*
Kind	Value				
pattern	[1-9]{1}[0-9]*				

complexType **Crediti_Imposta_Fondi_Pensione_Type**

diagram	
namespace	urn:www.agenziaentrate.gov.it:specificheTecniche:sco:730

children	m730:AnnoAnticipazione m730:Reintegro m730:SommaReintegrata m730:CreditoAnno
----------	--

element **Crediti_Imposta_Fondi_Pensione_Type/AnnoAnticipazione**

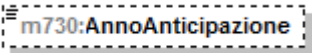
diagram																							
namespace	urn:www.agenziaentrate.gov.it:specificheTecniche:sco:730																						
type	m730:Anno Anticipazione Fondo Pensione Type																						
facets	<table border="1"> <thead> <tr> <th>Kind</th> <th>Value</th> </tr> </thead> <tbody> <tr> <td>pattern</td> <td>[1-9]{1}[0-9]*</td> </tr> <tr> <td>enumeration</td> <td>2007</td> </tr> <tr> <td>enumeration</td> <td>2008</td> </tr> <tr> <td>enumeration</td> <td>2009</td> </tr> <tr> <td>enumeration</td> <td>2010</td> </tr> <tr> <td>enumeration</td> <td>2011</td> </tr> <tr> <td>enumeration</td> <td>2012</td> </tr> <tr> <td>enumeration</td> <td>2013</td> </tr> <tr> <td>enumeration</td> <td>2014</td> </tr> <tr> <td>enumeration</td> <td>2015</td> </tr> </tbody> </table>	Kind	Value	pattern	[1-9]{1}[0-9]*	enumeration	2007	enumeration	2008	enumeration	2009	enumeration	2010	enumeration	2011	enumeration	2012	enumeration	2013	enumeration	2014	enumeration	2015
Kind	Value																						
pattern	[1-9]{1}[0-9]*																						
enumeration	2007																						
enumeration	2008																						
enumeration	2009																						
enumeration	2010																						
enumeration	2011																						
enumeration	2012																						
enumeration	2013																						
enumeration	2014																						
enumeration	2015																						

element **Crediti_Imposta_Fondi_Pensione_Type/Reintegro**

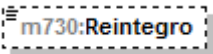
diagram									
namespace	urn:www.agenziaentrate.gov.it:specificheTecniche:sco:730								
type	m730:Reintegro Totale Parziale Type								
facets	<table border="1"> <thead> <tr> <th>Kind</th> <th>Value</th> </tr> </thead> <tbody> <tr> <td>pattern</td> <td>[1-9]</td> </tr> <tr> <td>enumeration</td> <td>1</td> </tr> <tr> <td>enumeration</td> <td>2</td> </tr> </tbody> </table>	Kind	Value	pattern	[1-9]	enumeration	1	enumeration	2
Kind	Value								
pattern	[1-9]								
enumeration	1								
enumeration	2								

element **Crediti_Imposta_Fondi_Pensione_Type/SommaReintegrata**

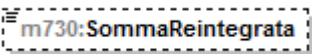
diagram					
namespace	urn:www.agenziaentrate.gov.it:specificheTecniche:sco:730				
type	DatoNP Type				
facets	<table border="1"> <thead> <tr> <th>Kind</th> <th>Value</th> </tr> </thead> <tbody> <tr> <td>pattern</td> <td>[1-9]{1}[0-9]*</td> </tr> </tbody> </table>	Kind	Value	pattern	[1-9]{1}[0-9]*
Kind	Value				
pattern	[1-9]{1}[0-9]*				

element **Crediti_Imposta_Fondi_Pensione_Type/CreditoAnno**

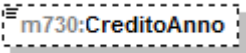
diagram					
namespace	urn:www.agenziaentrate.gov.it:specificheTecniche:sco:730				
type	DatoNP Type				
facets	<table border="1"> <thead> <tr> <th>Kind</th> <th>Value</th> </tr> </thead> <tbody> <tr> <td>pattern</td> <td>[1-9]{1}[0-9]*</td> </tr> </tbody> </table>	Kind	Value	pattern	[1-9]{1}[0-9]*
Kind	Value				
pattern	[1-9]{1}[0-9]*				

complexType **Crediti_Imposta_Redditi_Esteri_Type**

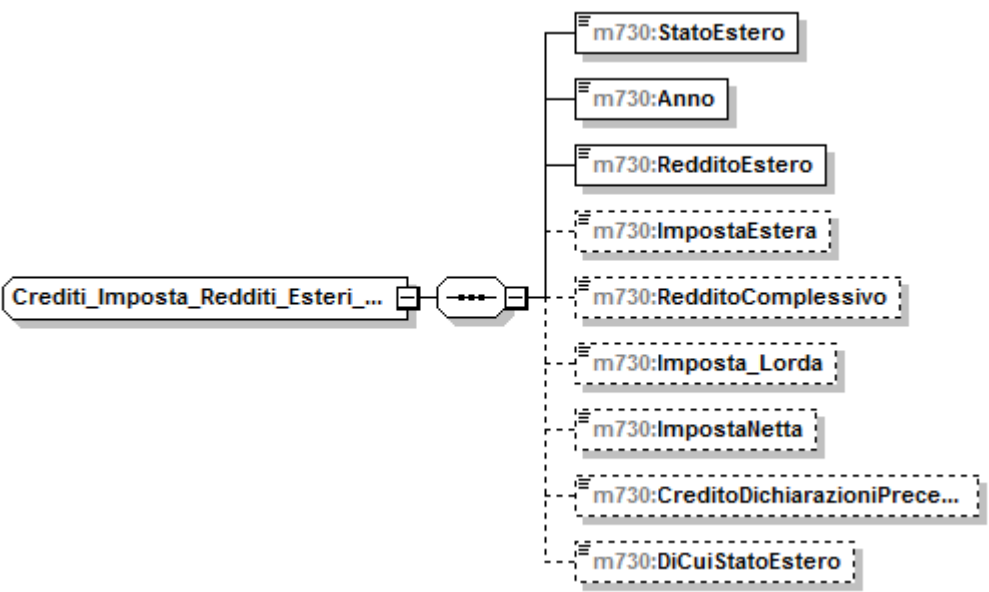
diagram	
namespace	urn:www.agenziaentrate.gov.it:specificheTecniche:sco:730
children	m730:StatoEstero m730:Anno m730:RedditoEstero m730:ImpostaEsteri m730:RedditoComplessivo m730:Imposta_Lorda m730:ImpostaNetta m730:CreditoDichiarazioniPrecedenti m730:DiCuiStatoEstero

element **Crediti_Imposta_Redditi_Esteri_Type/StatoEstero**

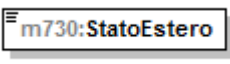
diagram					
namespace	urn:www.agenziaentrate.gov.it:specificheTecniche:sco:730				
type	DatoAN_Type				
facets	<table border="1"> <thead> <tr> <th>Kind</th> <th>Value</th> </tr> </thead> <tbody> <tr> <td>pattern</td> <td>([0-9A-Z\-\]]&quot;){1}([0-9A-Z&amp;:] \- \., / ^ \^\(\ \)\ À É È Ì Ò Ù Ü &quot; \\ \ +)*</td> </tr> </tbody> </table>	Kind	Value	pattern	([0-9A-Z\-\]]"){1}([0-9A-Z&:] \- \., / ^ \^\(\ \)\ À É È Ì Ò Ù Ü " \\ \ +)*
Kind	Value				
pattern	([0-9A-Z\-\]]"){1}([0-9A-Z&:] \- \., / ^ \^\(\ \)\ À É È Ì Ò Ù Ü " \\ \ +)*				

element **Crediti_Imposta_Redditi_Esteri_Type/Anno**

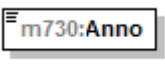
diagram					
namespace	urn:www.agenziaentrate.gov.it:specificheTecniche:sco:730				
type	restriction of DatoDA_Type				
facets	<table border="1"> <thead> <tr> <th>Kind</th> <th>Value</th> </tr> </thead> <tbody> <tr> <td>pattern</td> <td>(18 19 20)[0-9]{2}</td> </tr> </tbody> </table>	Kind	Value	pattern	(18 19 20)[0-9]{2}
Kind	Value				
pattern	(18 19 20)[0-9]{2}				

element **Crediti_Imposta_Redditi_Esteri_Type/RedditoEstero**

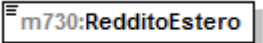
diagram	
namespace	urn:www.agenziaentrate.gov.it:specificheTecniche:sco:730
type	DatoNP_Type
facets	Kind Value pattern [1-9]{1}[0-9]*

element **Crediti_Imposta_Redditi_Esteri_Type/ImpostaEstera**

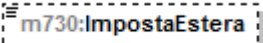
diagram	
namespace	urn:www.agenziaentrate.gov.it:specificheTecniche:sco:730
type	DatoNP_Type
facets	Kind Value pattern [1-9]{1}[0-9]*

element **Crediti_Imposta_Redditi_Esteri_Type/RedditoComplessivo**

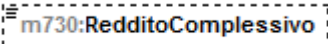
diagram	
namespace	urn:www.agenziaentrate.gov.it:specificheTecniche:sco:730
type	DatoNP_Type
facets	Kind Value pattern [1-9]{1}[0-9]*

element **Crediti_Imposta_Redditi_Esteri_Type/Imposta_Lorda**

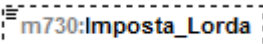
diagram	
namespace	urn:www.agenziaentrate.gov.it:specificheTecniche:sco:730
type	DatoNP_Type
facets	Kind Value pattern [1-9]{1}[0-9]*

element **Crediti_Imposta_Redditi_Esteri_Type/ImpostaNetta**

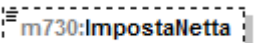
diagram	
namespace	urn:www.agenziaentrate.gov.it:specificheTecniche:sco:730
type	DatoNP_Type
facets	Kind Value pattern [1-9]{1}[0-9]*

element **Crediti_Imposta_Redditi_Esteri_Type/CreditoDichiarazioniPrecedenti**

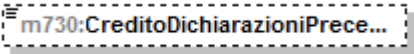
diagram	
namespace	urn:www.agenziaentrate.gov.it:specificheTecniche:sco:730
type	DatoNP_Type
facets	Kind Value pattern [1-9]{1}[0-9]*

element **Crediti_Imposta_Redditi_Esteri_Type/DiCuiStatoEstero**

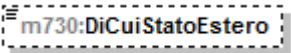
diagram	
namespace	urn:www.agenziaentrate.gov.it:specificheTecniche:sco:730
type	DatoNP_Type
facets	Kind Value pattern [1-9]{1}[0-9]*

complexType **Crediti_Imposta_Type**

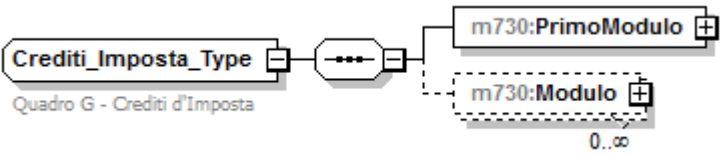
diagram	
namespace	urn:www.agenziaentrate.gov.it:specificheTecniche:sco:730
children	m730:PrimoModulo m730:Modulo

element **Crediti_Imposta_Type/PrimoModulo**

<p>diagram</p>	
<p>namespace</p>	<p>urn:www.agenziaentrate.gov.it:specificheTecniche:sco:730</p>
<p>type</p>	<p>m730:Primo_Modulo_Crediti_Imposta_Type</p>
<p>children</p>	<p>m730:CreditoImpostaFabbricati m730:CreditoImpostaFondiPensione m730:CreditoImpostaRedditiEsteri m730:CreditoPrimaCasaSismaAbruzzo m730:CreditoAltriSismaAbruzzo m730:CreditoIncrementoOccupazione m730:CreditoImpostaMediazioni m730:CreditoErogazioniCultura m730:CreditoNegoziazione</p>

element **Crediti_Imposta_Type/Modulo**

<p>diagram</p>	
<p>namespace</p>	<p>urn:www.agenziaentrate.gov.it:specificheTecniche:sco:730</p>
<p>type</p>	<p>m730:Modulo_Crediti_Imposta_Type</p>
<p>children</p>	<p>m730:CreditoImpostaFondiPensione m730:CreditoImpostaRedditiEsteri m730:CreditoPrimaCasaSismaAbruzzo m730:CreditoAltriSismaAbruzzo m730:CreditoNegoziazione</p>

complexType Credito_Erogazioni_Cultura_Type

diagram	
namespace	urn:www.agenziaentrate.gov.it:specificheTecniche:sco:730
children	m730:SpesaAnno m730:ResiduoAnnoPrec m730:RataAnnoPrec

element Credito_Erogazioni_Cultura_Type/SpesaAnno

diagram					
namespace	urn:www.agenziaentrate.gov.it:specificheTecniche:sco:730				
type	DatoNP_Type				
facets	<table border="1"> <tr> <td>Kind</td> <td>Value</td> </tr> <tr> <td>pattern</td> <td>[1-9]{1}[0-9]*</td> </tr> </table>	Kind	Value	pattern	[1-9]{1}[0-9]*
Kind	Value				
pattern	[1-9]{1}[0-9]*				

element Credito_Erogazioni_Cultura_Type/ResiduoAnnoPrec

diagram					
namespace	urn:www.agenziaentrate.gov.it:specificheTecniche:sco:730				
type	DatoNP_Type				
facets	<table border="1"> <tr> <td>Kind</td> <td>Value</td> </tr> <tr> <td>pattern</td> <td>[1-9]{1}[0-9]*</td> </tr> </table>	Kind	Value	pattern	[1-9]{1}[0-9]*
Kind	Value				
pattern	[1-9]{1}[0-9]*				

element Credito_Erogazioni_Cultura_Type/RataAnnoPrec

diagram					
namespace	urn:www.agenziaentrate.gov.it:specificheTecniche:sco:730				
type	DatoNP_Type				
facets	<table border="1"> <tr> <td>Kind</td> <td>Value</td> </tr> <tr> <td>pattern</td> <td>[1-9]{1}[0-9]*</td> </tr> </table>	Kind	Value	pattern	[1-9]{1}[0-9]*
Kind	Value				
pattern	[1-9]{1}[0-9]*				

complexType **Credito_Immibile_Sisma_Abruzzo_Type**

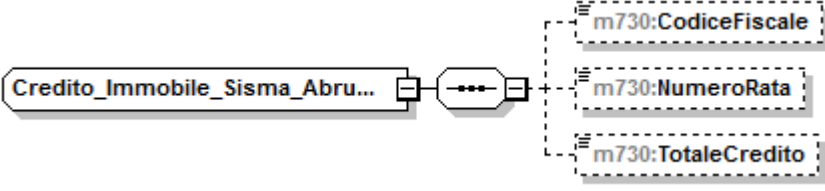
diagram	
namespace	urn:www.agenziaentrate.gov.it:specificheTecniche:sco:730
children	m730:CodiceFiscale m730:NumeroRata m730:TotaleCredito

element **Credito_Immibile_Sisma_Abruzzo_Type/CodiceFiscale**

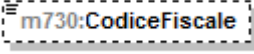
diagram					
namespace	urn:www.agenziaentrate.gov.it:specificheTecniche:sco:730				
type	DatoCF_Type				
facets	<table border="1"> <thead> <tr> <th>Kind</th> <th>Value</th> </tr> </thead> <tbody> <tr> <td>pattern</td> <td>[0-9]{11}[A-Z]{6}[0-9LMNPQRSTU]{2}[A-Z]{1}[0-9LMNPQRSTU]{2}[A-Z]{1}[0-9LMNPQRSTU]{3}[A-Z]{1}</td> </tr> </tbody> </table>	Kind	Value	pattern	[0-9]{11}[A-Z]{6}[0-9LMNPQRSTU]{2}[A-Z]{1}[0-9LMNPQRSTU]{2}[A-Z]{1}[0-9LMNPQRSTU]{3}[A-Z]{1}
Kind	Value				
pattern	[0-9]{11}[A-Z]{6}[0-9LMNPQRSTU]{2}[A-Z]{1}[0-9LMNPQRSTU]{2}[A-Z]{1}[0-9LMNPQRSTU]{3}[A-Z]{1}				

element **Credito_Immibile_Sisma_Abruzzo_Type/NumeroRata**

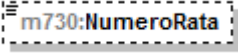
diagram																			
namespace	urn:www.agenziaentrate.gov.it:specificheTecniche:sco:730																		
type	m730:Numero_RateDa1A7_Type																		
facets	<table border="1"> <thead> <tr> <th>Kind</th> <th>Value</th> </tr> </thead> <tbody> <tr> <td>pattern</td> <td>[1-9]</td> </tr> <tr> <td>enumeration</td> <td>1</td> </tr> <tr> <td>enumeration</td> <td>2</td> </tr> <tr> <td>enumeration</td> <td>3</td> </tr> <tr> <td>enumeration</td> <td>4</td> </tr> <tr> <td>enumeration</td> <td>5</td> </tr> <tr> <td>enumeration</td> <td>6</td> </tr> <tr> <td>enumeration</td> <td>7</td> </tr> </tbody> </table>	Kind	Value	pattern	[1-9]	enumeration	1	enumeration	2	enumeration	3	enumeration	4	enumeration	5	enumeration	6	enumeration	7
Kind	Value																		
pattern	[1-9]																		
enumeration	1																		
enumeration	2																		
enumeration	3																		
enumeration	4																		
enumeration	5																		
enumeration	6																		
enumeration	7																		

element **Credito_Immibile_Sisma_Abruzzo_Type/TotaleCredito**

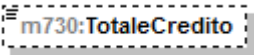
diagram					
namespace	urn:www.agenziaentrate.gov.it:specificheTecniche:sco:730				
type	DatoNP_Type				
facets	<table border="1"> <thead> <tr> <th>Kind</th> <th>Value</th> </tr> </thead> <tbody> <tr> <td>pattern</td> <td>[1-9]{1}[0-9]*</td> </tr> </tbody> </table>	Kind	Value	pattern	[1-9]{1}[0-9]*
Kind	Value				
pattern	[1-9]{1}[0-9]*				

complexType **Credito_Incremento_Occupazione_Type**

diagram	
namespace	urn:www.agenziaentrate.gov.it:specificheTecniche:sco:730
children	m730:ResiduoPrecedenteDichiarazione m730:DiCuiCompensatoF24

element **Credito_Incremento_Occupazione_Type/ResiduoPrecedenteDichiarazione**

diagram	
namespace	urn:www.agenziaentrate.gov.it:specificheTecniche:sco:730
type	DatoNP_Type
facets	Kind Value pattern [1-9]{1}[0-9]*

element **Credito_Incremento_Occupazione_Type/DiCuiCompensatoF24**

diagram	
namespace	urn:www.agenziaentrate.gov.it:specificheTecniche:sco:730
type	DatoNP_Type
facets	Kind Value pattern [1-9]{1}[0-9]*

complexType **Credito_Negoziatore_Type**

diagram	
namespace	urn:www.agenziaentrate.gov.it:specificheTecniche:sco:730
children	m730:CreditoSpettante m730:DiCuiCompensatoF24

element **Credito_Negoziatore_Type/CreditoSpettante**

diagram	
namespace	urn:www.agenziaentrate.gov.it:specificheTecniche:sco:730
type	DatoNP_Type
facets	Kind Value pattern [1-9]{1}[0-9]*

element Credito_Negoziazione_Type/DiCuiCompensatoF24

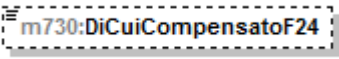
diagram	
namespace	urn:www.agenziaentrate.gov.it:specificheTecniche:sco:730
type	DatoNP_Type
facets	Kind Value pattern [1-9]{1}[0-9]*

complexType Credito_Stato_Type

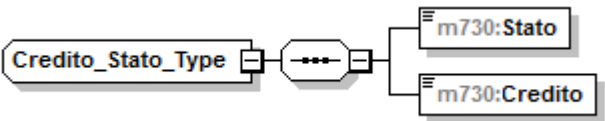
diagram	
namespace	urn:www.agenziaentrate.gov.it:specificheTecniche:sco:730
children	m730:Stato m730:Credito

element Credito_Stato_Type/Stato

diagram	
namespace	urn:www.agenziaentrate.gov.it:specificheTecniche:sco:730
type	DatoAN_Type
facets	Kind Value pattern (([0-9A-Z- "]){1}([0-9A-Z&:] "- \., / "^\(\ \)\À É Ê Ë Ì Ò Ù Û Ü " \N \ +)*

element Credito_Stato_Type/Credito

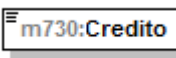
diagram	
namespace	urn:www.agenziaentrate.gov.it:specificheTecniche:sco:730
type	DatoNP_Type
facets	Kind Value pattern [1-9]{1}[0-9]*

complexType Credito_Type

diagram	
namespace	urn:www.agenziaentrate.gov.it:specificheTecniche:sco:730
children	m730:NonRimborsabile m730:Credito m730:CreditoF24 m730:CreditoRimborso

element Credito_Type/NonRimborsabile

diagram					
namespace	urn:www.agenziaentrate.gov.it:specificheTecniche:sco:730				
type	DatoNP_Type				
facets	<table border="1"> <tr> <td>Kind</td> <td>Value</td> </tr> <tr> <td>pattern</td> <td>[1-9]{1}[0-9]*</td> </tr> </table>	Kind	Value	pattern	[1-9]{1}[0-9]*
Kind	Value				
pattern	[1-9]{1}[0-9]*				

element Credito_Type/Credito

diagram					
namespace	urn:www.agenziaentrate.gov.it:specificheTecniche:sco:730				
type	DatoNP_Type				
facets	<table border="1"> <tr> <td>Kind</td> <td>Value</td> </tr> <tr> <td>pattern</td> <td>[1-9]{1}[0-9]*</td> </tr> </table>	Kind	Value	pattern	[1-9]{1}[0-9]*
Kind	Value				
pattern	[1-9]{1}[0-9]*				

element Credito_Type/CreditoF24

diagram					
namespace	urn:www.agenziaentrate.gov.it:specificheTecniche:sco:730				
type	DatoNP_Type				
facets	<table border="1"> <tr> <td>Kind</td> <td>Value</td> </tr> <tr> <td>pattern</td> <td>[1-9]{1}[0-9]*</td> </tr> </table>	Kind	Value	pattern	[1-9]{1}[0-9]*
Kind	Value				
pattern	[1-9]{1}[0-9]*				

element Credito_Type/CreditoRimborso

diagram	
namespace	urn:www.agenziaentrate.gov.it:specificheTecniche:sco:730

type	DatoNP_Type
facets	Kind Value pattern [1-9]{1}[0-9]*

complexType [Dati_730_Integrativo_Type](#)

diagram	
namespace	urn:www.agenziaentrate.gov.it:specificheTecniche:sco:730
children	m730:Rimborso m730:Credito

element [Dati_730_Integrativo_Type/Rimborso](#)

diagram	
namespace	urn:www.agenziaentrate.gov.it:specificheTecniche:sco:730
type	m730:Elemento_Integrativo_Type
children	m730:lrpef m730:AddizionaleRegionalelrpef m730:AddComunalelrpef m730:CedolareSecca

element [Dati_730_Integrativo_Type/Credito](#)

diagram	
namespace	urn:www.agenziaentrate.gov.it:specificheTecniche:sco:730
type	m730:Elemento_Integrativo_Type

children	m730:Irpef m730:AddizionaleRegionaleIrpef m730:AddComunaleIrpef m730:CedolareSecca
----------	--

complexType **Dati_Altre_Detrazioni_Modulo_Type**

diagram	
namespace	urn:www.agenziaentrate.gov.it:specificheTecniche:sco:730
children	m730:AltreDetrazioni

element **Dati_Altre_Detrazioni_Modulo_Type/AltreDetrazioni**

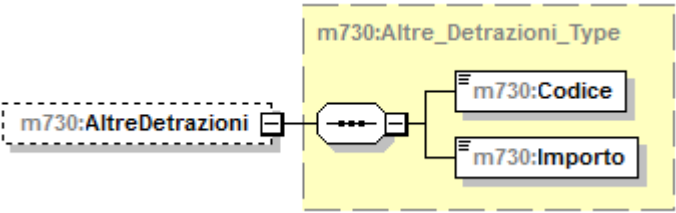
diagram	
namespace	urn:www.agenziaentrate.gov.it:specificheTecniche:sco:730
type	m730:Altre_Detrazioni_Type
children	m730:Codice m730:Importo

complexType **Dati_Altre_Detrazioni_Type**

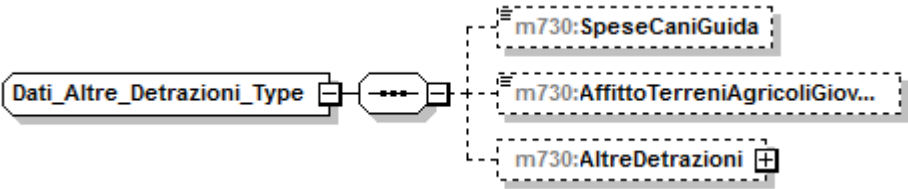
diagram	
namespace	urn:www.agenziaentrate.gov.it:specificheTecniche:sco:730
children	m730:SpeseCaniGuida m730:AffittoTerreniAgricoliGiovani m730:AltreDetrazioni

element **Dati_Altre_Detrazioni_Type/SpeseCaniGuida**

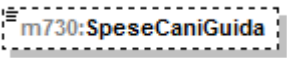
diagram					
namespace	urn:www.agenziaentrate.gov.it:specificheTecniche:sco:730				
type	DatoCB_Type				
facets	<table border="1"> <thead> <tr> <th>Kind</th> <th>Value</th> </tr> </thead> <tbody> <tr> <td>pattern</td> <td>[01]</td> </tr> </tbody> </table>	Kind	Value	pattern	[01]
Kind	Value				
pattern	[01]				

element **Dati_Altre_Detrazioni_Type/AffittoTerreniAgricoliGiovani**

diagram					
namespace	urn:www.agenziaentrate.gov.it:specificheTecniche:sco:730				
type	DatoNP_Type				
facets	<table border="1"> <tr> <td>Kind</td> <td>Value</td> </tr> <tr> <td>pattern</td> <td>[1-9]{1}[0-9]*</td> </tr> </table>	Kind	Value	pattern	[1-9]{1}[0-9]*
Kind	Value				
pattern	[1-9]{1}[0-9]*				

element **Dati_Altre_Detrazioni_Type/AltreDetrazioni**

diagram	
namespace	urn:www.agenziaentrate.gov.it:specificheTecniche:sco:730
type	m730:Altre_Detrazioni_Type
children	m730:Codice m730:Importo

complexType **Dati_Associazioni_Professionale_Type**

diagram	
namespace	urn:www.agenziaentrate.gov.it:specificheTecniche:sco:730
children	m730:CFAssociazione m730:DenominazioneAssociazione m730:CFProfessionista m730:CognomeProfessionista m730:NomeProfessionista

element **Dati_Associazioni_Professionale_Type/CFAssociazione**

diagram					
namespace	urn:www.agenziaentrate.gov.it:specificheTecniche:sco:730				
type	DatoCN_Type				
facets	<table border="1"> <tr> <td>Kind</td> <td>Value</td> </tr> <tr> <td>pattern</td> <td>[0-9]{11}</td> </tr> </table>	Kind	Value	pattern	[0-9]{11}
Kind	Value				
pattern	[0-9]{11}				

element **Dati_Associazioni_Professionale_Type/DenominazioneAssociazione**

diagram	
namespace	urn:www.agenziaentrate.gov.it:specificheTecniche:sco:730
type	DatoAN_Type
facets	Kind Value pattern ([0-9A-Z- "){1}([0-9A-Z&:] ' ~ \., / ^ \^\(\\)\) À È É Ì Ò Ù Ü "; \\ / +)*

element **Dati_Associazioni_Professionale_Type/CFProfessionista**

diagram	
namespace	urn:www.agenziaentrate.gov.it:specificheTecniche:sco:730
type	DatoCF_Type
facets	Kind Value pattern [0-9]{11}[A-Z]{6}[0-9LMNPQRSTUUV]{2}[A-Z]{1}[0-9LMNPQRSTUUV]{2}[A-Z]{1}[0-9LMNPQRSTUUV]{3}[A-Z]{1}

element **Dati_Associazioni_Professionale_Type/CognomeProfessionista**

diagram	
namespace	urn:www.agenziaentrate.gov.it:specificheTecniche:sco:730
type	DatoAN_Type
facets	Kind Value pattern ([0-9A-Z- "){1}([0-9A-Z&:] ' ~ \., / ^ \^\(\\)\) À È É Ì Ò Ù Ü "; \\ / +)*

element **Dati_Associazioni_Professionale_Type/NomeProfessionista**

diagram	
namespace	urn:www.agenziaentrate.gov.it:specificheTecniche:sco:730
type	DatoAN_Type
facets	Kind Value pattern ([0-9A-Z- "){1}([0-9A-Z&:] ' ~ \., / ^ \^\(\\)\) À È É Ì Ò Ù Ü "; \\ / +)*

complexType **Dati_CAF_Type**

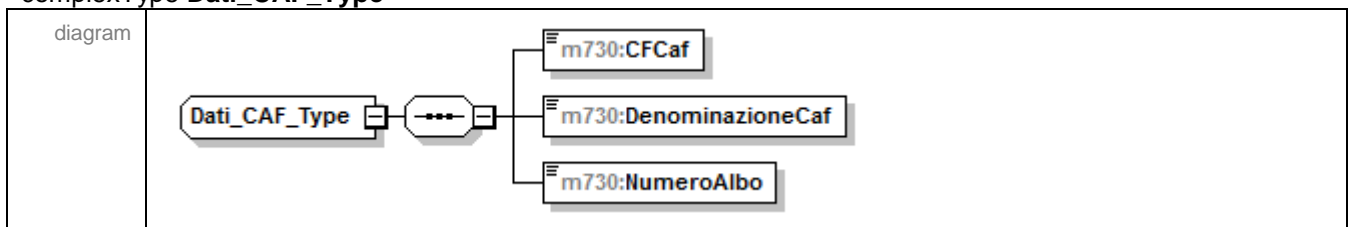

namespace	urn:www.agenziaentrate.gov.it:specificheTecniche:sco:730
children	m730:CFCaf m730:DenominazioneCaf m730:NumeroAlbo

element Dati_CAF_Type/CFCaf

diagram	
namespace	urn:www.agenziaentrate.gov.it:specificheTecniche:sco:730
type	DatoCN_Type
facets	Kind Value pattern [0-9]{11}

element Dati_CAF_Type/DenominazioneCaf

diagram	
namespace	urn:www.agenziaentrate.gov.it:specificheTecniche:sco:730
type	DatoAN_Type
facets	Kind Value pattern ([0-9A-Z\-\-]*)"){1}([0-9A-Z&:] ' \"- \". , / ^°\^\"(\\) À È É Ì Ò Ù Ú " \\ \\ +)*

element Dati_CAF_Type/NumeroAlbo

diagram	
namespace	urn:www.agenziaentrate.gov.it:specificheTecniche:sco:730
type	restriction of DatoNP_Type
facets	Kind Value pattern [1-9]{1}[0-9]*

complexType Dati_Catastali_Recupero_Patrimonio_Edilizio_Type

diagram	
namespace	urn:www.agenziaentrate.gov.it:specificheTecniche:sco:730
children	m730:NOrdImmobile m730:Condominio m730:DatiCatastali

element **Dati_Catastali_Recupero_Patrimonio_Edilizio_Type/NOrdImmobile**

diagram	
namespace	urn:www.agenziaentrate.gov.it:specificheTecniche:sco:730
type	DatoNP_Type
facets	Kind Value pattern [1-9]{1}[0-9]*

element **Dati_Catastali_Recupero_Patrimonio_Edilizio_Type/Condominio**

diagram	
namespace	urn:www.agenziaentrate.gov.it:specificheTecniche:sco:730
type	DatoCB_Type
facets	Kind Value pattern [01]

element **Dati_Catastali_Recupero_Patrimonio_Edilizio_Type/DatiCatastali**

diagram	
namespace	urn:www.agenziaentrate.gov.it:specificheTecniche:sco:730
type	m730:Dati_Catastali_Type
children	m730:CodiceComune m730:TerreniUrbano m730:SezioneUrbanaComuneCatastale m730:Foglio m730:Particella m730:Subalterno

complexType Dati_Catastali_Type

diagram	
namespace	urn:www.agenziaentrate.gov.it:specificheTecniche:sco:730
children	m730:CodiceComune m730:TerreniUrbano m730:SezioneUrbanaComuneCatastale m730:Foglio m730:Particella m730:Subalterno

element Dati_Catastali_Type/CodiceComune

diagram					
namespace	urn:www.agenziaentrate.gov.it:specificheTecniche:sco:730				
type	DatoAN_Type				
facets	<table border="1"> <tr> <td>Kind</td> <td>Value</td> </tr> <tr> <td>pattern</td> <td>(([0-9A-Z\-\]]&quot;){1}([0-9A-Z&amp;:] ' \- \., / ^ \^\(\\) À È É Ì Ò Ù Û &quot; \\ / +)*</td> </tr> </table>	Kind	Value	pattern	(([0-9A-Z\-\]]"){1}([0-9A-Z&:] ' \- \., / ^ \^\(\\) À È É Ì Ò Ù Û " \\ / +)*
Kind	Value				
pattern	(([0-9A-Z\-\]]"){1}([0-9A-Z&:] ' \- \., / ^ \^\(\\) À È É Ì Ò Ù Û " \\ / +)*				

element Dati_Catastali_Type/TerreniUrbano

diagram									
namespace	urn:www.agenziaentrate.gov.it:specificheTecniche:sco:730								
type	m730:Terreni Urbano_Type								
facets	<table border="1"> <tr> <td>Kind</td> <td>Value</td> </tr> <tr> <td>pattern</td> <td>(([0-9A-Z\-\]]&quot;){1}([0-9A-Z&amp;:] ' \- \., / ^ \^\(\\) À È É Ì Ò Ù Û &quot; \\ / +)*</td> </tr> <tr> <td>enumeration</td> <td>T</td> </tr> <tr> <td>enumeration</td> <td>U</td> </tr> </table>	Kind	Value	pattern	(([0-9A-Z\-\]]"){1}([0-9A-Z&:] ' \- \., / ^ \^\(\\) À È É Ì Ò Ù Û " \\ / +)*	enumeration	T	enumeration	U
Kind	Value								
pattern	(([0-9A-Z\-\]]"){1}([0-9A-Z&:] ' \- \., / ^ \^\(\\) À È É Ì Ò Ù Û " \\ / +)*								
enumeration	T								
enumeration	U								

element Dati_Catastali_Type/SezioneUrbanaComuneCatastale

diagram					
namespace	urn:www.agenziaentrate.gov.it:specificheTecniche:sco:730				
type	DatoAN_Type				
facets	<table border="1"> <tr> <td>Kind</td> <td>Value</td> </tr> <tr> <td>pattern</td> <td>(([0-9A-Z\-\]]&quot;){1}([0-9A-Z&amp;:] ' \- \., / ^ \^\(\\) À È É Ì Ò Ù Û &quot; \\ / +)*</td> </tr> </table>	Kind	Value	pattern	(([0-9A-Z\-\]]"){1}([0-9A-Z&:] ' \- \., / ^ \^\(\\) À È É Ì Ò Ù Û " \\ / +)*
Kind	Value				
pattern	(([0-9A-Z\-\]]"){1}([0-9A-Z&:] ' \- \., / ^ \^\(\\) À È É Ì Ò Ù Û " \\ / +)*				

element Dati_Catastali_Type/Foglio

diagram	
namespace	urn:www.agenziaentrate.gov.it:specificheTecniche:sco:730
type	DatoAN_Type
facets	Kind Value pattern ([0-9A-Z-] "){1}([0-9A-Z&] ' \"- \\. , / ^\\(\\) À È É Ì Ò Ù Û " \\ \\ \\+)*

element Dati_Catastali_Type/Particella

diagram	
namespace	urn:www.agenziaentrate.gov.it:specificheTecniche:sco:730
children	m730:Numeratore m730:Denominatore

element Dati_Catastali_Type/Particella/Numeratore

diagram	
namespace	urn:www.agenziaentrate.gov.it:specificheTecniche:sco:730
type	DatoAN_Type
facets	Kind Value pattern ([0-9A-Z-] "){1}([0-9A-Z&] ' \"- \\. , / ^\\(\\) À È É Ì Ò Ù Û " \\ \\ \\+)*

element Dati_Catastali_Type/Particella/Denominatore

diagram	
namespace	urn:www.agenziaentrate.gov.it:specificheTecniche:sco:730
type	DatoAN_Type
facets	Kind Value pattern ([0-9A-Z-] "){1}([0-9A-Z&] ' \"- \\. , / ^\\(\\) À È É Ì Ò Ù Û " \\ \\ \\+)*

element Dati_Catastali_Type/Subalterno

diagram	
namespace	urn:www.agenziaentrate.gov.it:specificheTecniche:sco:730
type	DatoAN_Type
facets	Kind Value pattern ([0-9A-Z-] "){1}([0-9A-Z&] ' \"- \\. , / ^\\(\\) À È É Ì Ò Ù Û " \\ \\ \\+)*

complexType Dati_Condominio_Type

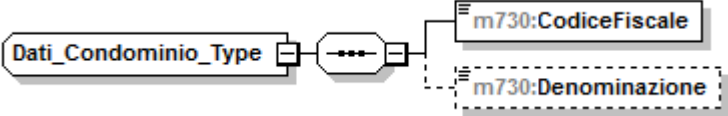
diagram	
namespace	urn:www.agenziaentrate.gov.it:specificheTecniche:sco:730
children	m730:CodiceFiscale m730:Denominazione

element Dati_Condominio_Type/CodiceFiscale

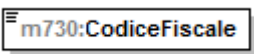
diagram					
namespace	urn:www.agenziaentrate.gov.it:specificheTecniche:sco:730				
type	DatoCF_Type				
facets	<table border="1"> <thead> <tr> <th>Kind</th> <th>Value</th> </tr> </thead> <tbody> <tr> <td>pattern</td> <td>[0-9]{11}[A-Z]{6}[0-9LMNPQRSTUVWXYZ]{2}[A-Z]{1}[0-9LMNPQRSTUVWXYZ]{2}[A-Z]{1}[0-9LMNPQRSTUVWXYZ]{3}[A-Z]{1}</td> </tr> </tbody> </table>	Kind	Value	pattern	[0-9]{11}[A-Z]{6}[0-9LMNPQRSTUVWXYZ]{2}[A-Z]{1}[0-9LMNPQRSTUVWXYZ]{2}[A-Z]{1}[0-9LMNPQRSTUVWXYZ]{3}[A-Z]{1}
Kind	Value				
pattern	[0-9]{11}[A-Z]{6}[0-9LMNPQRSTUVWXYZ]{2}[A-Z]{1}[0-9LMNPQRSTUVWXYZ]{2}[A-Z]{1}[0-9LMNPQRSTUVWXYZ]{3}[A-Z]{1}				

element Dati_Condominio_Type/Denominazione

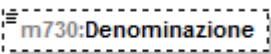
diagram					
namespace	urn:www.agenziaentrate.gov.it:specificheTecniche:sco:730				
type	DatoAN_Type				
facets	<table border="1"> <thead> <tr> <th>Kind</th> <th>Value</th> </tr> </thead> <tbody> <tr> <td>pattern</td> <td>(([0-9A-Z- &quot;]){1}([0-9A-Z&amp;:] ' - \., / ° ' \(\) À É È Ì Ò Ù Û &quot; \N \+)*</td> </tr> </tbody> </table>	Kind	Value	pattern	(([0-9A-Z- "]){1}([0-9A-Z&:] ' - \., / ° ' \(\) À É È Ì Ò Ù Û " \N \+)*
Kind	Value				
pattern	(([0-9A-Z- "]){1}([0-9A-Z&:] ' - \., / ° ' \(\) À É È Ì Ò Ù Û " \N \+)*				

complexType Dati_Coniuge_Type

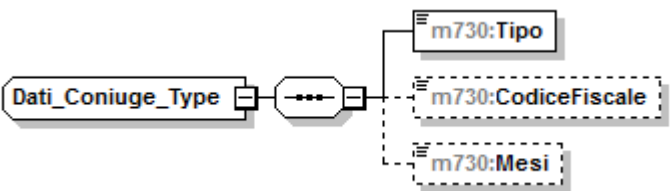
diagram	
namespace	urn:www.agenziaentrate.gov.it:specificheTecniche:sco:730
children	m730:Tipo m730:CodiceFiscale m730:Mesi

element Dati_Coniuge_Type/Tipo

diagram	
---------	---

namespace	urn:www.agenziaentrate.gov.it:specificheTecniche:sco:730				
type	DatoCB_Type				
facets	<table border="1"> <thead> <tr> <th>Kind</th> <th>Value</th> </tr> </thead> <tbody> <tr> <td>pattern</td> <td>[01]</td> </tr> </tbody> </table>	Kind	Value	pattern	[01]
Kind	Value				
pattern	[01]				

element Dati_Coniuge_Type/CodiceFiscale

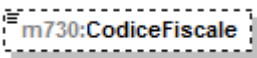
diagram					
namespace	urn:www.agenziaentrate.gov.it:specificheTecniche:sco:730				
type	DatoCF_Type				
facets	<table border="1"> <thead> <tr> <th>Kind</th> <th>Value</th> </tr> </thead> <tbody> <tr> <td>pattern</td> <td>[0-9]{11}[A-Z]{6}[0-9LMNPQRSTU]{2}[A-Z]{1}[0-9LMNPQRSTU]{2}[A-Z]{1}[0-9LMNPQRSTU]{3}[A-Z]{1}</td> </tr> </tbody> </table>	Kind	Value	pattern	[0-9]{11}[A-Z]{6}[0-9LMNPQRSTU]{2}[A-Z]{1}[0-9LMNPQRSTU]{2}[A-Z]{1}[0-9LMNPQRSTU]{3}[A-Z]{1}
Kind	Value				
pattern	[0-9]{11}[A-Z]{6}[0-9LMNPQRSTU]{2}[A-Z]{1}[0-9LMNPQRSTU]{2}[A-Z]{1}[0-9LMNPQRSTU]{3}[A-Z]{1}				

element Dati_Coniuge_Type/Mesi

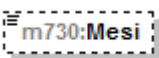
diagram																													
namespace	urn:www.agenziaentrate.gov.it:specificheTecniche:sco:730																												
type	m730:Mesi_Type																												
facets	<table border="1"> <thead> <tr> <th>Kind</th> <th>Value</th> </tr> </thead> <tbody> <tr> <td>pattern</td> <td>[1-9]{1}[0-9]*</td> </tr> <tr> <td>enumeration</td> <td>1</td> </tr> <tr> <td>enumeration</td> <td>2</td> </tr> <tr> <td>enumeration</td> <td>3</td> </tr> <tr> <td>enumeration</td> <td>4</td> </tr> <tr> <td>enumeration</td> <td>5</td> </tr> <tr> <td>enumeration</td> <td>6</td> </tr> <tr> <td>enumeration</td> <td>7</td> </tr> <tr> <td>enumeration</td> <td>8</td> </tr> <tr> <td>enumeration</td> <td>9</td> </tr> <tr> <td>enumeration</td> <td>10</td> </tr> <tr> <td>enumeration</td> <td>11</td> </tr> <tr> <td>enumeration</td> <td>12</td> </tr> </tbody> </table>	Kind	Value	pattern	[1-9]{1}[0-9]*	enumeration	1	enumeration	2	enumeration	3	enumeration	4	enumeration	5	enumeration	6	enumeration	7	enumeration	8	enumeration	9	enumeration	10	enumeration	11	enumeration	12
Kind	Value																												
pattern	[1-9]{1}[0-9]*																												
enumeration	1																												
enumeration	2																												
enumeration	3																												
enumeration	4																												
enumeration	5																												
enumeration	6																												
enumeration	7																												
enumeration	8																												
enumeration	9																												
enumeration	10																												
enumeration	11																												
enumeration	12																												

complexType **Dati_Contabili_Type**

diagram	
namespace	urn:www.agenziaentrate.gov.it:specificheTecniche:sco:730
children	m730:Familiari m730:QuadroA m730:QuadroB m730:QuadroC m730:QuadroD m730:QuadroE m730:QuadroF m730:QuadroG m730:QuadroI m730:ProspettoLiquidazione m730:Prospetto_Annotazioni m730:QuadroK

element **Dati_Contabili_Type/Familiari**

diagram	
namespace	urn:www.agenziaentrate.gov.it:specificheTecniche:sco:730
type	m730:Familiari_Type
children	m730:PrimoModulo m730:Modulo

element **Dati_Contabili_Type/QuadroA**

diagram	<p>The diagram shows a dashed box labeled 'm730:QuadroA' connected to a sequence connector (a circle with three dots). This connector is then connected to a box labeled 'm730:Modulo' with a cardinality of '1..∞' below it. The entire structure is enclosed in a larger dashed box labeled 'm730:Redditi_Terreni_Type'.</p>
namespace	urn:www.agenziaentrate.gov.it:specificheTecniche:sco:730
type	m730:Redditi_Terreni_Type
children	m730:Modulo

element **Dati_Contabili_Type/QuadroB**

diagram	<p>The diagram shows a dashed box labeled 'm730:QuadroB' connected to a sequence connector (a circle with three dots). This connector is then connected to a box labeled 'm730:Modulo' with a cardinality of '1..∞' below it. The entire structure is enclosed in a larger dashed box labeled 'm730:Redditi_Fabbricati_Type'.</p>
namespace	urn:www.agenziaentrate.gov.it:specificheTecniche:sco:730
type	m730:Redditi_Fabbricati_Type
children	m730:Modulo

element **Dati_Contabili_Type/QuadroC**

diagram	<p>The diagram shows a dashed box labeled 'm730:QuadroC' connected to a sequence connector (a circle with three dots). This connector branches into two paths: one leading to a box labeled 'm730:PrimoModulo' and another leading to a dashed box labeled 'm730:Modulo' with a cardinality of '0..∞' below it. The entire structure is enclosed in a larger dashed box labeled 'm730:Redditi_Lavoro_Dip_Type'.</p>
namespace	urn:www.agenziaentrate.gov.it:specificheTecniche:sco:730
type	m730:Redditi_Lavoro_Dip_Type
children	m730:PrimoModulo m730:Modulo

element **Dati_Contabili_Type/QuadroD**

diagram	<p>The diagram shows a dashed box labeled 'm730:QuadroD' connected to a sequence connector (a circle with three dots). This connector is then connected to a box labeled 'm730:Modulo' with a cardinality of '1..∞' below it. The entire structure is enclosed in a larger dashed box labeled 'm730:Altri_Redditi_Type (extension)'.</p>
---------	--

namespace	urn:www.agenziaentrate.gov.it:specificheTecniche:sco:730
type	extension of m730:Altri_Reddi_Type
children	m730:Modulo

element **Dati_Contabili_Type/QuadroE**

diagram	
namespace	urn:www.agenziaentrate.gov.it:specificheTecniche:sco:730
type	m730:Oneri_Type
children	m730:PrimoModulo m730:Modulo

element **Dati_Contabili_Type/QuadroF**

diagram	
namespace	urn:www.agenziaentrate.gov.it:specificheTecniche:sco:730
type	m730:Acconti_Ritenute_Type
children	m730:PrimoModulo m730:Modulo

element **Dati_Contabili_Type/QuadroG**

diagram	
namespace	urn:www.agenziaentrate.gov.it:specificheTecniche:sco:730
type	m730:Crediti_Imposta_Type

children	m730:PrimoModulo m730:Modulo
----------	--

element **Dati_Contabili_Type/Quadrol**

diagram	
namespace	urn:www.agenziaentrate.gov.it:specificheTecniche:sco:730
type	m730:Quadro_I_Type
children	m730:Importo m730:Casella

element **Dati_Contabili_Type/ProspettoLiquidazione**

diagram	
namespace	urn:www.agenziaentrate.gov.it:specificheTecniche:sco:730
type	m730:Prospetto_Liquidazione_Type
children	m730:PrimoModulo m730:Modulo

element **Dati_Contabili_Type/Prospetto_Annotazioni**

diagram	
namespace	urn:www.agenziaentrate.gov.it:specificheTecniche:sco:730
type	m730:Prospetto_Annotazioni_Type
children	m730:Modulo_Annotazioni

	enumeration	3A
	enumeration	3B
	enumeration	3P
	enumeration	3T

element Dati_Contratto_Type/NumeroContratto

diagram	
namespace	urn:www.agenziaentrate.gov.it:specificheTecniche:sco:730
type	DatoAN_Type
facets	Kind Value pattern ([0-9A-Z\-\] "){1}([0-9A-Z&] \- \., / ^\\(\\) À È É Ì Ò Ù Ü " \\ \\ +)*

element Dati_Contratto_Type/Sottonumero

diagram	
namespace	urn:www.agenziaentrate.gov.it:specificheTecniche:sco:730
type	DatoAN_Type
facets	Kind Value pattern ([0-9A-Z\-\] "){1}([0-9A-Z&] \- \., / ^\\(\\) À È É Ì Ò Ù Ü " \\ \\ +)*

element Dati_Contratto_Type/CodiceUfficio

diagram	
namespace	urn:www.agenziaentrate.gov.it:specificheTecniche:sco:730
type	restriction of DatoAN_Type
facets	Kind Value pattern ([0-9A-Z\-\] "){1}([0-9A-Z&] \- \., / ^\\(\\) À È É Ì Ò Ù Ü " \\ \\ +)*

complexType Dati_Familiare_Type

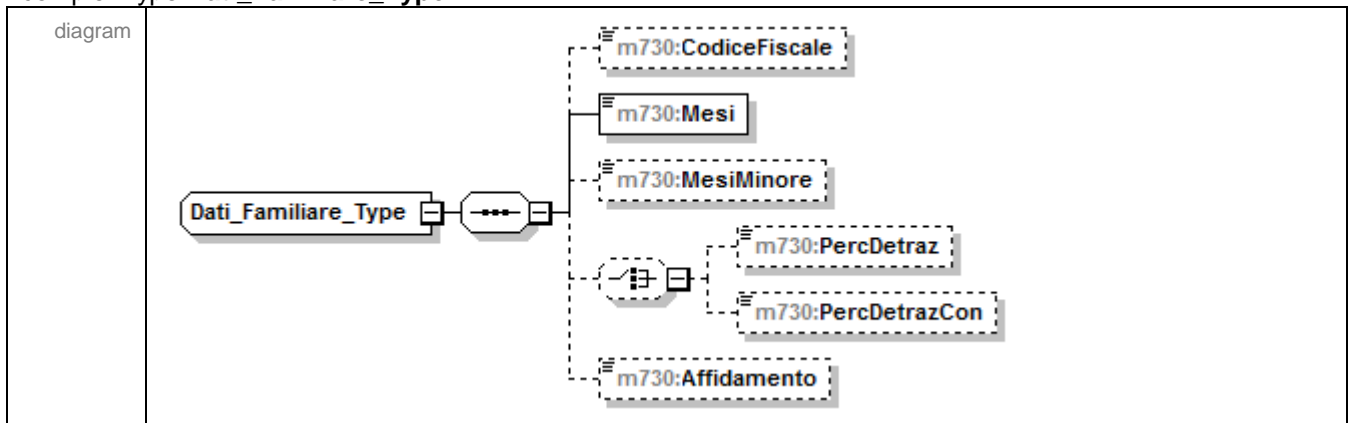

namespace	urn:www.agenziaentrate.gov.it:specificheTecniche:sco:730
children	m730:CodiceFiscale m730:Mesi m730:MesiMinore m730:PercDetraz m730:PercDetrazCon m730:Affidamento

element Dati_Familiare_Type/CodiceFiscale

diagram					
namespace	urn:www.agenziaentrate.gov.it:specificheTecniche:sco:730				
type	DatoCF_Type				
facets	<table border="1"> <thead> <tr> <th>Kind</th> <th>Value</th> </tr> </thead> <tbody> <tr> <td>pattern</td> <td>[0-9]{11}[A-Z]{6}[0-9LMNPQRSTUVWXYZ]{2}[A-Z]{1}[0-9LMNPQRSTUVWXYZ]{2}[A-Z]{1}[0-9LMNPQRSTUVWXYZ]{3}[A-Z]{1}</td> </tr> </tbody> </table>	Kind	Value	pattern	[0-9]{11}[A-Z]{6}[0-9LMNPQRSTUVWXYZ]{2}[A-Z]{1}[0-9LMNPQRSTUVWXYZ]{2}[A-Z]{1}[0-9LMNPQRSTUVWXYZ]{3}[A-Z]{1}
Kind	Value				
pattern	[0-9]{11}[A-Z]{6}[0-9LMNPQRSTUVWXYZ]{2}[A-Z]{1}[0-9LMNPQRSTUVWXYZ]{2}[A-Z]{1}[0-9LMNPQRSTUVWXYZ]{3}[A-Z]{1}				

element Dati_Familiare_Type/Mesi

diagram					
namespace	urn:www.agenziaentrate.gov.it:specificheTecniche:sco:730				
type	DatoNP_Type				
facets	<table border="1"> <thead> <tr> <th>Kind</th> <th>Value</th> </tr> </thead> <tbody> <tr> <td>pattern</td> <td>[1-9]{1}[0-9]*</td> </tr> </tbody> </table>	Kind	Value	pattern	[1-9]{1}[0-9]*
Kind	Value				
pattern	[1-9]{1}[0-9]*				

element Dati_Familiare_Type/MesiMinore

diagram					
namespace	urn:www.agenziaentrate.gov.it:specificheTecniche:sco:730				
type	DatoNP_Type				
facets	<table border="1"> <thead> <tr> <th>Kind</th> <th>Value</th> </tr> </thead> <tbody> <tr> <td>pattern</td> <td>[1-9]{1}[0-9]*</td> </tr> </tbody> </table>	Kind	Value	pattern	[1-9]{1}[0-9]*
Kind	Value				
pattern	[1-9]{1}[0-9]*				

element Dati_Familiare_Type/PercDetraz

diagram					
namespace	urn:www.agenziaentrate.gov.it:specificheTecniche:sco:730				
type	DatoPC_Type				
facets	<table border="1"> <thead> <tr> <th>Kind</th> <th>Value</th> </tr> </thead> <tbody> <tr> <td>pattern</td> <td>[0-9]?[0-9](, \d{1,3})? 100,(0{1,3})?</td> </tr> </tbody> </table>	Kind	Value	pattern	[0-9]?[0-9](, \d{1,3})? 100,(0{1,3})?
Kind	Value				
pattern	[0-9]?[0-9](, \d{1,3})? 100,(0{1,3})?				

element Dati_Familiare_Type/PercDetrazCon

diagram	
---------	--

namespace	urn:www.agenziaentrate.gov.it:specificheTecniche:sco:730
type	DatoAN_Type
facets	Kind Value pattern ([0-9A-Z\-\] \"){1}([0-9A-Z&#92; ' \- \., / ° °\(\) À É È Ì Ò Ù Ú " \ \\ \+)*

element Dati_Familiare_Type/Affidamento

diagram	
namespace	urn:www.agenziaentrate.gov.it:specificheTecniche:sco:730
type	DatoCB_Type
facets	Kind Value pattern [01]

complexType Dati_Fornitore_Type

diagram	
namespace	urn:www.agenziaentrate.gov.it:specificheTecniche:sco:730
children	m730:CodiceFiscale m730:CognomeDenom m730:Nome m730:Sesso m730:DataNascita m730:ComuneNascita m730:ProvinciaNascita m730:ImportoAcquisti

element Dati_Fornitore_Type/CodiceFiscale

diagram	
namespace	urn:www.agenziaentrate.gov.it:specificheTecniche:sco:730
type	DatoCF_Type
facets	Kind Value pattern [0-9]{11}[A-Z]{6}[0-9LMNPQRSTU]{2}[A-Z]{1}[0-9LMNPQRSTU]{2}[A-Z]{1}[0-9LMNPQRSTU]{3}[A-Z]{1}

facets	Kind Value pattern (([0-9A-Z\-\]]"){1}([0-9A-Z&]] ' \" . , / ° ^\(\\ \\) À É Ê Ï Ò Ù Ü " \\ \\ \\ +)*
--------	---

element **Dati_Fornitore_Type/ProvinciaNascita**

diagram	
namespace	urn:www.agenziaentrate.gov.it:specificheTecniche:sco:730
type	PN_Type

element **Dati_Fornitore_Type/ImportoAcquisti**

diagram	
namespace	urn:www.agenziaentrate.gov.it:specificheTecniche:sco:730
type	DatoNP_Type
facets	Kind Value pattern [1-9]{1}[0-9]*

complexType **Dati_Nascita_PF_Type**

diagram	
namespace	urn:www.agenziaentrate.gov.it:specificheTecniche:sco:730
children	m730:Sesso m730:DataNascita m730:ComuneNascita m730:ProvinciaNascita

element **Dati_Nascita_PF_Type/Sesso**

diagram	
namespace	urn:www.agenziaentrate.gov.it:specificheTecniche:sco:730
type	Sesso_Type
facets	Kind Value pattern (([0-9A-Z\-\]]"){1}([0-9A-Z&]] ' \" . , / ° ^\(\\ \\ \\) À É Ê Ï Ò Ù Ü " \\ \\ \\ +)* enumeration M enumeration F

element **Dati_Nascita_PF_Type/DataNascita**

diagram					
namespace	urn:www.agenziaentrate.gov.it:specificheTecniche:sco:730				
type	DatoDT_Type				
facets	<table border="1"> <thead> <tr> <th>Kind</th> <th>Value</th> </tr> </thead> <tbody> <tr> <td>pattern</td> <td>((([0-9]{12}[0-9]{3}[01])([0-9]{10}[12](\d{4})))([0-9]{12}[0-9]{30}([0-9]{11}(\d{4})))([0-9]{12}[0-9]{8})([0-9]{2}(\d{4})))([0-9]{2}([0-9]{2}[02468][048]00)))([0-9]{2}([0-9]{2}[13579][26]00)))([0-9]{2}([0-9]{2}[0-9][0-9][048])))([0-9]{2}([0-9][0-9][2468][048])))([0-9]{2}([0-9][0-9][13579][26]))))</td> </tr> </tbody> </table>	Kind	Value	pattern	((([0-9]{12}[0-9]{3}[01])([0-9]{10}[12](\d{4})))([0-9]{12}[0-9]{30}([0-9]{11}(\d{4})))([0-9]{12}[0-9]{8})([0-9]{2}(\d{4})))([0-9]{2}([0-9]{2}[02468][048]00)))([0-9]{2}([0-9]{2}[13579][26]00)))([0-9]{2}([0-9]{2}[0-9][0-9][048])))([0-9]{2}([0-9][0-9][2468][048])))([0-9]{2}([0-9][0-9][13579][26]))))
Kind	Value				
pattern	((([0-9]{12}[0-9]{3}[01])([0-9]{10}[12](\d{4})))([0-9]{12}[0-9]{30}([0-9]{11}(\d{4})))([0-9]{12}[0-9]{8})([0-9]{2}(\d{4})))([0-9]{2}([0-9]{2}[02468][048]00)))([0-9]{2}([0-9]{2}[13579][26]00)))([0-9]{2}([0-9]{2}[0-9][0-9][048])))([0-9]{2}([0-9][0-9][2468][048])))([0-9]{2}([0-9][0-9][13579][26]))))				

element **Dati_Nascita_PF_Type/ComuneNascita**

diagram					
namespace	urn:www.agenziaentrate.gov.it:specificheTecniche:sco:730				
type	DatoAN_Type				
facets	<table border="1"> <thead> <tr> <th>Kind</th> <th>Value</th> </tr> </thead> <tbody> <tr> <td>pattern</td> <td>([0-9A-Z-] \&quot;){1}([0-9A-Z&amp;:] [-\.,/ °\^\\(\)\À È É Ì Ò Ù Û \&quot; \ \\ /+)*</td> </tr> </tbody> </table>	Kind	Value	pattern	([0-9A-Z-] \"){1}([0-9A-Z&:] [-\.,/ °\^\\(\)\À È É Ì Ò Ù Û \" \ \\ /+)*
Kind	Value				
pattern	([0-9A-Z-] \"){1}([0-9A-Z&:] [-\.,/ °\^\\(\)\À È É Ì Ò Ù Û \" \ \\ /+)*				

element **Dati_Nascita_PF_Type/ProvinciaNascita**

diagram	
namespace	urn:www.agenziaentrate.gov.it:specificheTecniche:sco:730
type	PN_Type

complexType **Dati_Primo_Figlio_Type**

diagram	
namespace	urn:www.agenziaentrate.gov.it:specificheTecniche:sco:730
children	m730:Tipo m730:CodiceFiscale m730:Mesi m730:MesiMinore m730:PercDetraz m730:Affidamento

element Dati_Primo_Figlio_Type/Tipo

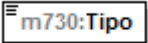
diagram									
namespace	urn:www.agenziaentrate.gov.it:specificheTecniche:sco:730								
type	restriction of DatoAN_Type								
facets	<table border="0"> <tr> <td>Kind</td> <td>Value</td> </tr> <tr> <td>pattern</td> <td>(([0-9A-Z\-\-])&quot;){1}([0-9A-Z&amp;]) '\-\. . / ° ¥\(\)\ À È É Ì Ò Ù Û &quot; \ \\ /+)*</td> </tr> <tr> <td>enumeration</td> <td>F</td> </tr> <tr> <td>enumeration</td> <td>D</td> </tr> </table>	Kind	Value	pattern	(([0-9A-Z\-\-])"){1}([0-9A-Z&]) '\-\. . / ° ¥\(\)\ À È É Ì Ò Ù Û " \ \\ /+)*	enumeration	F	enumeration	D
Kind	Value								
pattern	(([0-9A-Z\-\-])"){1}([0-9A-Z&]) '\-\. . / ° ¥\(\)\ À È É Ì Ò Ù Û " \ \\ /+)*								
enumeration	F								
enumeration	D								

element Dati_Primo_Figlio_Type/CodiceFiscale

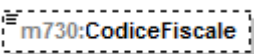
diagram					
namespace	urn:www.agenziaentrate.gov.it:specificheTecniche:sco:730				
type	DatoCF_Type				
facets	<table border="0"> <tr> <td>Kind</td> <td>Value</td> </tr> <tr> <td>pattern</td> <td>[0-9]{11}[A-Z]{6}[0-9LMNPQRSTU]{2}[A-Z]{1}[0-9LMNPQRSTU]{2}[A-Z]{1}[0-9LMNPQRSTU]{3}[A-Z]{1}</td> </tr> </table>	Kind	Value	pattern	[0-9]{11}[A-Z]{6}[0-9LMNPQRSTU]{2}[A-Z]{1}[0-9LMNPQRSTU]{2}[A-Z]{1}[0-9LMNPQRSTU]{3}[A-Z]{1}
Kind	Value				
pattern	[0-9]{11}[A-Z]{6}[0-9LMNPQRSTU]{2}[A-Z]{1}[0-9LMNPQRSTU]{2}[A-Z]{1}[0-9LMNPQRSTU]{3}[A-Z]{1}				

element Dati_Primo_Figlio_Type/Mesi

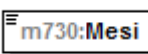
diagram																													
namespace	urn:www.agenziaentrate.gov.it:specificheTecniche:sco:730																												
type	m730:Mesi_Type																												
facets	<table border="0"> <tr> <td>Kind</td> <td>Value</td> </tr> <tr> <td>pattern</td> <td>[1-9]{1}[0-9]*</td> </tr> <tr> <td>enumeration</td> <td>1</td> </tr> <tr> <td>enumeration</td> <td>2</td> </tr> <tr> <td>enumeration</td> <td>3</td> </tr> <tr> <td>enumeration</td> <td>4</td> </tr> <tr> <td>enumeration</td> <td>5</td> </tr> <tr> <td>enumeration</td> <td>6</td> </tr> <tr> <td>enumeration</td> <td>7</td> </tr> <tr> <td>enumeration</td> <td>8</td> </tr> <tr> <td>enumeration</td> <td>9</td> </tr> <tr> <td>enumeration</td> <td>10</td> </tr> <tr> <td>enumeration</td> <td>11</td> </tr> <tr> <td>enumeration</td> <td>12</td> </tr> </table>	Kind	Value	pattern	[1-9]{1}[0-9]*	enumeration	1	enumeration	2	enumeration	3	enumeration	4	enumeration	5	enumeration	6	enumeration	7	enumeration	8	enumeration	9	enumeration	10	enumeration	11	enumeration	12
Kind	Value																												
pattern	[1-9]{1}[0-9]*																												
enumeration	1																												
enumeration	2																												
enumeration	3																												
enumeration	4																												
enumeration	5																												
enumeration	6																												
enumeration	7																												
enumeration	8																												
enumeration	9																												
enumeration	10																												
enumeration	11																												
enumeration	12																												

element Dati_Primo_Figlio_Type/MesiMinore

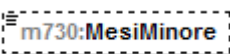
diagram									
namespace	urn:www.agenziaentrate.gov.it:specificheTecniche:sco:730								
type	m730:Mesi_Type								
facets	<table border="0"> <tr> <td>Kind</td> <td>Value</td> </tr> <tr> <td>pattern</td> <td>[1-9]{1}[0-9]*</td> </tr> <tr> <td>enumeration</td> <td>1</td> </tr> <tr> <td>enumeration</td> <td>2</td> </tr> </table>	Kind	Value	pattern	[1-9]{1}[0-9]*	enumeration	1	enumeration	2
Kind	Value								
pattern	[1-9]{1}[0-9]*								
enumeration	1								
enumeration	2								

enumeration	3
enumeration	4
enumeration	5
enumeration	6
enumeration	7
enumeration	8
enumeration	9
enumeration	10
enumeration	11
enumeration	12

element Dati_Primo_Figlio_Type/PercDetraz

diagram					
namespace	urn:www.agenziaentrate.gov.it:specificheTecniche:sco:730				
type	DatoPC_Type				
facets	<table border="1"> <tr><td>Kind</td><td>Value</td></tr> <tr><td>pattern</td><td>[0-9]?[0-9](,\d{1,3})? 100,0{1,3)?</td></tr> </table>	Kind	Value	pattern	[0-9]?[0-9](,\d{1,3})? 100,0{1,3)?
Kind	Value				
pattern	[0-9]?[0-9](,\d{1,3})? 100,0{1,3)?				

element Dati_Primo_Figlio_Type/Affidamento

diagram					
namespace	urn:www.agenziaentrate.gov.it:specificheTecniche:sco:730				
type	DatoCB_Type				
facets	<table border="1"> <tr><td>Kind</td><td>Value</td></tr> <tr><td>pattern</td><td>[01]</td></tr> </table>	Kind	Value	pattern	[01]
Kind	Value				
pattern	[01]				

complexType Dati_Professionista_Type

diagram	
namespace	urn:www.agenziaentrate.gov.it:specificheTecniche:sco:730
children	m730:CFProfessionista m730:CognomeProfessionista m730:NomeProfessionista

element Dati_Professionista_Type/CFProfessionista

diagram					
namespace	urn:www.agenziaentrate.gov.it:specificheTecniche:sco:730				
type	DatoCF_Type				
facets	<table border="1"> <tr><td>Kind</td><td>Value</td></tr> <tr><td>pattern</td><td>[0-9]{11}[A-Z]{6}[0-9LMNPQRSTUUV]{2}[A-Z]{1}[0-9LMNPQRSTUUV]{2}[A-Z]{1}[0-9LMNPQRSTUUV]{3}[A-Z]{1}</td></tr> </table>	Kind	Value	pattern	[0-9]{11}[A-Z]{6}[0-9LMNPQRSTUUV]{2}[A-Z]{1}[0-9LMNPQRSTUUV]{2}[A-Z]{1}[0-9LMNPQRSTUUV]{3}[A-Z]{1}
Kind	Value				
pattern	[0-9]{11}[A-Z]{6}[0-9LMNPQRSTUUV]{2}[A-Z]{1}[0-9LMNPQRSTUUV]{2}[A-Z]{1}[0-9LMNPQRSTUUV]{3}[A-Z]{1}				

element **Dati_Professionista_Type/CognomeProfessionista**

diagram	
namespace	urn:www.agenziaentrate.gov.it:specificheTecniche:sco:730
type	DatoAN_Type
facets	Kind Value pattern ([0-9A-Z-] \"){1}([0-9A-Z&#39;] ' \\- \\. , / ^\\^\(\\ \\) À È É Ì Ò Ù Û " \\ \\ \\ +)*

element **Dati_Professionista_Type/NomeProfessionista**

diagram	
namespace	urn:www.agenziaentrate.gov.it:specificheTecniche:sco:730
type	DatoAN_Type
facets	Kind Value pattern ([0-9A-Z-] \"){1}([0-9A-Z&#39;] ' \\- \\. , / ^\\^\(\\ \\) À È É Ì Ò Ù Û " \\ \\ \\ +)*

complexType **Dati_Registrazione_Accatastamento_Recupero_Patrimonio_Edilizio_Type**

diagram	
namespace	urn:www.agenziaentrate.gov.it:specificheTecniche:sco:730
children	m730:NOrdImmobile m730:Condominio m730:EstremiRegistrazioneContratto m730:DomandaAccatastamento

element **Dati_Registrazione_Accatastamento_Recupero_Patrimonio_Edilizio_Type/NOrdImmobile**

diagram	
namespace	urn:www.agenziaentrate.gov.it:specificheTecniche:sco:730
type	DatoNP_Type
facets	Kind Value pattern [1-9]{1}[0-9]*

element **Dati_Registrazione_Accatastamento_Recupero_Patrimonio_Edilizio_Type/Condominio**

diagram	
namespace	urn:www.agenziaentrate.gov.it:specificheTecniche:sco:730
type	DatoCB_Type
facets	Kind Value pattern [01]

element

Dati_Registrazione_Accatastamento_Recupero_Patrimonio_Edilizio_Type/EstremiRegistrazioneContratto

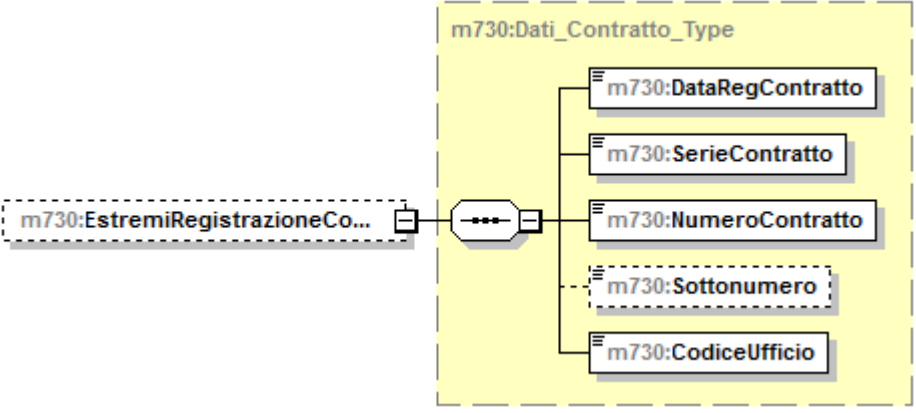
diagram	
namespace	urn:www.agenziaentrate.gov.it:specificheTecniche:sco:730
type	m730:Dati_Contratto_Type
children	m730:DataRegContratto m730:SerieContratto m730:NumeroContratto m730:Sottonumero m730:CodiceUfficio

element

Dati_Registrazione_Accatastamento_Recupero_Patrimonio_Edilizio_Type/DomandaAccatastamento

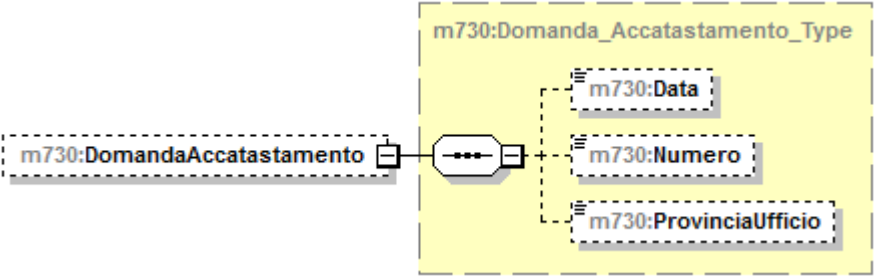
diagram	
namespace	urn:www.agenziaentrate.gov.it:specificheTecniche:sco:730
type	m730:Domanda_Accatastamento_Type
children	m730:Data m730:Numero m730:ProvinciaUfficio

complexType **Dati_Rettificati_Type**

diagram	
namespace	urn:www.agenziaentrate.gov.it:specificheTecniche:sco:730
children	m730:Rettifica

element **Dati_Rettificati_Type/Rettifica**

diagram	
namespace	urn:www.agenziaentrate.gov.it:specificheTecniche:sco:730
type	m730:Rettifica_Type
children	m730:Quadro m730:Rigo m730:Colonna m730:Modulo m730:DatoRimosso

complexType **Debito_Type**

diagram	
namespace	urn:www.agenziaentrate.gov.it:specificheTecniche:sco:730
children	m730:NonVersare m730:ImportoDaTrattenere

element **Debito_Type/NonVersare**

diagram					
namespace	urn:www.agenziaentrate.gov.it:specificheTecniche:sco:730				
type	DatoNP_Type				
facets	<table border="1"> <thead> <tr> <th>Kind</th> <th>Value</th> </tr> </thead> <tbody> <tr> <td>pattern</td> <td>[1-9]{1}[0-9]*</td> </tr> </tbody> </table>	Kind	Value	pattern	[1-9]{1}[0-9]*
Kind	Value				
pattern	[1-9]{1}[0-9]*				

element **Debito_Type/ImportoDaTrattenere**

diagram	
namespace	urn:www.agenziaentrate.gov.it:specificheTecniche:sco:730
type	DatoNP_Type
facets	Kind Value pattern [1-9]{1}[0-9]*

complexType **Deduzioni_Modulo_Type**

diagram	
namespace	urn:www.agenziaentrate.gov.it:specificheTecniche:sco:730
children	m730:AssegnoConiuge m730:AltriOneri m730:AcquistoCostruzioneAbitLocazione

element **Deduzioni_Modulo_Type/AssegnoConiuge**

diagram	
namespace	urn:www.agenziaentrate.gov.it:specificheTecniche:sco:730
type	m730:Assegno Coniuge_Type
children	m730:CodiceFiscale m730:Importo

element **Deduzioni_Modulo_Type/AltriOneri**

diagram	
namespace	urn:www.agenziaentrate.gov.it:specificheTecniche:sco:730
type	m730:Altri_Oneri_Type

children	m730:Codice m730:Importo
----------	--

element **Deduzioni_Modulo_Type/AcquistoCostruzioneAbitLocazione**

diagram	
namespace	urn:www.agenziaentrate.gov.it:specificheTecniche:sco:730
type	m730:Acquisto_Costruzione_Abit_Type
children	m730:DataStipula m730:Spesa m730:InteressiMutuo

complexType **Deduzioni_Type**

diagram	
namespace	urn:www.agenziaentrate.gov.it:specificheTecniche:sco:730
children	m730:ContributiPrevAss m730:AssegnoConiuge m730:ContributiColf m730:ErogazioniIstituzioniReligiose

	m730:SpesePortatoriHandicap m730:AltriOneri m730:DeducibilitaOrdinaria m730:LavoratoriPrimaOccupazione m730:FondInSquilibrioFinanziario m730:FamiliariACarico m730:FondoPensioneDipendentiPubblici m730:AcquistoCostruzioneAbitLocazione m730:RestituzioneSomme
--	---

element **Deduzioni_Type/ContributiPrevAss**

diagram	
namespace	urn:www.agenziaentrate.gov.it:specificheTecniche:sco:730
type	DatoNP_Type
facets	Kind Value pattern [1-9]{1}[0-9]*

element **Deduzioni_Type/AssegnoConiuge**

diagram	
namespace	urn:www.agenziaentrate.gov.it:specificheTecniche:sco:730
type	m730:Assegno_Coniuge_Type
children	m730:CodiceFiscale m730:Importo

element **Deduzioni_Type/ContributiColf**

diagram	
namespace	urn:www.agenziaentrate.gov.it:specificheTecniche:sco:730
type	DatoNP_Type
facets	Kind Value pattern [1-9]{1}[0-9]*

element **Deduzioni_Type/ErogazioniIstituzioniReligiose**

diagram	
namespace	urn:www.agenziaentrate.gov.it:specificheTecniche:sco:730
type	DatoNP_Type
facets	Kind Value pattern [1-9]{1}[0-9]*

element **Deduzioni_Type/SpesePortatoriHandicap**

diagram	
namespace	urn:www.agenziaentrate.gov.it:specificheTecniche:sco:730
type	DatoNP_Type
facets	Kind Value pattern [1-9]{1}[0-9]*

element **Deduzioni_Type/AltriOneri**

diagram	
namespace	urn:www.agenziaentrate.gov.it:specificheTecniche:sco:730
type	m730:Altri_Oneri_Type
children	m730:Codice m730:Importo

element **Deduzioni_Type/DeducibilitaOrdinaria**

diagram	
namespace	urn:www.agenziaentrate.gov.it:specificheTecniche:sco:730
type	m730:Contributi_Previdenza_Complementare_Type
children	m730:EsclusiDalSostituto m730:NonEsclusiDalSostituto

element **Deduzioni_Type/LavoratoriPrimaOccupazione**

diagram	
namespace	urn:www.agenziaentrate.gov.it:specificheTecniche:sco:730

type	m730:Contributi Previdenza Complementare Type
children	m730:EsclusiDalSostituto m730:NonEsclusiDalSostituto

element Deduzioni_Type/FondiInSquilibrioFinanziario

diagram	
namespace	urn:www.agenziaentrate.gov.it:specificheTecniche:sco:730
type	m730:Contributi Previdenza Complementare Type
children	m730:EsclusiDalSostituto m730:NonEsclusiDalSostituto

element Deduzioni_Type/FamiliariACarico

diagram	
namespace	urn:www.agenziaentrate.gov.it:specificheTecniche:sco:730
type	m730:Contributi Previdenza Complementare Type
children	m730:EsclusiDalSostituto m730:NonEsclusiDalSostituto

element Deduzioni_Type/FondoPensioneDipendentiPubblici

diagram	
namespace	urn:www.agenziaentrate.gov.it:specificheTecniche:sco:730
type	m730:Fondo Pensione Dipendenti Pubblici Type
children	m730:Contributi m730:QuotaTFR

element **Deduzioni_Type/AcquistoCostruzioneAbitLocazione**

diagram	
namespace	urn:www.agenziaentrate.gov.it:specificheTecniche:sco:730
type	m730:Acquisto Costruzione Abit Type
children	m730:DataStipula m730:Spesa m730:InteressiMutuo

element **Deduzioni_Type/RestituzioneSomme**

diagram	
namespace	urn:www.agenziaentrate.gov.it:specificheTecniche:sco:730
type	m730:Restituzione Somme Type
children	m730:SommeRestituite m730:ResiduoPrecedenteDic

complexType **Detrazione_Crediti_Type**

<p>diagram</p>	
<p>namespace</p>	<p>urn:www.agenziaentrate.gov.it:specificheTecniche:sco:730</p>
<p>children</p>	<p>m730:DetrazioneConiuge m730:DetrazioneFigli m730:UlterioreDetrazioneFigli m730:DetrazioneFamiliari m730:DetrazioneLavDip m730:DetrazionePens m730:DetrazioneAltriRedditi m730:DetrazioneOneri m730:DetrazioneRistrutturazione m730:DetrazioniArredolmmobili m730:DetrazioneRisparmioEnergetico m730:DetrazioneLocEAgricoliGiovani m730:AltreDetrazioni m730:CreditoPrimaCasa m730:CreditoOccupazione m730:CreditoFondiPensione m730:CreditoMediazioni m730:CreditoNegoziatione m730:TotaleDetrazioniCrediti</p>

element **Detrazione_Crediti_Type/DetrazioneConiuge**

diagram	
namespace	urn:www.agenziaentrate.gov.it:specificheTecniche:sco:730
type	DatoNP_Type
facets	Kind Value pattern [1-9]{1}[0-9]*

element **Detrazione_Crediti_Type/DetrazioneFigli**

diagram	
namespace	urn:www.agenziaentrate.gov.it:specificheTecniche:sco:730
type	DatoNP_Type
facets	Kind Value pattern [1-9]{1}[0-9]*

element **Detrazione_Crediti_Type/UlterioreDetrazioneFigli**

diagram	
namespace	urn:www.agenziaentrate.gov.it:specificheTecniche:sco:730
type	DatoNP_Type
facets	Kind Value pattern [1-9]{1}[0-9]*

element **Detrazione_Crediti_Type/DetrazioneFamiliari**

diagram	
namespace	urn:www.agenziaentrate.gov.it:specificheTecniche:sco:730
type	DatoNP_Type
facets	Kind Value pattern [1-9]{1}[0-9]*

element **Detrazione_Crediti_Type/DetrazioneLavDip**

diagram	
namespace	urn:www.agenziaentrate.gov.it:specificheTecniche:sco:730
type	DatoNP_Type
facets	Kind Value pattern [1-9]{1}[0-9]*

element **Detrazione_Crediti_Type/DetrazionePens**

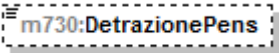
diagram	
namespace	urn:www.agenziaentrate.gov.it:specificheTecniche:sco:730
type	DatoNP_Type
facets	Kind Value pattern [1-9]{1}[0-9]*

element **Detrazione_Crediti_Type/DetrazioneAltriRedditi**

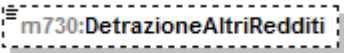
diagram	
namespace	urn:www.agenziaentrate.gov.it:specificheTecniche:sco:730
type	DatoNP_Type
facets	Kind Value pattern [1-9]{1}[0-9]*

element **Detrazione_Crediti_Type/DetrazioneOneri**

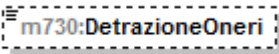
diagram	
namespace	urn:www.agenziaentrate.gov.it:specificheTecniche:sco:730
type	DatoNP_Type
facets	Kind Value pattern [1-9]{1}[0-9]*

element **Detrazione_Crediti_Type/DetrazioneRistrutturazione**

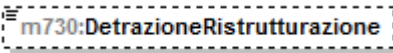
diagram	
namespace	urn:www.agenziaentrate.gov.it:specificheTecniche:sco:730
type	DatoNP_Type
facets	Kind Value pattern [1-9]{1}[0-9]*

element **Detrazione_Crediti_Type/DetrazioniArredolImmobili**

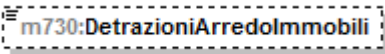
diagram	
namespace	urn:www.agenziaentrate.gov.it:specificheTecniche:sco:730
type	DatoNP_Type
facets	Kind Value pattern [1-9]{1}[0-9]*

element **Detrazione_Crediti_Type/DetrazioneRisparmioEnergetico**

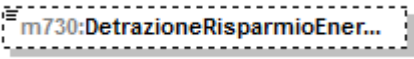
diagram					
namespace	urn:www.agenziaentrate.gov.it:specificheTecniche:sco:730				
type	DatoNP_Type				
facets	<table border="1"> <tr> <td>Kind</td> <td>Value</td> </tr> <tr> <td>pattern</td> <td>[1-9]{1}[0-9]*</td> </tr> </table>	Kind	Value	pattern	[1-9]{1}[0-9]*
Kind	Value				
pattern	[1-9]{1}[0-9]*				

element **Detrazione_Crediti_Type/DetrazioneLocEAgricoliGiovani**

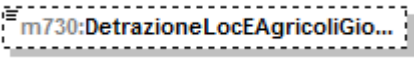
diagram					
namespace	urn:www.agenziaentrate.gov.it:specificheTecniche:sco:730				
type	DatoNP_Type				
facets	<table border="1"> <tr> <td>Kind</td> <td>Value</td> </tr> <tr> <td>pattern</td> <td>[1-9]{1}[0-9]*</td> </tr> </table>	Kind	Value	pattern	[1-9]{1}[0-9]*
Kind	Value				
pattern	[1-9]{1}[0-9]*				

element **Detrazione_Crediti_Type/AltreDetrazioni**

diagram					
namespace	urn:www.agenziaentrate.gov.it:specificheTecniche:sco:730				
type	DatoNP_Type				
facets	<table border="1"> <tr> <td>Kind</td> <td>Value</td> </tr> <tr> <td>pattern</td> <td>[1-9]{1}[0-9]*</td> </tr> </table>	Kind	Value	pattern	[1-9]{1}[0-9]*
Kind	Value				
pattern	[1-9]{1}[0-9]*				

element **Detrazione_Crediti_Type/CreditoPrimaCasa**

diagram					
namespace	urn:www.agenziaentrate.gov.it:specificheTecniche:sco:730				
type	DatoNP_Type				
facets	<table border="1"> <tr> <td>Kind</td> <td>Value</td> </tr> <tr> <td>pattern</td> <td>[1-9]{1}[0-9]*</td> </tr> </table>	Kind	Value	pattern	[1-9]{1}[0-9]*
Kind	Value				
pattern	[1-9]{1}[0-9]*				

element **Detrazione_Crediti_Type/CreditoOccupazione**

diagram	
namespace	urn:www.agenziaentrate.gov.it:specificheTecniche:sco:730
type	DatoNP_Type

facets	Kind	Value
	pattern	[1-9]{1}[0-9]*

element **Detrazione_Crediti_Type/CreditoFondiPensione**

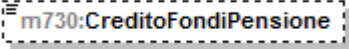
diagram	
namespace	urn:www.agenziaentrate.gov.it:specificheTecniche:sco:730
type	DatoNP_Type
facets	Kind Value pattern [1-9]{1}[0-9]*

element **Detrazione_Crediti_Type/CreditoMediazioni**

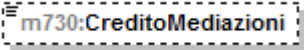
diagram	
namespace	urn:www.agenziaentrate.gov.it:specificheTecniche:sco:730
type	DatoNP_Type
facets	Kind Value pattern [1-9]{1}[0-9]*

element **Detrazione_Crediti_Type/CreditoNegoziazione**

diagram	
namespace	urn:www.agenziaentrate.gov.it:specificheTecniche:sco:730
type	DatoNP_Type
facets	Kind Value pattern [1-9]{1}[0-9]*

element **Detrazione_Crediti_Type/TotaleDetrazioniCrediti**

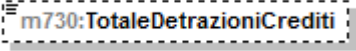
diagram	
namespace	urn:www.agenziaentrate.gov.it:specificheTecniche:sco:730
type	DatoNP_Type
facets	Kind Value pattern [1-9]{1}[0-9]*

complexType **Detrazioni_Canoni_Locazione_Type**

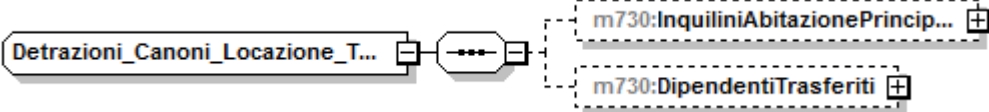
diagram	
---------	--

namespace	urn:www.agenziaentrate.gov.it:specificheTecniche:sco:730
children	m730:InquiliniAbitazionePrincipale m730:DipendentiTrasferiti

element **Detrazioni_Canoni_Locazione_Type/InquiliniAbitazionePrincipale**

diagram	
namespace	urn:www.agenziaentrate.gov.it:specificheTecniche:sco:730
type	m730:Inquilini_Abitazione_Principale_Type
children	m730:Tipologia m730:GiorniPercentuale

element **Detrazioni_Canoni_Locazione_Type/DipendentiTrasferiti**

diagram	
namespace	urn:www.agenziaentrate.gov.it:specificheTecniche:sco:730
type	m730:Giorni_Percentuale_Type
children	m730:Giorni m730:Percentuale

complexType **Detrazioni_Modulo_Type**

diagram	
namespace	urn:www.agenziaentrate.gov.it:specificheTecniche:sco:730
children	m730:VeicoliDisabili m730:AcquistoCaniGuida m730:SpeseRateizzate m730:AltreSpese

element **Detrazioni_Modulo_Type/VeicoliDisabili**

diagram	
namespace	urn:www.agenziaentrate.gov.it:specificheTecniche:sco:730
type	m730:Spese_Rateizzate_Type
children	m730:Codice m730:Importo

element **Detrazioni_Modulo_Type/AcquistoCaniGuida**

diagram	
namespace	urn:www.agenziaentrate.gov.it:specificheTecniche:sco:730
type	m730:Spese_Rateizzate_Type
children	m730:Codice m730:Importo

element **Detrazioni_Modulo_Type/SpeseRateizzate**

diagram	
namespace	urn:www.agenziaentrate.gov.it:specificheTecniche:sco:730
type	m730:Spese_Rateizzate_Anni_Precedenti_Type
children	m730:Codice m730:Importo

element **Detrazioni_Modulo_Type/AltreSpese**

diagram	
namespace	urn:www.agenziaentrate.gov.it:specificheTecniche:sco:730
type	m730:Altre_Spese_Type
children	m730:Codice m730:Importo

complexType **Detrazioni_Type**

diagram	
namespace	urn:www.agenziaentrate.gov.it:specificheTecniche:sco:730
children	m730:CasellaRateazione m730:SpeseDeterminatePatologie m730:SpeseSanitarie m730:SpeseFamNonACarico m730:SpeseSanitarieDisabili m730:VeicoliDisabili m730:AcquistoCaniGuida m730:SpeseRateizzate m730:MutuiAbPrincipale m730:AltreSpese

element **Detrazioni_Type/CasellaRateazione**

diagram	
namespace	urn:www.agenziaentrate.gov.it:specificheTecniche:sco:730
type	DatoCB_Type

facets	Kind pattern	Value [01]
--------	-----------------	---------------

element **Detrazioni_Type/SpeseDeterminatePatologie**

diagram	 m730:SpeseDeterminatePatologie	
namespace	urn:www.agenziaentrate.gov.it:specificheTecniche:sco:730	
type	DatoNP_Type	
facets	Kind pattern	Value [1-9]{1}[0-9]*

element **Detrazioni_Type/SpeseSanitarie**

diagram	 m730:Spese Sanitarie	
namespace	urn:www.agenziaentrate.gov.it:specificheTecniche:sco:730	
type	DatoNP_Type	
facets	Kind pattern	Value [1-9]{1}[0-9]*

element **Detrazioni_Type/SpeseFamNonACarico**

diagram	 m730:SpeseFamNonACarico	
namespace	urn:www.agenziaentrate.gov.it:specificheTecniche:sco:730	
type	DatoNP_Type	
facets	Kind pattern	Value [1-9]{1}[0-9]*

element **Detrazioni_Type/SpeseSanitarieDisabili**

diagram	 m730:Spese SanitarieDisabili	
namespace	urn:www.agenziaentrate.gov.it:specificheTecniche:sco:730	
type	DatoNP_Type	
facets	Kind pattern	Value [1-9]{1}[0-9]*

element **Detrazioni_Type/VeicoliDisabili**

diagram	<p>The diagram shows a dashed box labeled 'm730:VeicoliDisabili' connected to a central octagonal node. This node is connected to a larger dashed box labeled 'm730:Spese_Rateizzate_Type'. Inside this larger box, there are two smaller boxes: 'm730:Codice' and 'm730:Importo'.</p>
namespace	urn:www.agenziaentrate.gov.it:specificheTecniche:sco:730
type	m730:Spese_Rateizzate_Type
children	m730:Codice m730:Importo

element **Detrazioni_Type/AcquistoCaniGuida**

diagram	<p>The diagram shows a dashed box labeled 'm730:AcquistoCaniGuida' connected to a central octagonal node. This node is connected to a larger dashed box labeled 'm730:Spese_Rateizzate_Type'. Inside this larger box, there are two smaller boxes: 'm730:Codice' and 'm730:Importo'.</p>
namespace	urn:www.agenziaentrate.gov.it:specificheTecniche:sco:730
type	m730:Spese_Rateizzate_Type
children	m730:Codice m730:Importo

element **Detrazioni_Type/SpeseRateizzate**

diagram	<p>The diagram shows a dashed box labeled 'm730:SpeseRateizzate' connected to a central octagonal node. This node is connected to a larger dashed box labeled 'm730:Spese_Rateizzate_Anni_Precedenti_Type'. Inside this larger box, there are two smaller boxes: 'm730:Codice' and 'm730:Importo'.</p>
namespace	urn:www.agenziaentrate.gov.it:specificheTecniche:sco:730
type	m730:Spese_Rateizzate_Anni_Precedenti_Type
children	m730:Codice m730:Importo

element **Detrazioni_Type/MutuiAbPrincipale**

diagram	<p>The diagram shows a dashed box labeled 'm730:MutuiAbPrincipale'.</p>
namespace	urn:www.agenziaentrate.gov.it:specificheTecniche:sco:730
type	DatoNP_Type

facets	Kind pattern	Value [1-9]{1}[0-9]*
--------	-----------------	-------------------------

element **Detrazioni_Type/AltreSpese**

diagram	
namespace	urn:www.agenziaentrate.gov.it:specificheTecniche:sco:730
type	m730:Altre_Spese_Type
children	m730:Codice m730:Importo

complexType **Dichiarazione_Con_Type**

diagram	
namespace	urn:www.agenziaentrate.gov.it:specificheTecniche:sco:730
children	m730:Frontespizio m730:DatiContabili m730:FuoriAssistenzaQuadri m730:Scelte

element **Dichiarazione_Con_Type/Frontespizio**

<p>diagram</p>	
<p>namespace</p>	<p>urn:www.agenziaentrate.gov.it:specificheTecniche:sco:730</p>
<p>type</p>	<p>m730:Frontespizio Con Type</p>
<p>children</p>	<p>m730:SoggettoFiscale m730:DatiAnagrafici m730:StatoCivile m730:ResidenzaAnagrafica m730:DomicilioFiscale01012015 m730:DomicilioFiscale01012016 m730:CasiParticolariAddizionale m730:Firma</p>

element **Dichiarazione_Con_Type/DatiContabili**

<p>diagram</p>	
<p>namespace</p>	<p>urn:www.agenziaentrate.gov.it:specificheTecniche:sco:730</p>
<p>type</p>	<p>m730:Dati_Contabili_Type</p>
<p>children</p>	<p>m730:Familiari m730:QuadroA m730:QuadroB m730:QuadroC m730:QuadroD m730:QuadroE m730:QuadroF m730:QuadroG m730:QuadroI m730:ProspettoLiquidazione m730:Prospetto_Anotazioni m730:QuadroK</p>

element **Dichiarazione_Con_Type/FuoriAssistenzaQuadri**

diagram	
namespace	urn:www.agenziaentrate.gov.it:specificheTecniche:sco:730
type	m730:Fuori_Assistenza_Type
children	m730:AnomaliaDatianagrafici m730:AnomaliaTerreni m730:AnomaliaFabbricati m730:AnomaliaLavDip m730:AnomaliaAltriRedditi m730:AnomaliaQuadroF

element **Dichiarazione_Con_Type/Scelte**

diagram	
namespace	urn:www.agenziaentrate.gov.it:specificheTecniche:sco:730
type	sce:Scelte_Type
children	sce:Scelta5PerMille sce:Scelta8PerMille sce:Scelta2PerMille sce:Scelta2PerMilleAssCult

complexType Dichiarazione_Dich_Type

diagram	
namespace	urn:www.agenziaentrate.gov.it:specificheTecniche:sco:730
children	m730:Frontespizio m730:DatiContabili m730:FuoriAssistenza m730:Scelte

element Dichiarazione_Dich_Type/Frontespizio

diagram	
namespace	urn:www.agenziaentrate.gov.it:specificheTecniche:sco:730
type	extension of m730:Frontespizio Dich_Type
children	m730:SoggettoFiscale m730:DatiAnagrafici m730:StatoCivile m730:ResidenzaAnagrafica m730:DomicilioFiscale01012015 m730:DomicilioFiscale01012016 m730:CasiParticolariAddizionale m730:Firma m730:Rappresentante

element Dichiarazione_Dich_Type/DatiContabili

<p>diagram</p>	
<p>namespace</p>	<p>urn:www.agenziaentrate.gov.it:specificheTecniche:sco:730</p>
<p>type</p>	<p>m730:Dati_Contabili_Type</p>
<p>children</p>	<p>m730:Familiari m730:QuadroA m730:QuadroB m730:QuadroC m730:QuadroD m730:QuadroE m730:QuadroF m730:QuadroG m730:QuadroI m730:ProspettoLiquidazione m730:Prospetto_Annotazioni m730:QuadroK</p>

element Dichiarazione_Dich_Type/FuoriAssistenza

<p>diagram</p>	
<p>namespace</p>	<p>urn:www.agenziaentrate.gov.it:specificheTecniche:sco:730</p>
<p>children</p>	<p>m730:FuoriAssistenzaQuadri m730:AnomaliaDatiSostituto m730:AnomaliaDatiRappresentante</p>

element **Dichiarazione_Dich_Type/FuoriAssistenza/FuoriAssistenzaQuadri**

diagram	
namespace	urn:www.agenziaentrate.gov.it:specificheTecniche:sco:730
type	m730:Fuori_Assistenza_Type
children	m730:AnomaliaDatianagrafici m730:AnomaliaTerreni m730:AnomaliaFabbricati m730:AnomaliaLavDip m730:AnomaliaAltriRedditi m730:AnomaliaQuadroF

element **Dichiarazione_Dich_Type/FuoriAssistenza/AnomaliaDatiSostituto**

diagram					
namespace	urn:www.agenziaentrate.gov.it:specificheTecniche:sco:730				
type	DatoCB_Type				
facets	<table border="1"> <tr> <td>Kind</td> <td>Value</td> </tr> <tr> <td>pattern</td> <td>[01]</td> </tr> </table>	Kind	Value	pattern	[01]
Kind	Value				
pattern	[01]				

element **Dichiarazione_Dich_Type/FuoriAssistenza/AnomaliaDatiRappresentante**

diagram					
namespace	urn:www.agenziaentrate.gov.it:specificheTecniche:sco:730				
type	DatoCB_Type				
facets	<table border="1"> <tr> <td>Kind</td> <td>Value</td> </tr> <tr> <td>pattern</td> <td>[01]</td> </tr> </table>	Kind	Value	pattern	[01]
Kind	Value				
pattern	[01]				

element **Dichiarazione_Dich_Type/Scelte**

diagram	
namespace	urn:www.agenziaentrate.gov.it:specificheTecniche:sco:730
type	sce:Scelte_Type
children	sce:Scelta5PerMille sce:Scelta8PerMille sce:Scelta2PerMille sce:Scelta2PerMilleAssCult

complexType **Documento_730-4**

diagram	
namespace	urn:www.agenziaentrate.gov.it:specificheTecniche:sco:730
children	m730:DatiAnagraficiDichiarante m730:Sostituto m730:SoggettoAssFiscale730-4 m730:AltriDati m730:DatiContabili730-4

element Documento_730-4/DatiAnagraficiDichiarante

diagram	
namespace	urn:www.agenziaentrate.gov.it:specificheTecniche:sco:730
type	extension of Dati_Anagrafici_Type
children	Cognome Nome Sesso DataNascita ComuneNascita ProvinciaNascita m730:CFDichiarante

element Documento_730-4/DatiAnagraficiDichiarante/CFDichiarante

diagram					
namespace	urn:www.agenziaentrate.gov.it:specificheTecniche:sco:730				
type	DatoCF_Type				
facets	<table border="1"> <thead> <tr> <th>Kind</th> <th>Value</th> </tr> </thead> <tbody> <tr> <td>pattern</td> <td>[0-9]{11}[A-Z]{6}[0-9LMNPQRSTU]{2}[A-Z]{1}[0-9LMNPQRSTU]{2}[A-Z]{1}[0-9LMNPQRSTU]{3}[A-Z]{1}</td> </tr> </tbody> </table>	Kind	Value	pattern	[0-9]{11}[A-Z]{6}[0-9LMNPQRSTU]{2}[A-Z]{1}[0-9LMNPQRSTU]{2}[A-Z]{1}[0-9LMNPQRSTU]{3}[A-Z]{1}
Kind	Value				
pattern	[0-9]{11}[A-Z]{6}[0-9LMNPQRSTU]{2}[A-Z]{1}[0-9LMNPQRSTU]{2}[A-Z]{1}[0-9LMNPQRSTU]{3}[A-Z]{1}				

element **Documento_730-4/Sostituto**

<p>diagram</p>	
<p>namespace</p>	<p>urn:www.agenziaentrate.gov.it:specificheTecniche:sco:730</p>
<p>type</p>	<p>m730:Sostituto_Type</p>
<p>children</p>	<p>m730:CodiceFiscale m730:DatiAnagraficiPF m730:DenominazionePNF m730:Residenza m730:Fax m730:CodiceSede</p>

element **Documento_730-4/SoggettoAssFiscale730-4**

<p>diagram</p>	
<p>namespace</p>	<p>urn:www.agenziaentrate.gov.it:specificheTecniche:sco:730</p>
<p>children</p>	<p>m730:DatiCaf730-4 m730:DatiProfessionista730-4 m730:DatiAssociazione730-4 m730:DatiAgenzia730-4</p>

element **Documento_730-4/SoggettoAssFiscale730-4/DatiCaf730-4**

diagram	
namespace	urn:www.agenziaentrate.gov.it:specificheTecniche:sco:730
type	extension of m730:Dati_CAF_Type
children	m730:CFCaf m730:DenominazioneCaf m730:NumeroAlbo m730:DomicilioCaf m730:UfficioPerifericoCaf

element **Documento_730-4/SoggettoAssFiscale730-4/DatiCaf730-4/DomicilioCaf**

diagram	
namespace	urn:www.agenziaentrate.gov.it:specificheTecniche:sco:730
type	m730:Domicilio_Sogg_Ass_Fiscale_Type
children	m730:Comune m730:Provincia m730:CodiceComune m730:Cap m730:Indirizzo m730:Telefono m730:FAX m730:Email

element **Documento_730-4/SoggettoAssFiscale730-4/DatiCaf730-4/UfficioPerifericoCaf**

diagram	
namespace	urn:www.agenziaentrate.gov.it:specificheTecniche:sco:730
children	m730:DomicilioUffPeriferico

element **Documento_730-4/SoggettoAssFiscale730-4/DatiCaf730-4/UfficioPerifericoCaf/DomicilioUffPeriferico**

diagram	
namespace	urn:www.agenziaentrate.gov.it:specificheTecniche:sco:730
type	extension of m730:Domicilio Sogg Ass Fiscale Type
children	m730:Comune m730:Provincia m730:CodiceComune m730:Cap m730:Indirizzo m730:Telefono m730:FAX m730:Email m730:CodiceSedePeriferica

element **Documento_730-4/SoggettoAssFiscale730-4/DatiCaf730-4/UfficioPerifericoCaf/DomicilioUffPeriferico/CodiceSedePeriferica**

diagram					
namespace	urn:www.agenziaentrate.gov.it:specificheTecniche:sco:730				
type	DatoAN_Type				
facets	<table border="1"> <tr> <td>Kind</td> <td>Value</td> </tr> <tr> <td>pattern</td> <td>([0-9A-Z\-\-]{1}){1}([0-9A-Z&amp;#39; ! @ _ . \: / ° °\(\))À É È Ì Ò Ù Û &quot; \N\ +)*</td> </tr> </table>	Kind	Value	pattern	([0-9A-Z\-\-]{1}){1}([0-9A-Z&#39; ! @ _ . \: / ° °\(\))À É È Ì Ò Ù Û " \N\ +)*
Kind	Value				
pattern	([0-9A-Z\-\-]{1}){1}([0-9A-Z&#39; ! @ _ . \: / ° °\(\))À É È Ì Ò Ù Û " \N\ +)*				

element **Documento_730-4/SoggettoAssFiscale730-4/DatiProfessionista730-4**

diagram	<p>The diagram shows a class <code>m730:DatiProfessionista730-4</code> extending the base class <code>m730:Dati_Professionista_Type (extension)</code>. The extension includes four child elements: <code>m730:CFProfessionista</code>, <code>m730:CognomeProfessionista</code>, <code>m730:NomeProfessionista</code>, and <code>m730:DomicilioProf</code>.</p>
namespace	urn:www.agenziaentrate.gov.it:specificheTecniche:sco:730
type	extension of m730:Dati Professionista Type
children	m730:CFProfessionista m730:CognomeProfessionista m730:NomeProfessionista m730:DomicilioProf

element **Documento_730-4/SoggettoAssFiscale730-4/DatiProfessionista730-4/DomicilioProf**

diagram	<p>The diagram shows a class <code>m730:DomicilioProf</code> extending the base class <code>m730:Domicilio_Sogg_Ass_Fiscale_Type</code>. The extension includes eight child elements: <code>m730:Comune</code>, <code>m730:Provincia</code>, <code>m730:CodiceComune</code>, <code>m730:Cap</code>, <code>m730:Indirizzo</code>, <code>m730:Telefono</code>, <code>m730:FAX</code>, and <code>m730:Email</code>.</p>
namespace	urn:www.agenziaentrate.gov.it:specificheTecniche:sco:730
type	m730:Domicilio Sogg Ass Fiscale Type
children	m730:Comune m730:Provincia m730:CodiceComune m730:Cap m730:Indirizzo m730:Telefono m730:FAX m730:Email

element Documento_730-4/SoggettoAssFiscale730-4/DatiAssociazione730-4

diagram	<p>The diagram shows a class <code>m730:DatiAssociazione730-4</code> extending the class <code>m730:Dati_Associazioni_Professionale_Type</code>. The extension is highlighted in a yellow dashed box and includes the following elements: <code>m730:CFAssociazione</code>, <code>m730:DenominazioneAssociazione</code>, <code>m730:CFProfessionista</code>, <code>m730:CognomeProfessionista</code>, <code>m730:NomeProfessionista</code>, and <code>m730:DomicilioAssociazione</code>.</p>
namespace	urn:www.agenziaentrate.gov.it:specificheTecniche:sco:730
type	extension of m730:Dati_Associazioni_Professionale_Type
children	m730:CFAssociazione m730:DenominazioneAssociazione m730:CFProfessionista m730:CognomeProfessionista m730:NomeProfessionista m730:DomicilioAssociazione

element Documento_730-4/SoggettoAssFiscale730-4/DatiAssociazione730-4/DomicilioAssociazione

diagram	<p>The diagram shows a class <code>m730:DomicilioAssociazione</code> extending the class <code>m730:Domicilio_Sogg_Ass_Fiscale_Type</code>. The extension is highlighted in a yellow dashed box and includes the following elements: <code>m730:Comune</code>, <code>m730:Provincia</code>, <code>m730:CodiceComune</code>, <code>m730:Cap</code>, <code>m730:Indirizzo</code>, <code>m730:Telefono</code>, <code>m730:FAX</code>, and <code>m730:Email</code>.</p>
namespace	urn:www.agenziaentrate.gov.it:specificheTecniche:sco:730
type	m730:Domicilio_Sogg_Ass_Fiscale_Type
children	m730:Comune m730:Provincia m730:CodiceComune m730:Cap m730:Indirizzo m730:Telefono m730:FAX m730:Email

element Documento_730-4/SoggettoAssFiscale730-4/DatiAgenzia730-4

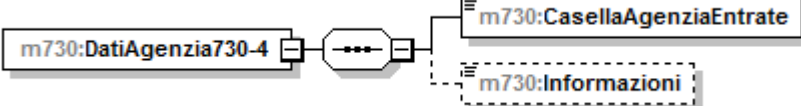
diagram	
namespace	urn:www.agenziaentrate.gov.it:specificheTecniche:sco:730
children	m730:CasellaAgenziaEntrate m730:Informazioni

element Documento_730-4/SoggettoAssFiscale730-4/DatiAgenzia730-4/CasellaAgenziaEntrate

diagram	
namespace	urn:www.agenziaentrate.gov.it:specificheTecniche:sco:730
type	DatoCB_Type
facets	Kind Value pattern [01]

element Documento_730-4/SoggettoAssFiscale730-4/DatiAgenzia730-4/Informazioni

diagram	
namespace	urn:www.agenziaentrate.gov.it:specificheTecniche:sco:730
type	DatoAN_Type
facets	Kind Value pattern ([0-9A-Z- "}{1}{[0-9A-Z&:] ' - \., / ° '^\(\\ \\) À È É Ì Ò Ù Û " \\ \\ +)*

element Documento_730-4/AltriDati

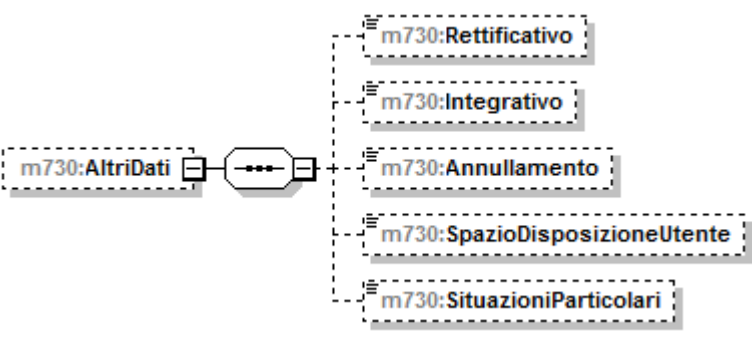
diagram	
namespace	urn:www.agenziaentrate.gov.it:specificheTecniche:sco:730
children	m730:Rettificativo m730:Integrativo m730:Annullamento m730:SpazioDisposizioneUtente m730:SituazioniParticolari

element **Documento_730-4/AltriDati/Rettificativo**

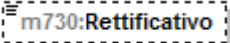
diagram											
namespace	urn:www.agenziaentrate.gov.it:specificheTecniche:sco:730										
type	m730:Rettificativo_Type										
facets	<table border="1"> <thead> <tr> <th>Kind</th> <th>Value</th> </tr> </thead> <tbody> <tr> <td>pattern</td> <td>[1-9]</td> </tr> <tr> <td>enumeration</td> <td>1</td> </tr> <tr> <td>enumeration</td> <td>2</td> </tr> <tr> <td>enumeration</td> <td>3</td> </tr> </tbody> </table>	Kind	Value	pattern	[1-9]	enumeration	1	enumeration	2	enumeration	3
Kind	Value										
pattern	[1-9]										
enumeration	1										
enumeration	2										
enumeration	3										

element **Documento_730-4/AltriDati/Integrativo**

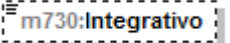
diagram											
namespace	urn:www.agenziaentrate.gov.it:specificheTecniche:sco:730										
type	m730:Integrativo_Type										
facets	<table border="1"> <thead> <tr> <th>Kind</th> <th>Value</th> </tr> </thead> <tbody> <tr> <td>pattern</td> <td>[1-9]</td> </tr> <tr> <td>enumeration</td> <td>1</td> </tr> <tr> <td>enumeration</td> <td>2</td> </tr> <tr> <td>enumeration</td> <td>3</td> </tr> </tbody> </table>	Kind	Value	pattern	[1-9]	enumeration	1	enumeration	2	enumeration	3
Kind	Value										
pattern	[1-9]										
enumeration	1										
enumeration	2										
enumeration	3										

element **Documento_730-4/AltriDati/Annullamento**

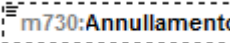
diagram					
namespace	urn:www.agenziaentrate.gov.it:specificheTecniche:sco:730				
type	DatoCB_Type				
facets	<table border="1"> <thead> <tr> <th>Kind</th> <th>Value</th> </tr> </thead> <tbody> <tr> <td>pattern</td> <td>[01]</td> </tr> </tbody> </table>	Kind	Value	pattern	[01]
Kind	Value				
pattern	[01]				

element **Documento_730-4/AltriDati/SpazioDisposizioneUtente**

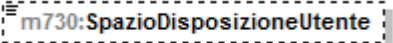
diagram					
namespace	urn:www.agenziaentrate.gov.it:specificheTecniche:sco:730				
type	DatoAN_Type				
facets	<table border="1"> <thead> <tr> <th>Kind</th> <th>Value</th> </tr> </thead> <tbody> <tr> <td>pattern</td> <td>(([0-9A-Z-] \&quot;){1}([0-9A-Z&amp;] " \- \., / "^\(\ \)\ À É É Ì Ò Ù Û &quot; \N \+)*</td> </tr> </tbody> </table>	Kind	Value	pattern	(([0-9A-Z-] \"){1}([0-9A-Z&] " \- \., / "^\(\ \)\ À É É Ì Ò Ù Û " \N \+)*
Kind	Value				
pattern	(([0-9A-Z-] \"){1}([0-9A-Z&] " \- \., / "^\(\ \)\ À É É Ì Ò Ù Û " \N \+)*				

element **Documento_730-4/AltriDati/SituazioniParticolari**

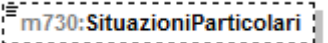
diagram	
namespace	urn:www.agenziaentrate.gov.it:specificheTecniche:sco:730

type	DatoNP_Type
facets	Kind Value pattern [1-9]{1}[0-9]*

element **Documento_730-4/DatiContabili730-4**

diagram	
namespace	urn:www.agenziaentrate.gov.it:specificheTecniche:sco:730
children	m730:Ordinario_730-4 m730:Integrativo_730-4

element **Documento_730-4/DatiContabili730-4/Ordinario_730-4**

diagram	
namespace	urn:www.agenziaentrate.gov.it:specificheTecniche:sco:730
children	m730:ImportiTrattenere m730:ImportiRimborsare m730:Conguaglio

element Documento_730-4/DatiContabili730-4/Ordinario_730-4/ImportiTrattenere

<p>diagram</p>	
<p>namespace</p>	<p>urn:www.agenziaentrate.gov.it:specificheTecniche:sco:730</p>
<p>type</p>	<p>m730:Importi Trattenere 730-4 Type</p>
<p>children</p>	<p>m730:IrpefTrattenere m730:AddRegTrattenere m730:AddComTrattenere m730:IrpefPrimaRataTrattenere m730:IrpefSecondaRataTrattenere m730:TassSepAccontoTrattenere m730:AddComAccontoTrattenere m730:CedolareTrattenere m730:CedolarePrimaRataTrattenere m730:CedolareSecondaRataTrattenere m730:ContribSolidTrattenere</p>

element Documento_730-4/DatiContabili730-4/Ordinario_730-4/ImportiRimborsare

<p>diagram</p>	
<p>namespace</p>	<p>urn:www.agenziaentrate.gov.it:specificheTecniche:sco:730</p>
<p>type</p>	<p>m730:Importi Rimborsare 730-4 Type</p>

children	m730:IrpefRimborsare m730:AddRegRimborsare m730:AddComRimborsare m730:CedolareRimborsare
----------	--

element **Documento_730-4/DatiContabili730-4/Ordinario_730-4/Conguaglio**

diagram	
namespace	urn:www.agenziaentrate.gov.it:specificheTecniche:sco:730
children	m730:NumeroRate m730:ImportoRimborsare m730:ImportoTrattenere

element **Documento_730-4/DatiContabili730-4/Ordinario_730-4/Conguaglio/NumeroRate**

diagram					
namespace	urn:www.agenziaentrate.gov.it:specificheTecniche:sco:730				
type	DatoN1_Type				
facets	<table border="1"> <thead> <tr> <th>Kind</th> <th>Value</th> </tr> </thead> <tbody> <tr> <td>pattern</td> <td>[1-9]</td> </tr> </tbody> </table>	Kind	Value	pattern	[1-9]
Kind	Value				
pattern	[1-9]				

element **Documento_730-4/DatiContabili730-4/Ordinario_730-4/Conguaglio/ImportoRimborsare**

diagram					
namespace	urn:www.agenziaentrate.gov.it:specificheTecniche:sco:730				
type	DatoNP_Type				
facets	<table border="1"> <thead> <tr> <th>Kind</th> <th>Value</th> </tr> </thead> <tbody> <tr> <td>pattern</td> <td>[1-9]{1}[0-9]*</td> </tr> </tbody> </table>	Kind	Value	pattern	[1-9]{1}[0-9]*
Kind	Value				
pattern	[1-9]{1}[0-9]*				

element **Documento_730-4/DatiContabili730-4/Ordinario_730-4/Conguaglio/ImportoTrattenere**

diagram					
namespace	urn:www.agenziaentrate.gov.it:specificheTecniche:sco:730				
type	DatoNP_Type				
facets	<table border="1"> <thead> <tr> <th>Kind</th> <th>Value</th> </tr> </thead> <tbody> <tr> <td>pattern</td> <td>[1-9]{1}[0-9]*</td> </tr> </tbody> </table>	Kind	Value	pattern	[1-9]{1}[0-9]*
Kind	Value				
pattern	[1-9]{1}[0-9]*				

element **Documento_730-4/DatiContabili730-4/Integrativo_730-4**

diagram	
---------	--

namespace	urn:www.agenziaentrate.gov.it:specificheTecniche:sco:730
children	m730:ImportiRimborsare

element Documento_730-4/DatiContabili730-4/Integrativo_730-4/ImportiRimborsare

diagram	<p>The diagram illustrates the structure of the <code>m730:ImportiRimborsare</code> element. It is represented as a container (rectangle) that contains a sequence of six child elements, each shown in a dashed-line box with a plus sign indicating it is optional. The child elements are: <code>m730:IrpefRimborsare</code>, <code>m730:AddRegRimborsare</code>, <code>m730:AddComRimborsare</code>, <code>m730:CedolareRimborsare</code>, <code>m730:TassazioneSepRimborsare</code>, and <code>m730:ContributoSolidarieta</code>. The entire container and its children are enclosed in a yellow dashed-line box labeled <code>m730:Importi_Rimborsare_730-4_Integrativo_Type</code>.</p>
namespace	urn:www.agenziaentrate.gov.it:specificheTecniche:sco:730
type	m730:Importi_Rimborsare_730-4_Integrativo_Type
children	m730:IrpefRimborsare m730:AddRegRimborsare m730:AddComRimborsare m730:CedolareRimborsare m730:TassazioneSepRimborsare m730:ContributoSolidarieta

complexType Documento_730_Type

diagram					
namespace	urn:www.agenziaentrate.gov.it:specificheTecniche:sco:730				
type	extension of Documento_Type				
children	m730:DichiarazioneDich m730:DichiarazioneCon m730:AltriDati m730:Sostituto m730:Mod730DipendentiSenzaSostituto m730:SoggettoAssFiscaleDoc m730:Documento_730-4 m730:EsitiContabili m730:DatiRettificati				
attributes	Name	Type	Use	Default	Fixed
	identificativo	Identificativo_Type	required		

element Documento_730_Type/DichiarazioneDich

diagram					
namespace	urn:www.agenziaentrate.gov.it:specificheTecniche:sco:730				

type	m730:Dichiarazione Dich Type
children	m730:Frontespizio m730:DatiContabili m730:FuoriAssistenza m730:Scelte

element **Documento_730_Type/DichiarazioneCon**

diagram	
namespace	urn:www.agenziaentrate.gov.it:specificheTecniche:sco:730
type	m730:Dichiarazione Con Type
children	m730:Frontespizio m730:DatiContabili m730:FuoriAssistenzaQuadri m730:Scelte

element **Documento_730_Type/AltriDati**

diagram	
namespace	urn:www.agenziaentrate.gov.it:specificheTecniche:sco:730

children	m730:FlagConferma m730:FlagAssenzaDati730-4 m730:FlagCfErratoDicTrasmessa m730:Rettificativo m730:Integrativo m730:CfProduttoreSoftware m730:SpazioDisposizioneUtente m730:DichiarazioneCongiunta m730:SituazioniParticolari m730:Mod730SenzaSostituto m730:ComunicazioneDatiRettificati m730:SostCafProfessNonDelegato
----------	---

element **Documento_730_Type/AltriDati/FlagConferma**

diagram	
namespace	urn:www.agenziaentrate.gov.it:specificheTecniche:sco:730
type	DatoCB_Type
facets	Kind Value pattern [01]

element **Documento_730_Type/AltriDati/FlagAssenzaDati730-4**

diagram	
namespace	urn:www.agenziaentrate.gov.it:specificheTecniche:sco:730
type	DatoCB_Type
facets	Kind Value pattern [01]

element **Documento_730_Type/AltriDati/FlagCfErratoDicTrasmessa**

diagram	
namespace	urn:www.agenziaentrate.gov.it:specificheTecniche:sco:730
type	DatoCF_Type
facets	Kind Value pattern [0-9]{11}[A-Z]{6}[0-9LMNPQRSTUUV]{2}[A-Z]{1}[0-9LMNPQRSTUUV]{2}[A-Z]{1}[0-9LMNPQRSTUUV]{3}[A-Z]{1}

element **Documento_730_Type/AltriDati/Rettificativo**

diagram	
namespace	urn:www.agenziaentrate.gov.it:specificheTecniche:sco:730
type	m730:Rettificativo_Type
facets	Kind Value pattern [1-9] enumeration 1 enumeration 2 enumeration 3

facets	Kind	Value
	pattern	[1-9]{1}[0-9]*

element **Documento_730_Type/AltriDati/Mod730SenzaSostituto**

diagram		
namespace	urn:www.agenziaentrate.gov.it:specificheTecniche:sco:730	
type	restriction of DatoAN_Type	
facets	Kind	Value
	pattern	(([0-9A-Z\-\-] \"){1}([0-9A-Z&] '\- \., / \° \^ \(\) \À \È \É \ \Ò \Ù \Ü \" \ \\ \ +)*
	enumeration	A

element **Documento_730_Type/AltriDati/ComunicazioneDatiRettificati**

diagram		
namespace	urn:www.agenziaentrate.gov.it:specificheTecniche:sco:730	
type	DatoCB_Type	
facets	Kind	Value
	pattern	[01]

element **Documento_730_Type/AltriDati/SostCafProfessNonDelegato**

diagram		
namespace	urn:www.agenziaentrate.gov.it:specificheTecniche:sco:730	
type	DatoCB_Type	
facets	Kind	Value
	pattern	[01]

element **Documento_730_Type/Sostituto**

diagram	
namespace	urn:www.agenziaentrate.gov.it:specificheTecniche:sco:730
type	m730:Sostituto_Type
children	m730:CodiceFiscale m730:DatiAnagraficiPF m730:DenominazionePNF m730:Residenza m730:Fax m730:CodiceSede

element **Documento_730_Type/Mod730DipendentiSenzaSostituto**

diagram					
namespace	urn:www.agenziaentrate.gov.it:specificheTecniche:sco:730				
type	DatoCB_Type				
facets	<table border="1"> <thead> <tr> <th>Kind</th> <th>Value</th> </tr> </thead> <tbody> <tr> <td>pattern</td> <td>[01]</td> </tr> </tbody> </table>	Kind	Value	pattern	[01]
Kind	Value				
pattern	[01]				

element **Documento_730_Type/SoggettoAssFiscaleDoc**

diagram	
namespace	urn:www.agenziaentrate.gov.it:specificheTecniche:sco:730
type	m730:Soggetto_Assistenza_Fiscale_Doc_Type
children	m730:DataConsegna m730:TipologiaSoggettoAssFisc m730:SostitutoCF m730:DatiCafDoc m730:DatiProfessionistaDoc m730:DatiAssociazioneDoc m730:AgenziaEntrate

element **Documento_730_Type/Documento_730-4**

diagram	
namespace	urn:www.agenziaentrate.gov.it:specificheTecniche:sco:730
type	m730:Documento_730-4
children	m730:DatiAnagraficiDichiarante m730:Sostituto m730:SoggettoAssFiscale730-4 m730:AltriDati m730:DatiContabili730-4

element **Documento_730_Type/EsitiContabili**

diagram	<p>The diagram shows a container element m730:EsitiContabili (dashed box) connected to a connector (hexagon with three dots). This connector is linked to three child elements: m730:Conguaglio, m730:Mod730Integrativo, and m730:VersamentiF24, all shown in dashed boxes with a plus sign icon.</p>
namespace	urn:www.agenziaentrate.gov.it:specificheTecniche:sco:730
children	m730:Conguaglio m730:Mod730Integrativo m730:VersamentiF24

element **Documento_730_Type/EsitiContabili/Conguaglio**

diagram	<p>The diagram shows a container element m730:Conguaglio (dashed box) connected to a connector (hexagon with three dots). This connector is linked to a large dashed box labeled m730:Conguaglio_Type. Inside this box are several child elements: m730:NumeroRate, m730:ImportoTrattenutoSaldo, m730:ImportoTrattenutoAcconto, m730:ImportoDaVersareF24Saldo, m730:ImportoDaVersareF24Acc..., m730:ImportoRimborsato, m730:ImportoRimborsatoAgenzia, and m730:OpzioneInformativa.</p>
namespace	urn:www.agenziaentrate.gov.it:specificheTecniche:sco:730
type	m730:Conguaglio_Type
children	m730:NumeroRate m730:ImportoTrattenutoSaldo m730:ImportoTrattenutoAcconto m730:ImportoDaVersareF24Saldo m730:ImportoDaVersareF24Acconto m730:ImportoRimborsato m730:ImportoRimborsatoAgenzia m730:OpzioneInformativa

element **Documento_730_Type/EsitiContabili/Mod730Integrativo**

<p>diagram</p>	
<p>namespace</p>	<p>urn:www.agenziaentrate.gov.it:specificheTecniche:sco:730</p>
<p>type</p>	<p>m730:Mod730_Integrativo_Type</p>
<p>children</p>	<p>m730:ImportiRimborsare m730:ImportoRimborsato m730:ImportoRimborsatoAgenzia</p>

element **Documento_730_Type/EsitiContabili/VersamentiF24**

<p>diagram</p>	
<p>namespace</p>	<p>urn:www.agenziaentrate.gov.it:specificheTecniche:sco:730</p>
<p>type</p>	<p>m730:Versamenti_F24_Type</p>
<p>children</p>	<p>m730:F24DebitoIrpef m730:F24DebitoCodRegione m730:F24DebitoAddReg m730:F24DebitoCodComune m730:F24DebitoAddCom m730:F24DebitoPrimaRataAcclrpef m730:F24DebitoAccontoTassSep m730:F24DebitoCodComuneAcconto m730:F24DebitoAccontoAddCom m730:F24DebitoCedolare m730:F24DebitoPrimaRataAccCedolare m730:F24DebitoContribSolidarieta m730:F24DebitoCodRegioneConiuge</p>

	m730:F24DebitoAddRegConiuge m730:F24DebitoCodComuneConiuge m730:F24DebitoAddComConiuge m730:F24DebitoCodComuneAccontoConiuge m730:F24DebitoAccontoAddComConiuge m730:F24DebitoSecondaRataAcclrpef m730:F24DebitoSecondaRataAccCedolare
--	--

element **Documento_730_Type/DatiRettificati**

diagram	
namespace	urn:www.agenziaentrate.gov.it:specificheTecniche:sco:730
type	m730:Dati_Rettificati_Type
children	m730:Rettifica

complexType **Domanda_Accatamento_Type**

diagram	
namespace	urn:www.agenziaentrate.gov.it:specificheTecniche:sco:730
children	m730:Data m730:Numero m730:ProvinciaUfficio

element **Domanda_Accatamento_Type/Data**

diagram					
namespace	urn:www.agenziaentrate.gov.it:specificheTecniche:sco:730				
type	DatoDT_Type				
facets	<table border="1"> <thead> <tr> <th>Kind</th> <th>Value</th> </tr> </thead> <tbody> <tr> <td>pattern</td> <td>(((0[1-9][12][0-9][301])(0[13578][1012](\d{4})) ((0[1-9][12][0-9][30](0[469][11](\d{4})) ((0[1-9][1[0-9]]2[0-8])(02)(\d{4})) ((29)(02)([02468][048]00)) ((29)(02)([13579][26]00)) ((29)(02)([0-9][0-9][0][48])) ((29)(02)([0-9][0-9][2468][048])) ((29)(02)([0-9][0-9][13579][26]))))</td> </tr> </tbody> </table>	Kind	Value	pattern	(((0[1-9][12][0-9][301])(0[13578][1012](\d{4})) ((0[1-9][12][0-9][30](0[469][11](\d{4})) ((0[1-9][1[0-9]]2[0-8])(02)(\d{4})) ((29)(02)([02468][048]00)) ((29)(02)([13579][26]00)) ((29)(02)([0-9][0-9][0][48])) ((29)(02)([0-9][0-9][2468][048])) ((29)(02)([0-9][0-9][13579][26]))))
Kind	Value				
pattern	(((0[1-9][12][0-9][301])(0[13578][1012](\d{4})) ((0[1-9][12][0-9][30](0[469][11](\d{4})) ((0[1-9][1[0-9]]2[0-8])(02)(\d{4})) ((29)(02)([02468][048]00)) ((29)(02)([13579][26]00)) ((29)(02)([0-9][0-9][0][48])) ((29)(02)([0-9][0-9][2468][048])) ((29)(02)([0-9][0-9][13579][26]))))				

element **Domanda_Accatamento_Type/Numero**

diagram					
namespace	urn:www.agenziaentrate.gov.it:specificheTecniche:sco:730				
type	DatoAN_Type				
facets	<table border="1"> <thead> <tr> <th>Kind</th> <th>Value</th> </tr> </thead> <tbody> <tr> <td></td> <td></td> </tr> </tbody> </table>	Kind	Value		
Kind	Value				

pattern	(([0-9A-Z\-\]]"){1}([0-9A-Z&#92; ' \- \., / ^ \^\(\ \)\ À É È Ì Ò Ù Ú " \ \ \ +)*
---------	--

element **Domanda_Accatastamento_Type/ProvinciaUfficio**

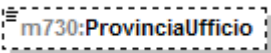
diagram	
namespace	urn:www.agenziaentrate.gov.it:specificheTecniche:sco:730
type	PN_Type

complexType **Domicilio_Fiscale_Type**

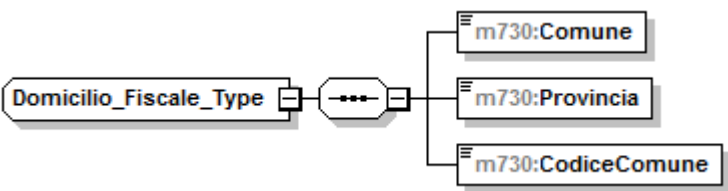
diagram	
namespace	urn:www.agenziaentrate.gov.it:specificheTecniche:sco:730
children	m730:Comune m730:Provincia m730:CodiceComune

element **Domicilio_Fiscale_Type/Comune**

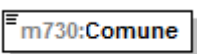
diagram	
namespace	urn:www.agenziaentrate.gov.it:specificheTecniche:sco:730
type	DatoAN_Type
facets	Kind Value pattern (([0-9A-Z\-\]]"){1}([0-9A-Z&#92; ' \- \., / ^ \^\(\ \)\ À É È Ì Ò Ù Ú " \ \ \ +)*

element **Domicilio_Fiscale_Type/Provincia**

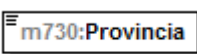
diagram	
namespace	urn:www.agenziaentrate.gov.it:specificheTecniche:sco:730
type	PR_Type

element **Domicilio_Fiscale_Type/CodiceComune**

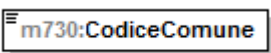
diagram	
namespace	urn:www.agenziaentrate.gov.it:specificheTecniche:sco:730
type	DatoAN_Type

facets	Kind	Value
	pattern	([0-9A-Z\-\]\"){1}([0-9A-Z&#39; ! \- \., / ° °\°\(\) À É È Ì Ò Ù Û " \ \\ \ +)*

complexType Domicilio_Sogg_Ass_Fiscale_Type

diagram	
namespace	urn:www.agenziaentrate.gov.it:specificheTecniche:sco:730
children	m730:Comune m730:Provincia m730:CodiceComune m730:Cap m730:Indirizzo m730:Telefono m730:FAX m730:Email

element Domicilio_Sogg_Ass_Fiscale_Type/Comune

diagram	
namespace	urn:www.agenziaentrate.gov.it:specificheTecniche:sco:730
type	DatoAN_Type
facets	Kind Value pattern ([0-9A-Z\-\]\"){1}([0-9A-Z&#39; ! \- \., / ° °\°\(\) À É È Ì Ò Ù Û " \ \\ \ +)*

element Domicilio_Sogg_Ass_Fiscale_Type/Provincia

diagram	
namespace	urn:www.agenziaentrate.gov.it:specificheTecniche:sco:730
type	PR_Type

element Domicilio_Sogg_Ass_Fiscale_Type/CodiceComune

diagram	
---------	--

namespace	urn:www.agenziaentrate.gov.it:specificheTecniche:sco:730
type	DatoAN_Type
facets	Kind Value pattern ([0-9A-Z\-\]*)"}{1}([0-9A-Z&:] \- \., / ^ \^\(\ \)\ À É È Ì Ò Ù Ü " \ \ \ +)*

element **Domicilio_Sogg_Ass_Fiscale_Type/Cap**

diagram	
namespace	urn:www.agenziaentrate.gov.it:specificheTecniche:sco:730
type	DatoAN_Type
facets	Kind Value pattern ([0-9A-Z\-\]*)"}{1}([0-9A-Z&:] \- \., / ^ \^\(\ \)\ À É È Ì Ò Ù Ü " \ \ \ +)*

element **Domicilio_Sogg_Ass_Fiscale_Type/Indirizzo**

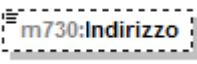
diagram	
namespace	urn:www.agenziaentrate.gov.it:specificheTecniche:sco:730
type	DatoAN_Type
facets	Kind Value pattern ([0-9A-Z\-\]*)"}{1}([0-9A-Z&:] \- \., / ^ \^\(\ \)\ À É È Ì Ò Ù Ü " \ \ \ +)*

element **Domicilio_Sogg_Ass_Fiscale_Type/Telefono**

diagram	
namespace	urn:www.agenziaentrate.gov.it:specificheTecniche:sco:730
type	DatoAN_Type
facets	Kind Value pattern ([0-9A-Z\-\]*)"}{1}([0-9A-Z&:] \- \., / ^ \^\(\ \)\ À É È Ì Ò Ù Ü " \ \ \ +)*

element **Domicilio_Sogg_Ass_Fiscale_Type/FAX**

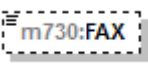
diagram	
namespace	urn:www.agenziaentrate.gov.it:specificheTecniche:sco:730
type	DatoAN_Type
facets	Kind Value pattern ([0-9A-Z\-\]*)"}{1}([0-9A-Z&:] \- \., / ^ \^\(\ \)\ À É È Ì Ò Ù Ü " \ \ \ +)*

element **Domicilio_Sogg_Ass_Fiscale_Type/Email**

diagram	
namespace	urn:www.agenziaentrate.gov.it:specificheTecniche:sco:730
type	DatoEM_Type
facets	Kind Value pattern [a-zA-Z0-9._%'\-'\"?^~=]+@[a-zA-Z0-9.\-]+\.[a-zA-Z]{2,4}

complexType **Eccedenze_Type**

diagram	
namespace	urn:www.agenziaentrate.gov.it:specificheTecniche:sco:730
children	m730:Irpef m730:IrpefCompF24 m730:SostitutivaQuadroRT m730:SostitutivaQuadroRTcompF24 m730:CedolareSecca m730:CedolareSeccaCompF24 m730:CodiceRegione m730:AddRegionaleIrpef m730:AddRegionaleIrpefCompF24 m730:CodiceCatastaleComune m730:AddComunaleIrpef m730:AddComunaleIrpefF24

element **Eccedenze_Type/Irpef**

diagram	
namespace	urn:www.agenziaentrate.gov.it:specificheTecniche:sco:730
type	DatoNP_Type
facets	Kind Value

	pattern [1-9]{1}[0-9]*
--	------------------------

element **Eccedenze_Type/IrpefCompF24**

diagram	
namespace	urn:www.agenziaentrate.gov.it:specificheTecniche:sco:730
type	DatoNP_Type
facets	Kind Value pattern [1-9]{1}[0-9]*

element **Eccedenze_Type/SostitutivaQuadroRT**

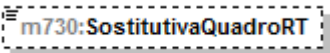
diagram	
namespace	urn:www.agenziaentrate.gov.it:specificheTecniche:sco:730
type	DatoNP_Type
facets	Kind Value pattern [1-9]{1}[0-9]*

element **Eccedenze_Type/SostitutivaQuadroRTcompF24**

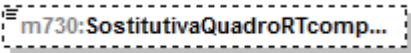
diagram	
namespace	urn:www.agenziaentrate.gov.it:specificheTecniche:sco:730
type	DatoNP_Type
facets	Kind Value pattern [1-9]{1}[0-9]*

element **Eccedenze_Type/CedolareSecca**

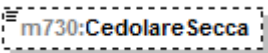
diagram	
namespace	urn:www.agenziaentrate.gov.it:specificheTecniche:sco:730
type	DatoNP_Type
facets	Kind Value pattern [1-9]{1}[0-9]*

element **Eccedenze_Type/CedolareSeccaCompF24**

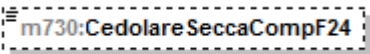
diagram	
namespace	urn:www.agenziaentrate.gov.it:specificheTecniche:sco:730
type	DatoNP_Type

facets	Kind	Value
	pattern	[1-9]{1}[0-9]*

element **Eccedenze_Type/CodiceRegione**

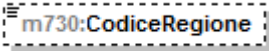
diagram		
namespace	urn:www.agenziaentrate.gov.it:specificheTecniche:sco:730	
type	Codice Regione Type	
facets	Kind	Value
	pattern	([0-9A-Z\-\]"){1}([0-9A-Z&] \- \., / \° \^ \(\) À È É ì Ò Ù Ü "; \\ / +)*
	enumeration	1
	enumeration	2
	enumeration	3
	enumeration	4
	enumeration	5
	enumeration	6
	enumeration	7
	enumeration	8
	enumeration	9
	enumeration	10
	enumeration	11
	enumeration	12
	enumeration	13
	enumeration	14
	enumeration	15
	enumeration	16
	enumeration	17
	enumeration	18
	enumeration	19
	enumeration	20
	enumeration	21

element **Eccedenze_Type/AddRegionalelrpef**

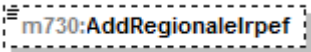
diagram		
namespace	urn:www.agenziaentrate.gov.it:specificheTecniche:sco:730	
type	DatoNP Type	
facets	Kind	Value
	pattern	[1-9]{1}[0-9]*

element **Eccedenze_Type/AddRegionalelrpefCompF24**

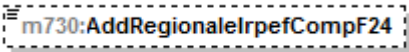
diagram		
namespace	urn:www.agenziaentrate.gov.it:specificheTecniche:sco:730	
type	DatoNP Type	
facets	Kind	Value
	pattern	[1-9]{1}[0-9]*

element **Eccedenze_Type/CodiceCatastaleComune**

diagram	
namespace	urn:www.agenziaentrate.gov.it:specificheTecniche:sco:730
type	restriction of DatoAN_Type
facets	Kind Value pattern <code>(([0-9A-Z-])&quot;){1}([0-9A-Z&amp;:] ' - \., / ^\\(\\) À É È Ì Ò Ù Û &quot; \\ \\ \\ +)*</code>

element **Eccedenze_Type/AddComunalelrpef**

diagram	
namespace	urn:www.agenziaentrate.gov.it:specificheTecniche:sco:730
type	DatoNP_Type
facets	Kind Value pattern <code>[1-9]{1}[0-9]*</code>

element **Eccedenze_Type/AddComunalelrpefF24**

diagram	
namespace	urn:www.agenziaentrate.gov.it:specificheTecniche:sco:730
type	DatoNP_Type
facets	Kind Value pattern <code>[1-9]{1}[0-9]*</code>

complexType **Elemento_Integrativo_Type**

diagram	
namespace	urn:www.agenziaentrate.gov.it:specificheTecniche:sco:730
children	m730:lrpef m730:AddizionaleRegionalelrpef m730:AddComunalelrpef m730:CedolareSecca

element **Elemento_Integrativo_Type/lrpef**

diagram	
namespace	urn:www.agenziaentrate.gov.it:specificheTecniche:sco:730

type	DatoNP_Type
facets	Kind Value pattern [1-9]{1}[0-9]*

element **Elemento_Integrativo_Type/AddizionaleRegionaleIrpef**

diagram	
namespace	urn:www.agenziaentrate.gov.it:specificheTecniche:sco:730
type	DatoNP_Type
facets	Kind Value pattern [1-9]{1}[0-9]*

element **Elemento_Integrativo_Type/AddComunaleIrpef**

diagram	
namespace	urn:www.agenziaentrate.gov.it:specificheTecniche:sco:730
type	DatoNP_Type
facets	Kind Value pattern [1-9]{1}[0-9]*

element **Elemento_Integrativo_Type/CedolareSecca**

diagram	
namespace	urn:www.agenziaentrate.gov.it:specificheTecniche:sco:730
type	DatoNP_Type
facets	Kind Value pattern [1-9]{1}[0-9]*

complexType **Esenzione_Add_Comunale_Type**

diagram	
namespace	urn:www.agenziaentrate.gov.it:specificheTecniche:sco:730
children	m730:SogliaEsenzioneSaldo m730:SogliaEsenzioneAcconto

element **Esenzione_Add_Comunale_Type/SogliaEsenzioneSaldo**

diagram	
namespace	urn:www.agenziaentrate.gov.it:specificheTecniche:sco:730
type	m730:Soglie_Esenzione_Type
children	m730:SogliaEsenzione m730:EsenzioneTotale

element **Esenzione_Add_Comunale_Type/SogliaEsenzioneAcconto**

diagram	
namespace	urn:www.agenziaentrate.gov.it:specificheTecniche:sco:730
type	m730:Soglie_Esenzione_Type
children	m730:SogliaEsenzione m730:EsenzioneTotale

complexType **Esenzione_Bonus_Type**

diagram	
namespace	urn:www.agenziaentrate.gov.it:specificheTecniche:sco:730
children	m730:TipologiaEsenzione m730:ParteRedditoEsente

element **Esenzione_Bonus_Type/TipologiaEsenzione**

diagram									
namespace	urn:www.agenziaentrate.gov.it:specificheTecniche:sco:730								
type	restriction of DatoN1_Type								
facets	<table border="1"> <thead> <tr> <th>Kind</th> <th>Value</th> </tr> </thead> <tbody> <tr> <td>pattern</td> <td>[1-9]</td> </tr> <tr> <td>enumeration</td> <td>1</td> </tr> <tr> <td>enumeration</td> <td>2</td> </tr> </tbody> </table>	Kind	Value	pattern	[1-9]	enumeration	1	enumeration	2
Kind	Value								
pattern	[1-9]								
enumeration	1								
enumeration	2								

element **Esenzione_Bonus_Type/ParteRedditoEsente**

diagram					
namespace	urn:www.agenziaentrate.gov.it:specificheTecniche:sco:730				
type	DatoNP_Type				
facets	<table border="1"> <tr> <td>Kind</td> <td>Value</td> </tr> <tr> <td>pattern</td> <td>[1-9]{1}[0-9]*</td> </tr> </table>	Kind	Value	pattern	[1-9]{1}[0-9]*
Kind	Value				
pattern	[1-9]{1}[0-9]*				

complexType **Esito_Liquidazione_Type**

diagram	
namespace	urn:www.agenziaentrate.gov.it:specificheTecniche:sco:730
children	m730:Credito m730:Debito

element **Esito_Liquidazione_Type/Credito**

diagram	
namespace	urn:www.agenziaentrate.gov.it:specificheTecniche:sco:730
type	m730:Credito_Type
children	m730:NonRimborsabile m730:Credito m730:CreditoF24 m730:CreditoRimborso

element **Esito_Liquidazione_Type/Debito**

diagram	
namespace	urn:www.agenziaentrate.gov.it:specificheTecniche:sco:730

type	m730:Debito_Type
children	m730:NonVersare m730:ImportoDaTrattenere

complexType **Fabbricato_Agev_Type**

diagram	
namespace	urn:www.agenziaentrate.gov.it:specificheTecniche:sco:730
children	m730:NumeroRigoRiferimento m730:NumModuloRiferimento m730:DatiContratto m730:CasellaInf30Giorni m730:AnnoDichiarazioneIcilmu m730:StatoEmergenza

element **Fabbricato_Agev_Type/NumeroRigoRiferimento**

diagram																									
namespace	urn:www.agenziaentrate.gov.it:specificheTecniche:sco:730																								
type	m730:Fabbricato_Agev_Numero_Rigo_Type																								
facets	<table border="1"> <thead> <tr> <th>Kind</th> <th>Value</th> </tr> </thead> <tbody> <tr> <td>pattern</td> <td>[1-9]{1}[0-9]*</td> </tr> <tr> <td>enumeration</td> <td>1</td> </tr> <tr> <td>enumeration</td> <td>2</td> </tr> <tr> <td>enumeration</td> <td>3</td> </tr> <tr> <td>enumeration</td> <td>4</td> </tr> <tr> <td>enumeration</td> <td>5</td> </tr> <tr> <td>enumeration</td> <td>6</td> </tr> <tr> <td>enumeration</td> <td>7</td> </tr> <tr> <td>enumeration</td> <td>8</td> </tr> <tr> <td>enumeration</td> <td>9</td> </tr> <tr> <td>enumeration</td> <td>10</td> </tr> </tbody> </table>	Kind	Value	pattern	[1-9]{1}[0-9]*	enumeration	1	enumeration	2	enumeration	3	enumeration	4	enumeration	5	enumeration	6	enumeration	7	enumeration	8	enumeration	9	enumeration	10
Kind	Value																								
pattern	[1-9]{1}[0-9]*																								
enumeration	1																								
enumeration	2																								
enumeration	3																								
enumeration	4																								
enumeration	5																								
enumeration	6																								
enumeration	7																								
enumeration	8																								
enumeration	9																								
enumeration	10																								

element **Fabbricato_Agev_Type/NumModuloRiferimento**

diagram					
namespace	urn:www.agenziaentrate.gov.it:specificheTecniche:sco:730				
type	DatoNP_Type				
facets	<table border="1"> <thead> <tr> <th>Kind</th> <th>Value</th> </tr> </thead> <tbody> <tr> <td>pattern</td> <td>[1-9]{1}[0-9]*</td> </tr> </tbody> </table>	Kind	Value	pattern	[1-9]{1}[0-9]*
Kind	Value				
pattern	[1-9]{1}[0-9]*				

element **Fabbricato_Agev_Type/DatiContratto**

diagram	
namespace	urn:www.agenziaentrate.gov.it:specificheTecniche:sco:730
type	extension of m730:Dati_Contratto_Type
children	m730:DataRegContratto m730:SerieContratto m730:NumeroContratto m730:Sottonumero m730:CodiceUfficio m730:IdentificativoContratto

element **Fabbricato_Agev_Type/DatiContratto/IdentificativoContratto**

diagram					
namespace	urn:www.agenziaentrate.gov.it:specificheTecniche:sco:730				
type	DatoAN_Type				
facets	<table border="0"> <tr> <td>Kind</td> <td>Value</td> </tr> <tr> <td>pattern</td> <td>(([0-9A-Z\-_]&quot;){1}([0-9A-Z&amp;:] \- \., / \^\(\ \)\ À É É Ì Ò Ù Û &quot; \ \\ \ +)*</td> </tr> </table>	Kind	Value	pattern	(([0-9A-Z\-_]"){1}([0-9A-Z&:] \- \., / \^\(\ \)\ À É É Ì Ò Ù Û " \ \\ \ +)*
Kind	Value				
pattern	(([0-9A-Z\-_]"){1}([0-9A-Z&:] \- \., / \^\(\ \)\ À É É Ì Ò Ù Û " \ \\ \ +)*				

element **Fabbricato_Agev_Type/CasellaInf30Giorni**

diagram					
namespace	urn:www.agenziaentrate.gov.it:specificheTecniche:sco:730				
type	DatoCB_Type				
facets	<table border="0"> <tr> <td>Kind</td> <td>Value</td> </tr> <tr> <td>pattern</td> <td>[01]</td> </tr> </table>	Kind	Value	pattern	[01]
Kind	Value				
pattern	[01]				

element **Fabbricato_Agev_Type/AnnoDichiarazioneIcilmu**

diagram	
---------	--

namespace	urn:www.agenziaentrate.gov.it:specificheTecniche:sco:730
type	DatoDA Type
facets	Kind Value pattern (18 19 20)[0-9]{2}

element **Fabbricato_Agev_Type/StatoEmergenza**

diagram	
namespace	urn:www.agenziaentrate.gov.it:specificheTecniche:sco:730
type	DatoCB Type
facets	Kind Value pattern [01]

complexType **Fabbricato_Ord_Type**

diagram	
namespace	urn:www.agenziaentrate.gov.it:specificheTecniche:sco:730
children	m730:Rendita m730:Utilizzo m730:GiorniPossesso m730:PercPossesso m730:CodiceCanone m730:CanoneLocazione m730:CasiParticolari m730:CasellaContinuazione m730:CodiceComune m730:OpzioneCedolare m730:CasellaCasiPartimu

element **Fabbricato_Ord_Type/Rendita**

diagram	
---------	--

namespace	urn:www.agenziaentrate.gov.it:specificheTecniche:sco:730
type	DatoNP_Type
facets	Kind Value pattern [1-9]{1}[0-9]*

element **Fabbricato_Ord_Type/Utilizzo**

diagram	
namespace	urn:www.agenziaentrate.gov.it:specificheTecniche:sco:730
type	restriction of m730:Utilizzo Fabbricato_Type
facets	Kind Value pattern [1-9]{1}[0-9]* enumeration 1 enumeration 2 enumeration 3 enumeration 4 enumeration 5 enumeration 8 enumeration 9 enumeration 10 enumeration 11 enumeration 12 enumeration 14 enumeration 15 enumeration 16 enumeration 17

element **Fabbricato_Ord_Type/GiorniPossesso**

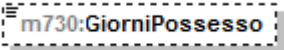
diagram	
namespace	urn:www.agenziaentrate.gov.it:specificheTecniche:sco:730
type	restriction of DatoNP_Type
facets	Kind Value pattern [1-9]{1}[0-9]*

element **Fabbricato_Ord_Type/PercPossesso**

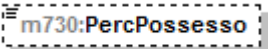
diagram	
namespace	urn:www.agenziaentrate.gov.it:specificheTecniche:sco:730
type	DatoPC_Type
facets	Kind Value pattern [0-9]?[0-9](,\d{1,3})? 100,(0{1,3})?

element **Fabbricato_Ord_Type/CodiceCanone**

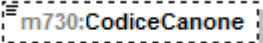
diagram													
namespace	urn:www.agenziaentrate.gov.it:specificheTecniche:sco:730												
type	m730:Codice Canone Type												
facets	<table border="1"> <thead> <tr> <th>Kind</th> <th>Value</th> </tr> </thead> <tbody> <tr> <td>pattern</td> <td>[1-9]</td> </tr> <tr> <td>enumeration</td> <td>1</td> </tr> <tr> <td>enumeration</td> <td>2</td> </tr> <tr> <td>enumeration</td> <td>3</td> </tr> <tr> <td>enumeration</td> <td>4</td> </tr> </tbody> </table>	Kind	Value	pattern	[1-9]	enumeration	1	enumeration	2	enumeration	3	enumeration	4
Kind	Value												
pattern	[1-9]												
enumeration	1												
enumeration	2												
enumeration	3												
enumeration	4												

element **Fabbricato_Ord_Type/CanoneLocazione**

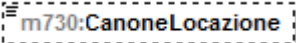
diagram					
namespace	urn:www.agenziaentrate.gov.it:specificheTecniche:sco:730				
type	DatoNP Type				
facets	<table border="1"> <thead> <tr> <th>Kind</th> <th>Value</th> </tr> </thead> <tbody> <tr> <td>pattern</td> <td>[1-9]{1}[0-9]*</td> </tr> </tbody> </table>	Kind	Value	pattern	[1-9]{1}[0-9]*
Kind	Value				
pattern	[1-9]{1}[0-9]*				

element **Fabbricato_Ord_Type/CasiParticolari**

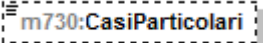
diagram															
namespace	urn:www.agenziaentrate.gov.it:specificheTecniche:sco:730														
type	m730:Casi Particolari Fabbricato Type														
facets	<table border="1"> <thead> <tr> <th>Kind</th> <th>Value</th> </tr> </thead> <tbody> <tr> <td>pattern</td> <td>[1-9]</td> </tr> <tr> <td>enumeration</td> <td>1</td> </tr> <tr> <td>enumeration</td> <td>3</td> </tr> <tr> <td>enumeration</td> <td>4</td> </tr> <tr> <td>enumeration</td> <td>5</td> </tr> <tr> <td>enumeration</td> <td>6</td> </tr> </tbody> </table>	Kind	Value	pattern	[1-9]	enumeration	1	enumeration	3	enumeration	4	enumeration	5	enumeration	6
Kind	Value														
pattern	[1-9]														
enumeration	1														
enumeration	3														
enumeration	4														
enumeration	5														
enumeration	6														

element **Fabbricato_Ord_Type/CasellaContinuazione**

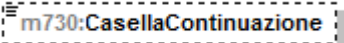
diagram					
namespace	urn:www.agenziaentrate.gov.it:specificheTecniche:sco:730				
type	DatoCB Type				
facets	<table border="1"> <thead> <tr> <th>Kind</th> <th>Value</th> </tr> </thead> <tbody> <tr> <td>pattern</td> <td>[01]</td> </tr> </tbody> </table>	Kind	Value	pattern	[01]
Kind	Value				
pattern	[01]				

element **Fabbricato_Ord_Type/CodiceComune**

diagram					
namespace	urn:www.agenziaentrate.gov.it:specificheTecniche:sco:730				
type	restriction of DatoAN_Type				
facets	<table border="1"> <tr> <td>Kind</td> <td>Value</td> </tr> <tr> <td>pattern</td> <td>(([0-9A-Z-] \&quot;){1}([0-9A-Z&amp;:] \- \., / \^\(\ \)\À É È Ì Ò Ù Û \&quot; \ \\ \ +)*</td> </tr> </table>	Kind	Value	pattern	(([0-9A-Z-] \"){1}([0-9A-Z&:] \- \., / \^\(\ \)\À É È Ì Ò Ù Û \" \ \\ \ +)*
Kind	Value				
pattern	(([0-9A-Z-] \"){1}([0-9A-Z&:] \- \., / \^\(\ \)\À É È Ì Ò Ù Û \" \ \\ \ +)*				

element **Fabbricato_Ord_Type/OpzioneCedolare**

diagram					
namespace	urn:www.agenziaentrate.gov.it:specificheTecniche:sco:730				
type	DatoCB_Type				
facets	<table border="1"> <tr> <td>Kind</td> <td>Value</td> </tr> <tr> <td>pattern</td> <td>[01]</td> </tr> </table>	Kind	Value	pattern	[01]
Kind	Value				
pattern	[01]				

element **Fabbricato_Ord_Type/CasellaCasiPartImu**

diagram											
namespace	urn:www.agenziaentrate.gov.it:specificheTecniche:sco:730										
type	restriction of DatoN1_Type										
facets	<table border="1"> <tr> <td>Kind</td> <td>Value</td> </tr> <tr> <td>pattern</td> <td>[1-9]</td> </tr> <tr> <td>enumeration</td> <td>1</td> </tr> <tr> <td>enumeration</td> <td>2</td> </tr> <tr> <td>enumeration</td> <td>3</td> </tr> </table>	Kind	Value	pattern	[1-9]	enumeration	1	enumeration	2	enumeration	3
Kind	Value										
pattern	[1-9]										
enumeration	1										
enumeration	2										
enumeration	3										

complexType **Familiari_Type**

diagram	
namespace	urn:www.agenziaentrate.gov.it:specificheTecniche:sco:730
children	m730:PrimoModulo m730:Modulo

element **Familiari_Type/PrimoModulo**

diagram	
namespace	urn:www.agenziaentrate.gov.it:specificheTecniche:sco:730
type	m730:Primo_Modulo_Familiari_Type
children	m730:Coniuge m730:PrimoFiglio m730:Familiari m730:PercUlteriore m730:FigliAffidoPread

element **Familiari_Type/Modulo**

diagram	
namespace	urn:www.agenziaentrate.gov.it:specificheTecniche:sco:730
type	m730:Modulo_Familiari_Type
children	m730:Coniuge m730:PrimoFiglio m730:Familiari

complexType **Firma_Dichiarazione_Type**

diagram	
namespace	urn:www.agenziaentrate.gov.it:specificheTecniche:sco:730
children	m730:NumeroModelli m730:FirmaDichiarazione m730:OpzioneInformativa m730:SoggettoFiscalmenteCarico m730:QuadroK

element **Firma_Dichiarazione_Type/NumeroModelli**

diagram					
namespace	urn:www.agenziaentrate.gov.it:specificheTecniche:sco:730				
type	DatoNP_Type				
facets	<table border="1"> <tr> <td>Kind</td> <td>Value</td> </tr> <tr> <td>pattern</td> <td>[1-9]{1}[0-9]*</td> </tr> </table>	Kind	Value	pattern	[1-9]{1}[0-9]*
Kind	Value				
pattern	[1-9]{1}[0-9]*				

element **Firma_Dichiarazione_Type/FirmaDichiarazione**

diagram					
namespace	urn:www.agenziaentrate.gov.it:specificheTecniche:sco:730				
type	DatoCB_Type				
facets	<table border="1"> <tr> <td>Kind</td> <td>Value</td> </tr> <tr> <td>pattern</td> <td>[01]</td> </tr> </table>	Kind	Value	pattern	[01]
Kind	Value				
pattern	[01]				

element **Firma_Dichiarazione_Type/OpzioneInformativa**

diagram					
namespace	urn:www.agenziaentrate.gov.it:specificheTecniche:sco:730				
type	DatoCB_Type				
facets	<table border="1"> <tr> <td>Kind</td> <td>Value</td> </tr> <tr> <td>pattern</td> <td>[01]</td> </tr> </table>	Kind	Value	pattern	[01]
Kind	Value				
pattern	[01]				

element **Firma_Dichiarazione_Type/SoggettoFiscalmenteCarico**

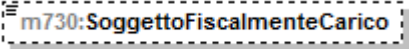
diagram	
namespace	urn:www.agenziaentrate.gov.it:specificheTecniche:sco:730
type	DatoCB_Type
facets	Kind Value pattern [01]

element **Firma_Dichiarazione_Type/QuadroK**

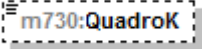
diagram	
namespace	urn:www.agenziaentrate.gov.it:specificheTecniche:sco:730
type	DatoCB_Type
facets	Kind Value pattern [01]

complexType **Fondo_Pensione_Dipendenti_Pubblici_Type**

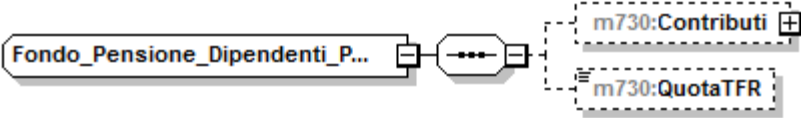
diagram	
namespace	urn:www.agenziaentrate.gov.it:specificheTecniche:sco:730
children	m730:Contributi m730:QuotaTFR

element **Fondo_Pensione_Dipendenti_Pubblici_Type/Contributi**

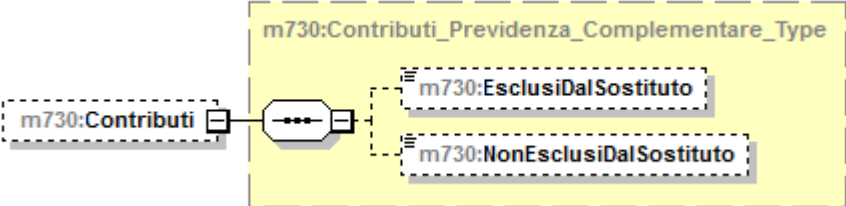
diagram	
namespace	urn:www.agenziaentrate.gov.it:specificheTecniche:sco:730
type	m730:Contributi Previdenza Complementare_Type
children	m730:EsclusiDalSostituto m730:NonEsclusiDalSostituto

element **Fondo_Pensione_Dipendenti_Pubblici_Type/QuotaTFR**

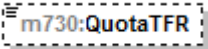
diagram	
---------	---

namespace	urn:www.agenziaentrate.gov.it:specificheTecniche:sco:730
type	DatoNP_Type
facets	Kind Value pattern [1-9]{1}[0-9]*

complexType Frontespizio_730_Type

diagram	
namespace	urn:www.agenziaentrate.gov.it:specificheTecniche:sco:730
children	m730:SoggettoFiscale m730:DatiAnagrafici m730:StatoCivile m730:ResidenzaAnagrafica m730:DomicilioFiscale01012015 m730:DomicilioFiscale01012016 m730:CasiParticolariAddizionale m730:Firma

element Frontespizio_730_Type/SoggettoFiscale

diagram	
namespace	urn:www.agenziaentrate.gov.it:specificheTecniche:sco:730
type	m730:Soggetto_Fiscale_730_Type
children	m730:CodiceFiscale m730:Email m730:Telefono m730:Cellulare

element **Frontespizio_730_Type/DatiAnagrafici**

diagram	<p>The diagram illustrates the structure of the <code>m730:DatiAnagrafici</code> element. It is connected to a container labeled <code>sc:Dati_Anagrafici_Type</code>. This container contains several fields: <code>Cognome</code>, <code>Nome</code>, <code>Sesso</code>, <code>DataNascita</code>, <code>ComuneNascita</code>, and <code>ProvinciaNascita</code>. The <code>ProvinciaNascita</code> field is shown with a dashed border, indicating it is optional.</p>
namespace	urn:www.agenziaentrate.gov.it:specificheTecniche:sco:730
type	Dati_Anagrafici_Type
children	Cognome Nome Sesso DataNascita ComuneNascita ProvinciaNascita

element **Frontespizio_730_Type/StatoCivile**

diagram	<p>The diagram shows the <code>m730:StatoCivile</code> element enclosed in a dashed box, indicating it is optional.</p>								
namespace	urn:www.agenziaentrate.gov.it:specificheTecniche:sco:730								
type	m730:Stato_Civile_Type								
facets	<table border="1"> <thead> <tr> <th>Kind</th> <th>Value</th> </tr> </thead> <tbody> <tr> <td>pattern</td> <td>[1-9]{1}[0-9]*</td> </tr> <tr> <td>enumeration</td> <td>7</td> </tr> <tr> <td>enumeration</td> <td>8</td> </tr> </tbody> </table>	Kind	Value	pattern	[1-9]{1}[0-9]*	enumeration	7	enumeration	8
Kind	Value								
pattern	[1-9]{1}[0-9]*								
enumeration	7								
enumeration	8								

element Frontespizio_730_Type/ResidenzaAnagrafica

<p>diagram</p>	
<p>namespace</p>	<p>urn:www.agenziaentrate.gov.it:specificheTecniche:sco:730</p>
<p>type</p>	<p>m730:Residenza_Anagrafica_730_Type</p>
<p>children</p>	<p>Comune Provincia CodiceComune Indirizzo Cap DataVariazione m730:Tipologia m730:NumCivico m730:Frazione m730:PrimaPresentazione</p>

element Frontespizio_730_Type/DomicilioFiscale01012015

<p>diagram</p>	
<p>namespace</p>	<p>urn:www.agenziaentrate.gov.it:specificheTecniche:sco:730</p>
<p>type</p>	<p>m730:Domicilio_Fiscale_Type</p>
<p>children</p>	<p>m730:Comune m730:Provincia m730:CodiceComune</p>

element **Frontespizio_730_Type/DomicilioFiscale01012016**

diagram	
namespace	urn:www.agenziaentrate.gov.it:specificheTecniche:sco:730
type	m730:Domicilio_Fiscale_Type
children	m730:Comune m730:Provincia m730:CodiceComune

element **Frontespizio_730_Type/CasiParticolariAddizionale**

diagram					
namespace	urn:www.agenziaentrate.gov.it:specificheTecniche:sco:730				
type	DatoCB_Type				
facets	<table border="1"> <thead> <tr> <th>Kind</th> <th>Value</th> </tr> </thead> <tbody> <tr> <td>pattern</td> <td>[01]</td> </tr> </tbody> </table>	Kind	Value	pattern	[01]
Kind	Value				
pattern	[01]				

element **Frontespizio_730_Type/Firma**

diagram	
namespace	urn:www.agenziaentrate.gov.it:specificheTecniche:sco:730
type	m730:Firma_Dichiarazione_Type
children	m730:NumeroModelli m730:FirmaDichiarazione m730:OpzioneInformativa m730:SoggettoFiscalmenteCarico m730:QuadroK

complexType Frontespizio_Con_Type

diagram	
namespace	urn:www.agenziaentrate.gov.it:specificheTecniche:sco:730
type	extension of m730:Frontespizio_730_Type
children	m730:SoggettoFiscale m730:DatiAnagrafici m730:StatoCivile m730:ResidenzaAnagrafica m730:DomicilioFiscale01012015 m730:DomicilioFiscale01012016 m730:CasiParticolariAddizionale m730:Firma

complexType Frontespizio_Dich_Type

diagram	
---------	--

namespace	urn:www.agenziaentrate.gov.it:specificheTecniche:sco:730
type	extension of m730:Frontespizio_730_Type
children	m730:SoggettoFiscale m730:DatiAnagrafici m730:StatoCivile m730:ResidenzaAnagrafica m730:DomicilioFiscale01012015 m730:DomicilioFiscale01012016 m730:CasiParticolariAddizionale m730:Firma m730:Rappresentante

element **Frontespizio_Dich_Type/Rappresentante**

diagram	
namespace	urn:www.agenziaentrate.gov.it:specificheTecniche:sco:730
type	m730:Rappresentante_Type
children	m730:SoggettoFiscale m730:DatiAnagrafici m730:ResidenzaAnagrafica m730:Firma

complexType **Fuori_Assistenza_Type**

diagram	
namespace	urn:www.agenziaentrate.gov.it:specificheTecniche:sco:730
children	m730:AnomaliaDatianagrafici m730:AnomaliaTerreni m730:AnomaliaFabbricati m730:AnomaliaLavDip m730:AnomaliaAltriRedditi m730:AnomaliaQuadroF

element **Fuori_Assistenza_Type/AnomaliaDatianagrafici**

diagram	
---------	--

namespace	urn:www.agenziaentrate.gov.it:specificheTecniche:sco:730
type	DatoCB_Type
facets	Kind Value pattern [01]

element **Fuori_Assistenza_Type/AnomaliaTerreni**

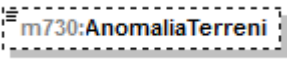
diagram	
namespace	urn:www.agenziaentrate.gov.it:specificheTecniche:sco:730
type	DatoCB_Type
facets	Kind Value pattern [01]

element **Fuori_Assistenza_Type/AnomaliaFabbricati**

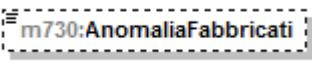
diagram	
namespace	urn:www.agenziaentrate.gov.it:specificheTecniche:sco:730
type	DatoCB_Type
facets	Kind Value pattern [01]

element **Fuori_Assistenza_Type/AnomaliaLavDip**

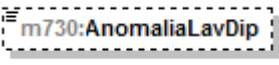
diagram	
namespace	urn:www.agenziaentrate.gov.it:specificheTecniche:sco:730
type	DatoCB_Type
facets	Kind Value pattern [01]

element **Fuori_Assistenza_Type/AnomaliaAltriRedditi**

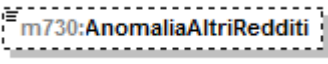
diagram	
namespace	urn:www.agenziaentrate.gov.it:specificheTecniche:sco:730
type	DatoCB_Type
facets	Kind Value pattern [01]

element **Fuori_Assistenza_Type/AnomaliaQuadroF**

diagram	
namespace	urn:www.agenziaentrate.gov.it:specificheTecniche:sco:730
type	DatoCB_Type
facets	Kind Value pattern [01]

complexType **Giorni_Percentuale_Type**

diagram	
namespace	urn:www.agenziaentrate.gov.it:specificheTecniche:sco:730
children	m730:Giorni m730:Percentuale

element **Giorni_Percentuale_Type/Giorni**

diagram	
namespace	urn:www.agenziaentrate.gov.it:specificheTecniche:sco:730
type	DatoNP_Type
facets	Kind Value pattern [1-9]{1}[0-9]*

element **Giorni_Percentuale_Type/Percentuale**

diagram	
namespace	urn:www.agenziaentrate.gov.it:specificheTecniche:sco:730
type	DatoPC_Type
facets	Kind Value pattern [0-9]?[0-9](, d{1,3})? 100(,0{1,3})?

complexType **Importi_Rimborsare_730-4_Integrativo_Type**

diagram	
namespace	urn:www.agenziaentrate.gov.it:specificheTecniche:sco:730
type	extension of m730:Importi_Rimborsare_730-4_Type
children	m730:IrpefRimborsare m730:AddRegRimborsare m730:AddComRimborsare m730:CedolareRimborsare m730:TassazioneSepRimborsare m730:ContributoSolidarieta

element **Importi_Rimborsare_730-4_Integrativo_Type/TassazioneSepRimborsare**

diagram	
namespace	urn:www.agenziaentrate.gov.it:specificheTecniche:sco:730
type	m730:Importo_730-4
children	m730:ImportoDichiarante m730:ImportoConiuge m730:ImportoTotale

element **Importi_Rimborsare_730-4_Integrativo_Type/ContributoSolidarieta**

diagram	
namespace	urn:www.agenziaentrate.gov.it:specificheTecniche:sco:730
type	m730:Importo_730-4
children	m730:ImportoDichiarante m730:ImportoConiuge m730:ImportoTotale

complexType **Importi_Rimborsare_730-4_Type**

diagram	
namespace	urn:www.agenziaentrate.gov.it:specificheTecniche:sco:730
children	m730:IrpefRimborsare m730:AddRegRimborsare m730:AddComRimborsare m730:CedolareRimborsare

element **Importi_Rimborsare_730-4_Type/IrpefRimborsare**

diagram	
namespace	urn:www.agenziaentrate.gov.it:specificheTecniche:sco:730
type	m730:Importo_730-4
children	m730:ImportoDichiarante m730:ImportoConiuge m730:ImportoTotale

element **Importi_Rimborsare_730-4_Type/AddComRimborsare/ImportoAddizionale**

diagram	
namespace	urn:www.agenziaentrate.gov.it:specificheTecniche:sco:730
type	m730:Importo_730-4
children	m730:ImportoDichiarante m730:ImportoConiuge m730:ImportoTotale

element **Importi_Rimborsare_730-4_Type/AddComRimborsare/CodiceComuneDichiarante**

diagram					
namespace	urn:www.agenziaentrate.gov.it:specificheTecniche:sco:730				
type	DatoAN_Type				
facets	<table border="1"> <thead> <tr> <th>Kind</th> <th>Value</th> </tr> </thead> <tbody> <tr> <td>pattern</td> <td>(([0-9A-Z-]*)&quot;){1}([0-9A-Z&amp;:] ' - \., / ^*\(\ \)\ À É Ê Ì Ò Ù Û &quot; \ \\ \ +)*</td> </tr> </tbody> </table>	Kind	Value	pattern	(([0-9A-Z-]*)"){1}([0-9A-Z&:] ' - \., / ^*\(\ \)\ À É Ê Ì Ò Ù Û " \ \\ \ +)*
Kind	Value				
pattern	(([0-9A-Z-]*)"){1}([0-9A-Z&:] ' - \., / ^*\(\ \)\ À É Ê Ì Ò Ù Û " \ \\ \ +)*				

element **Importi_Rimborsare_730-4_Type/AddComRimborsare/CodiceComuneConiuge**

diagram					
namespace	urn:www.agenziaentrate.gov.it:specificheTecniche:sco:730				
type	DatoAN_Type				
facets	<table border="1"> <thead> <tr> <th>Kind</th> <th>Value</th> </tr> </thead> <tbody> <tr> <td>pattern</td> <td>(([0-9A-Z-]*)&quot;){1}([0-9A-Z&amp;:] ' - \., / ^*\(\ \)\ À É Ê Ì Ò Ù Û &quot; \ \\ \ +)*</td> </tr> </tbody> </table>	Kind	Value	pattern	(([0-9A-Z-]*)"){1}([0-9A-Z&:] ' - \., / ^*\(\ \)\ À É Ê Ì Ò Ù Û " \ \\ \ +)*
Kind	Value				
pattern	(([0-9A-Z-]*)"){1}([0-9A-Z&:] ' - \., / ^*\(\ \)\ À É Ê Ì Ò Ù Û " \ \\ \ +)*				

element **Importi_Rimborsare_730-4_Type/CedolareRimborsare**

diagram	
namespace	urn:www.agenziaentrate.gov.it:specificheTecniche:sco:730
type	m730:Importo_730-4

children	m730:ImportoDichiarante m730:ImportoConiuge m730:ImportoTotale
----------	--

complexType **Importi_Trattenere_730-4_Type**

diagram	
namespace	urn:www.agenziaentrate.gov.it:specificheTecniche:sco:730
children	m730:IrpefTrattenere m730:AddRegTrattenere m730:AddComTrattenere m730:IrpefPrimaRataTrattenere m730:IrpefSecondaRataTrattenere m730:TassSepAccontoTrattene... m730:AddComAccontoTrattene... m730:CedolareTrattenere m730:CedolarePrimaRataTratte... m730:CedolareSecondaRataTra... m730:ContribSolidTrattenere

element **Importi_Trattenere_730-4_Type/IrpefTrattenere**

diagram	
namespace	urn:www.agenziaentrate.gov.it:specificheTecniche:sco:730
type	m730:Importo_730-4
children	m730:ImportoDichiarante m730:ImportoConiuge m730:ImportoTotale

element **Importi_Trattenere_730-4_Type/AddRegTrattenere**

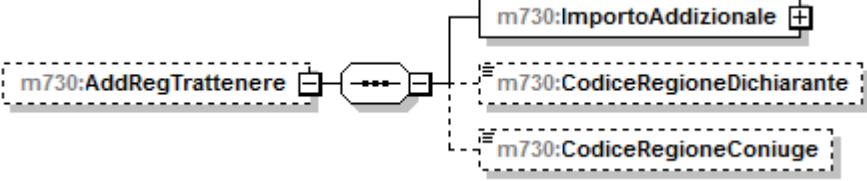
diagram	
namespace	urn:www.agenziaentrate.gov.it:specificheTecniche:sco:730
children	m730:ImportoAddizionale m730:CodiceRegioneDichiarante m730:CodiceRegioneConiuge

element **Importi_Trattenere_730-4_Type/AddRegTrattenere/ImportoAddizionale**

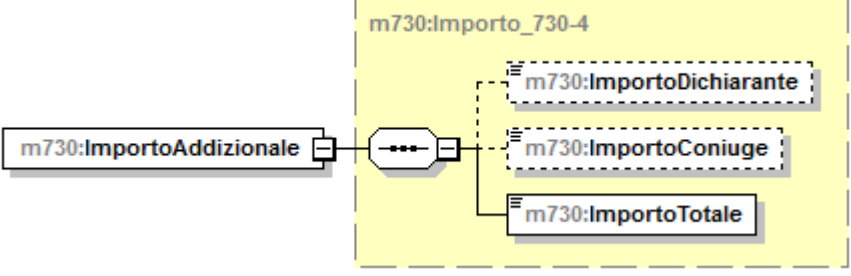
diagram	
namespace	urn:www.agenziaentrate.gov.it:specificheTecniche:sco:730
type	m730:Importo_730-4
children	m730:ImportoDichiarante m730:ImportoConiuge m730:ImportoTotale

element **Importi_Trattenere_730-4_Type/AddRegTrattenere/CodiceRegioneDichiarante**

diagram																																					
namespace	urn:www.agenziaentrate.gov.it:specificheTecniche:sco:730																																				
type	Codice Regione Type																																				
facets	<table border="1"> <thead> <tr> <th>Kind</th> <th>Value</th> </tr> </thead> <tbody> <tr> <td>pattern</td> <td>([0-9A-Z-] &quot;){1}([0-9A-Z&amp;] ' \\-\\. , /° \\^\\(\\)À Ê É Ï Ò Ù Û &quot; \\N \\+)*</td> </tr> <tr> <td>enumeration</td> <td>1</td> </tr> <tr> <td>enumeration</td> <td>2</td> </tr> <tr> <td>enumeration</td> <td>3</td> </tr> <tr> <td>enumeration</td> <td>4</td> </tr> <tr> <td>enumeration</td> <td>5</td> </tr> <tr> <td>enumeration</td> <td>6</td> </tr> <tr> <td>enumeration</td> <td>7</td> </tr> <tr> <td>enumeration</td> <td>8</td> </tr> <tr> <td>enumeration</td> <td>9</td> </tr> <tr> <td>enumeration</td> <td>10</td> </tr> <tr> <td>enumeration</td> <td>11</td> </tr> <tr> <td>enumeration</td> <td>12</td> </tr> <tr> <td>enumeration</td> <td>13</td> </tr> <tr> <td>enumeration</td> <td>14</td> </tr> <tr> <td>enumeration</td> <td>15</td> </tr> <tr> <td>enumeration</td> <td>16</td> </tr> </tbody> </table>	Kind	Value	pattern	([0-9A-Z-] "){1}([0-9A-Z&] ' \\-\\. , /° \\^\\(\\)À Ê É Ï Ò Ù Û " \\N \\+)*	enumeration	1	enumeration	2	enumeration	3	enumeration	4	enumeration	5	enumeration	6	enumeration	7	enumeration	8	enumeration	9	enumeration	10	enumeration	11	enumeration	12	enumeration	13	enumeration	14	enumeration	15	enumeration	16
Kind	Value																																				
pattern	([0-9A-Z-] "){1}([0-9A-Z&] ' \\-\\. , /° \\^\\(\\)À Ê É Ï Ò Ù Û " \\N \\+)*																																				
enumeration	1																																				
enumeration	2																																				
enumeration	3																																				
enumeration	4																																				
enumeration	5																																				
enumeration	6																																				
enumeration	7																																				
enumeration	8																																				
enumeration	9																																				
enumeration	10																																				
enumeration	11																																				
enumeration	12																																				
enumeration	13																																				
enumeration	14																																				
enumeration	15																																				
enumeration	16																																				

	enumeration 17
	enumeration 18
	enumeration 19
	enumeration 20
	enumeration 21

element **Importi_Trattenere_730-4_Type/AddRegTrattenere/CodiceRegioneConiuge**

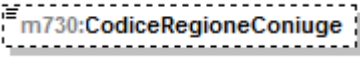
diagram																																															
namespace	urn:www.agenziaentrate.gov.it:specificheTecniche:sco:730																																														
type	Codice Regione Type																																														
facets	<table border="0"> <tr> <td>Kind</td> <td>Value</td> </tr> <tr> <td>pattern</td> <td>([0-9A-Z\-\-])&quot;){1}([0-9A-Z&amp;:] '\-\. , / ° °\°\(\) À È É Ì Ò Ù Û &quot; \N \+)*</td> </tr> <tr><td>enumeration 1</td><td></td></tr> <tr><td>enumeration 2</td><td></td></tr> <tr><td>enumeration 3</td><td></td></tr> <tr><td>enumeration 4</td><td></td></tr> <tr><td>enumeration 5</td><td></td></tr> <tr><td>enumeration 6</td><td></td></tr> <tr><td>enumeration 7</td><td></td></tr> <tr><td>enumeration 8</td><td></td></tr> <tr><td>enumeration 9</td><td></td></tr> <tr><td>enumeration 10</td><td></td></tr> <tr><td>enumeration 11</td><td></td></tr> <tr><td>enumeration 12</td><td></td></tr> <tr><td>enumeration 13</td><td></td></tr> <tr><td>enumeration 14</td><td></td></tr> <tr><td>enumeration 15</td><td></td></tr> <tr><td>enumeration 16</td><td></td></tr> <tr><td>enumeration 17</td><td></td></tr> <tr><td>enumeration 18</td><td></td></tr> <tr><td>enumeration 19</td><td></td></tr> <tr><td>enumeration 20</td><td></td></tr> <tr><td>enumeration 21</td><td></td></tr> </table>	Kind	Value	pattern	([0-9A-Z\-\-])"){1}([0-9A-Z&:] '\-\. , / ° °\°\(\) À È É Ì Ò Ù Û " \N \+)*	enumeration 1		enumeration 2		enumeration 3		enumeration 4		enumeration 5		enumeration 6		enumeration 7		enumeration 8		enumeration 9		enumeration 10		enumeration 11		enumeration 12		enumeration 13		enumeration 14		enumeration 15		enumeration 16		enumeration 17		enumeration 18		enumeration 19		enumeration 20		enumeration 21	
Kind	Value																																														
pattern	([0-9A-Z\-\-])"){1}([0-9A-Z&:] '\-\. , / ° °\°\(\) À È É Ì Ò Ù Û " \N \+)*																																														
enumeration 1																																															
enumeration 2																																															
enumeration 3																																															
enumeration 4																																															
enumeration 5																																															
enumeration 6																																															
enumeration 7																																															
enumeration 8																																															
enumeration 9																																															
enumeration 10																																															
enumeration 11																																															
enumeration 12																																															
enumeration 13																																															
enumeration 14																																															
enumeration 15																																															
enumeration 16																																															
enumeration 17																																															
enumeration 18																																															
enumeration 19																																															
enumeration 20																																															
enumeration 21																																															

element **Importi_Trattenere_730-4_Type/AddComTrattenere**

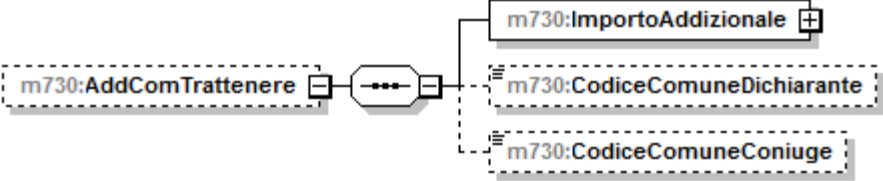
diagram	
namespace	urn:www.agenziaentrate.gov.it:specificheTecniche:sco:730
children	m730:ImportoAddizionale m730:CodiceComuneDichiarante m730:CodiceComuneConiuge

element **Importi_Trattenere_730-4_Type/AddComTrattenere/ImportoAddizionale**

diagram	
namespace	urn:www.agenziaentrate.gov.it:specificheTecniche:sco:730
type	m730:Importo_730-4
children	m730:ImportoDichiarante m730:ImportoConiuge m730:ImportoTotale

element **Importi_Trattenere_730-4_Type/AddComTrattenere/CodiceComuneDichiarante**

diagram					
namespace	urn:www.agenziaentrate.gov.it:specificheTecniche:sco:730				
type	DatoAN_Type				
facets	<table border="1"> <thead> <tr> <th>Kind</th> <th>Value</th> </tr> </thead> <tbody> <tr> <td>pattern</td> <td>(([0-9A-Z-]*)&quot;){1}([0-9A-Z&amp;:] ' - \., / ^*\(\) \) À É Ê Ì Ò Ù Û &quot;; \\ / +)*</td> </tr> </tbody> </table>	Kind	Value	pattern	(([0-9A-Z-]*)"){1}([0-9A-Z&:] ' - \., / ^*\(\) \) À É Ê Ì Ò Ù Û "; \\ / +)*
Kind	Value				
pattern	(([0-9A-Z-]*)"){1}([0-9A-Z&:] ' - \., / ^*\(\) \) À É Ê Ì Ò Ù Û "; \\ / +)*				

element **Importi_Trattenere_730-4_Type/AddComTrattenere/CodiceComuneConiuge**

diagram					
namespace	urn:www.agenziaentrate.gov.it:specificheTecniche:sco:730				
type	DatoAN_Type				
facets	<table border="1"> <thead> <tr> <th>Kind</th> <th>Value</th> </tr> </thead> <tbody> <tr> <td>pattern</td> <td>(([0-9A-Z-]*)&quot;){1}([0-9A-Z&amp;:] ' - \., / ^*\(\) \) À É Ê Ì Ò Ù Û &quot;; \\ / +)*</td> </tr> </tbody> </table>	Kind	Value	pattern	(([0-9A-Z-]*)"){1}([0-9A-Z&:] ' - \., / ^*\(\) \) À É Ê Ì Ò Ù Û "; \\ / +)*
Kind	Value				
pattern	(([0-9A-Z-]*)"){1}([0-9A-Z&:] ' - \., / ^*\(\) \) À É Ê Ì Ò Ù Û "; \\ / +)*				

element **Importi_Trattenere_730-4_Type/IrpefPrimaRataTrattenere**

diagram	
namespace	urn:www.agenziaentrate.gov.it:specificheTecniche:sco:730
type	m730:Importo_730-4

children	m730:ImportoDichiarante m730:ImportoConiuge m730:ImportoTotale
----------	--

element **Importi_Trattenere_730-4_Type/IrpefSecondaRataTrattenere**

diagram	<p>The diagram shows a class <code>m730:IrpefSecondaRataTrattenere</code> (dashed box) connected to a container <code>m730:Importo_730-4</code> (yellow box). The container contains three elements: <code>m730:ImportoDichiarante</code> (dashed box), <code>m730:ImportoConiuge</code> (dashed box), and <code>m730:ImportoTotale</code> (solid box).</p>
namespace	urn:www.agenziaentrate.gov.it:specificheTecniche:sco:730
type	m730:Importo_730-4
children	m730:ImportoDichiarante m730:ImportoConiuge m730:ImportoTotale

element **Importi_Trattenere_730-4_Type/TassSepAccontoTrattenere**

diagram	<p>The diagram shows a class <code>m730:TassSepAccontoTrattenere</code> (dashed box) connected to a container <code>m730:Importo_730-4</code> (yellow box). The container contains three elements: <code>m730:ImportoDichiarante</code> (dashed box), <code>m730:ImportoConiuge</code> (dashed box), and <code>m730:ImportoTotale</code> (solid box).</p>
namespace	urn:www.agenziaentrate.gov.it:specificheTecniche:sco:730
type	m730:Importo_730-4
children	m730:ImportoDichiarante m730:ImportoConiuge m730:ImportoTotale

element **Importi_Trattenere_730-4_Type/AddComAccontoTrattenere**

diagram	<p>The diagram shows a class <code>m730:AddComAccontoTrattenere</code> (dashed box) connected to a container <code>m730:Importo_730-4</code> (yellow box). The container contains three elements: <code>m730:ImportoAddizionale</code> (solid box), <code>m730:CodiceComuneDichiarante</code> (dashed box), and <code>m730:CodiceComuneConiuge</code> (dashed box).</p>
namespace	urn:www.agenziaentrate.gov.it:specificheTecniche:sco:730
children	m730:ImportoAddizionale m730:CodiceComuneDichiarante m730:CodiceComuneConiuge

element **Importi_Trattenere_730-4_Type/AddComAccontoTrattenere/ImportoAddizionale**

diagram	
namespace	urn:www.agenziaentrate.gov.it:specificheTecniche:sco:730
type	m730:Importo_730-4
children	m730:ImportoDichiarante m730:ImportoConiuge m730:ImportoTotale

element **Importi_Trattenere_730-4_Type/AddComAccontoTrattenere/CodiceComuneDichiarante**

diagram					
namespace	urn:www.agenziaentrate.gov.it:specificheTecniche:sco:730				
type	DatoAN_Type				
facets	<table border="1"> <thead> <tr> <th>Kind</th> <th>Value</th> </tr> </thead> <tbody> <tr> <td>pattern</td> <td>(([0-9A-Z-]*)&quot;){1}([0-9A-Z&amp;:] ' - \., / ° ^\(\\)\) À É È Ì Ò Ù Ü &quot;; \\ / +)*</td> </tr> </tbody> </table>	Kind	Value	pattern	(([0-9A-Z-]*)"){1}([0-9A-Z&:] ' - \., / ° ^\(\\)\) À É È Ì Ò Ù Ü "; \\ / +)*
Kind	Value				
pattern	(([0-9A-Z-]*)"){1}([0-9A-Z&:] ' - \., / ° ^\(\\)\) À É È Ì Ò Ù Ü "; \\ / +)*				

element **Importi_Trattenere_730-4_Type/AddComAccontoTrattenere/CodiceComuneConiuge**

diagram					
namespace	urn:www.agenziaentrate.gov.it:specificheTecniche:sco:730				
type	DatoAN_Type				
facets	<table border="1"> <thead> <tr> <th>Kind</th> <th>Value</th> </tr> </thead> <tbody> <tr> <td>pattern</td> <td>(([0-9A-Z-]*)&quot;){1}([0-9A-Z&amp;:] ' - \., / ° ^\(\\)\) À É È Ì Ò Ù Ü &quot;; \\ / +)*</td> </tr> </tbody> </table>	Kind	Value	pattern	(([0-9A-Z-]*)"){1}([0-9A-Z&:] ' - \., / ° ^\(\\)\) À É È Ì Ò Ù Ü "; \\ / +)*
Kind	Value				
pattern	(([0-9A-Z-]*)"){1}([0-9A-Z&:] ' - \., / ° ^\(\\)\) À É È Ì Ò Ù Ü "; \\ / +)*				

element **Importi_Trattenere_730-4_Type/CedolareTrattenere**

diagram	
namespace	urn:www.agenziaentrate.gov.it:specificheTecniche:sco:730
type	m730:Importo_730-4

children	m730:ImportoDichiarante m730:ImportoConiuge m730:ImportoTotale
----------	--

element **Importi_Trattenere_730-4_Type/CedolarePrimaRataTrattenere**

diagram	
namespace	urn:www.agenziaentrate.gov.it:specificheTecniche:sco:730
type	m730:Importo_730-4
children	m730:ImportoDichiarante m730:ImportoConiuge m730:ImportoTotale

element **Importi_Trattenere_730-4_Type/CedolareSecondaRataTrattenere**

diagram	
namespace	urn:www.agenziaentrate.gov.it:specificheTecniche:sco:730
type	m730:Importo_730-4
children	m730:ImportoDichiarante m730:ImportoConiuge m730:ImportoTotale

element **Importi_Trattenere_730-4_Type/ContribSolidTrattenere**

diagram	
namespace	urn:www.agenziaentrate.gov.it:specificheTecniche:sco:730
type	m730:Importo_730-4

children	m730:ImportoDichiarante m730:ImportoConiuge m730:ImportoTotale
----------	--

complexType **Importo_730-4**

diagram	
namespace	urn:www.agenziaentrate.gov.it:specificheTecniche:sco:730
children	m730:ImportoDichiarante m730:ImportoConiuge m730:ImportoTotale

element **Importo_730-4/ImportoDichiarante**

diagram					
namespace	urn:www.agenziaentrate.gov.it:specificheTecniche:sco:730				
type	DatoNP_Type				
facets	<table border="1"> <thead> <tr> <th>Kind</th> <th>Value</th> </tr> </thead> <tbody> <tr> <td>pattern</td> <td>[1-9]{1}[0-9]*</td> </tr> </tbody> </table>	Kind	Value	pattern	[1-9]{1}[0-9]*
Kind	Value				
pattern	[1-9]{1}[0-9]*				

element **Importo_730-4/ImportoConiuge**

diagram					
namespace	urn:www.agenziaentrate.gov.it:specificheTecniche:sco:730				
type	DatoNP_Type				
facets	<table border="1"> <thead> <tr> <th>Kind</th> <th>Value</th> </tr> </thead> <tbody> <tr> <td>pattern</td> <td>[1-9]{1}[0-9]*</td> </tr> </tbody> </table>	Kind	Value	pattern	[1-9]{1}[0-9]*
Kind	Value				
pattern	[1-9]{1}[0-9]*				

element **Importo_730-4/ImportoTotale**

diagram					
namespace	urn:www.agenziaentrate.gov.it:specificheTecniche:sco:730				
type	DatoNP_Type				
facets	<table border="1"> <thead> <tr> <th>Kind</th> <th>Value</th> </tr> </thead> <tbody> <tr> <td>pattern</td> <td>[1-9]{1}[0-9]*</td> </tr> </tbody> </table>	Kind	Value	pattern	[1-9]{1}[0-9]*
Kind	Value				
pattern	[1-9]{1}[0-9]*				

complexType Imposta_Lorda_Type

diagram	
namespace	urn:www.agenziaentrate.gov.it:specificheTecniche:sco:730
children	m730:RedditoComplessivo m730:DeduzioneAbitazPrincipale m730:OneriDeducibili m730:RedditoImponibile m730:CompensiAttSport m730:ImportoImpostaLorda

element Imposta_Lorda_Type/RedditoComplessivo

diagram					
namespace	urn:www.agenziaentrate.gov.it:specificheTecniche:sco:730				
type	DatoNP_Type				
facets	<table border="1"> <tr> <td>Kind</td> <td>Value</td> </tr> <tr> <td>pattern</td> <td>[1-9]{1}[0-9]*</td> </tr> </table>	Kind	Value	pattern	[1-9]{1}[0-9]*
Kind	Value				
pattern	[1-9]{1}[0-9]*				

element Imposta_Lorda_Type/DeduzioneAbitazPrincipale

diagram					
namespace	urn:www.agenziaentrate.gov.it:specificheTecniche:sco:730				
type	DatoNP_Type				
facets	<table border="1"> <tr> <td>Kind</td> <td>Value</td> </tr> <tr> <td>pattern</td> <td>[1-9]{1}[0-9]*</td> </tr> </table>	Kind	Value	pattern	[1-9]{1}[0-9]*
Kind	Value				
pattern	[1-9]{1}[0-9]*				

element Imposta_Lorda_Type/OneriDeducibili

diagram					
namespace	urn:www.agenziaentrate.gov.it:specificheTecniche:sco:730				
type	DatoNP_Type				
facets	<table border="1"> <tr> <td>Kind</td> <td>Value</td> </tr> <tr> <td>pattern</td> <td>[1-9]{1}[0-9]*</td> </tr> </table>	Kind	Value	pattern	[1-9]{1}[0-9]*
Kind	Value				
pattern	[1-9]{1}[0-9]*				

element **Imposta_Lorda_Type/Redditolmponibile**

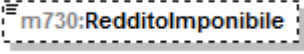
diagram	
namespace	urn:www.agenziaentrate.gov.it:specificheTecniche:sco:730
type	DatoNP_Type
facets	Kind Value pattern [1-9]{1}[0-9]*

element **Imposta_Lorda_Type/CompensiAttSport**

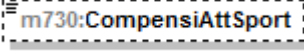
diagram	
namespace	urn:www.agenziaentrate.gov.it:specificheTecniche:sco:730
type	DatoNP_Type
facets	Kind Value pattern [1-9]{1}[0-9]*

element **Imposta_Lorda_Type/ImportolmpostaLorda**

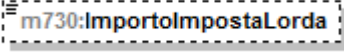
diagram	
namespace	urn:www.agenziaentrate.gov.it:specificheTecniche:sco:730
type	DatoNP_Type
facets	Kind Value pattern [1-9]{1}[0-9]*

complexType **Imposta_Netta_Type**

<p>diagram</p>	
<p>namespace</p>	<p>urn:www.agenziaentrate.gov.it:specificheTecniche:sco:730</p>
<p>children</p>	<p>m730:ImportoImpostaNetta m730:CredAltriSisma m730:CredAbitazSisma m730:CredImpEstere m730:CredErogCultura m730:CredCanNonPerc m730:CredDetrazIncapienti m730:Ritenute m730:Differenza m730:Eccedenzalrpef m730:AccontiVersati m730:RestituzioneBonus m730:CredRimborsatiSost m730:BonuslrpefSpettante m730:BonuslrpefRiconosciuto m730:RestituzioneBonuslrpef</p>

element **Imposta_Netta_Type/ImportoImpostaNetta**

<p>diagram</p>					
<p>namespace</p>	<p>urn:www.agenziaentrate.gov.it:specificheTecniche:sco:730</p>				
<p>type</p>	<p>DatoNP_Type</p>				
<p>facets</p>	<table border="1"> <tr> <td>Kind</td> <td>Value</td> </tr> <tr> <td>pattern</td> <td>[1-9]{1}[0-9]*</td> </tr> </table>	Kind	Value	pattern	[1-9]{1}[0-9]*
Kind	Value				
pattern	[1-9]{1}[0-9]*				

element Imposta_Netta_Type/CredAltriSisma

diagram	 m730:CredAltriSisma				
namespace	urn:www.agenziaentrate.gov.it:specificheTecniche:sco:730				
type	DatoNP_Type				
facets	<table border="1"> <tr> <td>Kind</td> <td>Value</td> </tr> <tr> <td>pattern</td> <td>[1-9]{1}[0-9]*</td> </tr> </table>	Kind	Value	pattern	[1-9]{1}[0-9]*
Kind	Value				
pattern	[1-9]{1}[0-9]*				

element Imposta_Netta_Type/CredAbitazSisma

diagram	 m730:CredAbitazSisma				
namespace	urn:www.agenziaentrate.gov.it:specificheTecniche:sco:730				
type	DatoNP_Type				
facets	<table border="1"> <tr> <td>Kind</td> <td>Value</td> </tr> <tr> <td>pattern</td> <td>[1-9]{1}[0-9]*</td> </tr> </table>	Kind	Value	pattern	[1-9]{1}[0-9]*
Kind	Value				
pattern	[1-9]{1}[0-9]*				

element Imposta_Netta_Type/CredImpEstere

diagram	 m730:CredImpEstere				
namespace	urn:www.agenziaentrate.gov.it:specificheTecniche:sco:730				
type	DatoNP_Type				
facets	<table border="1"> <tr> <td>Kind</td> <td>Value</td> </tr> <tr> <td>pattern</td> <td>[1-9]{1}[0-9]*</td> </tr> </table>	Kind	Value	pattern	[1-9]{1}[0-9]*
Kind	Value				
pattern	[1-9]{1}[0-9]*				

element Imposta_Netta_Type/CredErogCultura

diagram	 m730:CredErogCultura				
namespace	urn:www.agenziaentrate.gov.it:specificheTecniche:sco:730				
type	DatoNP_Type				
facets	<table border="1"> <tr> <td>Kind</td> <td>Value</td> </tr> <tr> <td>pattern</td> <td>[1-9]{1}[0-9]*</td> </tr> </table>	Kind	Value	pattern	[1-9]{1}[0-9]*
Kind	Value				
pattern	[1-9]{1}[0-9]*				

element Imposta_Netta_Type/CredCanNonPerc

diagram	 m730:CredCanNonPerc				
namespace	urn:www.agenziaentrate.gov.it:specificheTecniche:sco:730				
type	DatoNP_Type				
facets	<table border="1"> <tr> <td>Kind</td> <td>Value</td> </tr> <tr> <td>pattern</td> <td>[1-9]{1}[0-9]*</td> </tr> </table>	Kind	Value	pattern	[1-9]{1}[0-9]*
Kind	Value				
pattern	[1-9]{1}[0-9]*				

element Imposta_Netta_Type/CredDetrazIncapienti

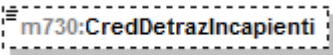
diagram					
namespace	urn:www.agenziaentrate.gov.it:specificheTecniche:sco:730				
type	DatoNP_Type				
facets	<table border="1"> <tr> <td>Kind</td> <td>Value</td> </tr> <tr> <td>pattern</td> <td>[1-9]{1}[0-9]*</td> </tr> </table>	Kind	Value	pattern	[1-9]{1}[0-9]*
Kind	Value				
pattern	[1-9]{1}[0-9]*				

element Imposta_Netta_Type/Ritenute

diagram					
namespace	urn:www.agenziaentrate.gov.it:specificheTecniche:sco:730				
type	DatoNP_Type				
facets	<table border="1"> <tr> <td>Kind</td> <td>Value</td> </tr> <tr> <td>pattern</td> <td>[1-9]{1}[0-9]*</td> </tr> </table>	Kind	Value	pattern	[1-9]{1}[0-9]*
Kind	Value				
pattern	[1-9]{1}[0-9]*				

element Imposta_Netta_Type/Differenza

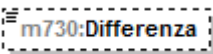
diagram					
namespace	urn:www.agenziaentrate.gov.it:specificheTecniche:sco:730				
type	DatoNU_Type				
facets	<table border="1"> <tr> <td>Kind</td> <td>Value</td> </tr> <tr> <td>pattern</td> <td>(\-[1-9] [1-9])[0-9]*</td> </tr> </table>	Kind	Value	pattern	(\-[1-9] [1-9])[0-9]*
Kind	Value				
pattern	(\-[1-9] [1-9])[0-9]*				

element Imposta_Netta_Type/Eccedenzalrpef

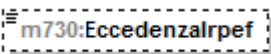
diagram					
namespace	urn:www.agenziaentrate.gov.it:specificheTecniche:sco:730				
type	DatoNU_Type				
facets	<table border="1"> <tr> <td>Kind</td> <td>Value</td> </tr> <tr> <td>pattern</td> <td>(\-[1-9] [1-9])[0-9]*</td> </tr> </table>	Kind	Value	pattern	(\-[1-9] [1-9])[0-9]*
Kind	Value				
pattern	(\-[1-9] [1-9])[0-9]*				

element Imposta_Netta_Type/AccontiVersati

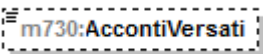
diagram	
namespace	urn:www.agenziaentrate.gov.it:specificheTecniche:sco:730
type	DatoNP_Type

facets	Kind pattern	Value [1-9]{1}[0-9]*
--------	-----------------	-------------------------

element **Imposta_Netta_Type/RestituzioneBonus**

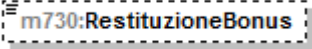
diagram		
namespace	urn:www.agenziaentrate.gov.it:specificheTecniche:sco:730	
type	DatoNP_Type	
facets	Kind pattern	Value [1-9]{1}[0-9]*

element **Imposta_Netta_Type/CredRimborsatiSost**

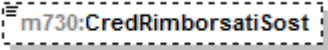
diagram		
namespace	urn:www.agenziaentrate.gov.it:specificheTecniche:sco:730	
type	DatoNP_Type	
facets	Kind pattern	Value [1-9]{1}[0-9]*

element **Imposta_Netta_Type/BonuslrpefSpettante**

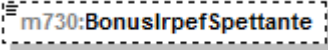
diagram		
namespace	urn:www.agenziaentrate.gov.it:specificheTecniche:sco:730	
type	DatoNP_Type	
facets	Kind pattern	Value [1-9]{1}[0-9]*

element **Imposta_Netta_Type/BonuslrpefRiconosciuto**

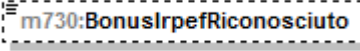
diagram		
namespace	urn:www.agenziaentrate.gov.it:specificheTecniche:sco:730	
type	DatoNP_Type	
facets	Kind pattern	Value [1-9]{1}[0-9]*

element **Imposta_Netta_Type/RestituzioneBonuslrpef**

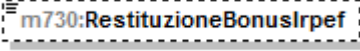
diagram		
namespace	urn:www.agenziaentrate.gov.it:specificheTecniche:sco:730	

type	DatoNP_Type
facets	Kind Value pattern [1-9]{1}[0-9]*

complexType [Imposte_Rimborsate_Type](#)

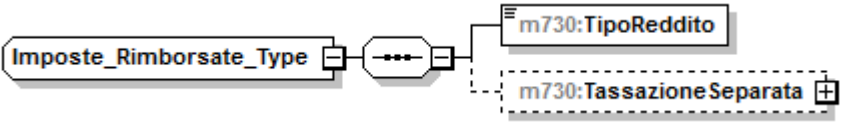
diagram	
namespace	urn:www.agenziaentrate.gov.it:specificheTecniche:sco:730
children	m730:TipoReddito m730:TassazioneSeparata

element [Imposte_Rimborsate_Type/TipoReddito](#)

diagram	
namespace	urn:www.agenziaentrate.gov.it:specificheTecniche:sco:730
type	m730:Tipo_Redito_Da1a8_Type
facets	Kind Value pattern [1-9]{1}[0-9]* enumeration 1 enumeration 2 enumeration 3 enumeration 4 enumeration 5 enumeration 6 enumeration 7 enumeration 8

element [Imposte_Rimborsate_Type/TassazioneSeparata](#)

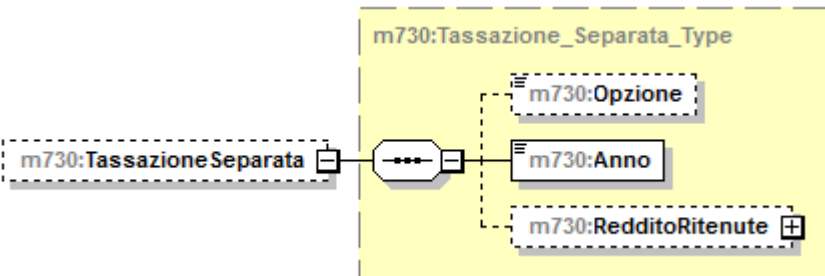
diagram	
namespace	urn:www.agenziaentrate.gov.it:specificheTecniche:sco:730
type	m730:Tassazione_Separata_Type
children	m730:Opzione m730:Anno m730:RedditoRitenute

complexType Incremento_Produttivita_Type

diagram	
namespace	urn:www.agenziaentrate.gov.it:specificheTecniche:sco:730
children	m730:ImportoTassazOrdinaria m730:ImportoImpostaSostitutiva m730:RitenuteImpostaSostitutiva m730:Art51Ordinaria m730:Art51Sostitutiva m730:TassazOrdinaria m730:TassazSostitutiva

element Incremento_Produttivita_Type/ImportoTassazOrdinaria

diagram					
namespace	urn:www.agenziaentrate.gov.it:specificheTecniche:sco:730				
type	DatoNP_Type				
facets	<table border="1"> <tr> <td>Kind</td> <td>Value</td> </tr> <tr> <td>pattern</td> <td>[1-9]{1}[0-9]*</td> </tr> </table>	Kind	Value	pattern	[1-9]{1}[0-9]*
Kind	Value				
pattern	[1-9]{1}[0-9]*				

element Incremento_Produttivita_Type/ImportoImpostaSostitutiva

diagram					
namespace	urn:www.agenziaentrate.gov.it:specificheTecniche:sco:730				
type	DatoNP_Type				
facets	<table border="1"> <tr> <td>Kind</td> <td>Value</td> </tr> <tr> <td>pattern</td> <td>[1-9]{1}[0-9]*</td> </tr> </table>	Kind	Value	pattern	[1-9]{1}[0-9]*
Kind	Value				
pattern	[1-9]{1}[0-9]*				

element Incremento_Produttivita_Type/RitenuteImpostaSostitutiva

diagram					
namespace	urn:www.agenziaentrate.gov.it:specificheTecniche:sco:730				
type	DatoNP_Type				
facets	<table border="1"> <tr> <td>Kind</td> <td>Value</td> </tr> <tr> <td>pattern</td> <td>[1-9]{1}[0-9]*</td> </tr> </table>	Kind	Value	pattern	[1-9]{1}[0-9]*
Kind	Value				
pattern	[1-9]{1}[0-9]*				

element **Incremento_Produttivita_Type/Art51Ordinaria**

diagram					
namespace	urn:www.agenziaentrate.gov.it:specificheTecniche:sco:730				
type	DatoNP_Type				
facets	<table border="1"> <tr> <td>Kind</td> <td>Value</td> </tr> <tr> <td>pattern</td> <td>[1-9]{1}[0-9]*</td> </tr> </table>	Kind	Value	pattern	[1-9]{1}[0-9]*
Kind	Value				
pattern	[1-9]{1}[0-9]*				

element **Incremento_Produttivita_Type/Art51Sostitutiva**

diagram					
namespace	urn:www.agenziaentrate.gov.it:specificheTecniche:sco:730				
type	DatoNP_Type				
facets	<table border="1"> <tr> <td>Kind</td> <td>Value</td> </tr> <tr> <td>pattern</td> <td>[1-9]{1}[0-9]*</td> </tr> </table>	Kind	Value	pattern	[1-9]{1}[0-9]*
Kind	Value				
pattern	[1-9]{1}[0-9]*				

element **Incremento_Produttivita_Type/TassazOrdinaria**

diagram					
namespace	urn:www.agenziaentrate.gov.it:specificheTecniche:sco:730				
type	DatoCB_Type				
facets	<table border="1"> <tr> <td>Kind</td> <td>Value</td> </tr> <tr> <td>pattern</td> <td>[01]</td> </tr> </table>	Kind	Value	pattern	[01]
Kind	Value				
pattern	[01]				

element **Incremento_Produttivita_Type/TassazSostitutiva**

diagram					
namespace	urn:www.agenziaentrate.gov.it:specificheTecniche:sco:730				
type	DatoCB_Type				
facets	<table border="1"> <tr> <td>Kind</td> <td>Value</td> </tr> <tr> <td>pattern</td> <td>[01]</td> </tr> </table>	Kind	Value	pattern	[01]
Kind	Value				
pattern	[01]				

complexType **Inquilini_Abitazione_Principale_Type**

diagram	
namespace	urn:www.agenziaentrate.gov.it:specificheTecniche:sco:730

children	m730:Tipologia m730:GiorniPercentuale
----------	---

element **Inquilini_Abitazione_Principale_Type/Tipologia**

diagram													
namespace	urn:www.agenziaentrate.gov.it:specificheTecniche:sco:730												
type	m730:Tipo Inquilino Type												
facets	<table border="1"> <thead> <tr> <th>Kind</th> <th>Value</th> </tr> </thead> <tbody> <tr> <td>pattern</td> <td>[1-9]{1}[0-9]*</td> </tr> <tr> <td>enumeration</td> <td>1</td> </tr> <tr> <td>enumeration</td> <td>2</td> </tr> <tr> <td>enumeration</td> <td>3</td> </tr> <tr> <td>enumeration</td> <td>4</td> </tr> </tbody> </table>	Kind	Value	pattern	[1-9]{1}[0-9]*	enumeration	1	enumeration	2	enumeration	3	enumeration	4
Kind	Value												
pattern	[1-9]{1}[0-9]*												
enumeration	1												
enumeration	2												
enumeration	3												
enumeration	4												

element **Inquilini_Abitazione_Principale_Type/GiorniPercentuale**

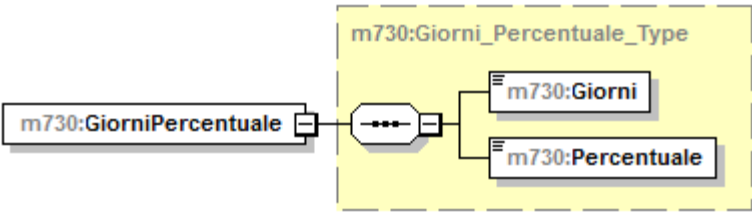
diagram	
namespace	urn:www.agenziaentrate.gov.it:specificheTecniche:sco:730
type	m730:Giorni Percentuale Type
children	m730:Giorni m730:Percentuale

complexType **Intervento_Ricupero_Patrimonio_Edificio_Type**

diagram	
namespace	urn:www.agenziaentrate.gov.it:specificheTecniche:sco:730
children	m730:Anno m730:Periodo m730:CodiceFiscale m730:CasellaInterventiParticolari m730:CodiceSituazioniParticolari m730:AnnoSituazioniParticolari m730:RideterminazioneRate m730:NRate m730:Spesa m730:NOrdineImmobile

element **Intervento_Ricupero_Patrimonio_Edificio_Type/Anno**

diagram																									
namespace	urn:www.agenziaentrate.gov.it:specificheTecniche:sco:730																								
type	m730:Anno Ricupero Patrimonio Edificio_Type																								
facets	<table border="1"> <thead> <tr> <th>Kind</th> <th>Value</th> </tr> </thead> <tbody> <tr> <td>pattern</td> <td>[1-9]{1}[0-9]*</td> </tr> <tr> <td>enumeration</td> <td>2006</td> </tr> <tr> <td>enumeration</td> <td>2007</td> </tr> <tr> <td>enumeration</td> <td>2008</td> </tr> <tr> <td>enumeration</td> <td>2009</td> </tr> <tr> <td>enumeration</td> <td>2010</td> </tr> <tr> <td>enumeration</td> <td>2011</td> </tr> <tr> <td>enumeration</td> <td>2012</td> </tr> <tr> <td>enumeration</td> <td>2013</td> </tr> <tr> <td>enumeration</td> <td>2014</td> </tr> <tr> <td>enumeration</td> <td>2015</td> </tr> </tbody> </table>	Kind	Value	pattern	[1-9]{1}[0-9]*	enumeration	2006	enumeration	2007	enumeration	2008	enumeration	2009	enumeration	2010	enumeration	2011	enumeration	2012	enumeration	2013	enumeration	2014	enumeration	2015
Kind	Value																								
pattern	[1-9]{1}[0-9]*																								
enumeration	2006																								
enumeration	2007																								
enumeration	2008																								
enumeration	2009																								
enumeration	2010																								
enumeration	2011																								
enumeration	2012																								
enumeration	2013																								
enumeration	2014																								
enumeration	2015																								

element **Intervento_Ricupero_Patrimonio_Edificio_Type/Periodo**

diagram	
namespace	urn:www.agenziaentrate.gov.it:specificheTecniche:sco:730

type	m730:Periodo Spese Ristrutturazione Type	
facets	Kind	Value
	pattern	[1-9]
	enumeration	1
	enumeration	2
	enumeration	3
	enumeration	4

element **Intervento_Ricupero_Patrimonio_Edilizio_Type/CodiceFiscale**

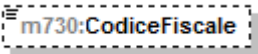
diagram		
namespace	urn:www.agenziaentrate.gov.it:specificheTecniche:sco:730	
type	DatoCF Type	
facets	Kind	Value
	pattern	[0-9]{11}[[A-Z]{6}[0-9LMNPQRSTUUV]{2}[[A-Z]{1}[0-9LMNPQRSTUUV]{2}[[A-Z]{1}[0-9LMNPQRSTUUV]{3}[[A-Z]{1}

element **Intervento_Ricupero_Patrimonio_Edilizio_Type/CasellaInterventiParticolari**

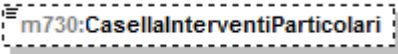
diagram		
namespace	urn:www.agenziaentrate.gov.it:specificheTecniche:sco:730	
type	restriction of DatoN1 Type	
facets	Kind	Value
	pattern	[1-9]
	enumeration	1
	enumeration	3
	enumeration	4

element **Intervento_Ricupero_Patrimonio_Edilizio_Type/CodiceSituazioniParticolari**

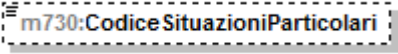
diagram		
namespace	urn:www.agenziaentrate.gov.it:specificheTecniche:sco:730	
type	m730:Casella Codice Type	
facets	Kind	Value
	pattern	[1-9]
	enumeration	1
	enumeration	4

element **Intervento_Ricupero_Patrimonio_Edilizio_Type/AnnoSituazioniParticolari**

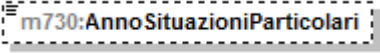
diagram		
namespace	urn:www.agenziaentrate.gov.it:specificheTecniche:sco:730	
type	m730:Anno Patrimonio Edilizio Situazioni Particolari Type	
facets	Kind	Value
	pattern	[1-9]{1}[0-9]*

	enumeration 2011
--	------------------

element Intervento_Ricupero_Patrimonio_Edilizio_Type/RideterminazioneRate

diagram							
namespace	urn:www.agenziaentrate.gov.it:specificheTecniche:sco:730						
type	m730:Rideterminazione Rate Type						
facets	<table border="1"> <tr> <td>Kind</td> <td>Value</td> </tr> <tr> <td>pattern</td> <td>[1-9]{1}[0-9]*</td> </tr> <tr> <td>enumeration</td> <td>10</td> </tr> </table>	Kind	Value	pattern	[1-9]{1}[0-9]*	enumeration	10
Kind	Value						
pattern	[1-9]{1}[0-9]*						
enumeration	10						

element Intervento_Ricupero_Patrimonio_Edilizio_Type/NRate

diagram	
namespace	urn:www.agenziaentrate.gov.it:specificheTecniche:sco:730
type	m730:N Rate Type
children	m730:Rate5 m730:Rate10

element Intervento_Ricupero_Patrimonio_Edilizio_Type/Spesa

diagram					
namespace	urn:www.agenziaentrate.gov.it:specificheTecniche:sco:730				
type	DatoNP Type				
facets	<table border="1"> <tr> <td>Kind</td> <td>Value</td> </tr> <tr> <td>pattern</td> <td>[1-9]{1}[0-9]*</td> </tr> </table>	Kind	Value	pattern	[1-9]{1}[0-9]*
Kind	Value				
pattern	[1-9]{1}[0-9]*				

element Intervento_Ricupero_Patrimonio_Edilizio_Type/NOrdineImmobile

diagram					
namespace	urn:www.agenziaentrate.gov.it:specificheTecniche:sco:730				
type	DatoNP Type				
facets	<table border="1"> <tr> <td>Kind</td> <td>Value</td> </tr> <tr> <td>pattern</td> <td>[1-9]{1}[0-9]*</td> </tr> </table>	Kind	Value	pattern	[1-9]{1}[0-9]*
Kind	Value				
pattern	[1-9]{1}[0-9]*				

complexType Intervento_Risparmio_Energetico_Type

diagram	
namespace	urn:www.agenziaentrate.gov.it:specificheTecniche:sco:730
children	m730:TipIntervento m730:Anno m730:Periodo2013 m730:CasiParticolari m730:RideterminazioneRate m730:RipartizioneRate m730:NumeroRata m730:Spesa

element Intervento_Risparmio_Energetico_Type/TipIntervento

diagram																	
namespace	urn:www.agenziaentrate.gov.it:specificheTecniche:sco:730																
type	m730:Tipo_Intervento_Type																
facets	<table border="1"> <thead> <tr> <th>Kind</th> <th>Value</th> </tr> </thead> <tbody> <tr> <td>pattern</td> <td>[1-9]</td> </tr> <tr> <td>enumeration</td> <td>1</td> </tr> <tr> <td>enumeration</td> <td>2</td> </tr> <tr> <td>enumeration</td> <td>3</td> </tr> <tr> <td>enumeration</td> <td>4</td> </tr> <tr> <td>enumeration</td> <td>5</td> </tr> <tr> <td>enumeration</td> <td>6</td> </tr> </tbody> </table>	Kind	Value	pattern	[1-9]	enumeration	1	enumeration	2	enumeration	3	enumeration	4	enumeration	5	enumeration	6
Kind	Value																
pattern	[1-9]																
enumeration	1																
enumeration	2																
enumeration	3																
enumeration	4																
enumeration	5																
enumeration	6																

element Intervento_Risparmio_Energetico_Type/Anno

diagram																	
namespace	urn:www.agenziaentrate.gov.it:specificheTecniche:sco:730																
type	m730:Anno_Risparmio_Energetico_Type																
facets	<table border="1"> <thead> <tr> <th>Kind</th> <th>Value</th> </tr> </thead> <tbody> <tr> <td>pattern</td> <td>[1-9]{1}[0-9]*</td> </tr> <tr> <td>enumeration</td> <td>2008</td> </tr> <tr> <td>enumeration</td> <td>2010</td> </tr> <tr> <td>enumeration</td> <td>2011</td> </tr> <tr> <td>enumeration</td> <td>2012</td> </tr> <tr> <td>enumeration</td> <td>2013</td> </tr> <tr> <td>enumeration</td> <td>2014</td> </tr> </tbody> </table>	Kind	Value	pattern	[1-9]{1}[0-9]*	enumeration	2008	enumeration	2010	enumeration	2011	enumeration	2012	enumeration	2013	enumeration	2014
Kind	Value																
pattern	[1-9]{1}[0-9]*																
enumeration	2008																
enumeration	2010																
enumeration	2011																
enumeration	2012																
enumeration	2013																
enumeration	2014																

	enumeration 2015
--	------------------

element Intervento_Risparmio_Energetico_Type/Periodo2013

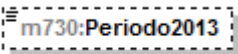
diagram									
namespace	urn:www.agenziaentrate.gov.it:specificheTecniche:sco:730								
type	restriction of DatoN1_Type								
facets	<table border="0"> <tr> <td>Kind</td> <td>Value</td> </tr> <tr> <td>pattern</td> <td>[1-9]</td> </tr> <tr> <td>enumeration</td> <td>1</td> </tr> <tr> <td>enumeration</td> <td>2</td> </tr> </table>	Kind	Value	pattern	[1-9]	enumeration	1	enumeration	2
Kind	Value								
pattern	[1-9]								
enumeration	1								
enumeration	2								

element Intervento_Risparmio_Energetico_Type/CasiParticolari

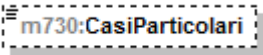
diagram											
namespace	urn:www.agenziaentrate.gov.it:specificheTecniche:sco:730										
type	m730:Casi Particolari Risp Ener Type										
facets	<table border="0"> <tr> <td>Kind</td> <td>Value</td> </tr> <tr> <td>pattern</td> <td>[1-9]</td> </tr> <tr> <td>enumeration</td> <td>1</td> </tr> <tr> <td>enumeration</td> <td>2</td> </tr> <tr> <td>enumeration</td> <td>3</td> </tr> </table>	Kind	Value	pattern	[1-9]	enumeration	1	enumeration	2	enumeration	3
Kind	Value										
pattern	[1-9]										
enumeration	1										
enumeration	2										
enumeration	3										

element Intervento_Risparmio_Energetico_Type/RideterminazioneRate

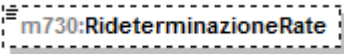
diagram																					
namespace	urn:www.agenziaentrate.gov.it:specificheTecniche:sco:730																				
type	m730:Rate Risparmio Energetico Type																				
facets	<table border="0"> <tr> <td>Kind</td> <td>Value</td> </tr> <tr> <td>pattern</td> <td>[1-9]{1}[0-9]*</td> </tr> <tr> <td>enumeration</td> <td>3</td> </tr> <tr> <td>enumeration</td> <td>4</td> </tr> <tr> <td>enumeration</td> <td>5</td> </tr> <tr> <td>enumeration</td> <td>6</td> </tr> <tr> <td>enumeration</td> <td>7</td> </tr> <tr> <td>enumeration</td> <td>8</td> </tr> <tr> <td>enumeration</td> <td>9</td> </tr> <tr> <td>enumeration</td> <td>10</td> </tr> </table>	Kind	Value	pattern	[1-9]{1}[0-9]*	enumeration	3	enumeration	4	enumeration	5	enumeration	6	enumeration	7	enumeration	8	enumeration	9	enumeration	10
Kind	Value																				
pattern	[1-9]{1}[0-9]*																				
enumeration	3																				
enumeration	4																				
enumeration	5																				
enumeration	6																				
enumeration	7																				
enumeration	8																				
enumeration	9																				
enumeration	10																				

element Intervento_Risparmio_Energetico_Type/RipartizioneRate

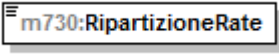
diagram			
namespace	urn:www.agenziaentrate.gov.it:specificheTecniche:sco:730		
type	m730:Ripart Risparmio Energetico Type		
facets	<table border="0"> <tr> <td>Kind</td> <td>Value</td> </tr> </table>	Kind	Value
Kind	Value		

pattern	[1-9]{1}[0-9]*
enumeration	8
enumeration	9
enumeration	10

element **Intervento_Risparmio_Energetico_Type/NumeroRata**

diagram																	
namespace	urn:www.agenziaentrate.gov.it:specificheTecniche:sco:730																
type	m730:Numero_Rata_Risparmio_Energetico_Type																
facets	<table border="1"> <thead> <tr> <th>Kind</th> <th>Value</th> </tr> </thead> <tbody> <tr> <td>pattern</td> <td>[1-9]{1}[0-9]*</td> </tr> <tr> <td>enumeration</td> <td>1</td> </tr> <tr> <td>enumeration</td> <td>2</td> </tr> <tr> <td>enumeration</td> <td>3</td> </tr> <tr> <td>enumeration</td> <td>4</td> </tr> <tr> <td>enumeration</td> <td>5</td> </tr> <tr> <td>enumeration</td> <td>8</td> </tr> </tbody> </table>	Kind	Value	pattern	[1-9]{1}[0-9]*	enumeration	1	enumeration	2	enumeration	3	enumeration	4	enumeration	5	enumeration	8
Kind	Value																
pattern	[1-9]{1}[0-9]*																
enumeration	1																
enumeration	2																
enumeration	3																
enumeration	4																
enumeration	5																
enumeration	8																

element **Intervento_Risparmio_Energetico_Type/Spesa**

diagram					
namespace	urn:www.agenziaentrate.gov.it:specificheTecniche:sco:730				
type	DatoNP_Type				
facets	<table border="1"> <thead> <tr> <th>Kind</th> <th>Value</th> </tr> </thead> <tbody> <tr> <td>pattern</td> <td>[1-9]{1}[0-9]*</td> </tr> </tbody> </table>	Kind	Value	pattern	[1-9]{1}[0-9]*
Kind	Value				
pattern	[1-9]{1}[0-9]*				

complexType **Lavoro_Dipendente_Type**

diagram	
namespace	urn:www.agenziaentrate.gov.it:specificheTecniche:sco:730
children	m730:TipologiaReddito m730:TipoContratto m730:Reddito

element **Lavoro_Dipendente_Type/TipologiaReddito**

diagram					
namespace	urn:www.agenziaentrate.gov.it:specificheTecniche:sco:730				
type	m730:Tipo_Reddito_Da1a6_Type				
facets	<table border="1"> <thead> <tr> <th>Kind</th> <th>Value</th> </tr> </thead> <tbody> <tr> <td>pattern</td> <td>[1-9]</td> </tr> </tbody> </table>	Kind	Value	pattern	[1-9]
Kind	Value				
pattern	[1-9]				

	enumeration 1
	enumeration 2
	enumeration 3
	enumeration 4
	enumeration 5
	enumeration 6

element Lavoro_Dipendente_Type/TipoContratto

diagram									
namespace	urn:www.agenziaentrate.gov.it:specificheTecniche:sco:730								
type	m730:Indeterminato_Determinato_Type								
facets	<table border="1"> <thead> <tr> <th>Kind</th> <th>Value</th> </tr> </thead> <tbody> <tr> <td>pattern</td> <td>[1-9]</td> </tr> <tr> <td>enumeration</td> <td>1</td> </tr> <tr> <td>enumeration</td> <td>2</td> </tr> </tbody> </table>	Kind	Value	pattern	[1-9]	enumeration	1	enumeration	2
Kind	Value								
pattern	[1-9]								
enumeration	1								
enumeration	2								

element Lavoro_Dipendente_Type/Reddito

diagram					
namespace	urn:www.agenziaentrate.gov.it:specificheTecniche:sco:730				
type	DatoNP_Type				
facets	<table border="1"> <thead> <tr> <th>Kind</th> <th>Value</th> </tr> </thead> <tbody> <tr> <td>pattern</td> <td>[1-9]{1}[0-9]*</td> </tr> </tbody> </table>	Kind	Value	pattern	[1-9]{1}[0-9]*
Kind	Value				
pattern	[1-9]{1}[0-9]*				

complexType Misura_Aconti_Type

diagram	
namespace	urn:www.agenziaentrate.gov.it:specificheTecniche:sco:730
children	m730:IrpefMisuralInferiore m730:AddComunaleMisuralInferiore m730:CedolareSeccaMisuralInferiore m730:NumeroRate

element **Misura_Acconti_Type/IrpefMisuralInferiore**

diagram	
namespace	urn:www.agenziaentrate.gov.it:specificheTecniche:sco:730
type	m730:Casella_Acconto_Type
children	m730:Casella m730:ImportoMisuralInferiore

element **Misura_Acconti_Type/AddComunaleMisuralInferiore**

diagram	
namespace	urn:www.agenziaentrate.gov.it:specificheTecniche:sco:730
type	m730:Casella_Acconto_Type
children	m730:Casella m730:ImportoMisuralInferiore

element **Misura_Acconti_Type/CedolareSeccaMisuralInferiore**

diagram	
namespace	urn:www.agenziaentrate.gov.it:specificheTecniche:sco:730
type	m730:Casella_Acconto_Type
children	m730:Casella m730:ImportoMisuralInferiore

element **Misura_Acconti_Type/NumeroRate**

diagram	
namespace	urn:www.agenziaentrate.gov.it:specificheTecniche:sco:730
type	restriction of DatoN1_Type

facets	Kind	Value
	pattern	[1-9]
	enumeration	2
	enumeration	3
	enumeration	4
	enumeration	5
	enumeration	6
enumeration	7	

complexType **Mod730_Integrativo_Type**

diagram	
namespace	urn:www.agenziaentrate.gov.it:specificheTecniche:sco:730
children	m730:ImportiRimborsare m730:ImportoRimborsato m730:ImportoRimborsatoAgenzia

element **Mod730_Integrativo_Type/ImportiRimborsare**

diagram	
namespace	urn:www.agenziaentrate.gov.it:specificheTecniche:sco:730
type	m730:Importi Rimborsare 730-4 Integrativo Type
children	m730:IrpefRimborsare m730:AddRegRimborsare m730:AddComRimborsare m730:CedolareRimborsare m730:TassazioneSepRimborsare m730:ContributoSolidarieta

element **Mod730_Integrativo_Type/ImportoRimborsato**

diagram	
namespace	urn:www.agenziaentrate.gov.it:specificheTecniche:sco:730
type	DatoNP_Type

facets	Kind pattern	Value [1-9]{1}[0-9]*
--------	-----------------	-------------------------

element **Mod730_Integrativo_Type/ImportoRimborsatoAgenzia**

diagram		
namespace	urn:www.agenziaentrate.gov.it:specificheTecniche:sco:730	
type	DatoNP_Type	
facets	Kind pattern	Value [1-9]{1}[0-9]*

complexType **Modulo_Altri_Reddito_Type**

diagram		
namespace	urn:www.agenziaentrate.gov.it:specificheTecniche:sco:730	
children	m730:RedditiDiCapitale m730:RedditiTassazioneSeparata	

element **Modulo_Altri_Reddito_Type/RedditiDiCapitale**

diagram		
namespace	urn:www.agenziaentrate.gov.it:specificheTecniche:sco:730	
type	m730:Redditi_Capitale_Type	
children	m730:Utili m730:AltriRedditiDiCapitale m730:LavoroAutonomo m730:RedditiDiversi m730:RedditiDiversiDetraz	

element **Modulo_Altri_Reddi_Type/RedditiTassazioneSeparata**

diagram	
namespace	urn:www.agenziaentrate.gov.it:specificheTecniche:sco:730
type	m730:Redditi_Tassazione_Separata_Type
children	m730:RedditiErede m730:ImposteRimborsate

complexType **Modulo_Annotazioni_Type**

diagram	
namespace	urn:www.agenziaentrate.gov.it:specificheTecniche:sco:730
children	m730:Annotazione

element **Modulo_Annotazioni_Type/Annotazione**

diagram	
namespace	urn:www.agenziaentrate.gov.it:specificheTecniche:sco:730
type	m730:Annotazione_Type
children	m730:Codice m730:RigoQuadro m730:ModuloQuadro m730:Importo

complexType **Modulo_Comunicazione_Type**

diagram	
namespace	urn:www.agenziaentrate.gov.it:specificheTecniche:sco:730
children	m730:DatiCondominio m730:DatiCatastali m730:DomandaAccatastamento m730:DatiFornitore

element **Modulo_Comunicazione_Type/DatiCondominio**

diagram	
namespace	urn:www.agenziaentrate.gov.it:specificheTecniche:sco:730
type	m730:Dati_Condominio_Type
children	m730:CodiceFiscale m730:Denominazione

element **Modulo_Comunicazione_Type/DatiCatastali**

diagram	
namespace	urn:www.agenziaentrate.gov.it:specificheTecniche:sco:730
type	m730:Dati_Catastali_Type

children	m730:CodiceComune m730:TerreniUrbano m730:SezioneUrbanaComuneCatastale m730:Foglio m730:Particella m730:Subalterno
----------	--

element **Modulo_Communicazione_Type/DomandaAccatastamento**

diagram	
namespace	urn:www.agenziaentrate.gov.it:specificheTecniche:sco:730
type	m730:Domanda_Accatastamento_Type
children	m730:Data m730:Numero m730:ProvinciaUfficio

element **Modulo_Communicazione_Type/DatiFornitore**

diagram	
namespace	urn:www.agenziaentrate.gov.it:specificheTecniche:sco:730
type	m730:Dati_Fornitore_Type
children	m730:CodiceFiscale m730:CognomeDenom m730:Nome m730:Sesso m730:DataNascita m730:ComuneNascita m730:ProvinciaNascita m730:ImportoAcquisti

complexType **Modulo_Crediti_Imposta_Type**

diagram	
namespace	urn:www.agenziaentrate.gov.it:specificheTecniche:sco:730
children	m730:CreditoImpostaFondiPensione m730:CreditoImpostaRedditiEsteri m730:CreditoPrimaCasaSismaAbruzzo m730:CreditoAltriSismaAbruzzo m730:CreditoNegoziazione

element **Modulo_Crediti_Imposta_Type/CreditoImpostaFondiPensione**

diagram	
namespace	urn:www.agenziaentrate.gov.it:specificheTecniche:sco:730
type	m730:Credito_Imposta_Fondi_Pensione_Type
children	m730:AnnoAnticipazione m730:Reintegro m730:SommaReintegrata m730:CreditoAnno

element **Modulo_Crediti_Imposta_Type/CreditiImpostaRedditiEsteri**

diagram	
namespace	urn:www.agenziaentrate.gov.it:specificheTecniche:sco:730
type	m730:Crediti_Imposta_Redditi_Esteri_Type
children	m730:StatoEsteri m730:Anno m730:RedditoEsteri m730:ImpostaEsteri m730:RedditoComplessivo m730:Imposta_Lorda m730:ImpostaNetta m730:CreditoDichiarazioniPrecedenti m730:DiCuiStatoEsteri

element **Modulo_Crediti_Imposta_Type/CreditoPrimaCasaSismaAbruzzo**

diagram	
namespace	urn:www.agenziaentrate.gov.it:specificheTecniche:sco:730
type	m730:Credito_Immobilabile_Sisma_Abruzzo_Type
children	m730:CodiceFiscale m730:NumeroRata m730:TotaleCredito

element **Modulo_Crediti_Imposta_Type/CreditoAltriSismaAbruzzo**

diagram	
namespace	urn:www.agenziaentrate.gov.it:specificheTecniche:sco:730
type	m730:Crediti_Imposta_Altri_Sisma_Abruzzo_Type
children	m730:Impresa_Professione m730:CreditoImmobileSismaAbruzzo m730:Rateazione

element **Modulo_Crediti_Imposta_Type/CreditoNegoziazione**

diagram	
namespace	urn:www.agenziaentrate.gov.it:specificheTecniche:sco:730
type	m730:Modulo_Credito_Negoziatore_Type
children	m730:DiCuiCompensatoF24

complexType **Modulo_Credito_Negoziatore_Type**

diagram	
namespace	urn:www.agenziaentrate.gov.it:specificheTecniche:sco:730
children	m730:DiCuiCompensatoF24

element **Modulo_Credito_Negoziatore_Type/DiCuiCompensatoF24**

diagram					
namespace	urn:www.agenziaentrate.gov.it:specificheTecniche:sco:730				
type	DatoNP_Type				
facets	<table border="1"> <thead> <tr> <th>Kind</th> <th>Value</th> </tr> </thead> <tbody> <tr> <td>pattern</td> <td>[1-9]{1}[0-9]*</td> </tr> </tbody> </table>	Kind	Value	pattern	[1-9]{1}[0-9]*
Kind	Value				
pattern	[1-9]{1}[0-9]*				

complexType **Modulo_Fabbricato_Type**

diagram	
namespace	urn:www.agenziaentrate.gov.it:specificheTecniche:sco:730
children	m730:FabbricatoOrd m730:FabbricatoAgev

element **Modulo_Fabbricato_Type/FabbricatoOrd**

diagram	
namespace	urn:www.agenziaentrate.gov.it:specificheTecniche:sco:730
type	m730:Fabbricato_Ord_Type
children	m730:Rendita m730:Utilizzo m730:GiorniPossesso m730:PercPossesso m730:CodiceCanone m730:CanoneLocazione m730:CasiParticolari m730:CasellaContinuazione m730:CodiceComune m730:OpzioneCedolare m730:CasellaCasiPartimu

element **Modulo_Fabbricato_Type/FabbricatoAgev**

diagram	
namespace	urn:www.agenziaentrate.gov.it:specificheTecniche:sco:730
type	m730:Fabbricato_Agev_Type
children	m730:NumeroRigoRiferimento m730:NumModuloRiferimento m730:DatiContratto m730:CasellaInf30Giorni m730:AnnoDichiarazioneIlcilmu m730:StatoEmergenza

complexType **Modulo_Familiari_Type**

diagram	
namespace	urn:www.agenziaentrate.gov.it:specificheTecniche:sco:730
children	m730:Coniuge m730:PrimoFiglio m730:Familiari

element **Modulo_Familiari_Type/Coniuge**

diagram	
namespace	urn:www.agenziaentrate.gov.it:specificheTecniche:sco:730
type	m730:Dati_Coniuge_Type

children	m730:Tipo m730:CodiceFiscale m730:Mesi
----------	--

element **Modulo_Familiari_Type/PrimoFiglio**

diagram	<p>The diagram illustrates the class m730:PrimoFiglio as an extension of m730:Dati_Familiare_Type. The extension is highlighted in a yellow dashed box and includes the following elements: m730:CodiceFiscale, m730:Mesi, m730:MesiMinore, m730:PercDetraz, m730:PercDetrazCon, m730:Affidamento, and m730:Tipo. The m730:PrimoFiglio class is shown as a dashed box on the left, connected to the extension box.</p>
namespace	urn:www.agenziaentrate.gov.it:specificheTecniche:sco:730
type	extension of m730:Dati_Familiare_Type
children	m730:CodiceFiscale m730:Mesi m730:MesiMinore m730:PercDetraz m730:PercDetrazCon m730:Affidamento m730:Tipo

element **Modulo_Familiari_Type/PrimoFiglio/Tipo**

diagram	<p>The diagram shows the class m730:Tipo as a restriction of DatoAN_Type. The m730:Tipo class is shown as a solid box on the left, connected to the DatoAN_Type class.</p>								
namespace	urn:www.agenziaentrate.gov.it:specificheTecniche:sco:730								
type	restriction of DatoAN_Type								
facets	<table border="1"> <thead> <tr> <th>Kind</th> <th>Value</th> </tr> </thead> <tbody> <tr> <td>pattern</td> <td>([0-9A-Z-] &quot;){1}([0-9A-Z&amp;] ' - .!, /° ^\(\\) À È É Ì Ò Ù Ü &quot;; \\ / +)*</td> </tr> <tr> <td>enumeration</td> <td>F</td> </tr> <tr> <td>enumeration</td> <td>D</td> </tr> </tbody> </table>	Kind	Value	pattern	([0-9A-Z-] "){1}([0-9A-Z&] ' - .!, /° ^\(\\) À È É Ì Ò Ù Ü "; \\ / +)*	enumeration	F	enumeration	D
Kind	Value								
pattern	([0-9A-Z-] "){1}([0-9A-Z&] ' - .!, /° ^\(\\) À È É Ì Ò Ù Ü "; \\ / +)*								
enumeration	F								
enumeration	D								

element **Modulo_Familiari_Type/Familiari**

diagram	
namespace	urn:www.agenziaentrate.gov.it:specificheTecniche:sco:730
type	extension of m730:Dati_Familiare_Type
children	m730:CodiceFiscale m730:Mesi m730:MesiMinore m730:PercDetraz m730:PercDetrazCon m730:Affidamento m730:Tipo

element **Modulo_Familiari_Type/Familiari/Tipo**

diagram											
namespace	urn:www.agenziaentrate.gov.it:specificheTecniche:sco:730										
type	restriction of DatoAN_Type										
facets	<table border="0"> <thead> <tr> <th>Kind</th> <th>Value</th> </tr> </thead> <tbody> <tr> <td>pattern</td> <td>(([0-9A-Z\-_] &quot;){1}([0-9A-Z&amp;:] ' \-\. / ° \\ \\(\\) À Ê É Ì Ò Ù Û &quot; \\ \\ +)*</td> </tr> <tr> <td>enumeration</td> <td>F</td> </tr> <tr> <td>enumeration</td> <td>D</td> </tr> <tr> <td>enumeration</td> <td>A</td> </tr> </tbody> </table>	Kind	Value	pattern	(([0-9A-Z\-_] "){1}([0-9A-Z&:] ' \-\. / ° \\ \\(\\) À Ê É Ì Ò Ù Û " \\ \\ +)*	enumeration	F	enumeration	D	enumeration	A
Kind	Value										
pattern	(([0-9A-Z\-_] "){1}([0-9A-Z&:] ' \-\. / ° \\ \\(\\) À Ê É Ì Ò Ù Û " \\ \\ +)*										
enumeration	F										
enumeration	D										
enumeration	A										

complexType **Modulo_Lavoro_Dip_Type**

diagram	
namespace	urn:www.agenziaentrate.gov.it:specificheTecniche:sco:730

children	m730:LavoroDipendente m730:AltriRedditiAssLavDip m730:Bonuslrpef
----------	--

element **Modulo_Lavoro_Dip_Type/LavoroDipendente**

diagram	
namespace	urn:www.agenziaentrate.gov.it:specificheTecniche:sco:730
type	m730:Lavoro_Dipendente_Type
children	m730:TipologiaReddito m730:TipoContratto m730:Reddito

element **Modulo_Lavoro_Dip_Type/AltriRedditiAssLavDip**

diagram	
namespace	urn:www.agenziaentrate.gov.it:specificheTecniche:sco:730
type	m730:Altri_Redditi_Ass_Lav_Type
children	m730:AssegnoDelConiuge m730:ImportoRedditoAssimilato

element **Modulo_Lavoro_Dip_Type/Bonuslrpef**

diagram	
namespace	urn:www.agenziaentrate.gov.it:specificheTecniche:sco:730
children	m730:Esenzione

element **Modulo_Lavoro_Dip_Type/BonusIrpef/Esenzione**

diagram	
namespace	urn:www.agenziaentrate.gov.it:specificheTecniche:sco:730
type	m730:Esenzione_Bonus_Type
children	m730:TipologiaEsenzione m730:ParteRedditoEsente

complexType **Modulo_Oneri_Type**

diagram	
namespace	urn:www.agenziaentrate.gov.it:specificheTecniche:sco:730
children	m730:SpeseDetrazioni m730:SpeseDeduzioni m730:InterventoRecuperoPatrimonioEdilizio m730:DatiCatastaliRecuperoPatrimonioEdilizio m730:InterventoRisparmioEnergetico m730:CanoniLocazione m730:DatiAltreDetrazioni m730:SpeseArredo

element **Modulo_Oneri_Type/SpeseDetrazioni**

diagram	
namespace	urn:www.agenziaentrate.gov.it:specificheTecniche:sco:730
type	m730:Detrazioni_Modulo_Type
children	m730:VeicoliDisabili m730:AcquistoCaniGuida m730:SpeseRateizzate m730:AltreSpese

element **Modulo_Oneri_Type/SpeseDeduzioni**

diagram	
namespace	urn:www.agenziaentrate.gov.it:specificheTecniche:sco:730
type	m730:Deduzioni_Modulo_Type
children	m730:AssegnoConiuge m730:AltriOneri m730:AcquistoCostruzioneAbitLocazione

element **Modulo_Oneri_Type/InterventoRecuperoPatrimonioEdilizio**

<p>diagram</p>	
<p>namespace</p>	<p>urn:www.agenziaentrate.gov.it:specificheTecniche:sco:730</p>
<p>type</p>	<p>m730:Intervento Recupero Patrimonio Edilizio Type</p>
<p>children</p>	<p>m730:Anno m730:Periodo m730:CodiceFiscale m730:CasellaInterventiParticolari m730:CodiceSituazioniParticolari m730:AnnoSituazioniParticolari m730:RideterminazioneRate m730:NRate m730:Spesa m730:NOrdineImmobile</p>

element **Modulo_Oneri_Type/DatiCatastaliRecuperoPatrimonioEdilizio**

<p>diagram</p>	
<p>namespace</p>	<p>urn:www.agenziaentrate.gov.it:specificheTecniche:sco:730</p>
<p>type</p>	<p>m730:Sezione Dati Catastali Recupero Patrimonio Edilizio Type</p>
<p>children</p>	<p>m730:DatiCatastaliRecuperoPatrimonioEdilizio m730:DatiRegistrazioneAccatastamentoRecuperoPatrimonio Edilizio</p>

element **Modulo_Oneri_Type/InterventoRisparmioEnergetico**

diagram	
namespace	urn:www.agenziaentrate.gov.it:specificheTecniche:sco:730
type	m730:Intervento Risparmio Energetico Type
children	m730:TipoIntervento m730:Anno m730:Periodo2013 m730:CasiParticolari m730:RideterminazioneRate m730:RipartizioneRate m730:NumeroRata m730:Spesa

element **Modulo_Oneri_Type/CanoniLocazione**

diagram	
namespace	urn:www.agenziaentrate.gov.it:specificheTecniche:sco:730
type	m730:Detrazioni Canoni Locazione Type
children	m730:InquiliniAbitazionePrincipale m730:DipendentiTrasferiti

element **Modulo_Oneri_Type/DatiAltreDetrazioni**

diagram	
namespace	urn:www.agenziaentrate.gov.it:specificheTecniche:sco:730

type	m730:Dati Altre Detrazioni Modulo Type
children	m730:AltreDetrazioni

element **Modulo_Oneri_Type/SpeseArredo**

diagram	
namespace	urn:www.agenziaentrate.gov.it:specificheTecniche:sco:730
type	m730:Spese_Arredo_Type
children	m730:NumeroRata m730:Importo

complexType **Modulo_PL_Type**

diagram	
namespace	urn:www.agenziaentrate.gov.it:specificheTecniche:sco:730
children	m730:CredImpEestero

element **Modulo_PL_Type/CredImpEestero**

diagram	
namespace	urn:www.agenziaentrate.gov.it:specificheTecniche:sco:730
type	m730:Cred_Imp_Estero_Type
children	m730:Anno m730:TotCredito m730:CreditoStato

complexType **Modulo_Terreno_Type**

diagram	
namespace	urn:www.agenziaentrate.gov.it:specificheTecniche:sco:730
children	m730:Terreno

element **Modulo_Terreno_Type/Terreno**

diagram	
namespace	urn:www.agenziaentrate.gov.it:specificheTecniche:sco:730
type	m730:Terreno_Type
children	m730:RedDominicale m730:Titolo m730:RedAgrario m730:GiorniPossesso m730:PercPossesso m730:CanoneVincolistico m730:CasiParticolari m730:CasellaContinuazione m730:CasellalmuNonDovuta m730:CasellaColtivatoreDiretto

complexType **N_Rate_Type**

diagram	
namespace	urn:www.agenziaentrate.gov.it:specificheTecniche:sco:730
children	m730:Rate5 m730:Rate10

element N **Rate_Type/Rate5**

diagram							
namespace	urn:www.agenziaentrate.gov.it:specificheTecniche:sco:730						
type	m730:Rate5_Type						
facets	<table border="0"> <tr> <td>Kind</td> <td>Value</td> </tr> <tr> <td>pattern</td> <td>[1-9]{1}[0-9]*</td> </tr> <tr> <td>enumeration</td> <td>5</td> </tr> </table>	Kind	Value	pattern	[1-9]{1}[0-9]*	enumeration	5
Kind	Value						
pattern	[1-9]{1}[0-9]*						
enumeration	5						

element N **Rate_Type/Rate10**

diagram																									
namespace	urn:www.agenziaentrate.gov.it:specificheTecniche:sco:730																								
type	m730:Rate10_Type																								
facets	<table border="0"> <tr> <td>Kind</td> <td>Value</td> </tr> <tr> <td>pattern</td> <td>[1-9]{1}[0-9]*</td> </tr> <tr> <td>enumeration</td> <td>1</td> </tr> <tr> <td>enumeration</td> <td>2</td> </tr> <tr> <td>enumeration</td> <td>3</td> </tr> <tr> <td>enumeration</td> <td>4</td> </tr> <tr> <td>enumeration</td> <td>5</td> </tr> <tr> <td>enumeration</td> <td>6</td> </tr> <tr> <td>enumeration</td> <td>7</td> </tr> <tr> <td>enumeration</td> <td>8</td> </tr> <tr> <td>enumeration</td> <td>9</td> </tr> <tr> <td>enumeration</td> <td>10</td> </tr> </table>	Kind	Value	pattern	[1-9]{1}[0-9]*	enumeration	1	enumeration	2	enumeration	3	enumeration	4	enumeration	5	enumeration	6	enumeration	7	enumeration	8	enumeration	9	enumeration	10
Kind	Value																								
pattern	[1-9]{1}[0-9]*																								
enumeration	1																								
enumeration	2																								
enumeration	3																								
enumeration	4																								
enumeration	5																								
enumeration	6																								
enumeration	7																								
enumeration	8																								
enumeration	9																								
enumeration	10																								

complexType **Oneri_Non_Abbattuti_Type**

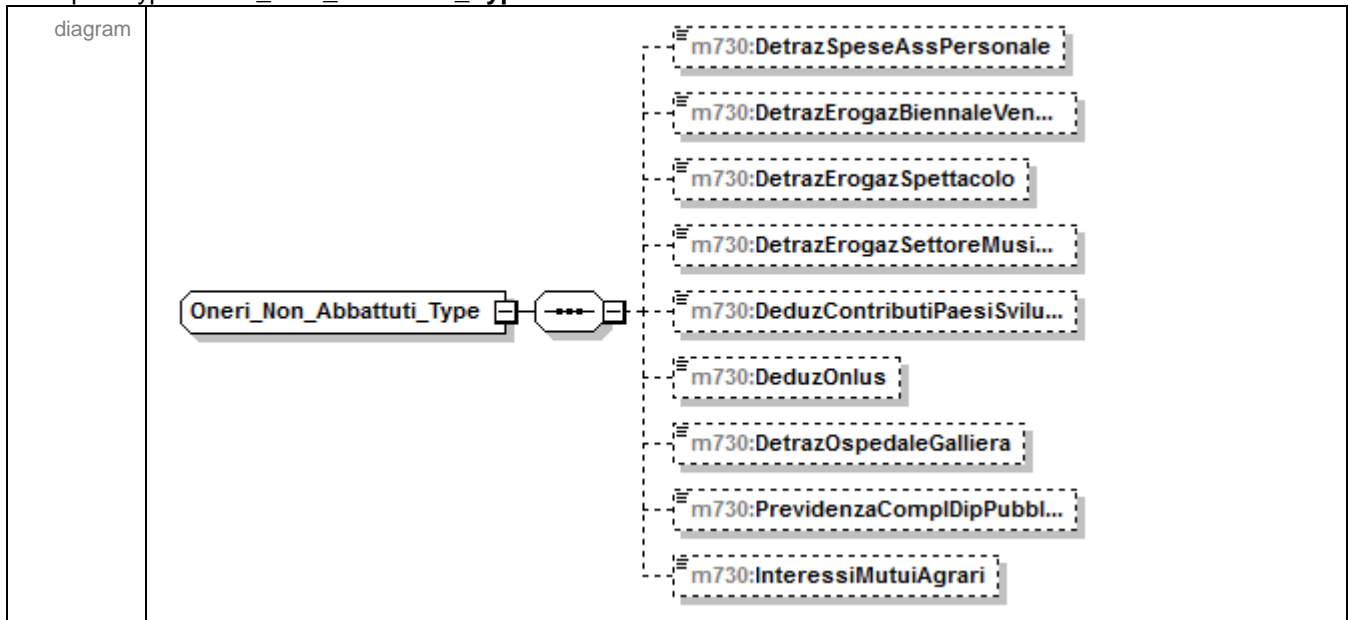

namespace	urn:www.agenziaentrate.gov.it:specificheTecniche:sco:730
children	m730:DetrazSpeseAssPersonale m730:DetrazErogazBiennaleVenezia m730:DetrazErogazSpettacolo m730:DetrazErogazSettoreMusicale m730:DeduzContributiPaesiSviluppo m730:DeduzOnlus m730:DetrazOspedaleGalliera m730:PrevidenzaCompIDipPubblici m730:InteressiMutuiAgrari

element **Oneri_Non_Abbattuti_Type/DetrazSpeseAssPersonale**

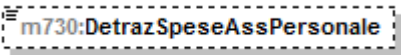
diagram	
namespace	urn:www.agenziaentrate.gov.it:specificheTecniche:sco:730
type	DatoNP_Type
facets	Kind Value pattern [1-9]{1}[0-9]*

element **Oneri_Non_Abbattuti_Type/DetrazErogazBiennaleVenezia**

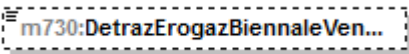
diagram	
namespace	urn:www.agenziaentrate.gov.it:specificheTecniche:sco:730
type	DatoNP_Type
facets	Kind Value pattern [1-9]{1}[0-9]*

element **Oneri_Non_Abbattuti_Type/DetrazErogazSpettacolo**

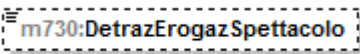
diagram	
namespace	urn:www.agenziaentrate.gov.it:specificheTecniche:sco:730
type	DatoNP_Type
facets	Kind Value pattern [1-9]{1}[0-9]*

element **Oneri_Non_Abbattuti_Type/DetrazErogazSettoreMusicale**

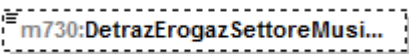
diagram	
namespace	urn:www.agenziaentrate.gov.it:specificheTecniche:sco:730
type	DatoNP_Type
facets	Kind Value pattern [1-9]{1}[0-9]*

element Oneri_Non_Abbattuti_Type/DeduzContributiPaesiSviluppo

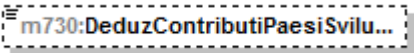
diagram					
namespace	urn:www.agenziaentrate.gov.it:specificheTecniche:sco:730				
type	DatoNP_Type				
facets	<table border="1"> <tr> <td>Kind</td> <td>Value</td> </tr> <tr> <td>pattern</td> <td>[1-9]{1}[0-9]*</td> </tr> </table>	Kind	Value	pattern	[1-9]{1}[0-9]*
Kind	Value				
pattern	[1-9]{1}[0-9]*				

element Oneri_Non_Abbattuti_Type/DeduzOnlus

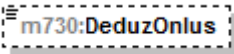
diagram					
namespace	urn:www.agenziaentrate.gov.it:specificheTecniche:sco:730				
type	DatoNP_Type				
facets	<table border="1"> <tr> <td>Kind</td> <td>Value</td> </tr> <tr> <td>pattern</td> <td>[1-9]{1}[0-9]*</td> </tr> </table>	Kind	Value	pattern	[1-9]{1}[0-9]*
Kind	Value				
pattern	[1-9]{1}[0-9]*				

element Oneri_Non_Abbattuti_Type/DetrazOspedaleGalliera

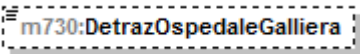
diagram					
namespace	urn:www.agenziaentrate.gov.it:specificheTecniche:sco:730				
type	DatoNP_Type				
facets	<table border="1"> <tr> <td>Kind</td> <td>Value</td> </tr> <tr> <td>pattern</td> <td>[1-9]{1}[0-9]*</td> </tr> </table>	Kind	Value	pattern	[1-9]{1}[0-9]*
Kind	Value				
pattern	[1-9]{1}[0-9]*				

element Oneri_Non_Abbattuti_Type/PrevidenzaCompIDipPubblici

diagram					
namespace	urn:www.agenziaentrate.gov.it:specificheTecniche:sco:730				
type	DatoNP_Type				
facets	<table border="1"> <tr> <td>Kind</td> <td>Value</td> </tr> <tr> <td>pattern</td> <td>[1-9]{1}[0-9]*</td> </tr> </table>	Kind	Value	pattern	[1-9]{1}[0-9]*
Kind	Value				
pattern	[1-9]{1}[0-9]*				

element Oneri_Non_Abbattuti_Type/InteressiMutuiAgrari

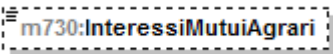
diagram					
namespace	urn:www.agenziaentrate.gov.it:specificheTecniche:sco:730				
type	DatoNP_Type				
facets	<table border="1"> <tr> <td>Kind</td> <td>Value</td> </tr> <tr> <td>pattern</td> <td>[1-9]{1}[0-9]*</td> </tr> </table>	Kind	Value	pattern	[1-9]{1}[0-9]*
Kind	Value				
pattern	[1-9]{1}[0-9]*				

complexType Oneri_Type

diagram	
namespace	urn:www.agenziaentrate.gov.it:specificheTecniche:sco:730
children	m730:PrimoModulo m730:Modulo

element Oneri_Type/PrimoModulo

diagram	
namespace	urn:www.agenziaentrate.gov.it:specificheTecniche:sco:730
type	m730:Primo_Modulo_Oneri_Type
children	m730:SpeseDetrazioni m730:SpeseDeduzioni m730:InterventoRecuperoPatrimonioEdilizio m730:DatiCatastaliRecuperoPatrimonioEdilizio m730:InterventoRisparmioEnergetico m730:CanoniLocazione m730:DatiAltreDetrazioni m730:OneriNonAbbattuti m730:SpeseArredo

element **Oneri_Type/Modulo**

diagram	
namespace	urn:www.agenziaentrate.gov.it:specificheTecniche:sco:730
type	m730:Modulo_Oneri_Type
children	m730:SpeseDetrazioni m730:SpeseDeduzioni m730:InterventoRecuperoPatrimonioEdilizio m730:DatiCatastaliRecuperoPatrimonioEdilizio m730:InterventoRisparmioEnergetico m730:CanoniLocazione m730:DatiAltreDetrazioni m730:SpeseArredo

complexType **Opzione_Produttivita_Type**

diagram	
namespace	urn:www.agenziaentrate.gov.it:specificheTecniche:sco:730

complexType **Periodo_Di_Lavoro_Type**

diagram	
namespace	urn:www.agenziaentrate.gov.it:specificheTecniche:sco:730
children	m730:GiorniLavoroDipendente m730:GiorniPensione

element **Periodo_Di_Lavoro_Type/GiorniLavoroDipendente**

diagram					
namespace	urn:www.agenziaentrate.gov.it:specificheTecniche:sco:730				
type	DatoGA_Type				
facets	<table border="1"> <tr> <td>Kind</td> <td>Value</td> </tr> <tr> <td>pattern</td> <td>[1-9] ((1-9)[0-9]) ((12)[0-9][0-9]) (3[0-5][0-9]) (36[0-5])</td> </tr> </table>	Kind	Value	pattern	[1-9] ((1-9)[0-9]) ((12)[0-9][0-9]) (3[0-5][0-9]) (36[0-5])
Kind	Value				
pattern	[1-9] ((1-9)[0-9]) ((12)[0-9][0-9]) (3[0-5][0-9]) (36[0-5])				

element **Periodo_Di_Lavoro_Type/GiorniPensione**

diagram					
namespace	urn:www.agenziaentrate.gov.it:specificheTecniche:sco:730				
type	DatoGA_Type				
facets	<table border="1"> <tr> <td>Kind</td> <td>Value</td> </tr> <tr> <td>pattern</td> <td>[1-9] ((1-9)[0-9]) ((12)[0-9][0-9]) (3[0-5][0-9]) (36[0-5])</td> </tr> </table>	Kind	Value	pattern	[1-9] ((1-9)[0-9]) ((12)[0-9][0-9]) (3[0-5][0-9]) (36[0-5])
Kind	Value				
pattern	[1-9] ((1-9)[0-9]) ((12)[0-9][0-9]) (3[0-5][0-9]) (36[0-5])				

complexType **Pignoramento_Type**

diagram	
namespace	urn:www.agenziaentrate.gov.it:specificheTecniche:sco:730
children	m730:TipoRedditoPignoramento m730:RitenutePignoramento

element **Pignoramento_Type/TipoRedditoPignoramento**

diagram																	
namespace	urn:www.agenziaentrate.gov.it:specificheTecniche:sco:730																
type	restriction of DatoN1_Type																
facets	<table border="1"> <tr> <td>Kind</td> <td>Value</td> </tr> <tr> <td>pattern</td> <td>[1-9]</td> </tr> <tr> <td>enumeration</td> <td>1</td> </tr> <tr> <td>enumeration</td> <td>2</td> </tr> <tr> <td>enumeration</td> <td>3</td> </tr> <tr> <td>enumeration</td> <td>4</td> </tr> <tr> <td>enumeration</td> <td>5</td> </tr> <tr> <td>enumeration</td> <td>6</td> </tr> </table>	Kind	Value	pattern	[1-9]	enumeration	1	enumeration	2	enumeration	3	enumeration	4	enumeration	5	enumeration	6
Kind	Value																
pattern	[1-9]																
enumeration	1																
enumeration	2																
enumeration	3																
enumeration	4																
enumeration	5																
enumeration	6																

element **Pignoramento_Type/RitenutePignoramento**

diagram	
namespace	urn:www.agenziaentrate.gov.it:specificheTecniche:sco:730

type	DatoNP_Type	
facets	Kind	Value
	pattern	[1-9]{1}[0-9]*

complexType [Primo_Modulo_Acconti_Ritenute_Type](#)

diagram		
namespace	urn:www.agenziaentrate.gov.it:specificheTecniche:sco:730	
children	m730:Accontilrpef m730:AltreRitenute m730:Eccedenze m730:RitenuteAccontiSospesi m730:MisuraAcconti m730:EsenzioneAddComunale m730:Dati730Integrativo m730:AccontiAltriDati	

element [Primo_Modulo_Acconti_Ritenute_Type/Accontilrpef](#)

diagram		
namespace	urn:www.agenziaentrate.gov.it:specificheTecniche:sco:730	
type	m730:Acconti_Irpef_Anno_Imposta_Type	
children	m730:PrimaRataAccontilrpef m730:SecondaRataAccontilrpef m730:AccontoAddComunale m730:AccontoAddComunaleF24 m730:PrimaRataAccontoCedolare m730:SecondaRataAccontoCedolare	

element **Primo_Modulo_Aconti_Ritenute_Type/AltreRitenute**

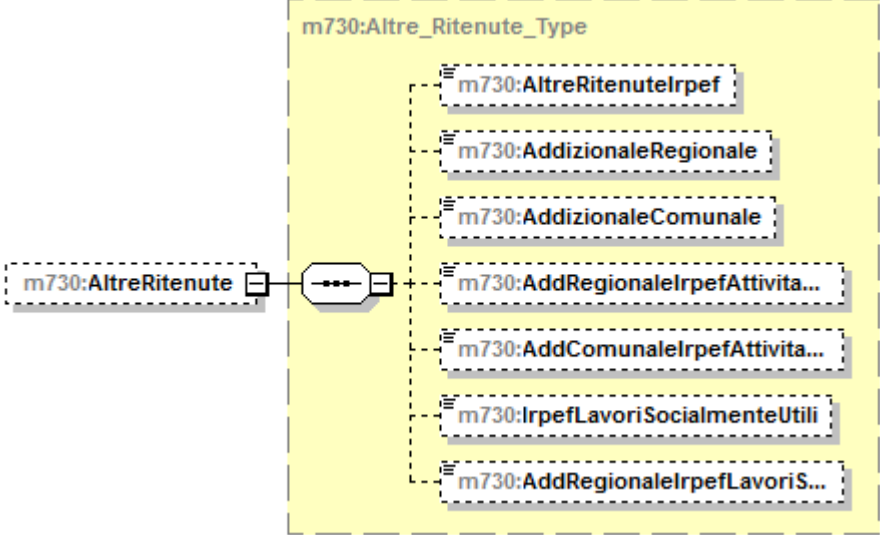
<p>diagram</p>	 <p>The diagram illustrates the structure of the <code>m730:AltreRitenute</code> element. It is composed of a <code>m730:AltreRitenute_Type</code> container (highlighted in yellow) and several sub-elements. The sub-elements are:</p> <ul style="list-style-type: none"> <code>m730:AltreRitenuteIrpef</code> <code>m730:AddizionaleRegionale</code> <code>m730:AddizionaleComunale</code> <code>m730:AddRegionaleIrpefAttivita...</code> <code>m730:AddComunaleIrpefAttivita...</code> <code>m730:IrpefLavoriSocialmenteUtili</code> <code>m730:AddRegionaleIrpefLavoriS...</code> <p>The <code>m730:AltreRitenute</code> element is connected to the <code>m730:AltreRitenute_Type</code> container via a composition relationship (indicated by a solid line with an open arrowhead). The container is further composed of the listed sub-elements (indicated by dashed lines with open arrowheads).</p>
<p>namespace</p>	<p>urn:www.agenziaentrate.gov.it:specificheTecniche:sco:730</p>
<p>type</p>	<p>m730:Altre_Ritenute_Type</p>
<p>children</p>	<p>m730:AltreRitenuteIrpef m730:AddizionaleRegionale m730:AddizionaleComunale m730:AddRegionaleIrpefAttivitaSport m730:AddComunaleIrpefAttivitaSport m730:IrpefLavoriSocialmenteUtili m730:AddRegionaleIrpefLavoriSoc Utili</p>

element **Primo_Modulo_Acconti_Ritenute_Type/Eccedenze**

<p>diagram</p>	
<p>namespace</p>	<p>urn:www.agenziaentrate.gov.it:specificheTecniche:sco:730</p>
<p>type</p>	<p>m730:Eccedenze_Type</p>
<p>children</p>	<p>m730:Irpef m730:IrpefCompF24 m730:SostitutivaQuadroRT m730:SostitutivaQuadroRTcompF24 m730:CedolareSecca m730:CedolareSeccaCompF24 m730:CodiceRegione m730:AddRegionaleIrpef m730:AddRegionaleIrpefCompF24 m730:CodiceCatastaleComune m730:AddComunaleIrpef m730:AddComunaleIrpefF24</p>

element **Primo_Modulo_Acconti_Ritenute_Type/RitenuteAccontiSospesi**

diagram	
namespace	urn:www.agenziaentrate.gov.it:specificheTecniche:sco:730
type	m730:Ritenute_Acconti_Sospesi_Type
children	m730:CodiceEvento m730:Irpef m730:AddRegionaleIrpef m730:AddComunaleIrpef m730:CedolareSecca m730:ContribSolidarieta

element **Primo_Modulo_Acconti_Ritenute_Type/MisuraAcconti**

diagram	
namespace	urn:www.agenziaentrate.gov.it:specificheTecniche:sco:730
type	m730:Misura_Acconti_Type
children	m730:IrpefMisuralInferiore m730:AddComunaleMisuralInferiore m730:CedolareSeccaMisuralInferiore m730:NumeroRate

element **Primo_Modulo_Acconti_Ritenute_Type/EsenzioneAddComunale**

diagram	
namespace	urn:www.agenziaentrate.gov.it:specificheTecniche:sco:730
type	m730:Esenzione Add Comunale Type
children	m730:SogliaEsenzioneSaldo m730:SogliaEsenzioneAcconto

element **Primo_Modulo_Acconti_Ritenute_Type/Dati730Integrativo**

diagram	
namespace	urn:www.agenziaentrate.gov.it:specificheTecniche:sco:730
type	m730:Dati 730 Integrativo Type
children	m730:Rimborso m730:Credito

element **Primo_Modulo_Acconti_Ritenute_Type/AccontiAltriDati**

diagram	
namespace	urn:www.agenziaentrate.gov.it:specificheTecniche:sco:730
type	m730:Acconti Altri Dati Type
children	m730:IncapientiDetrazioneFigli m730:IncapientiDetrazioneLocazione m730:RestituzioneBonusFiscale m730:RestituzioneBonusStraordinario m730:Pignoramento

complexType **Primo_Modulo_Crediti_Imposta_Type**

diagram	
namespace	urn:www.agenziaentrate.gov.it:specificheTecniche:sco:730
children	m730:CreditoImpostaFabbricati m730:CreditoImpostaFondiPensione m730:CreditoImpostaRedditiEsteri m730:CreditoPrimaCasaSismaAbruzzo m730:CreditoAltriSismaAbruzzo m730:CreditoIncrementoOccupazione m730:CreditoImpostaMediazioni m730:CreditoErogazioniCultura m730:CreditoNegoziazione

element **Primo_Modulo_Crediti_Imposta_Type/CreditoImpostaFabbricati**

diagram	
namespace	urn:www.agenziaentrate.gov.it:specificheTecniche:sco:730
type	m730:Crediti_Imposta_Fabbricati_Type
children	m730:ResiduoFabbricati m730:CanoniLocazioneNonPercepiti

element **Primo_Modulo_Crediti_Imposta_Type/CreditiImpostaFondiPensione**

diagram	
namespace	urn:www.agenziaentrate.gov.it:specificheTecniche:sco:730
type	extension of m730:Crediti_Imposta_Fondi_Pensione_Type
children	m730:AnnoAnticipazione m730:Reintegro m730:SommaReintegrata m730:CreditoAnno m730:ResiduoPrecedenteDichiarazione m730:DiCuiCompensatoF24

element

Primo_Modulo_Crediti_Imposta_Type/CreditiImpostaFondiPensione/ResiduoPrecedenteDichiarazione

diagram					
namespace	urn:www.agenziaentrate.gov.it:specificheTecniche:sco:730				
type	DatoNP_Type				
facets	<table border="1"> <thead> <tr> <th>Kind</th> <th>Value</th> </tr> </thead> <tbody> <tr> <td>pattern</td> <td>[1-9]{1}[0-9]*</td> </tr> </tbody> </table>	Kind	Value	pattern	[1-9]{1}[0-9]*
Kind	Value				
pattern	[1-9]{1}[0-9]*				

element **Primo_Modulo_Crediti_Imposta_Type/CreditiImpostaFondiPensione/DiCuiCompensatoF24**

diagram					
namespace	urn:www.agenziaentrate.gov.it:specificheTecniche:sco:730				
type	DatoNP_Type				
facets	<table border="1"> <thead> <tr> <th>Kind</th> <th>Value</th> </tr> </thead> <tbody> <tr> <td>pattern</td> <td>[1-9]{1}[0-9]*</td> </tr> </tbody> </table>	Kind	Value	pattern	[1-9]{1}[0-9]*
Kind	Value				
pattern	[1-9]{1}[0-9]*				

element **Primo_Modulo_Crediti_Imposta_Type/CreditiImpostaRedditiEsteri**

diagram	
namespace	urn:www.agenziaentrate.gov.it:specificheTecniche:sco:730
type	m730:Crediti_Imposta_Redditi_Esteri_Type
children	m730:StatoEsteri m730:Anno m730:RedditoEsteri m730:ImpostaEsteri m730:RedditoComplessivo m730:Imposta_Lorda m730:ImpostaNetta m730:CreditoDichiarazioniPrecedenti m730:DiCuiStatoEsteri

element **Primo_Modulo_Crediti_Imposta_Type/CreditoPrimaCasaSismaAbruzzo**

diagram	
namespace	urn:www.agenziaentrate.gov.it:specificheTecniche:sco:730
type	extension of m730:Credito_Immibile_Sisma_Abruzzo_Type
children	m730:CodiceFiscale m730:NumeroRata m730:TotaleCredito m730:ResiduoPrecedenteDichiarazione

element **Primo_Modulo_Crediti_Imposta_Type/CreditoPrimaCasaSismaAbruzzo/ResiduoPrecedenteDichiarazio**

ne

diagram	
namespace	urn:www.agenziaentrate.gov.it:specificheTecniche:sco:730
type	DatoNP_Type
facets	Kind Value pattern [1-9]{1}[0-9]*

element **Primo Modulo Crediti Imposta Type/CreditoAltriSismaAbruzzo**

diagram	
namespace	urn:www.agenziaentrate.gov.it:specificheTecniche:sco:730
type	m730:Crediti Imposta Altri Sisma Abruzzo Type
children	m730:Impresa Professione m730:CreditoImmobileSismaAbruzzo m730:Rateazione

element **Primo Modulo Crediti Imposta Type/CreditoIncrementoOccupazione**

diagram	
namespace	urn:www.agenziaentrate.gov.it:specificheTecniche:sco:730
type	m730:Credito Incremento Occupazione Type
children	m730:ResiduoPrecedenteDichiarazione m730:DiCuiCompensatoF24

element **Primo Modulo Crediti Imposta Type/CreditoImpostaMediazioni**

diagram	
---------	--

namespace	urn:www.agenziaentrate.gov.it:specificheTecniche:sco:730
type	m730:Residuo_Credito_Compens_AnnoImposta_Type
children	m730:CreditoAnno m730:DiCuiCompensatoF24

element **Primo_Modulo_Crediti_Imposta_Type/CreditoErogazioniCultura**

diagram	<pre> classDiagram class m730CreditoErogazioniCultura class m730SpesaAnno class m730ResiduoAnnoPrec class m730RataAnnoPrec m730CreditoErogazioniCultura "1" *-- "1" m730SpesaAnno m730CreditoErogazioniCultura "1" *-- "1" m730ResiduoAnnoPrec m730CreditoErogazioniCultura "1" *-- "1" m730RataAnnoPrec </pre>
namespace	urn:www.agenziaentrate.gov.it:specificheTecniche:sco:730
type	m730:Credito_Erogazioni_Cultura_Type
children	m730:SpesaAnno m730:ResiduoAnnoPrec m730:RataAnnoPrec

element **Primo_Modulo_Crediti_Imposta_Type/CreditoNegoziazione**

diagram	<pre> classDiagram class m730CreditoNegoziazione class m730CreditoSpettante class m730DiCuiCompensatoF24 m730CreditoNegoziazione "1" *-- "1" m730CreditoSpettante m730CreditoNegoziazione "1" *-- "1" m730DiCuiCompensatoF24 </pre>
namespace	urn:www.agenziaentrate.gov.it:specificheTecniche:sco:730
type	m730:Credito_Negoziazione_Type
children	m730:CreditoSpettante m730:DiCuiCompensatoF24

complexType **Primo_Modulo_Familiari_Type**

diagram	
namespace	urn:www.agenziaentrate.gov.it:specificheTecniche:sco:730
type	extension of m730:Modulo_Familiari_Type
children	m730:Coniuge m730:PrimoFiglio m730:Familiari m730:PercUlteriore m730:FigliAffidoPread

element **Primo_Modulo_Familiari_Type/PercUlteriore**

diagram					
namespace	urn:www.agenziaentrate.gov.it:specificheTecniche:sco:730				
type	DatoPC_Type				
facets	<table border="1"> <thead> <tr> <th>Kind</th> <th>Value</th> </tr> </thead> <tbody> <tr> <td>pattern</td> <td>[0-9]?[0-9](,\.d{1,3})? 100(,0{1,3})?</td> </tr> </tbody> </table>	Kind	Value	pattern	[0-9]?[0-9](,\.d{1,3})? 100(,0{1,3})?
Kind	Value				
pattern	[0-9]?[0-9](,\.d{1,3})? 100(,0{1,3})?				

element **Primo_Modulo_Familiari_Type/FigliAffidoPread**

diagram					
namespace	urn:www.agenziaentrate.gov.it:specificheTecniche:sco:730				
type	DatoNP_Type				
facets	<table border="1"> <thead> <tr> <th>Kind</th> <th>Value</th> </tr> </thead> <tbody> <tr> <td>pattern</td> <td>[1-9]{1}[0-9]*</td> </tr> </tbody> </table>	Kind	Value	pattern	[1-9]{1}[0-9]*
Kind	Value				
pattern	[1-9]{1}[0-9]*				

complexType **Primo_Modulo_Lavoro_Dip_Type**

diagram	
namespace	urn:www.agenziaentrate.gov.it:specificheTecniche:sco:730
children	m730:LavoroDipendente m730:PeriodoLavoro m730:AltriRedditiAssLavDip m730:RitenuteLavoroDipendente m730:Bonuslrpef m730:RedditoAllNettoContribPensioni m730:ContribSolidarietaTrattenuato m730:CasellaCasiParticolari

element **Primo_Modulo_Lavoro_Dip_Type/LavoroDipendente**

diagram	
namespace	urn:www.agenziaentrate.gov.it:specificheTecniche:sco:730
type	m730:Lavoro_Dipendente_Type
children	m730:TipologiaReddito m730:TipoContratto m730:Reddito

element **Primo_Modulo_Lavoro_Dip_Type/PeriodoLavoro**

diagram	<p>The diagram shows a class <code>m730:PeriodoLavoro</code> (dashed border) connected to a class <code>m730:Periodo_Di_Lavoro_Type</code> (solid border, highlighted in yellow). Inside <code>m730:Periodo_Di_Lavoro_Type</code>, there are two subclasses: <code>m730:GiorniLavoroDipendente</code> and <code>m730:GiorniPensione</code> (both dashed borders).</p>
namespace	urn:www.agenziaentrate.gov.it:specificheTecniche:sco:730
type	m730:Periodo Di Lavoro Type
children	m730:GiorniLavoroDipendente m730:GiorniPensione

element **Primo_Modulo_Lavoro_Dip_Type/AltriRedditiAssLavDip**

diagram	<p>The diagram shows a class <code>m730:AltriRedditiAssLavDip</code> (dashed border) connected to a class <code>m730:Altri_Redditi_Ass_Lav_Type</code> (solid border, highlighted in yellow). Inside <code>m730:Altri_Redditi_Ass_Lav_Type</code>, there are two subclasses: <code>m730:AssegnoDelConiuge</code> and <code>m730:ImportoRedditoAssimilato</code> (both dashed borders). The association between <code>m730:AltriRedditiAssLavDip</code> and <code>m730:Altri_Redditi_Ass_Lav_Type</code> has a multiplicity of 0..3.</p>
namespace	urn:www.agenziaentrate.gov.it:specificheTecniche:sco:730
type	m730:Altri Redditi Ass Lav Type
children	m730:AssegnoDelConiuge m730:ImportoRedditoAssimilato

element **Primo_Modulo_Lavoro_Dip_Type/RitenuteLavoroDipendente**

diagram	<p>The diagram shows a class <code>m730:RitenuteLavoroDipendente</code> (dashed border) connected to a class <code>m730:Ritenute_Lavoro_Dip_Type</code> (solid border, highlighted in yellow). Inside <code>m730:Ritenute_Lavoro_Dip_Type</code>, there are five subclasses: <code>m730:Ritlrpef</code>, <code>m730:RitAddRegionale</code>, <code>m730:RitAccAddComunale</code>, <code>m730:RitSaldoAddComunale</code>, and <code>m730:RitAccAddComAnnoPres</code> (all dashed borders).</p>
namespace	urn:www.agenziaentrate.gov.it:specificheTecniche:sco:730
type	m730:Ritenute Lavoro Dip Type
children	m730:Ritlrpef m730:RitAddRegionale m730:RitAccAddComunale m730:RitSaldoAddComunale m730:RitAccAddComAnnoPres

element **Primo_Modulo_Lavoro_Dip_Type/BonusIrpef**

diagram	
namespace	urn:www.agenziaentrate.gov.it:specificheTecniche:sco:730
type	m730:Bonus_Irpef_Type
children	m730:CodiceBonus m730:BonusErogato m730:Esenzione m730:QuotaTfr

element **Primo_Modulo_Lavoro_Dip_Type/RedditoAlNettoContribPensioni**

diagram					
namespace	urn:www.agenziaentrate.gov.it:specificheTecniche:sco:730				
type	DatoNP_Type				
facets	<table border="1"> <thead> <tr> <th>Kind</th> <th>Value</th> </tr> </thead> <tbody> <tr> <td>pattern</td> <td>[1-9]{1}[0-9]*</td> </tr> </tbody> </table>	Kind	Value	pattern	[1-9]{1}[0-9]*
Kind	Value				
pattern	[1-9]{1}[0-9]*				

element **Primo_Modulo_Lavoro_Dip_Type/ContribSolidarietaTrattenuto**

diagram					
namespace	urn:www.agenziaentrate.gov.it:specificheTecniche:sco:730				
type	DatoNP_Type				
facets	<table border="1"> <thead> <tr> <th>Kind</th> <th>Value</th> </tr> </thead> <tbody> <tr> <td>pattern</td> <td>[1-9]{1}[0-9]*</td> </tr> </tbody> </table>	Kind	Value	pattern	[1-9]{1}[0-9]*
Kind	Value				
pattern	[1-9]{1}[0-9]*				

element **Primo_Modulo_Lavoro_Dip_Type/CasellaCasiParticolari**

diagram											
namespace	urn:www.agenziaentrate.gov.it:specificheTecniche:sco:730										
type	restriction of DatoN1_Type										
facets	<table border="1"> <thead> <tr> <th>Kind</th> <th>Value</th> </tr> </thead> <tbody> <tr> <td>pattern</td> <td>[1-9]</td> </tr> <tr> <td>enumeration</td> <td>1</td> </tr> <tr> <td>enumeration</td> <td>2</td> </tr> <tr> <td>enumeration</td> <td>3</td> </tr> </tbody> </table>	Kind	Value	pattern	[1-9]	enumeration	1	enumeration	2	enumeration	3
Kind	Value										
pattern	[1-9]										
enumeration	1										
enumeration	2										
enumeration	3										

complexType **Primo_Modulo_Oneri_Type**

<p>diagram</p>	
<p>namespace</p>	<p>urn:www.agenziaentrate.gov.it:specificheTecniche:sco:730</p>
<p>children</p>	<p>m730:SpeseDetrazioni m730:SpeseDeduzioni m730:InterventoRecuperoPatrimonioEdilizio m730:DatiCatastaliRecuperoPatrimonioEdilizio m730:InterventoRisparmioEnergetico m730:CanoniLocazione m730:DatiAltreDetrazioni m730:OneriNonAbbattuti m730:SpeseArredo</p>

element **Primo_Modulo_Oneri_Type/SpeseDetrazioni**

<p>diagram</p>	
<p>namespace</p>	<p>urn:www.agenziaentrate.gov.it:specificheTecniche:sco:730</p>
<p>type</p>	<p>m730:Detrazioni_Type</p>
<p>children</p>	<p>m730:CasellaRateazione m730:SpeseDeterminatePatologie m730:SpeseSanitarie m730:SpeseFamNonACarico m730:SpeseSanitarieDisabili m730:VeicoliDisabili m730:AcquistoCaniGuida m730:SpeseRateizzate m730:MutuiAbPrincipale m730:AltreSpese</p>

element **Primo_Modulo_Oneri_Type/SpeseDeduzioni**

<p>diagram</p>	<p>The diagram illustrates the composition of the <code>m730:SpeseDeduzioni</code> class. It is composed of the following elements from the <code>m730:Deduzioni_Type</code> hierarchy:</p> <ul style="list-style-type: none"> <code>m730:ContributiPrevAss</code> <code>m730:AssegnoConiuge</code> <code>m730:ContributiColf</code> <code>m730:ErogazioniIstituzioniReligi...</code> <code>m730:SpesePortatoriHandicap</code> <code>m730:AltriOneri</code> <code>m730:DeducibilitaOrdinaria</code> <code>m730:LavoratoriPrimaOccupazi...</code> <code>m730:FondiInSquilibrioFinanzia...</code> <code>m730:FamiliariACarico</code> <code>m730:FondoPensioneDipenden...</code> <code>m730:AcquistoCostruzioneAbit...</code> <code>m730:RestituzioneSomme</code>
<p>namespace</p>	<p>urn:www.agenziaentrate.gov.it:specificheTecniche:sco:730</p>
<p>type</p>	<p>m730:Deduzioni_Type</p>
<p>children</p>	<p>m730:ContributiPrevAss m730:AssegnoConiuge m730:ContributiColf m730:ErogazioniIstituzioniReligiose m730:SpesePortatoriHandicap m730:AltriOneri m730:DeducibilitaOrdinaria m730:LavoratoriPrimaOccupazione m730:FondiInSquilibrioFinanziario m730:FamiliariACarico m730:FondoPensioneDipendentiPubblici m730:AcquistoCostruzioneAbitLocazione m730:RestituzioneSomme</p>

element **Primo_Modulo_Oneri_Type/InterventoRecuperoPatrimonioEdilizio**

<p>diagram</p>	
<p>namespace</p>	<p>urn:www.agenziaentrate.gov.it:specificheTecniche:sco:730</p>
<p>type</p>	<p>m730:Intervento Recupero Patrimonio Edilizio Type</p>
<p>children</p>	<p>m730:Anno m730:Periodo m730:CodiceFiscale m730:CasellaInterventiParticolari m730:CodiceSituazioniParticolari m730:AnnoSituazioniParticolari m730:RideterminazioneRate m730:NRate m730:Spesa m730:NOrdineImmobile</p>

element **Primo_Modulo_Oneri_Type/DatiCatastaliRecuperoPatrimonioEdilizio**

<p>diagram</p>	
<p>namespace</p>	<p>urn:www.agenziaentrate.gov.it:specificheTecniche:sco:730</p>
<p>type</p>	<p>m730:Sezione Dati Catastali Recupero Patrimonio Edilizio Type</p>
<p>children</p>	<p>m730:DatiCatastaliRecuperoPatrimonioEdilizio m730:DatiRegistrazioneAccatastamentoRecuperoPatrimonio Edilizio</p>

element **Primo_Modulo_Oneri_Type/InterventoRisparmioEnergico**

<p>diagram</p>	
<p>namespace</p>	<p>urn:www.agenziaentrate.gov.it:specificheTecniche:sco:730</p>
<p>type</p>	<p>m730:Intervento Risparmio Energetico Type</p>
<p>children</p>	<p>m730:TipoIntervento m730:Anno m730:Periodo2013 m730:CasiParticolari m730:RideterminazioneRate m730:RipartizioneRate m730:NumeroRata m730:Spesa</p>

element **Primo_Modulo_Oneri_Type/CanoniLocazione**

<p>diagram</p>	
<p>namespace</p>	<p>urn:www.agenziaentrate.gov.it:specificheTecniche:sco:730</p>
<p>type</p>	<p>m730:Detrazioni Canoni Locazione Type</p>
<p>children</p>	<p>m730:InquiliniAbitazionePrincipale m730:DipendentiTrasferiti</p>

element **Primo_Modulo_Oneri_Type/DatiAltreDetrazioni**

diagram	
namespace	urn:www.agenziaentrate.gov.it:specificheTecniche:sco:730
type	m730:Dati_Altre_Detrazioni_Type
children	m730:SpeseCaniGuida m730:AffittoTerreniAgricoliGiovani m730:AltreDetrazioni

element **Primo_Modulo_Oneri_Type/OneriNonAbbattuti**

diagram	
namespace	urn:www.agenziaentrate.gov.it:specificheTecniche:sco:730
type	m730:Oneri_Non_Abbattuti_Type
children	m730:DetrazSpeseAssPersonale m730:DetrazErogazBiennaleVenezia m730:DetrazErogazSpettacolo m730:DetrazErogazSettoreMusicale m730:DeduzContributiPaesiSviluppo m730:DeduzOnlus m730:DetrazOspedaleGalliera m730:PrevidenzaCompIDipPubblici m730:InteressiMutuiAgrari

element **Primo_Modulo_Oneri_Type/SpeseArredo**

diagram	
namespace	urn:www.agenziaentrate.gov.it:specificheTecniche:sco:730
type	m730:Spese_Arredo_Type
children	m730:NumeroRata m730:Importo

complexType **Primo_Modulo_PL_Type**

diagram	
namespace	urn:www.agenziaentrate.gov.it:specificheTecniche:sco:730
children	m730:Prospetto m730:ProspettoRideterminato

element **Primo_Modulo_PL_Type/Prospetto**

<p>diagram</p>	
<p>namespace</p>	<p>urn:www.agenziaentrate.gov.it:specificheTecniche:sco:730</p>
<p>type</p>	<p>extension of m730:Prospetto_Type</p>
<p>children</p>	<p>m730:RiepilogoRedditi m730:ImpostaLorda m730:DetrazioniCrediti m730:ImpostaNetta m730:Addizionali m730:CedolareSecca m730:ContributoSolidarieta m730:LiquidazioneImposte m730:AltriDati m730:CredImpEestero m730:DatiCreditiF24</p>

element **Primo_Modulo_PL_Type/Prospetto/Addizionali**

diagram	
namespace	urn:www.agenziaentrate.gov.it:specificheTecniche:sco:730
type	m730:Addizionali_Type
children	m730:Imponibile m730:AddRegDovuta m730:AddRegCertif m730:EccedenzaAddReg m730:AddComDovuta m730:AddComCertif m730:EccedenzaAddCom m730:AccontoAddCom m730:AccontoAddComCertif

element **Primo_Modulo_PL_Type/Prospetto/CedolareSecca**

diagram	
namespace	urn:www.agenziaentrate.gov.it:specificheTecniche:sco:730
type	m730:Cedolare_Secca_Type
children	m730:CedolareDovuta m730:EccedenzaCedolareSecca m730:AccontoCedolare

element **Primo_Modulo_PL_Type/Prospetto/ContributoSolidarieta**

diagram	<pre> classDiagram class m730_ContributoSolidarieta class m730_Contributo_Solidarieta_Type { m730_ImponibileContributo m730_ContributoDovuto m730_ContributoCertificaz } m730_ContributoSolidarieta < -- m730_Contributo_Solidarieta_Type </pre>
namespace	urn:www.agenziaentrate.gov.it:specificheTecniche:sco:730
type	m730:Contributo_Solidarieta_Type
children	m730:ImponibileContributo m730:ContributoDovuto m730:ContributoCertificaz

element **Primo_Modulo_PL_Type/Prospetto/LiquidazioneImposte**

diagram	<pre> classDiagram class m730_LiquidazioneImposte class m730_EsitoIrpref class m730_EsitoAddRegionale class m730_EsitoAddComunale class m730_PrimaRataAcclIrpref class m730_SecondaRataAcclIrpref class m730_AccontoTassSep class m730_AccontoAddComunale class m730_EsitoCedolareSecca class m730_PrimaRataAccCedolare class m730_SecondaRataAccCedolare class m730_ContribSolidarietaDebito m730_LiquidazioneImposte < -- m730_EsitoIrpref m730_LiquidazioneImposte < -- m730_EsitoAddRegionale m730_LiquidazioneImposte < -- m730_EsitoAddComunale m730_LiquidazioneImposte < -- m730_PrimaRataAcclIrpref m730_LiquidazioneImposte < -- m730_SecondaRataAcclIrpref m730_LiquidazioneImposte < -- m730_AccontoTassSep m730_LiquidazioneImposte < -- m730_AccontoAddComunale m730_LiquidazioneImposte < -- m730_EsitoCedolareSecca m730_LiquidazioneImposte < -- m730_PrimaRataAccCedolare m730_LiquidazioneImposte < -- m730_SecondaRataAccCedolare m730_LiquidazioneImposte < -- m730_ContribSolidarietaDebito </pre>
namespace	urn:www.agenziaentrate.gov.it:specificheTecniche:sco:730
children	m730:EsitoIrpref m730:EsitoAddRegionale m730:EsitoAddComunale m730:PrimaRataAcclIrpref m730:SecondaRataAcclIrpref m730:AccontoTassSep m730:AccontoAddComunale m730:EsitoCedolareSecca m730:PrimaRataAccCedolare m730:SecondaRataAccCedolare m730:ContribSolidarietaDebito

element **Primo_Modulo_PL_Type/Prospetto/LiquidazioneImposte/EsitoIrpef**

diagram	<p>The diagram shows a dashed box labeled 'm730:EsitoIrpef' connected to a choice symbol (a circle with a vertical line and a plus sign). This choice symbol is connected to two boxes: 'm730:Credito' and 'm730:Debito'. Both boxes have a plus sign in the top right corner. The entire structure is enclosed in a larger dashed box labeled 'm730:Esito_Liquidazione_Type'.</p>
namespace	urn:www.agenziaentrate.gov.it:specificheTecniche:sco:730
type	m730:Esito_Liquidazione_Type
children	m730:Credito m730:Debito

element **Primo_Modulo_PL_Type/Prospetto/LiquidazioneImposte/EsitoAddRegionale**

diagram	<p>The diagram shows a dashed box labeled 'm730:EsitoAddRegionale' connected to a choice symbol. This choice symbol is connected to two boxes: 'm730:Credito' and 'm730:Debito'. Below this choice symbol, there is another choice symbol connected to a box labeled 'm730:CodAddReg'. The entire structure is enclosed in a larger dashed box labeled 'm730:Esito_Liquidazione_Type (extension)'.</p>
namespace	urn:www.agenziaentrate.gov.it:specificheTecniche:sco:730
type	extension of m730:Esito_Liquidazione_Type
children	m730:Credito m730:Debito m730:CodAddReg

element **Primo_Modulo_PL_Type/Prospetto/LiquidazioneImposte/EsitoAddRegionale/CodAddReg**

diagram	<p>The diagram shows a simple box labeled 'm730:CodAddReg' with a plus sign in the top right corner.</p>																																
namespace	urn:www.agenziaentrate.gov.it:specificheTecniche:sco:730																																
type	Codice Regione Type																																
facets	<table border="1"> <thead> <tr> <th>Kind</th> <th>Value</th> </tr> </thead> <tbody> <tr> <td>pattern</td> <td>(([0-9A-Z\-\]&quot;){1}([0-9A-Z&amp;] \- \., /° √\(\) À É É Ï Ò Ù Û &quot;; \\ / +)*</td> </tr> <tr> <td>enumeration</td> <td>1</td> </tr> <tr> <td>enumeration</td> <td>2</td> </tr> <tr> <td>enumeration</td> <td>3</td> </tr> <tr> <td>enumeration</td> <td>4</td> </tr> <tr> <td>enumeration</td> <td>5</td> </tr> <tr> <td>enumeration</td> <td>6</td> </tr> <tr> <td>enumeration</td> <td>7</td> </tr> <tr> <td>enumeration</td> <td>8</td> </tr> <tr> <td>enumeration</td> <td>9</td> </tr> <tr> <td>enumeration</td> <td>10</td> </tr> <tr> <td>enumeration</td> <td>11</td> </tr> <tr> <td>enumeration</td> <td>12</td> </tr> <tr> <td>enumeration</td> <td>13</td> </tr> <tr> <td>enumeration</td> <td>14</td> </tr> </tbody> </table>	Kind	Value	pattern	(([0-9A-Z\-\]"){1}([0-9A-Z&] \- \., /° √\(\) À É É Ï Ò Ù Û "; \\ / +)*	enumeration	1	enumeration	2	enumeration	3	enumeration	4	enumeration	5	enumeration	6	enumeration	7	enumeration	8	enumeration	9	enumeration	10	enumeration	11	enumeration	12	enumeration	13	enumeration	14
Kind	Value																																
pattern	(([0-9A-Z\-\]"){1}([0-9A-Z&] \- \., /° √\(\) À É É Ï Ò Ù Û "; \\ / +)*																																
enumeration	1																																
enumeration	2																																
enumeration	3																																
enumeration	4																																
enumeration	5																																
enumeration	6																																
enumeration	7																																
enumeration	8																																
enumeration	9																																
enumeration	10																																
enumeration	11																																
enumeration	12																																
enumeration	13																																
enumeration	14																																

	enumeration	15
	enumeration	16
	enumeration	17
	enumeration	18
	enumeration	19
	enumeration	20
	enumeration	21

element **Primo_Modulo_PL_Type/Prospetto/LiquidazioneImposte/EsitoAddComunale**

diagram	
namespace	urn:www.agenziaentrate.gov.it:specificheTecniche:sco:730
type	extension of m730:Esito_Liquidazione_Type
children	m730:Credito m730:Debito m730:CodiceAddCom

element **Primo_Modulo_PL_Type/Prospetto/LiquidazioneImposte/EsitoAddComunale/CodiceAddCom**

diagram					
namespace	urn:www.agenziaentrate.gov.it:specificheTecniche:sco:730				
type	DatoAN_Type				
facets	<table border="1"> <tr> <td>Kind</td> <td>Value</td> </tr> <tr> <td>pattern</td> <td>(([0-9A-Z-]&quot;){1}([0-9A-Z&amp;:] "- \., / "^\(\ \)\ À É È Ì Ò Ù Û &quot; \ \\ / +)*</td> </tr> </table>	Kind	Value	pattern	(([0-9A-Z-]"){1}([0-9A-Z&:] "- \., / "^\(\ \)\ À É È Ì Ò Ù Û " \ \\ / +)*
Kind	Value				
pattern	(([0-9A-Z-]"){1}([0-9A-Z&:] "- \., / "^\(\ \)\ À É È Ì Ò Ù Û " \ \\ / +)*				

element **Primo_Modulo_PL_Type/Prospetto/LiquidazioneImposte/PrimaRataAcclrpef**

diagram					
namespace	urn:www.agenziaentrate.gov.it:specificheTecniche:sco:730				
type	DatoNP_Type				
facets	<table border="1"> <tr> <td>Kind</td> <td>Value</td> </tr> <tr> <td>pattern</td> <td>[1-9]{1}[0-9]*</td> </tr> </table>	Kind	Value	pattern	[1-9]{1}[0-9]*
Kind	Value				
pattern	[1-9]{1}[0-9]*				

element **Primo_Modulo_PL_Type/Prospetto/LiquidazioneImposte/SecondaRataAcclrpef**

diagram	
namespace	urn:www.agenziaentrate.gov.it:specificheTecniche:sco:730

type	DatoNP_Type
facets	Kind Value pattern [1-9]{1}[0-9]*

element **Primo_Modulo_PL_Type/Prospetto/LiquidazioneImposte/AcontoTassSep**

diagram	
namespace	urn:www.agenziaentrate.gov.it:specificheTecniche:sco:730
type	m730:Debito_Type
children	m730:NonVersare m730:ImportoDaTrattenere

element **Primo_Modulo_PL_Type/Prospetto/LiquidazioneImposte/AcontoAddComunale**

diagram	
namespace	urn:www.agenziaentrate.gov.it:specificheTecniche:sco:730
children	m730:CodiceAddComAcconto m730:AccontoAddCom

element

Primo_Modulo_PL_Type/Prospetto/LiquidazioneImposte/AcontoAddComunale/CodiceAddComAcconto

diagram	
namespace	urn:www.agenziaentrate.gov.it:specificheTecniche:sco:730
type	DatoAN_Type
facets	Kind Value pattern ([0-9A-Z- "]{1}([0-9A-Z&] ' \" . / ° \"\\(\\) À É È Ì Ò Ù Û " \\\" \\+)*

element

Primo_Modulo_PL_Type/Prospetto/LiquidazioneImposte/AcontoAddComunale/AcontoAddCom

diagram	
namespace	urn:www.agenziaentrate.gov.it:specificheTecniche:sco:730
type	DatoNP_Type

facets	Kind pattern	Value [1-9]{1}[0-9]*
--------	-----------------	-------------------------

element **Primo_Modulo_PL_Type/Prospetto/LiquidazioneImposte/EsitoCedolareSecca**

diagram	
namespace	urn:www.agenziaentrate.gov.it:specificheTecniche:sco:730
type	m730:Esito Liquidazione Type
children	m730:Credito m730:Debito

element **Primo_Modulo_PL_Type/Prospetto/LiquidazioneImposte/PrimaRataAccCedolare**

diagram		
namespace	urn:www.agenziaentrate.gov.it:specificheTecniche:sco:730	
type	DatoNP_Type	
facets	Kind pattern	Value [1-9]{1}[0-9]*

element **Primo_Modulo_PL_Type/Prospetto/LiquidazioneImposte/SecondaRataAccCedolare**

diagram		
namespace	urn:www.agenziaentrate.gov.it:specificheTecniche:sco:730	
type	DatoNP_Type	
facets	Kind pattern	Value [1-9]{1}[0-9]*

element **Primo_Modulo_PL_Type/Prospetto/LiquidazioneImposte/ContribSolidarietaDebito**

diagram	
namespace	urn:www.agenziaentrate.gov.it:specificheTecniche:sco:730
type	m730:Debito_Type

children	m730:NonVersare m730:ImportoDaTrattenere
----------	--

element **Primo_Modulo_PL_Type/Prospetto/AltriDati**

diagram	
namespace	urn:www.agenziaentrate.gov.it:specificheTecniche:sco:730
type	m730:Altri_Dati_Type
children	m730:ResiduoCreditoErogazioneCultura m730:ResiduoCreditoPrimaCasa m730:ResiduoCreditoOccupazione m730:ResiduoCreditoSisma m730:ResiduoCreditoFondiPensione m730:ResiduoCreditoMediazioni m730:TotSpeseSanitarieRateizzate m730:RedditoAgevolazioniFiscali m730:RedditoComplessivoAcconto m730:RigoDifferenzaAcconto m730:RedditiFondiariniNonImponibili m730:RedditoAbitazionePrincipalePertinenze m730:ResiduoDeduzioneSommeRestituite m730:CreditoErogazioneCultura

element **Primo_Modulo_PL_Type/Prospetto/CredImpEstero**

diagram	
namespace	urn:www.agenziaentrate.gov.it:specificheTecniche:sco:730
type	m730:Cred Imp Estero Type
children	m730:Anno m730:TotCredito m730:CreditoStato

element **Primo_Modulo_PL_Type/Prospetto/DatiCreditiF24**

diagram	
---------	--

namespace	urn:www.agenziaentrate.gov.it:specificheTecniche:sco:730
type	m730:Crediti_F24_Type
children	m730:Credlrpef m730:CredlrpefDipNoSostituto m730:CodAddReg m730:CredAddReg m730:CredAddRegDipNoSostituto m730:CodiceAddCom m730:CredAddCom m730:CredAddComDipNoSostituto m730:CredCedolare m730:CredCedolareDipNoSostituto m730:CredTassSeparDipNoSostituto m730:CredSolidarietaDipNoSostituto m730:Totale m730:TotaleDipNoSostituto

element **Primo_Modulo_PL_Type/ProspettoRideterminato**

diagram	
namespace	urn:www.agenziaentrate.gov.it:specificheTecniche:sco:730
type	extension of m730:Prospetto_Type
children	m730:RiepilogoRedditi m730:ImpostaLorda m730:DetrazioniCrediti m730:ImpostaNetta m730:RedditoAgevolazioniFiscali

element **Primo_Modulo_PL_Type/ProspettoRideterminato/RedditoAgevolazioniFiscali**

diagram					
namespace	urn:www.agenziaentrate.gov.it:specificheTecniche:sco:730				
type	DatoNP_Type				
facets	<table border="1"> <thead> <tr> <th>Kind</th> <th>Value</th> </tr> </thead> <tbody> <tr> <td>pattern</td> <td>[1-9]{1}[0-9]*</td> </tr> </tbody> </table>	Kind	Value	pattern	[1-9]{1}[0-9]*
Kind	Value				
pattern	[1-9]{1}[0-9]*				

complexType **Prospetto_Annotazioni_Type**

diagram	
namespace	urn:www.agenziaentrate.gov.it:specificheTecniche:sco:730
children	m730:Modulo_Annotazioni

element **Prospetto_Annotazioni_Type/Modulo_Annotazioni**

diagram	
namespace	urn:www.agenziaentrate.gov.it:specificheTecniche:sco:730
type	m730:Modulo_Annotazioni_Type
children	m730:Annotazione

complexType **Prospetto_Liquidazione_Type**

diagram	
namespace	urn:www.agenziaentrate.gov.it:specificheTecniche:sco:730
children	m730:PrimoModulo m730:Modulo

element **Prospetto_Liquidazione_Type/PrimoModulo**

diagram	
namespace	urn:www.agenziaentrate.gov.it:specificheTecniche:sco:730
type	m730:Primo_Modulo_PL_Type
children	m730:Prospetto m730:ProspettoRideterminato

element **Prospetto_Liquidazione_Type/Modulo**

diagram	
namespace	urn:www.agenziaentrate.gov.it:specificheTecniche:sco:730
type	m730:Modulo_PL_Type

children	m730:CredImpEstero
----------	------------------------------------

complexType **Prospetto_Type**

diagram	<p>The diagram shows a complexType named Prospetto_Type on the left, connected to a container element (a rounded rectangle with a dashed border and three dots) on the right. This container element is connected to four child elements, each in a dashed box with a plus sign: m730:RiepilogoRedditi, m730:ImpostaLorda, m730:DetrazioniCrediti, and m730:ImpostaNetta.</p>
namespace	urn:www.agenziaentrate.gov.it:specificheTecniche:sco:730
children	m730:RiepilogoRedditi m730:ImpostaLorda m730:DetrazioniCrediti m730:ImpostaNetta

element **Prospetto_Type/RiepilogoRedditi**

diagram	<p>The diagram shows an element named m730:RiepilogoRedditi on the left, connected to a container element (a rounded rectangle with a dashed border and three dots) on the right. This container element is connected to nine child elements, each in a dashed box with a plus sign. These child elements are grouped within a larger dashed box labeled m730:Riepilogo_Redditi_Type. The child elements are: m730:Dominicali, m730:Agrari, m730:Fabbricati, m730:LavDip, m730:AltriRedditi, m730:ImponibileCedolare, m730:ImponibileCedolareOrdina..., m730:ImponibileCedolareAgevo..., and m730:AbitazionePrincipalePertin....</p>
namespace	urn:www.agenziaentrate.gov.it:specificheTecniche:sco:730
type	m730:Riepilogo_Redditi_Type
children	m730:Dominicali m730:Agrari m730:Fabbricati m730:LavDip m730:AltriRedditi m730:ImponibileCedolare m730:ImponibileCedolareOrdinario m730:ImponibileCedolareAgevolato m730:AbitazionePrincipalePertinenze

element **Prospetto_Type/ImpostaLorda**

<p>diagram</p>	<pre> classDiagram class m730:ImpostaLorda class m730:Imposta_Lorda_Type class m730:RedditoComplessivo class m730:DeduzioneAbitazPrincipale class m730:OneriDeducibili class m730:RedditoImponibile class m730:CompensiAttSport class m730:ImportoImpostaLorda m730:ImpostaLorda "1" *-- "1" m730:Imposta_Lorda_Type m730:Imposta_Lorda_Type "1" *-- "1" m730:RedditoComplessivo m730:Imposta_Lorda_Type "1" *-- "1" m730:DeduzioneAbitazPrincipale m730:Imposta_Lorda_Type "1" *-- "1" m730:OneriDeducibili m730:Imposta_Lorda_Type "1" *-- "1" m730:RedditoImponibile m730:Imposta_Lorda_Type "1" *-- "1" m730:CompensiAttSport m730:Imposta_Lorda_Type "1" *-- "1" m730:ImportoImpostaLorda </pre>
<p>namespace</p>	<p>urn:www.agenziaentrato.gov.it:specificheTecniche:sco:730</p>
<p>type</p>	<p>m730:Imposta_Lorda_Type</p>
<p>children</p>	<p>m730:RedditoComplessivo m730:DeduzioneAbitazPrincipale m730:OneriDeducibili m730:RedditoImponibile m730:CompensiAttSport m730:ImportoImpostaLorda</p>

element **Prospetto_Type/DetrazioniCrediti**

<p>diagram</p>	
<p>namespace</p>	<p>urn:www.agenziaentrate.gov.it:specificheTecniche:sco:730</p>
<p>type</p>	<p>m730:Detrazione_Crediti_Type</p>
<p>children</p>	<p>m730:DetrazioneConiuge m730:DetrazioneFigli m730:UlterioreDetrazioneFigli m730:DetrazioneFamiliari m730:DetrazioneLavDip m730:DetrazionePens m730:DetrazioneAltriRedditi m730:DetrazioneOneri m730:DetrazioneRistrutturazione m730:DetrazioniArredolmmobili m730:DetrazioneRisparmioEnergetico m730:DetrazioneLocEAgricoliGiovani m730:AltreDetrazioni m730:CreditoPrimaCasa m730:CreditoOccupazione m730:CreditoFondiPensione m730:CreditoMediazioni m730:CreditoNegoziazione m730:TotaleDetrazioniCrediti</p>

element **Prospetto_Type/ImpostaNetta**

<p>diagram</p>	
<p>namespace</p>	<p>urn:www.agenziaentrate.gov.it:specificheTecniche:sco:730</p>
<p>type</p>	<p>m730:Imposta_Netta_Type</p>
<p>children</p>	<p>m730:ImportoImpostaNetta m730:CredAltriSisma m730:CredAbitazSisma m730:CredImpEstere m730:CredErogCultura m730:CredCanNonPerc m730:CredDetrazIncapienti m730:Ritenute m730:Differenza m730:EccedenzaIrpef m730:AccontiVersati m730:RestituzioneBonus m730:CredRimborsatiSost m730:BonusIrpefSpettante m730:BonusIrpefRiconosciuto m730:RestituzioneBonusIrpef</p>

complexType Quadro_I_Type

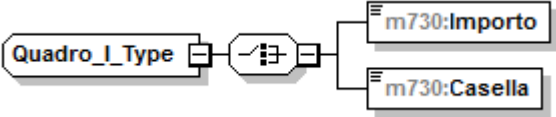
diagram	
namespace	urn:www.agenziaentrate.gov.it:specificheTecniche:sco:730
children	m730:Importo m730:Casella

element Quadro_I_Type/Importo

diagram					
namespace	urn:www.agenziaentrate.gov.it:specificheTecniche:sco:730				
type	DatoNP_Type				
facets	<table border="1"> <thead> <tr> <th>Kind</th> <th>Value</th> </tr> </thead> <tbody> <tr> <td>pattern</td> <td>[1-9]{1}[0-9]*</td> </tr> </tbody> </table>	Kind	Value	pattern	[1-9]{1}[0-9]*
Kind	Value				
pattern	[1-9]{1}[0-9]*				

element Quadro_I_Type/Casella

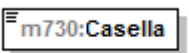
diagram					
namespace	urn:www.agenziaentrate.gov.it:specificheTecniche:sco:730				
type	DatoCB_Type				
facets	<table border="1"> <thead> <tr> <th>Kind</th> <th>Value</th> </tr> </thead> <tbody> <tr> <td>pattern</td> <td>[01]</td> </tr> </tbody> </table>	Kind	Value	pattern	[01]
Kind	Value				
pattern	[01]				

complexType Quadro_K_Type

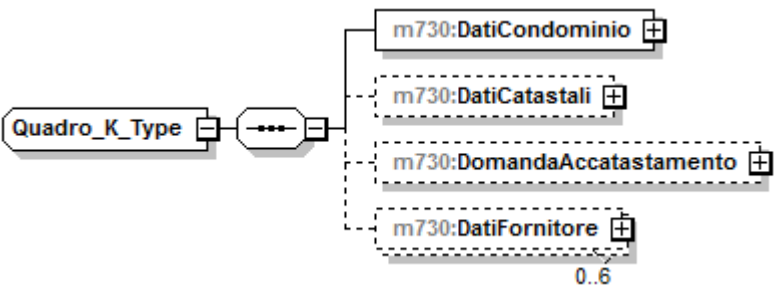
diagram	
namespace	urn:www.agenziaentrate.gov.it:specificheTecniche:sco:730
children	m730:DatiCondominio m730:DatiCatastali m730:DomandaAccatastamento m730:DatiFornitore

element **Quadro_K_Type/DatiCondominio**

diagram	
namespace	urn:www.agenziaentrate.gov.it:specificheTecniche:sco:730
type	m730:Dati_Condominio_Type
children	m730:CodiceFiscale m730:Denominazione

element **Quadro_K_Type/DatiCatastali**

diagram	
namespace	urn:www.agenziaentrate.gov.it:specificheTecniche:sco:730
type	m730:Dati_Catastali_Type
children	m730:CodiceComune m730:TerreniUrbano m730:SezioneUrbanaComuneCatastale m730:Foglio m730:Particella m730:Subalterno

element **Quadro_K_Type/DomandaAccatastamento**

diagram	
namespace	urn:www.agenziaentrate.gov.it:specificheTecniche:sco:730

type	m730:Domanda Accatastamento Type
children	m730:Data m730:Numero m730:ProvinciaUfficio

element **Quadro_K_Type/DatiFornitore**

diagram	
namespace	urn:www.agenziaentrate.gov.it:specificheTecniche:sco:730
type	m730:Dati Fornitore Type
children	m730:CodiceFiscale m730:CognomeDenom m730:Nome m730:Sesso m730:DataNascita m730:ComuneNascita m730:ProvinciaNascita m730:ImportoAcquisti

complexType **Rappresentante_Type**

diagram	
namespace	urn:www.agenziaentrate.gov.it:specificheTecniche:sco:730
children	m730:SoggettoFiscale m730:DatiAnagrafici m730:ResidenzaAnagrafica m730:Firma

element **Rappresentante_Type/SoggettoFiscale**

diagram	
namespace	urn:www.agenziaentrate.gov.it:specificheTecniche:sco:730
type	m730:Soggetto_Fiscale_730_Type
children	m730:CodiceFiscale m730:Email m730:Telefono m730:Cellulare

element **Rappresentante_Type/DatiAnagrafici**

diagram	
namespace	urn:www.agenziaentrate.gov.it:specificheTecniche:sco:730
type	Dati_Anagrafici_Type
children	Cognome Nome Sesso DataNascita ComuneNascita ProvinciaNascita

element **Rappresentante_Type/ResidenzaAnagrafica**

diagram	
namespace	urn:www.agenziaentrate.gov.it:specificheTecniche:sco:730
type	m730:Residenza_Rappresentante_Type
children	Comune Provincia CodiceComune Indirizzo Cap m730:Tipologia m730:NumCivico m730:Frazione

element **Rappresentante_Type/Firma**

diagram					
namespace	urn:www.agenziaentrate.gov.it:specificheTecniche:sco:730				
type	DatoCB_Type				
facets	<table border="1"> <thead> <tr> <th>Kind</th> <th>Value</th> </tr> </thead> <tbody> <tr> <td>pattern</td> <td>[01]</td> </tr> </tbody> </table>	Kind	Value	pattern	[01]
Kind	Value				
pattern	[01]				

complexType **Redditi_Capitale_Type**

diagram	
namespace	urn:www.agenziaentrate.gov.it:specificheTecniche:sco:730

children	m730:Utili m730:AltriRedditiDiCapitale m730:LavoroAutonomo m730:RedditiDiversi m730:RedditiDiversiDetraz
----------	--

element **Redditi_Capitale_Type/Utili**

diagram	
namespace	urn:www.agenziaentrate.gov.it:specificheTecniche:sco:730
type	m730:Altri_Redditi_Utili_Type
children	m730:Tipo_Reddito m730:RedditiRitenute

element **Redditi_Capitale_Type/AltriRedditiDiCapitale**

diagram	
namespace	urn:www.agenziaentrate.gov.it:specificheTecniche:sco:730
type	m730:Sezione_Altri_Redd_Type
children	m730:TipoReddito m730:RedditiRitenute

element **Redditi_Capitale_Type/LavoroAutonomo**

diagram	
namespace	urn:www.agenziaentrate.gov.it:specificheTecniche:sco:730
type	m730:Altri_Redditi_Lavoro_Autonomo_Type
children	m730:TipoReddito m730:RedditiRitenute

element **Redditi_Capitale_Type/RedditiDiversi**

diagram	
namespace	urn:www.agenziaentrate.gov.it:specificheTecniche:sco:730
type	m730:Altri_Redditi_Diversi_Type
children	m730:TipoReddito m730:RedditiRitenuteSpese

element **Redditi_Capitale_Type/RedditiDiversiDetraz**

diagram	
namespace	urn:www.agenziaentrate.gov.it:specificheTecniche:sco:730
type	m730:Altri_Redditi_Diversi_Detr_Type
children	m730:Tipo_Reddito m730:RedditiRitenuteSpese

complexType **Redditi_Eredi_Legatari_Type**

diagram	
namespace	urn:www.agenziaentrate.gov.it:specificheTecniche:sco:730
type	extension of m730:Tassazione_Separata_Type
children	m730:Opzione m730:Anno m730:RedditoRitenute m730:TipoReddito m730:RedditoTotale m730:QuotaImposteSuccessioni

	m730:QuotalmposteSuccessioni
--	--

element **Redditi_Eredi_Legatari_Type/TipoReddito**

diagram																													
namespace	urn:www.agenziaentrate.gov.it:specificheTecniche:sco:730																												
type	m730:Tipo_Redito_Da1a12_Type																												
facets	<table border="1"> <thead> <tr> <th>Kind</th> <th>Value</th> </tr> </thead> <tbody> <tr> <td>pattern</td> <td>[1-9]{1}[0-9]*</td> </tr> <tr> <td>enumeration</td> <td>1</td> </tr> <tr> <td>enumeration</td> <td>2</td> </tr> <tr> <td>enumeration</td> <td>3</td> </tr> <tr> <td>enumeration</td> <td>4</td> </tr> <tr> <td>enumeration</td> <td>5</td> </tr> <tr> <td>enumeration</td> <td>6</td> </tr> <tr> <td>enumeration</td> <td>7</td> </tr> <tr> <td>enumeration</td> <td>8</td> </tr> <tr> <td>enumeration</td> <td>9</td> </tr> <tr> <td>enumeration</td> <td>10</td> </tr> <tr> <td>enumeration</td> <td>11</td> </tr> <tr> <td>enumeration</td> <td>12</td> </tr> </tbody> </table>	Kind	Value	pattern	[1-9]{1}[0-9]*	enumeration	1	enumeration	2	enumeration	3	enumeration	4	enumeration	5	enumeration	6	enumeration	7	enumeration	8	enumeration	9	enumeration	10	enumeration	11	enumeration	12
Kind	Value																												
pattern	[1-9]{1}[0-9]*																												
enumeration	1																												
enumeration	2																												
enumeration	3																												
enumeration	4																												
enumeration	5																												
enumeration	6																												
enumeration	7																												
enumeration	8																												
enumeration	9																												
enumeration	10																												
enumeration	11																												
enumeration	12																												

element **Redditi_Eredi_Legatari_Type/RedditoTotale**

diagram					
namespace	urn:www.agenziaentrate.gov.it:specificheTecniche:sco:730				
type	DatoNP_Type				
facets	<table border="1"> <thead> <tr> <th>Kind</th> <th>Value</th> </tr> </thead> <tbody> <tr> <td>pattern</td> <td>[1-9]{1}[0-9]*</td> </tr> </tbody> </table>	Kind	Value	pattern	[1-9]{1}[0-9]*
Kind	Value				
pattern	[1-9]{1}[0-9]*				

element **Redditi_Eredi_Legatari_Type/QuotalmposteSuccessioni**

diagram					
namespace	urn:www.agenziaentrate.gov.it:specificheTecniche:sco:730				
type	DatoNP_Type				
facets	<table border="1"> <thead> <tr> <th>Kind</th> <th>Value</th> </tr> </thead> <tbody> <tr> <td>pattern</td> <td>[1-9]{1}[0-9]*</td> </tr> </tbody> </table>	Kind	Value	pattern	[1-9]{1}[0-9]*
Kind	Value				
pattern	[1-9]{1}[0-9]*				

complexType **Redditi_Fabbricati_Type**

diagram	
namespace	urn:www.agenziaentrate.gov.it:specificheTecniche:sco:730
children	m730:Modulo

element **Redditi_Fabbricati_Type/Modulo**

diagram	
namespace	urn:www.agenziaentrate.gov.it:specificheTecniche:sco:730
type	m730:Modulo_Fabbricato_Type
children	m730:FabbricatoOrd m730:FabbricatoAgev

complexType **Redditi_Lavoro_Dip_Type**

diagram	
namespace	urn:www.agenziaentrate.gov.it:specificheTecniche:sco:730
children	m730:PrimoModulo m730:Modulo

element **Redditi_Lavoro_Dip_Type/PrimoModulo**

<p>diagram</p>	
<p>namespace</p>	<p>urn:www.agenziaentrate.gov.it:specificheTecniche:sco:730</p>
<p>type</p>	<p>m730:Primo_Modulo_Lavoro_Dip_Type</p>
<p>children</p>	<p>m730:LavoroDipendente m730:PeriodoLavoro m730:AltriRedditiAssLavDip m730:RitenuteLavoroDipendente m730:Bonuslrpef m730:RedditoAlNettoContribPensioni m730:ContribSolidarietaTrattenuto m730:CasellaCasiParticolari</p>

element **Redditi_Lavoro_Dip_Type/Modulo**

<p>diagram</p>	
<p>namespace</p>	<p>urn:www.agenziaentrate.gov.it:specificheTecniche:sco:730</p>
<p>type</p>	<p>m730:Modulo_Lavoro_Dip_Type</p>
<p>children</p>	<p>m730:LavoroDipendente m730:AltriRedditiAssLavDip m730:Bonuslrpef</p>

complexType **Redditi_Ritenute_Spese_Type**

diagram	
namespace	urn:www.agenziaentrate.gov.it:specificheTecniche:sco:730
type	extension of m730:Redditi_Ritenute_Type
children	m730:ImportoRedditi m730:ImportoRitenute m730:ImportoSpese

element **Redditi_Ritenute_Spese_Type/ImportoSpese**

diagram					
namespace	urn:www.agenziaentrate.gov.it:specificheTecniche:sco:730				
type	DatoNP_Type				
facets	<table border="1"> <thead> <tr> <th>Kind</th> <th>Value</th> </tr> </thead> <tbody> <tr> <td>pattern</td> <td>[1-9]{1}[0-9]*</td> </tr> </tbody> </table>	Kind	Value	pattern	[1-9]{1}[0-9]*
Kind	Value				
pattern	[1-9]{1}[0-9]*				

complexType **Redditi_Ritenute_Type**

diagram	
namespace	urn:www.agenziaentrate.gov.it:specificheTecniche:sco:730
children	m730:ImportoRedditi m730:ImportoRitenute

element **Redditi_Ritenute_Type/ImportoRedditi**

diagram					
namespace	urn:www.agenziaentrate.gov.it:specificheTecniche:sco:730				
type	DatoNP_Type				
facets	<table border="1"> <thead> <tr> <th>Kind</th> <th>Value</th> </tr> </thead> <tbody> <tr> <td>pattern</td> <td>[1-9]{1}[0-9]*</td> </tr> </tbody> </table>	Kind	Value	pattern	[1-9]{1}[0-9]*
Kind	Value				
pattern	[1-9]{1}[0-9]*				

element **Redditi_Ritenute_Type/ImportoRitenute**

diagram	
namespace	urn:www.agenziaentrate.gov.it:specificheTecniche:sco:730
type	DatoNP_Type
facets	Kind Value pattern [1-9]{1}[0-9]*

complexType **Redditi_Tassazione_Separata_Type**

diagram	
namespace	urn:www.agenziaentrate.gov.it:specificheTecniche:sco:730
children	m730:RedditiErede m730:ImposteRimborsate

element **Redditi_Tassazione_Separata_Type/RedditiErede**

diagram	
namespace	urn:www.agenziaentrate.gov.it:specificheTecniche:sco:730
type	m730:Redditi Eredi Legatari Type
children	m730:Opzione m730:Anno m730:RedditoRitenute m730:TipoReddito m730:RedditoTotale m730:QuotaImposteSuccessioni

element **Redditi_Tassazione_Separata_Type/ImposteRimborsate**

diagram	
namespace	urn:www.agenziaentrate.gov.it:specificheTecniche:sco:730
type	m730:Imposte_Rimborsate_Type
children	m730:TipoReddito m730:TassazioneSeparata

complexType **Redditi_Terreni_Type**

diagram	
namespace	urn:www.agenziaentrate.gov.it:specificheTecniche:sco:730
children	m730:Modulo

element **Redditi_Terreni_Type/Modulo**

diagram	
namespace	urn:www.agenziaentrate.gov.it:specificheTecniche:sco:730
type	m730:Modulo_Terreno_Type
children	m730:Terreno

complexType **Reddito_Erede_Type**

diagram	
namespace	urn:www.agenziaentrate.gov.it:specificheTecniche:sco:730

type	extension of m730:Tassazione Separata Type
children	m730:Opzione m730:Anno m730:RedditoRitenute

complexType [Residenza_Anagrafica_730_Type](#)

diagram	
namespace	urn:www.agenziaentrate.gov.it:specificheTecniche:sco:730
type	extension of Residenza_Anagrafica_Type
children	Comune Provincia CodiceComune Indirizzo Cap DataVariazione m730:Tipologia m730:NumCivico m730:Frazione m730:PrimaPresentazione

element [Residenza_Anagrafica_730_Type/Tipologia](#)

diagram					
namespace	urn:www.agenziaentrate.gov.it:specificheTecniche:sco:730				
type	DatoAN_Type				
facets	<table border="1"> <tr> <td>Kind</td> <td>Value</td> </tr> <tr> <td>pattern</td> <td>(([0-9A-Z-] \&quot;){1}([0-9A-Z&amp;] '\ - \., / ° °\ (\)À È É Ì Ò Ù Ü &quot; \ \\ \ +)*</td> </tr> </table>	Kind	Value	pattern	(([0-9A-Z-] \"){1}([0-9A-Z&] '\ - \., / ° °\ (\)À È É Ì Ò Ù Ü " \ \\ \ +)*
Kind	Value				
pattern	(([0-9A-Z-] \"){1}([0-9A-Z&] '\ - \., / ° °\ (\)À È É Ì Ò Ù Ü " \ \\ \ +)*				

element [Residenza_Anagrafica_730_Type/NumCivico](#)

diagram	
---------	--

namespace	urn:www.agenziaentrate.gov.it:specificheTecniche:sco:730
type	DatoAN_Type
facets	Kind Value pattern ([0-9A-Z\-\"]{1})([0-9A-Z&:] ' - \., / ° '¥\(\)\ À É È Ì Ò Ù Ú " \ \\ \ +)*

element **Residenza_Anagrafica_730_Type/Frazione**

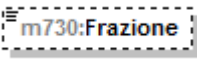
diagram	
namespace	urn:www.agenziaentrate.gov.it:specificheTecniche:sco:730
type	DatoAN_Type
facets	Kind Value pattern ([0-9A-Z\-\"]{1})([0-9A-Z&:] ' - \., / ° '¥\(\)\ À É È Ì Ò Ù Ú " \ \\ \ +)*

element **Residenza_Anagrafica_730_Type/PrimaPresentazione**

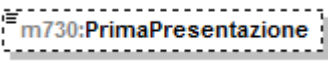
diagram	
namespace	urn:www.agenziaentrate.gov.it:specificheTecniche:sco:730
type	DatoCB_Type
facets	Kind Value pattern [01]

complexType **Residenza_Rappresentante_Type**

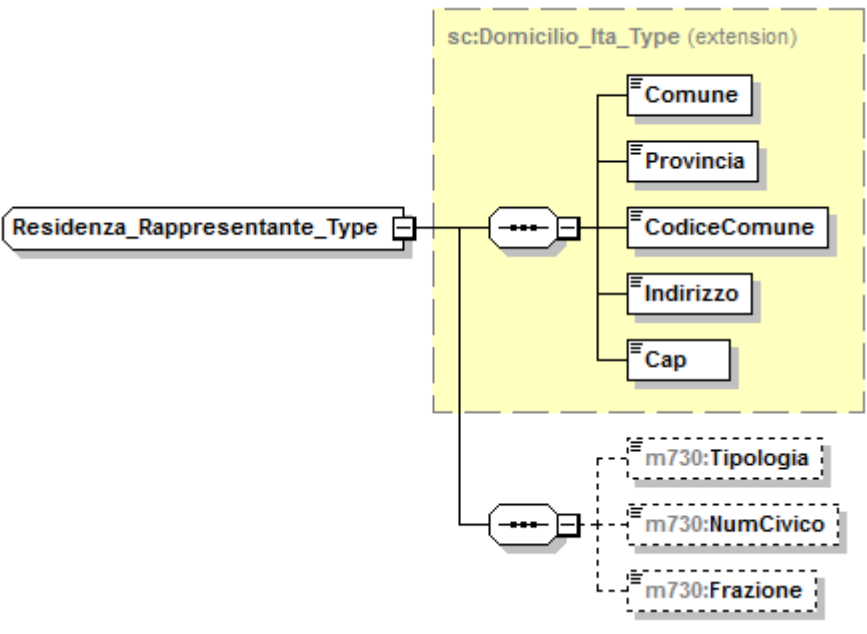
diagram	 <p>The diagram illustrates the structure of the Residenza_Rappresentante_Type complex type. It is an extension of the sc:Domicilio_Ita_Type (highlighted in a yellow dashed box). The extension includes the following elements:</p> <ul style="list-style-type: none"> Comune (required field) Provincia (required field) CodiceComune (required field) Indirizzo (required field) Cap (required field) m730:Tipologia (optional field, shown in a dashed box) m730:NumCivico (optional field, shown in a dashed box) m730:Frazione (optional field, shown in a dashed box)
namespace	urn:www.agenziaentrate.gov.it:specificheTecniche:sco:730
type	extension of Domicilio_Ita_Type

children	Comune Provincia CodiceComune Indirizzo Cap m730:Tipologia m730:NumCivico m730:Frazione
----------	---

element **Residenza_Rappresentante_Type/Tipologia**

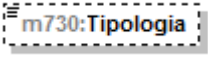
diagram	
namespace	urn:www.agenziaentrate.gov.it:specificheTecniche:sco:730
type	DatoAN_Type
facets	Kind Value pattern ([0-9A-Z-]*)"){1}([0-9A-Z&:] "- \., / "^\(\) \) À É È Ì Ò Ù Ü " \ \ \+)*

element **Residenza_Rappresentante_Type/NumCivico**

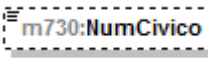
diagram	
namespace	urn:www.agenziaentrate.gov.it:specificheTecniche:sco:730
type	DatoAN_Type
facets	Kind Value pattern ([0-9A-Z-]*)"){1}([0-9A-Z&:] "- \., / "^\(\) \) À É È Ì Ò Ù Ü " \ \ \+)*

element **Residenza_Rappresentante_Type/Frazione**

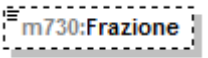
diagram	
namespace	urn:www.agenziaentrate.gov.it:specificheTecniche:sco:730
type	DatoAN_Type
facets	Kind Value pattern ([0-9A-Z-]*)"){1}([0-9A-Z&:] "- \., / "^\(\) \) À É È Ì Ò Ù Ü " \ \ \+)*

namespace	urn:www.agenziaentrate.gov.it:specificheTecniche:sco:730
type	DatoAN_Type
facets	Kind Value pattern ([0-9A-Z\-\-]"){1}([0-9A-Z&:] ' - \., / ^*\(\ \) À É È Ì Ò Ù Ü " \ \ \ +)*

element **Residenza_Type/Cap**

diagram	
namespace	urn:www.agenziaentrate.gov.it:specificheTecniche:sco:730
type	DatoAN_Type
facets	Kind Value pattern ([0-9A-Z\-\-]"){1}([0-9A-Z&:] ' - \., / ^*\(\ \) À É È Ì Ò Ù Ü " \ \ \ +)*

element **Residenza_Type/Tipologia**

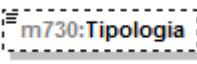
diagram	
namespace	urn:www.agenziaentrate.gov.it:specificheTecniche:sco:730
type	DatoAN_Type
facets	Kind Value pattern ([0-9A-Z\-\-]"){1}([0-9A-Z&:] ' - \., / ^*\(\ \) À É È Ì Ò Ù Ü " \ \ \ +)*

element **Residenza_Type/Indirizzo**

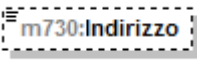
diagram	
namespace	urn:www.agenziaentrate.gov.it:specificheTecniche:sco:730
type	DatoAN_Type
facets	Kind Value pattern ([0-9A-Z\-\-]"){1}([0-9A-Z&:] ' - \., / ^*\(\ \) À É È Ì Ò Ù Ü " \ \ \ +)*

element **Residenza_Type/NumCivico**

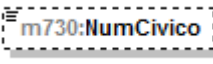
diagram	
namespace	urn:www.agenziaentrate.gov.it:specificheTecniche:sco:730
type	DatoAN_Type
facets	Kind Value pattern ([0-9A-Z\-\-]"){1}([0-9A-Z&:] ' - \., / ^*\(\ \) À É È Ì Ò Ù Ü " \ \ \ +)*

element **Residenza_Type/Frazione**

diagram	
namespace	urn:www.agenziaentrate.gov.it:specificheTecniche:sco:730
type	DatoAN_Type
facets	Kind Value pattern ([0-9A-Z-] \"){1}([0-9A-Z&] '\- \., /'°\^\(\)\ À É È Ì Ò Ù Ü " \ \\ \ +)*

element **Residenza_Type/Email**

diagram	
namespace	urn:www.agenziaentrate.gov.it:specificheTecniche:sco:730
type	DatoEM_Type
facets	Kind Value pattern [a-zA-Z0-9._%\-'\"?^~=]+@[a-zA-Z0-9.\-]+\.[a-zA-Z]{2,4}

element **Residenza_Type/Telefono**

diagram	
namespace	urn:www.agenziaentrate.gov.it:specificheTecniche:sco:730
type	DatoAN_Type
facets	Kind Value pattern ([0-9A-Z-] \"){1}([0-9A-Z&] '\- \., /'°\^\(\)\ À É È Ì Ò Ù Ü " \ \\ \ +)*

complexType **Residuo_Credito_Compens_Annolmposta_Type**

diagram	
namespace	urn:www.agenziaentrate.gov.it:specificheTecniche:sco:730
type	extension of m730:Residuo_Credito_Compens_Type
children	m730:CreditoAnno m730:DiCuiCompensatoF24

complexType **Residuo_Credito_Compens_Type**

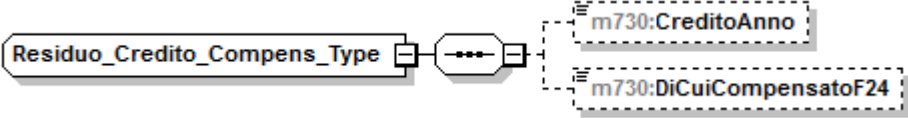
diagram	
namespace	urn:www.agenziaentrate.gov.it:specificheTecniche:sco:730
children	m730:CreditoAnno m730:DiCuiCompensatoF24

element **Residuo_Credito_Compens_Type/CreditoAnno**

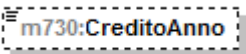
diagram					
namespace	urn:www.agenziaentrate.gov.it:specificheTecniche:sco:730				
type	DatoNP_Type				
facets	<table border="1"> <tr> <td>Kind</td> <td>Value</td> </tr> <tr> <td>pattern</td> <td>[1-9]{1}[0-9]*</td> </tr> </table>	Kind	Value	pattern	[1-9]{1}[0-9]*
Kind	Value				
pattern	[1-9]{1}[0-9]*				

element **Residuo_Credito_Compens_Type/DiCuiCompensatoF24**

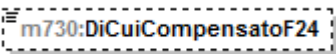
diagram					
namespace	urn:www.agenziaentrate.gov.it:specificheTecniche:sco:730				
type	DatoNP_Type				
facets	<table border="1"> <tr> <td>Kind</td> <td>Value</td> </tr> <tr> <td>pattern</td> <td>[1-9]{1}[0-9]*</td> </tr> </table>	Kind	Value	pattern	[1-9]{1}[0-9]*
Kind	Value				
pattern	[1-9]{1}[0-9]*				

complexType **Residuo_Fabbricati_Type**

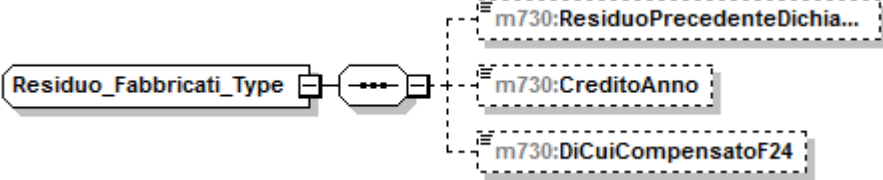
diagram	
namespace	urn:www.agenziaentrate.gov.it:specificheTecniche:sco:730
children	m730:ResiduoPrecedenteDichiarazione m730:CreditoAnno m730:DiCuiCompensatoF24

element **Residuo_Fabbricati_Type/ResiduoPrecedenteDichiarazione**

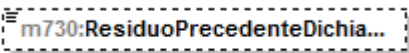
diagram	
namespace	urn:www.agenziaentrate.gov.it:specificheTecniche:sco:730
type	DatoNP_Type

facets	Kind pattern	Value [1-9]{1}[0-9]*
--------	-----------------	-------------------------

element **Residuo_Fabbricati_Type/CreditoAnno**

diagram		
namespace	urn:www.agenziaentrate.gov.it:specificheTecniche:sco:730	
type	DatoNP_Type	
facets	Kind pattern	Value [1-9]{1}[0-9]*

element **Residuo_Fabbricati_Type/DiCuiCompensatoF24**

diagram		
namespace	urn:www.agenziaentrate.gov.it:specificheTecniche:sco:730	
type	DatoNP_Type	
facets	Kind pattern	Value [1-9]{1}[0-9]*

complexType **Restituzione_Somme_Type**

diagram		
namespace	urn:www.agenziaentrate.gov.it:specificheTecniche:sco:730	
children	m730:SommeRestituite m730:ResiduoPrecedenteDic	

element **Restituzione_Somme_Type/SommeRestituite**

diagram		
namespace	urn:www.agenziaentrate.gov.it:specificheTecniche:sco:730	
type	DatoNP_Type	
facets	Kind pattern	Value [1-9]{1}[0-9]*

element **Restituzione_Somme_Type/ResiduoPrecedenteDic**

diagram		
namespace	urn:www.agenziaentrate.gov.it:specificheTecniche:sco:730	

type	DatoNP_Type
facets	Kind Value pattern [1-9]{1}[0-9]*

complexType Rettifica_Type

diagram	
namespace	urn:www.agenziaentrate.gov.it:specificheTecniche:sco:730
children	m730:Quadro m730:Rigo m730:Colonna m730:Modulo m730:DatoRimosso

element Rettifica_Type/Quadro

diagram	
namespace	urn:www.agenziaentrate.gov.it:specificheTecniche:sco:730
type	DatoAN_Type
facets	Kind Value pattern ([0-9A-Z\-_]"){1}([0-9A-Z&#39; ! - \., / ° °\(\) À É È Ì Ò Ù Ú " \ \\ \ +)*

element Rettifica_Type/Rigo

diagram	
namespace	urn:www.agenziaentrate.gov.it:specificheTecniche:sco:730
type	DatoNP_Type
facets	Kind Value pattern [1-9]{1}[0-9]*

element Rettifica_Type/Colonna

diagram	
namespace	urn:www.agenziaentrate.gov.it:specificheTecniche:sco:730
type	DatoNP_Type
facets	Kind Value pattern [1-9]{1}[0-9]*

element **Rettifica_Type/Modulo**

diagram	
namespace	urn:www.agenziaentrate.gov.it:specificheTecniche:sco:730
type	DatoNP_Type
facets	Kind Value pattern [1-9]{1}[0-9]*

element **Rettifica_Type/DatoRimosso**

diagram	
namespace	urn:www.agenziaentrate.gov.it:specificheTecniche:sco:730
type	DatoCB_Type
facets	Kind Value pattern [01]

complexType **Riepilogo_Redditi_Type**

diagram	
namespace	urn:www.agenziaentrate.gov.it:specificheTecniche:sco:730
children	m730:Dominicali m730:Agrari m730:Fabbricati m730:LavDip m730:AltriRedditi m730:ImponibileCedolare m730:ImponibileCedolareOrdinario m730:ImponibileCedolareAgevolato m730:AbitazionePrincipalePertinenze

element **Riepilogo_Reddito_Type/Dominicali**

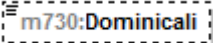
diagram					
namespace	urn:www.agenziaentrate.gov.it:specificheTecniche:sco:730				
type	DatoNP_Type				
facets	<table border="1"> <tr> <td>Kind</td> <td>Value</td> </tr> <tr> <td>pattern</td> <td>[1-9]{1}[0-9]*</td> </tr> </table>	Kind	Value	pattern	[1-9]{1}[0-9]*
Kind	Value				
pattern	[1-9]{1}[0-9]*				

element **Riepilogo_Reddito_Type/Agrari**

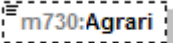
diagram					
namespace	urn:www.agenziaentrate.gov.it:specificheTecniche:sco:730				
type	DatoNP_Type				
facets	<table border="1"> <tr> <td>Kind</td> <td>Value</td> </tr> <tr> <td>pattern</td> <td>[1-9]{1}[0-9]*</td> </tr> </table>	Kind	Value	pattern	[1-9]{1}[0-9]*
Kind	Value				
pattern	[1-9]{1}[0-9]*				

element **Riepilogo_Reddito_Type/Fabbricati**

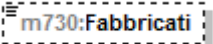
diagram					
namespace	urn:www.agenziaentrate.gov.it:specificheTecniche:sco:730				
type	DatoNP_Type				
facets	<table border="1"> <tr> <td>Kind</td> <td>Value</td> </tr> <tr> <td>pattern</td> <td>[1-9]{1}[0-9]*</td> </tr> </table>	Kind	Value	pattern	[1-9]{1}[0-9]*
Kind	Value				
pattern	[1-9]{1}[0-9]*				

element **Riepilogo_Reddito_Type/LavDip**

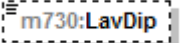
diagram					
namespace	urn:www.agenziaentrate.gov.it:specificheTecniche:sco:730				
type	DatoNP_Type				
facets	<table border="1"> <tr> <td>Kind</td> <td>Value</td> </tr> <tr> <td>pattern</td> <td>[1-9]{1}[0-9]*</td> </tr> </table>	Kind	Value	pattern	[1-9]{1}[0-9]*
Kind	Value				
pattern	[1-9]{1}[0-9]*				

element **Riepilogo_Reddito_Type/AltriRedditi**

diagram					
namespace	urn:www.agenziaentrate.gov.it:specificheTecniche:sco:730				
type	DatoNP_Type				
facets	<table border="1"> <tr> <td>Kind</td> <td>Value</td> </tr> <tr> <td>pattern</td> <td>[1-9]{1}[0-9]*</td> </tr> </table>	Kind	Value	pattern	[1-9]{1}[0-9]*
Kind	Value				
pattern	[1-9]{1}[0-9]*				

element Riepilogo_Reddi_Type/ImponibileCedolare

diagram	
namespace	urn:www.agenziaentrate.gov.it:specificheTecniche:sco:730
type	DatoNP_Type
facets	Kind Value pattern [1-9]{1}[0-9]*

element Riepilogo_Reddi_Type/ImponibileCedolareOrdinario

diagram	
namespace	urn:www.agenziaentrate.gov.it:specificheTecniche:sco:730
type	DatoNP_Type
facets	Kind Value pattern [1-9]{1}[0-9]*

element Riepilogo_Reddi_Type/ImponibileCedolareAgevolato

diagram	
namespace	urn:www.agenziaentrate.gov.it:specificheTecniche:sco:730
type	DatoNP_Type
facets	Kind Value pattern [1-9]{1}[0-9]*

element Riepilogo_Reddi_Type/AbitazionePrincipalePertinenze

diagram	
namespace	urn:www.agenziaentrate.gov.it:specificheTecniche:sco:730
type	DatoNP_Type
facets	Kind Value pattern [1-9]{1}[0-9]*

complexType Ritenute_Acconti_Sospesi_Type

diagram	
namespace	urn:www.agenziaentrate.gov.it:specificheTecniche:sco:730
children	m730:CodiceEvento m730:lrpef m730:AddRegionalelrpef m730:AddComunalelrpef m730:CedolareSecca m730:ContribSolidarieta

element Ritenute_Acconti_Sospesi_Type/CodiceEvento

diagram															
namespace	urn:www.agenziaentrate.gov.it:specificheTecniche:sco:730														
type	m730:Codice_Evento_Eccezionale_Type														
facets	<table border="1"> <thead> <tr> <th>Kind</th> <th>Value</th> </tr> </thead> <tbody> <tr> <td>pattern</td> <td>[1-9]{1}[0-9]*</td> </tr> <tr> <td>enumeration</td> <td>1</td> </tr> <tr> <td>enumeration</td> <td>2</td> </tr> <tr> <td>enumeration</td> <td>3</td> </tr> <tr> <td>enumeration</td> <td>4</td> </tr> <tr> <td>enumeration</td> <td>30</td> </tr> </tbody> </table>	Kind	Value	pattern	[1-9]{1}[0-9]*	enumeration	1	enumeration	2	enumeration	3	enumeration	4	enumeration	30
Kind	Value														
pattern	[1-9]{1}[0-9]*														
enumeration	1														
enumeration	2														
enumeration	3														
enumeration	4														
enumeration	30														

element Ritenute_Acconti_Sospesi_Type/lrpef

diagram					
namespace	urn:www.agenziaentrate.gov.it:specificheTecniche:sco:730				
type	DatoNP_Type				
facets	<table border="1"> <thead> <tr> <th>Kind</th> <th>Value</th> </tr> </thead> <tbody> <tr> <td>pattern</td> <td>[1-9]{1}[0-9]*</td> </tr> </tbody> </table>	Kind	Value	pattern	[1-9]{1}[0-9]*
Kind	Value				
pattern	[1-9]{1}[0-9]*				

element Ritenute_Acconti_Sospesi_Type/AddRegionalelrpef

diagram	
namespace	urn:www.agenziaentrate.gov.it:specificheTecniche:sco:730
type	DatoNP_Type

facets	Kind pattern	Value [1-9]{1}[0-9]*
--------	-----------------	-------------------------

element **Ritenute_Acconti_Sospesi_Type/AddComunalelrpef**

diagram		
namespace	urn:www.agenziaentrate.gov.it:specificheTecniche:sco:730	
type	DatoNP_Type	
facets	Kind pattern	Value [1-9]{1}[0-9]*

element **Ritenute_Acconti_Sospesi_Type/CedolareSecca**

diagram		
namespace	urn:www.agenziaentrate.gov.it:specificheTecniche:sco:730	
type	DatoNP_Type	
facets	Kind pattern	Value [1-9]{1}[0-9]*

element **Ritenute_Acconti_Sospesi_Type/ContribSolidarieta**

diagram		
namespace	urn:www.agenziaentrate.gov.it:specificheTecniche:sco:730	
type	DatoNP_Type	
facets	Kind pattern	Value [1-9]{1}[0-9]*

complexType **Ritenute_Lavoro_Dip_Type**

diagram		
namespace	urn:www.agenziaentrate.gov.it:specificheTecniche:sco:730	
children	m730:Ritlrpef m730:RitAddRegionale m730:RitAccAddComunale m730:RitSaldoAddComunale m730:RitAccAddComAnnoPres	

element Ritenute_Lavoro_Dip_Type/Ritlrpef

diagram	
namespace	urn:www.agenziaentrate.gov.it:specificheTecniche:sco:730
type	DatoNP_Type
facets	Kind Value pattern [1-9]{1}[0-9]*

element Ritenute_Lavoro_Dip_Type/RitAddRegionale

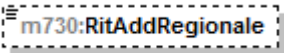
diagram	
namespace	urn:www.agenziaentrate.gov.it:specificheTecniche:sco:730
type	DatoNP_Type
facets	Kind Value pattern [1-9]{1}[0-9]*

element Ritenute_Lavoro_Dip_Type/RitAccAddComunale

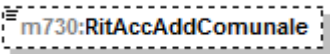
diagram	
namespace	urn:www.agenziaentrate.gov.it:specificheTecniche:sco:730
type	DatoNP_Type
facets	Kind Value pattern [1-9]{1}[0-9]*

element Ritenute_Lavoro_Dip_Type/RitSaldoAddComunale

diagram	
namespace	urn:www.agenziaentrate.gov.it:specificheTecniche:sco:730
type	DatoNP_Type
facets	Kind Value pattern [1-9]{1}[0-9]*

element Ritenute_Lavoro_Dip_Type/RitAccAddComAnnoPres

diagram	
namespace	urn:www.agenziaentrate.gov.it:specificheTecniche:sco:730
type	DatoNP_Type
facets	Kind Value pattern [1-9]{1}[0-9]*

complexType **Sezione_Altri_Redd_Type**

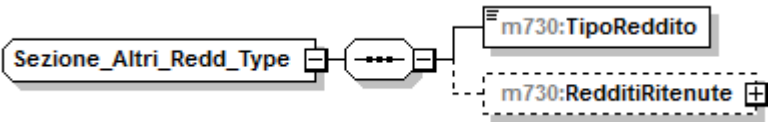
diagram	
namespace	urn:www.agenziaentrate.gov.it:specificheTecniche:sco:730
children	m730:TipoReddito m730:RedditiRitenute

element **Sezione_Altri_Redd_Type/TipoReddito**

diagram																					
namespace	urn:www.agenziaentrate.gov.it:specificheTecniche:sco:730																				
type	m730:Tipo_Reddito_Da1a8_Type																				
facets	<table border="1"> <thead> <tr> <th>Kind</th> <th>Value</th> </tr> </thead> <tbody> <tr> <td>pattern</td> <td>[1-9]{1}[0-9]*</td> </tr> <tr> <td>enumeration</td> <td>1</td> </tr> <tr> <td>enumeration</td> <td>2</td> </tr> <tr> <td>enumeration</td> <td>3</td> </tr> <tr> <td>enumeration</td> <td>4</td> </tr> <tr> <td>enumeration</td> <td>5</td> </tr> <tr> <td>enumeration</td> <td>6</td> </tr> <tr> <td>enumeration</td> <td>7</td> </tr> <tr> <td>enumeration</td> <td>8</td> </tr> </tbody> </table>	Kind	Value	pattern	[1-9]{1}[0-9]*	enumeration	1	enumeration	2	enumeration	3	enumeration	4	enumeration	5	enumeration	6	enumeration	7	enumeration	8
Kind	Value																				
pattern	[1-9]{1}[0-9]*																				
enumeration	1																				
enumeration	2																				
enumeration	3																				
enumeration	4																				
enumeration	5																				
enumeration	6																				
enumeration	7																				
enumeration	8																				

element **Sezione_Altri_Redd_Type/RedditiRitenute**

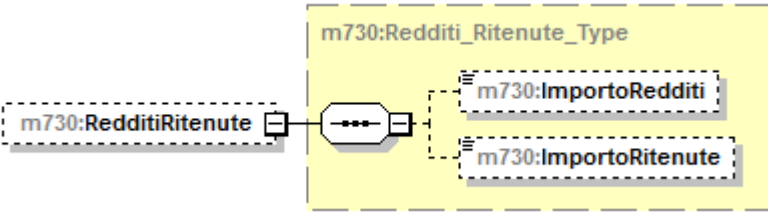
diagram	
namespace	urn:www.agenziaentrate.gov.it:specificheTecniche:sco:730
type	m730:Redditi_Ritenute_Type
children	m730:ImportoRedditi m730:ImportoRitenute

complexType **Sezione_Dati_Catastali_Recupero_Patrimonio_Edilizio_Type**

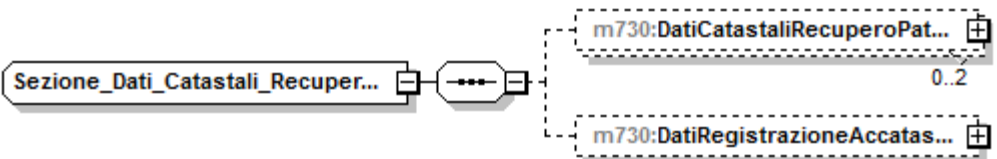
diagram	
---------	--

namespace	urn:www.agenziaentrate.gov.it:specificheTecniche:sco:730
children	m730:DatiCatastaliRecuperoPatrimonioEdilizio m730:DatiRegistrazioneAccatastamentoRecuperoPatrimonio_Edilizio

element

Sezione Dati_Catastali_Recupero_Patrimonio_Edilizio_Type/DatiCatastaliRecuperoPatrimonioEdilizio

diagram	
namespace	urn:www.agenziaentrate.gov.it:specificheTecniche:sco:730
type	extension of m730:Dati_Catastali_Recupero_Patrimonio_Edilizio_Type
children	m730:NOrdImmobile m730:Condominio m730:DatiCatastali

element

Sezione Dati_Catastali_Recupero_Patrimonio_Edilizio_Type/DatiRegistrazioneAccatastamentoRecuperoPatrimonio_Edilizio

diagram	
namespace	urn:www.agenziaentrate.gov.it:specificheTecniche:sco:730
type	m730:Dati_Registrazione_Accatastamento_Recupero_Patrimonio_Edilizio_Type
children	m730:NOrdImmobile m730:Condominio m730:EstremiRegistrazioneContratto m730:DomandaAccatastamento

namespace	urn:www.agenziaentrate.gov.it:specificheTecniche:sco:730				
type	DatoCF_Type				
facets	<table border="1"> <thead> <tr> <th>Kind</th> <th>Value</th> </tr> </thead> <tbody> <tr> <td>pattern</td> <td>[0-9]{11}[A-Z]{6}[0-9LMNPQRSTU]{2}[A-Z]{1}[0-9LMNPQRSTU]{2}[A-Z]{1}[0-9LMNPQRSTU]{3}[A-Z]{1}</td> </tr> </tbody> </table>	Kind	Value	pattern	[0-9]{11}[A-Z]{6}[0-9LMNPQRSTU]{2}[A-Z]{1}[0-9LMNPQRSTU]{2}[A-Z]{1}[0-9LMNPQRSTU]{3}[A-Z]{1}
Kind	Value				
pattern	[0-9]{11}[A-Z]{6}[0-9LMNPQRSTU]{2}[A-Z]{1}[0-9LMNPQRSTU]{2}[A-Z]{1}[0-9LMNPQRSTU]{3}[A-Z]{1}				

element **Soggetto_Assistenza_Fiscale_Doc_Type/DatiCafDoc**

diagram	
namespace	urn:www.agenziaentrate.gov.it:specificheTecniche:sco:730
type	extension of m730:Dati_CAF_Type
children	m730:CFCaf m730:DenominazioneCaf m730:NumeroAlbo m730:CFResponsabile m730:CognomeResponsabile m730:NomeResponsabile m730:CF Soc Servizi m730:Id Sede Periferica m730:Casella Attestazione Caf

element **Soggetto_Assistenza_Fiscale_Doc_Type/DatiCafDoc/CFResponsabile**

diagram					
namespace	urn:www.agenziaentrate.gov.it:specificheTecniche:sco:730				
type	DatoCF_Type				
facets	<table border="1"> <thead> <tr> <th>Kind</th> <th>Value</th> </tr> </thead> <tbody> <tr> <td>pattern</td> <td>[0-9]{11}[A-Z]{6}[0-9LMNPQRSTU]{2}[A-Z]{1}[0-9LMNPQRSTU]{2}[A-Z]{1}[0-9LMNPQRSTU]{3}[A-Z]{1}</td> </tr> </tbody> </table>	Kind	Value	pattern	[0-9]{11}[A-Z]{6}[0-9LMNPQRSTU]{2}[A-Z]{1}[0-9LMNPQRSTU]{2}[A-Z]{1}[0-9LMNPQRSTU]{3}[A-Z]{1}
Kind	Value				
pattern	[0-9]{11}[A-Z]{6}[0-9LMNPQRSTU]{2}[A-Z]{1}[0-9LMNPQRSTU]{2}[A-Z]{1}[0-9LMNPQRSTU]{3}[A-Z]{1}				

element **Soggetto_Assistenza_Fiscale_Doc_Type/DatiCafDoc/CognomeResponsabile**

diagram	
---------	--

namespace	urn:www.agenziaentrate.gov.it:specificheTecniche:sco:730
type	DatoAN_Type
facets	Kind Value pattern ([0-9A-Z\-\-]"){1}([0-9A-Z&:] ' \" \- \., / ° \"^\(\\ \\) À É È Ì Ò Ù Û " \\\" \\+)*

element **Soggetto_Assistenza_Fiscale_Doc_Type/DatiCafDoc/NomeResponsabile**

diagram	
namespace	urn:www.agenziaentrate.gov.it:specificheTecniche:sco:730
type	DatoAN_Type
facets	Kind Value pattern ([0-9A-Z\-\-]"){1}([0-9A-Z&:] ' \" \- \., / ° \"^\(\\ \\) À É È Ì Ò Ù Û " \\\" \\+)*

element **Soggetto_Assistenza_Fiscale_Doc_Type/DatiCafDoc/CFSocServizi**

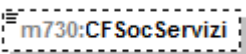
diagram	
namespace	urn:www.agenziaentrate.gov.it:specificheTecniche:sco:730
type	DatoCN_Type
facets	Kind Value pattern [0-9]{11}

element **Soggetto_Assistenza_Fiscale_Doc_Type/DatiCafDoc/IdSedePeriferica**

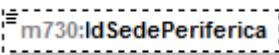
diagram	
namespace	urn:www.agenziaentrate.gov.it:specificheTecniche:sco:730
type	DatoAN_Type
facets	Kind Value pattern ([0-9A-Z\-\-]"){1}([0-9A-Z&:] ' \" \- \., / ° \"^\(\\ \\) À É È Ì Ò Ù Û " \\\" \\+)*

element **Soggetto_Assistenza_Fiscale_Doc_Type/DatiCafDoc/CasellaAttestazioneCaf**

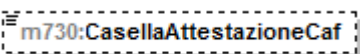
diagram	
namespace	urn:www.agenziaentrate.gov.it:specificheTecniche:sco:730
type	DatoCB_Type
facets	Kind Value pattern [01]

element **Soggetto_Assistenza_Fiscale_Doc_Type/DatiProfessionistaDoc**

diagram	<p>The diagram shows a class <code>m730:DatiProfessionistaDoc</code> on the left. A dashed box labeled <code>m730:Dati_Professionista_Type (extension)</code> contains three classes: <code>m730:CFProfessionista</code>, <code>m730:CognomeProfessionista</code>, and <code>m730:NomeProfessionista</code>. A solid line with an open arrowhead connects <code>m730:DatiProfessionistaDoc</code> to the extension box. A solid line with a filled arrowhead connects <code>m730:DatiProfessionistaDoc</code> to <code>m730:DatiNascitaProfessionista</code>, which has a plus sign in its bottom right corner.</p>
namespace	urn:www.agenziaentrate.gov.it:specificheTecniche:sco:730
type	extension of m730:Dati Professionista Type
children	m730:CFProfessionista m730:CognomeProfessionista m730:NomeProfessionista m730:DatiNascitaProfessionista

element **Soggetto_Assistenza_Fiscale_Doc_Type/DatiProfessionistaDoc/DatiNascitaProfessionista**

diagram	<p>The diagram shows a class <code>m730:DatiNascitaProfessionista</code> on the left. A dashed box labeled <code>m730:Dati_Nascita_PF_Type</code> contains four classes: <code>m730:Sesso</code>, <code>m730:DataNascita</code>, <code>m730:ComuneNascita</code>, and <code>m730:ProvinciaNascita</code>. A solid line with an open arrowhead connects <code>m730:DatiNascitaProfessionista</code> to the extension box. The <code>m730:ProvinciaNascita</code> class is enclosed in a dashed border.</p>
namespace	urn:www.agenziaentrate.gov.it:specificheTecniche:sco:730
type	m730:Dati_Nascita_PF_Type
children	m730:Sesso m730:DataNascita m730:ComuneNascita m730:ProvinciaNascita

element **Soggetto_Assistenza_Fiscale_Doc_Type/DatiAssociazioneDoc**

diagram	
namespace	urn:www.agenziaentrate.gov.it:specificheTecniche:sco:730
type	extension of m730:Dati_Associazioni_Professionale_Type
children	m730:CFAssociazione m730:DenominazioneAssociazione m730:CFProfessionista m730:CognomeProfessionista m730:NomeProfessionista m730:DatiNascitaProfessionista

element **Soggetto_Assistenza_Fiscale_Doc_Type/DatiAssociazioneDoc/DatiNascitaProfessionista**

diagram	
namespace	urn:www.agenziaentrate.gov.it:specificheTecniche:sco:730
type	m730:Dati_Nascita_PF_Type
children	m730:Sesso m730:DataNascita m730:ComuneNascita m730:ProvinciaNascita

element **Soggetto_Assistenza_Fiscale_Doc_Type/AgenziaEntrate**

diagram					
namespace	urn:www.agenziaentrate.gov.it:specificheTecniche:sco:730				
type	DatoCB_Type				
facets	<table border="1"> <tr> <td>Kind</td> <td>Value</td> </tr> <tr> <td>pattern</td> <td>[01]</td> </tr> </table>	Kind	Value	pattern	[01]
Kind	Value				
pattern	[01]				

complexType **Soggetto_Fiscale_730_Type**

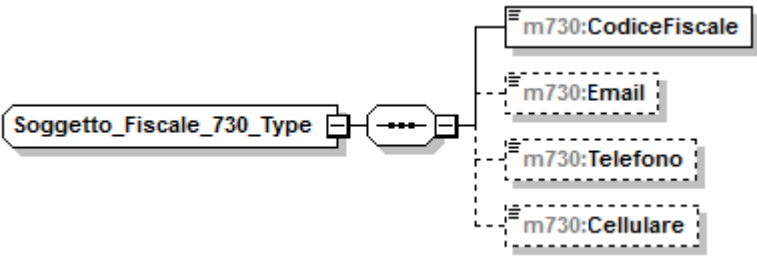
diagram	
namespace	urn:www.agenziaentrate.gov.it:specificheTecniche:sco:730
children	m730:CodiceFiscale m730:Email m730:Telefono m730:Cellulare

element **Soggetto_Fiscale_730_Type/CodiceFiscale**

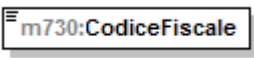
diagram					
namespace	urn:www.agenziaentrate.gov.it:specificheTecniche:sco:730				
type	DatoCF_Type				
facets	<table border="1"> <thead> <tr> <th>Kind</th> <th>Value</th> </tr> </thead> <tbody> <tr> <td>pattern</td> <td>[0-9]{11}[A-Z]{6}[0-9LMNPQRSTU]{2}[A-Z]{1}[0-9LMNPQRSTU]{2}[A-Z]{1}[0-9LMNPQRSTU]{3}[A-Z]{1}</td> </tr> </tbody> </table>	Kind	Value	pattern	[0-9]{11}[A-Z]{6}[0-9LMNPQRSTU]{2}[A-Z]{1}[0-9LMNPQRSTU]{2}[A-Z]{1}[0-9LMNPQRSTU]{3}[A-Z]{1}
Kind	Value				
pattern	[0-9]{11}[A-Z]{6}[0-9LMNPQRSTU]{2}[A-Z]{1}[0-9LMNPQRSTU]{2}[A-Z]{1}[0-9LMNPQRSTU]{3}[A-Z]{1}				

element **Soggetto_Fiscale_730_Type/Email**

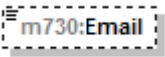
diagram					
namespace	urn:www.agenziaentrate.gov.it:specificheTecniche:sco:730				
type	DatoEM_Type				
facets	<table border="1"> <thead> <tr> <th>Kind</th> <th>Value</th> </tr> </thead> <tbody> <tr> <td>pattern</td> <td>[a-zA-Z0-9._%'\-&quot;?^~=]+@[a-zA-Z0-9.\-]+\.[a-zA-Z]{2,4}</td> </tr> </tbody> </table>	Kind	Value	pattern	[a-zA-Z0-9._%'\-"?^~=]+@[a-zA-Z0-9.\-]+\.[a-zA-Z]{2,4}
Kind	Value				
pattern	[a-zA-Z0-9._%'\-"?^~=]+@[a-zA-Z0-9.\-]+\.[a-zA-Z]{2,4}				

element **Soggetto_Fiscale_730_Type/Telefono**

diagram					
namespace	urn:www.agenziaentrate.gov.it:specificheTecniche:sco:730				
type	DatoAN_Type				
facets	<table border="1"> <thead> <tr> <th>Kind</th> <th>Value</th> </tr> </thead> <tbody> <tr> <td>pattern</td> <td>([0-9A-Z\-\&quot;]{1}([0-9A-Z&amp;] '\-\. / °\^\(\)\ À É È Ì Ò Ù Û &quot; \N\ +)*</td> </tr> </tbody> </table>	Kind	Value	pattern	([0-9A-Z\-\"]{1}([0-9A-Z&] '\-\. / °\^\(\)\ À É È Ì Ò Ù Û " \N\ +)*
Kind	Value				
pattern	([0-9A-Z\-\"]{1}([0-9A-Z&] '\-\. / °\^\(\)\ À É È Ì Ò Ù Û " \N\ +)*				

element **Soggetto_Fiscale_730_Type/Cellulare**

diagram					
namespace	urn:www.agenziaentrate.gov.it:specificheTecniche:sco:730				
type	DatoAN_Type				
facets	<table border="0"> <tr> <td>Kind</td> <td>Value</td> </tr> <tr> <td>pattern</td> <td>(([0-9A-Z-] \&quot;){1}([0-9A-Z&amp;:] \" \- \., / ° ^\ \\(\) À É È Ì Ò Ù Ü &quot; \\ / +)*</td> </tr> </table>	Kind	Value	pattern	(([0-9A-Z-] \"){1}([0-9A-Z&:] \" \- \., / ° ^\ \\(\) À É È Ì Ò Ù Ü " \\ / +)*
Kind	Value				
pattern	(([0-9A-Z-] \"){1}([0-9A-Z&:] \" \- \., / ° ^\ \\(\) À É È Ì Ò Ù Ü " \\ / +)*				

complexType **Soglie_Esenzione_Type**

diagram	
namespace	urn:www.agenziaentrate.gov.it:specificheTecniche:sco:730
children	m730:SogliaEsenzione m730:EsenzioneTotale

element **Soglie_Esenzione_Type/SogliaEsenzione**

diagram					
namespace	urn:www.agenziaentrate.gov.it:specificheTecniche:sco:730				
type	DatoNP_Type				
facets	<table border="0"> <tr> <td>Kind</td> <td>Value</td> </tr> <tr> <td>pattern</td> <td>[1-9]{1}[0-9]*</td> </tr> </table>	Kind	Value	pattern	[1-9]{1}[0-9]*
Kind	Value				
pattern	[1-9]{1}[0-9]*				

element **Soglie_Esenzione_Type/EsenzioneTotale**

diagram									
namespace	urn:www.agenziaentrate.gov.it:specificheTecniche:sco:730								
type	restriction of DatoN1_Type								
facets	<table border="0"> <tr> <td>Kind</td> <td>Value</td> </tr> <tr> <td>pattern</td> <td>[1-9]</td> </tr> <tr> <td>enumeration</td> <td>1</td> </tr> <tr> <td>enumeration</td> <td>2</td> </tr> </table>	Kind	Value	pattern	[1-9]	enumeration	1	enumeration	2
Kind	Value								
pattern	[1-9]								
enumeration	1								
enumeration	2								

complexType **Sostituto_Type**

diagram	
namespace	urn:www.agenziaentrate.gov.it:specificheTecniche:sco:730
children	m730:CodiceFiscale m730:DatiAnagraficiPF m730:DenominazionePNF m730:Residenza m730:Fax m730:CodiceSede

element **Sostituto_Type/CodiceFiscale**

diagram					
namespace	urn:www.agenziaentrate.gov.it:specificheTecniche:sco:730				
type	DatoCF_Type				
facets	<table border="1"> <thead> <tr> <th>Kind</th> <th>Value</th> </tr> </thead> <tbody> <tr> <td>pattern</td> <td>[0-9]{11}[A-Z]{6}[0-9LMNPQRSTUUV]{2}[A-Z]{1}[0-9LMNPQRSTUUV]{2}[A-Z]{1}[0-9LMNPQRSTUUV]{3}[A-Z]{1}</td> </tr> </tbody> </table>	Kind	Value	pattern	[0-9]{11}[A-Z]{6}[0-9LMNPQRSTUUV]{2}[A-Z]{1}[0-9LMNPQRSTUUV]{2}[A-Z]{1}[0-9LMNPQRSTUUV]{3}[A-Z]{1}
Kind	Value				
pattern	[0-9]{11}[A-Z]{6}[0-9LMNPQRSTUUV]{2}[A-Z]{1}[0-9LMNPQRSTUUV]{2}[A-Z]{1}[0-9LMNPQRSTUUV]{3}[A-Z]{1}				

element **Sostituto_Type/DatiAnagraficiPF**

diagram	
namespace	urn:www.agenziaentrate.gov.it:specificheTecniche:sco:730
children	m730:Cognome m730:Nome

element **Sostituto_Type/DatiAnagraficiPF/Cognome**

diagram					
namespace	urn:www.agenziaentrate.gov.it:specificheTecniche:sco:730				
type	DatoAN_Type				
facets	<table border="1"> <thead> <tr> <th>Kind</th> <th>Value</th> </tr> </thead> <tbody> <tr> <td>pattern</td> <td>([0-9A-Z-] \&quot;){1}([0-9A-Z&amp;:] [-\., / °\^\(\)\ À É È Ì Ò Ù Û &quot; \ \ \+)*</td> </tr> </tbody> </table>	Kind	Value	pattern	([0-9A-Z-] \"){1}([0-9A-Z&:] [-\., / °\^\(\)\ À É È Ì Ò Ù Û " \ \ \+)*
Kind	Value				
pattern	([0-9A-Z-] \"){1}([0-9A-Z&:] [-\., / °\^\(\)\ À É È Ì Ò Ù Û " \ \ \+)*				

element **Sostituto_Type/DatiAnagraficiPF/Nome**

diagram	
namespace	urn:www.agenziaentrate.gov.it:specificheTecniche:sco:730
type	DatoAN_Type
facets	Kind Value pattern ([0-9A-Z-] \"){1}([0-9A-Z&] '\- \., / \^\(\ \)\ À É È Ì Ò Ù Ü " \ \\ \ +)*

element **Sostituto_Type/DenominazionePNF**

diagram	
namespace	urn:www.agenziaentrate.gov.it:specificheTecniche:sco:730
type	DatoAN_Type
facets	Kind Value pattern ([0-9A-Z-] \"){1}([0-9A-Z&] '\- \., / \^\(\ \)\ À É È Ì Ò Ù Ü " \ \\ \ +)*

element **Sostituto_Type/Residenza**

diagram	
namespace	urn:www.agenziaentrate.gov.it:specificheTecniche:sco:730
type	m730:Residenza_Type
children	m730:Comune m730:Provincia m730:CodiceComune m730:Cap m730:Tipologia m730:Indirizzo m730:NumCivico m730:Frazione m730:Email m730:Telefono

element **Sostituto_Type/Fax**

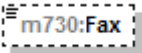
diagram	
namespace	urn:www.agenziaentrate.gov.it:specificheTecniche:sco:730
type	DatoAN_Type
facets	Kind Value pattern ([0-9A-Z\-\-]*)"}{1}([0-9A-Z&:] ' - \., / ^*\^*\(\ \)\ À É È Ì Ò Ù Û " \ \\ \ +)*

element **Sostituto_Type/CodiceSede**

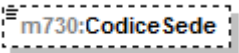
diagram	
namespace	urn:www.agenziaentrate.gov.it:specificheTecniche:sco:730
type	DatoAN_Type
facets	Kind Value pattern ([0-9A-Z\-\-]*)"}{1}([0-9A-Z&:] ' - \., / ^*\^*\(\ \)\ À É È Ì Ò Ù Û " \ \\ \ +)*

complexType **Spese_Arredo_Type**

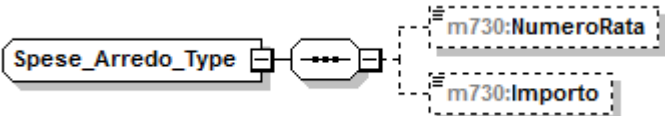
diagram	
namespace	urn:www.agenziaentrate.gov.it:specificheTecniche:sco:730
children	m730:NumeroRata m730:Importo

element **Spese_Arredo_Type/NumeroRata**

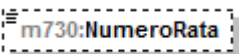
diagram	
namespace	urn:www.agenziaentrate.gov.it:specificheTecniche:sco:730
type	m730:Numero_RateDa1A3_Type
facets	Kind Value pattern [1-9] enumeration 1 enumeration 2 enumeration 3

element **Spese_Arredo_Type/Importo**

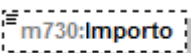
diagram	
namespace	urn:www.agenziaentrate.gov.it:specificheTecniche:sco:730

type	DatoNP_Type
facets	Kind Value pattern [1-9]{1}[0-9]*

complexType [Spese_Rateizzate_Anni_Precedenti_Type](#)

diagram	
namespace	urn:www.agenziaentrate.gov.it:specificheTecniche:sco:730
children	m730:Codice m730:Importo

element [Spese_Rateizzate_Anni_Precedenti_Type/Codice](#)

diagram	
namespace	urn:www.agenziaentrate.gov.it:specificheTecniche:sco:730
type	m730:Codice Spese_Rateizzate_Anni_Precedenti_Type
facets	Kind Value pattern [1-9]{1}[0-9]* enumeration 2 enumeration 3 enumeration 4

element [Spese_Rateizzate_Anni_Precedenti_Type/Importo](#)

diagram	
namespace	urn:www.agenziaentrate.gov.it:specificheTecniche:sco:730
type	DatoNP_Type
facets	Kind Value pattern [1-9]{1}[0-9]*

complexType [Spese_Rateizzate_Type](#)

diagram	
namespace	urn:www.agenziaentrate.gov.it:specificheTecniche:sco:730
children	m730:Codice m730:Importo

element **Spese_Rateizzate_Type/Codice**

diagram													
namespace	urn:www.agenziaentrate.gov.it:specificheTecniche:sco:730												
type	m730:Codice Spese_Rateizzate_Type												
facets	<table border="1"> <thead> <tr> <th>Kind</th> <th>Value</th> </tr> </thead> <tbody> <tr> <td>pattern</td> <td>[1-9]{1}[0-9]*</td> </tr> <tr> <td>enumeration</td> <td>1</td> </tr> <tr> <td>enumeration</td> <td>2</td> </tr> <tr> <td>enumeration</td> <td>3</td> </tr> <tr> <td>enumeration</td> <td>4</td> </tr> </tbody> </table>	Kind	Value	pattern	[1-9]{1}[0-9]*	enumeration	1	enumeration	2	enumeration	3	enumeration	4
Kind	Value												
pattern	[1-9]{1}[0-9]*												
enumeration	1												
enumeration	2												
enumeration	3												
enumeration	4												

element **Spese_Rateizzate_Type/Importo**

diagram					
namespace	urn:www.agenziaentrate.gov.it:specificheTecniche:sco:730				
type	DatoNP_Type				
facets	<table border="1"> <thead> <tr> <th>Kind</th> <th>Value</th> </tr> </thead> <tbody> <tr> <td>pattern</td> <td>[1-9]{1}[0-9]*</td> </tr> </tbody> </table>	Kind	Value	pattern	[1-9]{1}[0-9]*
Kind	Value				
pattern	[1-9]{1}[0-9]*				

complexType **Tassazione_Separata_Type**

diagram	
namespace	urn:www.agenziaentrate.gov.it:specificheTecniche:sco:730
children	m730:Opzione m730:Anno m730:RedditoRitenute

element **Tassazione_Separata_Type/Opzione**

diagram					
namespace	urn:www.agenziaentrate.gov.it:specificheTecniche:sco:730				
type	DatoCB_Type				
facets	<table border="1"> <thead> <tr> <th>Kind</th> <th>Value</th> </tr> </thead> <tbody> <tr> <td>pattern</td> <td>[01]</td> </tr> </tbody> </table>	Kind	Value	pattern	[01]
Kind	Value				
pattern	[01]				

element **Tassazione_Separata_Type/Anno**

diagram	
---------	--

namespace	urn:www.agenziaentrate.gov.it:specificheTecniche:sco:730
type	DatoDA Type
facets	Kind Value pattern (18 19 20)[0-9]{2}

element Tassazione_Separata_Type/RedditoRitenute

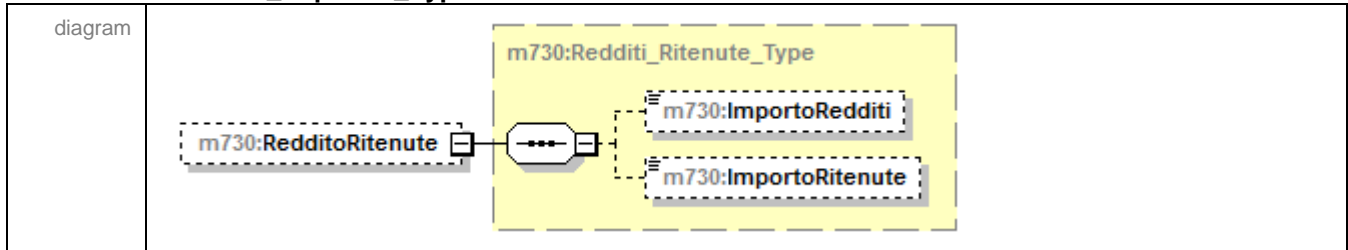

namespace	urn:www.agenziaentrate.gov.it:specificheTecniche:sco:730
type	m730:Redditi Ritenute Type
children	m730:ImportoRedditi m730:ImportoRitenute

complexType Terreno_Type

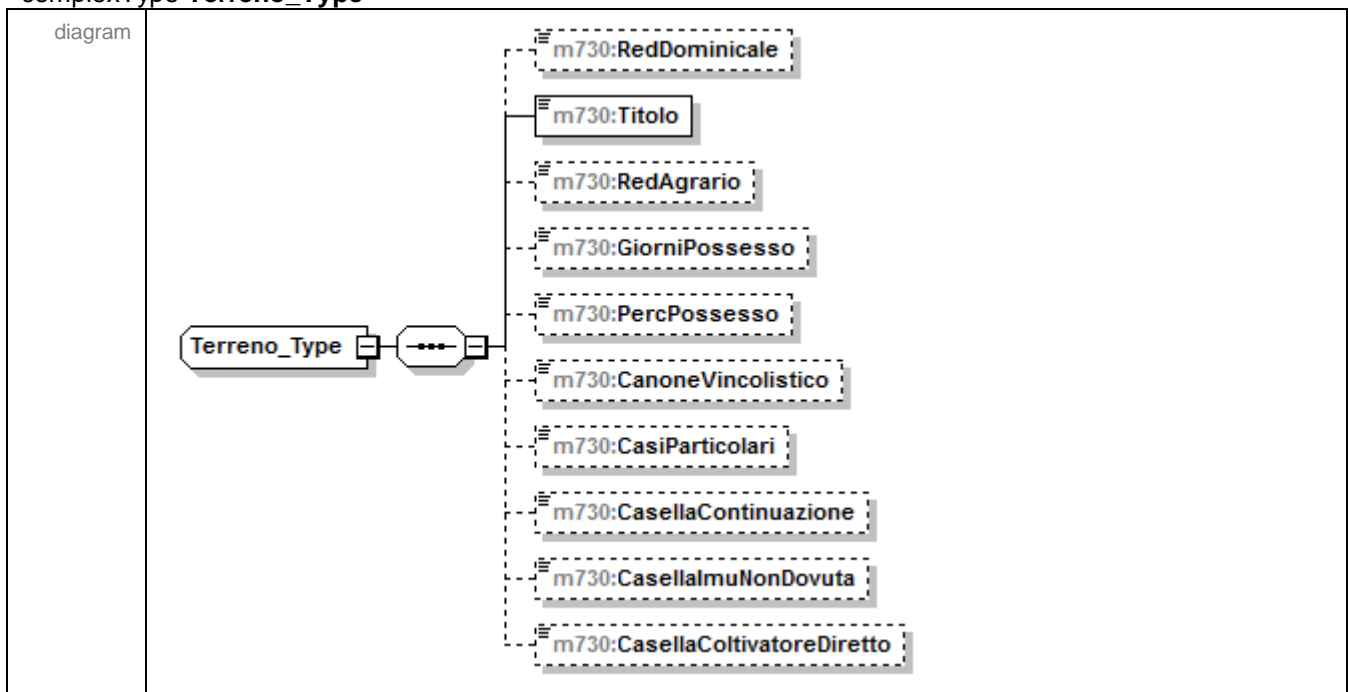

namespace	urn:www.agenziaentrate.gov.it:specificheTecniche:sco:730
children	m730:RedDominicale m730:Titolo m730:RedAgrario m730:GiorniPossesso m730:PercPossesso m730:CanoneVincolistico m730:CasiParticolari m730:CasellaContinuazione m730:CasellalmuNonDovuta m730:CasellaColtivatoreDiretto

element **Terreno_Type/RedDominicale**

diagram					
namespace	urn:www.agenziaentrate.gov.it:specificheTecniche:sco:730				
type	DatoNP_Type				
facets	<table border="1"> <thead> <tr> <th>Kind</th> <th>Value</th> </tr> </thead> <tbody> <tr> <td>pattern</td> <td>[1-9]{1}[0-9]*</td> </tr> </tbody> </table>	Kind	Value	pattern	[1-9]{1}[0-9]*
Kind	Value				
pattern	[1-9]{1}[0-9]*				

element **Terreno_Type/Titolo**

diagram																					
namespace	urn:www.agenziaentrate.gov.it:specificheTecniche:sco:730																				
type	m730:Titolo_Terreno_Type																				
facets	<table border="1"> <thead> <tr> <th>Kind</th> <th>Value</th> </tr> </thead> <tbody> <tr> <td>pattern</td> <td>[1-9]{1}[0-9]*</td> </tr> <tr> <td>enumeration</td> <td>1</td> </tr> <tr> <td>enumeration</td> <td>2</td> </tr> <tr> <td>enumeration</td> <td>3</td> </tr> <tr> <td>enumeration</td> <td>4</td> </tr> <tr> <td>enumeration</td> <td>5</td> </tr> <tr> <td>enumeration</td> <td>6</td> </tr> <tr> <td>enumeration</td> <td>7</td> </tr> <tr> <td>enumeration</td> <td>10</td> </tr> </tbody> </table>	Kind	Value	pattern	[1-9]{1}[0-9]*	enumeration	1	enumeration	2	enumeration	3	enumeration	4	enumeration	5	enumeration	6	enumeration	7	enumeration	10
Kind	Value																				
pattern	[1-9]{1}[0-9]*																				
enumeration	1																				
enumeration	2																				
enumeration	3																				
enumeration	4																				
enumeration	5																				
enumeration	6																				
enumeration	7																				
enumeration	10																				

element **Terreno_Type/RedAgrario**

diagram					
namespace	urn:www.agenziaentrate.gov.it:specificheTecniche:sco:730				
type	DatoNP_Type				
facets	<table border="1"> <thead> <tr> <th>Kind</th> <th>Value</th> </tr> </thead> <tbody> <tr> <td>pattern</td> <td>[1-9]{1}[0-9]*</td> </tr> </tbody> </table>	Kind	Value	pattern	[1-9]{1}[0-9]*
Kind	Value				
pattern	[1-9]{1}[0-9]*				

element **Terreno_Type/GiorniPossesso**

diagram					
namespace	urn:www.agenziaentrate.gov.it:specificheTecniche:sco:730				
type	DatoGA_Type				
facets	<table border="1"> <thead> <tr> <th>Kind</th> <th>Value</th> </tr> </thead> <tbody> <tr> <td>pattern</td> <td>[1-9]{1}([1-9][0-9])?((12)[0-9][0-9])?(3[0-5][0-9])?(36[0-5])?</td> </tr> </tbody> </table>	Kind	Value	pattern	[1-9]{1}([1-9][0-9])?((12)[0-9][0-9])?(3[0-5][0-9])?(36[0-5])?
Kind	Value				
pattern	[1-9]{1}([1-9][0-9])?((12)[0-9][0-9])?(3[0-5][0-9])?(36[0-5])?				

element **Terreno_Type/PercPossesso**

diagram	
---------	--

namespace	urn:www.agenziaentrate.gov.it:specificheTecniche:sco:730				
type	DatoPC_Type				
facets	<table border="1"> <tr> <td>Kind</td> <td>Value</td> </tr> <tr> <td>pattern</td> <td>[0-9]?[0-9](,\d{1,3})? 100,0{1,3}?</td> </tr> </table>	Kind	Value	pattern	[0-9]?[0-9](,\d{1,3})? 100,0{1,3}?
Kind	Value				
pattern	[0-9]?[0-9](,\d{1,3})? 100,0{1,3}?				

element **Terreno_Type/CanoneVincolistico**

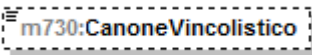
diagram					
namespace	urn:www.agenziaentrate.gov.it:specificheTecniche:sco:730				
type	DatoNP_Type				
facets	<table border="1"> <tr> <td>Kind</td> <td>Value</td> </tr> <tr> <td>pattern</td> <td>[1-9]{1}[0-9]*</td> </tr> </table>	Kind	Value	pattern	[1-9]{1}[0-9]*
Kind	Value				
pattern	[1-9]{1}[0-9]*				

element **Terreno_Type/CasiParticolari**

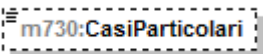
diagram													
namespace	urn:www.agenziaentrate.gov.it:specificheTecniche:sco:730												
type	m730:Casi_Particolari_Terreni_Type												
facets	<table border="1"> <tr> <td>Kind</td> <td>Value</td> </tr> <tr> <td>pattern</td> <td>[1-9]</td> </tr> <tr> <td>enumeration</td> <td>2</td> </tr> <tr> <td>enumeration</td> <td>3</td> </tr> <tr> <td>enumeration</td> <td>4</td> </tr> <tr> <td>enumeration</td> <td>6</td> </tr> </table>	Kind	Value	pattern	[1-9]	enumeration	2	enumeration	3	enumeration	4	enumeration	6
Kind	Value												
pattern	[1-9]												
enumeration	2												
enumeration	3												
enumeration	4												
enumeration	6												

element **Terreno_Type/CasellaContinuazione**

diagram					
namespace	urn:www.agenziaentrate.gov.it:specificheTecniche:sco:730				
type	DatoCB_Type				
facets	<table border="1"> <tr> <td>Kind</td> <td>Value</td> </tr> <tr> <td>pattern</td> <td>[01]</td> </tr> </table>	Kind	Value	pattern	[01]
Kind	Value				
pattern	[01]				

element **Terreno_Type/CasellalmuNonDovuta**

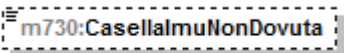
diagram					
namespace	urn:www.agenziaentrate.gov.it:specificheTecniche:sco:730				
type	DatoCB_Type				
facets	<table border="1"> <tr> <td>Kind</td> <td>Value</td> </tr> <tr> <td>pattern</td> <td>[01]</td> </tr> </table>	Kind	Value	pattern	[01]
Kind	Value				
pattern	[01]				

element **Terreno_Type/CasellaColtivatoreDiretto**

diagram	 m730:CasellaColtivatoreDiretto				
namespace	urn:www.agenziaentrate.gov.it:specificheTecniche:sco:730				
type	DatoCB_Type				
facets	<table border="1"> <thead> <tr> <th>Kind</th> <th>Value</th> </tr> </thead> <tbody> <tr> <td>pattern</td> <td>[01]</td> </tr> </tbody> </table>	Kind	Value	pattern	[01]
Kind	Value				
pattern	[01]				

complexType **Versamenti_F24_Type**

<p>diagram</p>	
<p>namespace</p>	<p>urn:www.agenziaentrate.gov.it:specificheTecniche:sco:730</p>
<p>children</p>	<p>m730:F24DebitoIrpef m730:F24DebitoCodRegione m730:F24DebitoAddReg m730:F24DebitoCodComune m730:F24DebitoAddCom m730:F24DebitoPrimaRataAcclrpef m730:F24DebitoAccontoTassSep m730:F24DebitoCodComuneAcconto m730:F24DebitoAccontoAddCom m730:F24DebitoCedolare m730:F24DebitoPrimaRataAccCedolare m730:F24DebitoContribSolidarieta m730:F24DebitoCodRegioneConiuge m730:F24DebitoAddRegConiuge m730:F24DebitoCodComuneConiuge m730:F24DebitoAddComConiuge m730:F24DebitoCodComuneAccConiuge m730:F24DebitoAccontoAddComConiuge m730:F24DebitoSecondaRataAccCedolare m730:F24DebitoSecondaRataAcclrpef m730:F24DebitoSecondaRataAccCedolare</p>

element **Versamenti_F24_Type/F24Debitolrpef**

diagram	 m730:F24Debitolrpef				
namespace	urn:www.agenziaentrate.gov.it:specificheTecniche:sco:730				
type	DatoNP_Type				
facets	<table border="1"> <thead> <tr> <th>Kind</th> <th>Value</th> </tr> </thead> <tbody> <tr> <td>pattern</td> <td>[1-9]{1}[0-9]*</td> </tr> </tbody> </table>	Kind	Value	pattern	[1-9]{1}[0-9]*
Kind	Value				
pattern	[1-9]{1}[0-9]*				

element **Versamenti_F24_Type/F24DebitoCodRegione**

diagram	 m730:F24DebitoCodRegione																																														
namespace	urn:www.agenziaentrate.gov.it:specificheTecniche:sco:730																																														
type	Codice_Regione_Type																																														
facets	<table border="1"> <thead> <tr> <th>Kind</th> <th>Value</th> </tr> </thead> <tbody> <tr> <td>pattern</td> <td>{([0-9A-Z&quot;]{1}([0-9A-Z&amp;] '\-\. , /°\^\(\ \)\À È É ì Ò Ù Ü &quot; \N \+)*</td> </tr> <tr><td>enumeration</td><td>1</td></tr> <tr><td>enumeration</td><td>2</td></tr> <tr><td>enumeration</td><td>3</td></tr> <tr><td>enumeration</td><td>4</td></tr> <tr><td>enumeration</td><td>5</td></tr> <tr><td>enumeration</td><td>6</td></tr> <tr><td>enumeration</td><td>7</td></tr> <tr><td>enumeration</td><td>8</td></tr> <tr><td>enumeration</td><td>9</td></tr> <tr><td>enumeration</td><td>10</td></tr> <tr><td>enumeration</td><td>11</td></tr> <tr><td>enumeration</td><td>12</td></tr> <tr><td>enumeration</td><td>13</td></tr> <tr><td>enumeration</td><td>14</td></tr> <tr><td>enumeration</td><td>15</td></tr> <tr><td>enumeration</td><td>16</td></tr> <tr><td>enumeration</td><td>17</td></tr> <tr><td>enumeration</td><td>18</td></tr> <tr><td>enumeration</td><td>19</td></tr> <tr><td>enumeration</td><td>20</td></tr> <tr><td>enumeration</td><td>21</td></tr> </tbody> </table>	Kind	Value	pattern	{([0-9A-Z"]{1}([0-9A-Z&] '\-\. , /°\^\(\ \)\À È É ì Ò Ù Ü " \N \+)*	enumeration	1	enumeration	2	enumeration	3	enumeration	4	enumeration	5	enumeration	6	enumeration	7	enumeration	8	enumeration	9	enumeration	10	enumeration	11	enumeration	12	enumeration	13	enumeration	14	enumeration	15	enumeration	16	enumeration	17	enumeration	18	enumeration	19	enumeration	20	enumeration	21
Kind	Value																																														
pattern	{([0-9A-Z"]{1}([0-9A-Z&] '\-\. , /°\^\(\ \)\À È É ì Ò Ù Ü " \N \+)*																																														
enumeration	1																																														
enumeration	2																																														
enumeration	3																																														
enumeration	4																																														
enumeration	5																																														
enumeration	6																																														
enumeration	7																																														
enumeration	8																																														
enumeration	9																																														
enumeration	10																																														
enumeration	11																																														
enumeration	12																																														
enumeration	13																																														
enumeration	14																																														
enumeration	15																																														
enumeration	16																																														
enumeration	17																																														
enumeration	18																																														
enumeration	19																																														
enumeration	20																																														
enumeration	21																																														

element **Versamenti_F24_Type/F24DebitoAddReg**

diagram	 m730:F24DebitoAddReg				
namespace	urn:www.agenziaentrate.gov.it:specificheTecniche:sco:730				
type	DatoNP_Type				
facets	<table border="1"> <thead> <tr> <th>Kind</th> <th>Value</th> </tr> </thead> <tbody> <tr> <td>pattern</td> <td>[1-9]{1}[0-9]*</td> </tr> </tbody> </table>	Kind	Value	pattern	[1-9]{1}[0-9]*
Kind	Value				
pattern	[1-9]{1}[0-9]*				

element **Versamenti_F24_Type/F24DebitoCodComune**

diagram	 m730:F24DebitoCodComune
namespace	urn:www.agenziaentrate.gov.it:specificheTecniche:sco:730
type	DatoAN_Type
facets	Kind Value pattern (([0-9A-Z-] \"){1}([0-9A-Z&] " - \., / "^\(\)\) À É È Ì Ò Ù Û " \N \\ +)*

element **Versamenti_F24_Type/F24DebitoAddCom**

diagram	 m730:F24DebitoAddCom
namespace	urn:www.agenziaentrate.gov.it:specificheTecniche:sco:730
type	DatoNP_Type
facets	Kind Value pattern [1-9]{1}[0-9]*

element **Versamenti_F24_Type/F24DebitoPrimaRataAcclrpef**

diagram	 m730:F24DebitoPrimaRataAcclrpef
namespace	urn:www.agenziaentrate.gov.it:specificheTecniche:sco:730
type	DatoNP_Type
facets	Kind Value pattern [1-9]{1}[0-9]*

element **Versamenti_F24_Type/F24DebitoAccontoTassSep**

diagram	 m730:F24DebitoAccontoTass Sep
namespace	urn:www.agenziaentrate.gov.it:specificheTecniche:sco:730
type	DatoNP_Type
facets	Kind Value pattern [1-9]{1}[0-9]*

element **Versamenti_F24_Type/F24DebitoCodComuneAcconto**

diagram	 m730:F24DebitoCodComuneAcc...
namespace	urn:www.agenziaentrate.gov.it:specificheTecniche:sco:730
type	DatoAN_Type
facets	Kind Value pattern (([0-9A-Z-] \"){1}([0-9A-Z&] " - \., / "^\(\)\) À É È Ì Ò Ù Û " \N \\ +)*

element **Versamenti_F24_Type/F24DebitoAccontoAddCom**

diagram	 m730:F24DebitoAccontoAddCom				
namespace	urn:www.agenziaentrate.gov.it:specificheTecniche:sco:730				
type	DatoNP_Type				
facets	<table border="1"> <tr> <td>Kind</td> <td>Value</td> </tr> <tr> <td>pattern</td> <td>[1-9]{1}[0-9]*</td> </tr> </table>	Kind	Value	pattern	[1-9]{1}[0-9]*
Kind	Value				
pattern	[1-9]{1}[0-9]*				

element **Versamenti_F24_Type/F24DebitoCedolare**

diagram	 m730:F24DebitoCedolare				
namespace	urn:www.agenziaentrate.gov.it:specificheTecniche:sco:730				
type	DatoNP_Type				
facets	<table border="1"> <tr> <td>Kind</td> <td>Value</td> </tr> <tr> <td>pattern</td> <td>[1-9]{1}[0-9]*</td> </tr> </table>	Kind	Value	pattern	[1-9]{1}[0-9]*
Kind	Value				
pattern	[1-9]{1}[0-9]*				

element **Versamenti_F24_Type/F24DebitoPrimaRataAccCedolare**

diagram	 m730:F24DebitoPrimaRataAccCe...				
namespace	urn:www.agenziaentrate.gov.it:specificheTecniche:sco:730				
type	DatoNP_Type				
facets	<table border="1"> <tr> <td>Kind</td> <td>Value</td> </tr> <tr> <td>pattern</td> <td>[1-9]{1}[0-9]*</td> </tr> </table>	Kind	Value	pattern	[1-9]{1}[0-9]*
Kind	Value				
pattern	[1-9]{1}[0-9]*				

element **Versamenti_F24_Type/F24DebitoContribSolidarieta**

diagram	 m730:F24DebitoContribSolidarieta				
namespace	urn:www.agenziaentrate.gov.it:specificheTecniche:sco:730				
type	DatoNP_Type				
facets	<table border="1"> <tr> <td>Kind</td> <td>Value</td> </tr> <tr> <td>pattern</td> <td>[1-9]{1}[0-9]*</td> </tr> </table>	Kind	Value	pattern	[1-9]{1}[0-9]*
Kind	Value				
pattern	[1-9]{1}[0-9]*				

element **Versamenti_F24_Type/F24DebitoCodRegioneConiuge**

diagram	 m730:F24DebitoCodRegioneConi...						
namespace	urn:www.agenziaentrate.gov.it:specificheTecniche:sco:730						
type	Codice_Regione_Type						
facets	<table border="1"> <tr> <td>Kind</td> <td>Value</td> </tr> <tr> <td>pattern</td> <td>(([0-9A-Z\-\-] &quot;){1}([0-9A-Z&amp;] '\ -\ \. , /° ^\ \\(\) À È É Ì Ò Ù Û &quot;; \\N \\+)*</td> </tr> <tr> <td>enumeration</td> <td>1</td> </tr> </table>	Kind	Value	pattern	(([0-9A-Z\-\-] "){1}([0-9A-Z&] '\ -\ \. , /° ^\ \\(\) À È É Ì Ò Ù Û "; \\N \\+)*	enumeration	1
Kind	Value						
pattern	(([0-9A-Z\-\-] "){1}([0-9A-Z&] '\ -\ \. , /° ^\ \\(\) À È É Ì Ò Ù Û "; \\N \\+)*						
enumeration	1						

enumeration	2
enumeration	3
enumeration	4
enumeration	5
enumeration	6
enumeration	7
enumeration	8
enumeration	9
enumeration	10
enumeration	11
enumeration	12
enumeration	13
enumeration	14
enumeration	15
enumeration	16
enumeration	17
enumeration	18
enumeration	19
enumeration	20
enumeration	21

element Versamenti_F24_Type/F24DebitoAddRegConiuge

diagram	 m730:F24DebitoAddRegConiuge				
namespace	urn:www.agenziaentrate.gov.it:specificheTecniche:sco:730				
type	DatoNP_Type				
facets	<table border="1"> <tr><td>Kind</td><td>Value</td></tr> <tr><td>pattern</td><td>[1-9]{1}[0-9]*</td></tr> </table>	Kind	Value	pattern	[1-9]{1}[0-9]*
Kind	Value				
pattern	[1-9]{1}[0-9]*				

element Versamenti_F24_Type/F24DebitoCodComuneConiuge

diagram	 m730:F24DebitoCodComuneCon...				
namespace	urn:www.agenziaentrate.gov.it:specificheTecniche:sco:730				
type	DatoAN_Type				
facets	<table border="1"> <tr><td>Kind</td><td>Value</td></tr> <tr><td>pattern</td><td>(([0-9A-Z\-\&quot;]{1}){([0-9A-Z&amp;:] \" \- \., / ° \"^\"(\)\ À É È Ì Ò Ù Ú &quot; \\ / +)*</td></tr> </table>	Kind	Value	pattern	(([0-9A-Z\-\"]{1}){([0-9A-Z&:] \" \- \., / ° \"^\"(\)\ À É È Ì Ò Ù Ú " \\ / +)*
Kind	Value				
pattern	(([0-9A-Z\-\"]{1}){([0-9A-Z&:] \" \- \., / ° \"^\"(\)\ À É È Ì Ò Ù Ú " \\ / +)*				

element Versamenti_F24_Type/F24DebitoAddComConiuge

diagram	 m730:F24DebitoAddComConiuge				
namespace	urn:www.agenziaentrate.gov.it:specificheTecniche:sco:730				
type	DatoNP_Type				
facets	<table border="1"> <tr><td>Kind</td><td>Value</td></tr> <tr><td>pattern</td><td>[1-9]{1}[0-9]*</td></tr> </table>	Kind	Value	pattern	[1-9]{1}[0-9]*
Kind	Value				
pattern	[1-9]{1}[0-9]*				

element **Versamenti_F24_Type/F24DebitoCodComuneAccontoConiuge**

diagram	
namespace	urn:www.agenziaentrate.gov.it:specificheTecniche:sco:730
type	DatoAN_Type
facets	Kind Value pattern ([0-9A-Z- "){1}([0-9A-Z&:] ' - \., / ° ^\ \\(\) À É Ê Ì Ò Ù Ü " \\ / +)*

element **Versamenti_F24_Type/F24DebitoAccontoAddComConiuge**

diagram	
namespace	urn:www.agenziaentrate.gov.it:specificheTecniche:sco:730
type	DatoNP_Type
facets	Kind Value pattern [1-9]{1}[0-9]*

element **Versamenti_F24_Type/F24DebitoSecondaRataAcclrpef**

diagram	
namespace	urn:www.agenziaentrate.gov.it:specificheTecniche:sco:730
type	DatoNP_Type
facets	Kind Value pattern [1-9]{1}[0-9]*

element **Versamenti_F24_Type/F24DebitoSecondaRataAccCedolare**

diagram	
namespace	urn:www.agenziaentrate.gov.it:specificheTecniche:sco:730
type	DatoNP_Type
facets	Kind Value pattern [1-9]{1}[0-9]*

element **Intestazione**

diagram	
namespace	urn:www.agenziaentrate.gov.it:specificheTecniche:sco:730

type	m730:Instestazione_730_Type
children	m730:TipoFornitore m730:SpazioUtente

complexType Instestazione_730_Type

diagram	
namespace	urn:www.agenziaentrate.gov.it:specificheTecniche:sco:730
children	m730:TipoFornitore m730:SpazioUtente

element Instestazione_730_Type/TipoFornitore

diagram																	
namespace	urn:www.agenziaentrate.gov.it:specificheTecniche:sco:730																
type	restriction of DatoAN_Type																
facets	<table border="1"> <thead> <tr> <th>Kind</th> <th>Value</th> </tr> </thead> <tbody> <tr> <td>pattern</td> <td>(([0-9A-Z\-\]]&quot;){1}([0-9A-Z&amp;]] ' \" . , / ° ^\(\\ \\) À È É Ì Ò Ù Ü &quot; \\ \\ \\ +)*</td> </tr> <tr> <td>enumeration</td> <td>1</td> </tr> <tr> <td>enumeration</td> <td>2</td> </tr> <tr> <td>enumeration</td> <td>3</td> </tr> <tr> <td>enumeration</td> <td>5</td> </tr> <tr> <td>enumeration</td> <td>6</td> </tr> <tr> <td>enumeration</td> <td>10</td> </tr> </tbody> </table>	Kind	Value	pattern	(([0-9A-Z\-\]]"){1}([0-9A-Z&]] ' \" . , / ° ^\(\\ \\) À È É Ì Ò Ù Ü " \\ \\ \\ +)*	enumeration	1	enumeration	2	enumeration	3	enumeration	5	enumeration	6	enumeration	10
Kind	Value																
pattern	(([0-9A-Z\-\]]"){1}([0-9A-Z&]] ' \" . , / ° ^\(\\ \\) À È É Ì Ò Ù Ü " \\ \\ \\ +)*																
enumeration	1																
enumeration	2																
enumeration	3																
enumeration	5																
enumeration	6																
enumeration	10																

element Instestazione_730_Type/SpazioUtente

diagram					
namespace	urn:www.agenziaentrate.gov.it:specificheTecniche:sco:730				
type	DatoAN_Type				
facets	<table border="1"> <thead> <tr> <th>Kind</th> <th>Value</th> </tr> </thead> <tbody> <tr> <td>pattern</td> <td>(([0-9A-Z\-\]]&quot;){1}([0-9A-Z&amp;]] ' \" . , / ° ^\(\\ \\ \\ \\) À È É Ì Ò Ù Ü &quot; \\ \\ \\ +)*</td> </tr> </tbody> </table>	Kind	Value	pattern	(([0-9A-Z\-\]]"){1}([0-9A-Z&]] ' \" . , / ° ^\(\\ \\ \\ \\) À È É Ì Ò Ù Ü " \\ \\ \\ +)*
Kind	Value				
pattern	(([0-9A-Z\-\]]"){1}([0-9A-Z&]] ' \" . , / ° ^\(\\ \\ \\ \\) À È É Ì Ò Ù Ü " \\ \\ \\ +)*				

element Fornitura

diagram	
namespace	www.agenziaentrate.gov.it:specificheTecniche:telent:v1

element Messaggio

diagram	
namespace	www.agenziaentrate.gov.it:specificheTecniche:telent:v1
children	tm:Intestazione tm:Contenuto

element Messaggio/Intestazione

diagram	
namespace	www.agenziaentrate.gov.it:specificheTecniche:telent:v1
type	tm:IntestazioneType
children	tm:CodiceFiscaleFornitore tm:SpazioServizioTelematico

element Messaggio/Contenuto

diagram											
namespace	www.agenziaentrate.gov.it:specificheTecniche:telent:v1										
type	tm:ContenutoType										
children	tm:Fornitura										
attributes	<table border="1"> <thead> <tr> <th>Name</th> <th>Type</th> <th>Use</th> <th>Default</th> <th>Fixed</th> </tr> </thead> <tbody> <tr> <td>CodiceFornitura</td> <td>derived by: xs:string</td> <td></td> <td></td> <td></td> </tr> </tbody> </table>	Name	Type	Use	Default	Fixed	CodiceFornitura	derived by: xs:string			
Name	Type	Use	Default	Fixed							
CodiceFornitura	derived by: xs:string										

complexType **ContenutoType**

diagram					
namespace	www.agenziaentrate.gov.it:specificheTecniche:telent:v1				
children	tm:Fornitura				
attributes	Name	Type	Use	Default	Fixed
	CodiceFornitura	derived by: xs:string			

attribute **ContenutoType/@CodiceFornitura**

type	restriction of xs:string				
facets	<table border="1"> <tr> <td>Kind</td> <td>Value</td> </tr> <tr> <td>pattern</td> <td>[A-Z0-9]{5}</td> </tr> </table>	Kind	Value	pattern	[A-Z0-9]{5}
Kind	Value				
pattern	[A-Z0-9]{5}				

complexType **IntestazioneType**

diagram					
namespace	www.agenziaentrate.gov.it:specificheTecniche:telent:v1				
children	tm:CodiceFiscaleFornitore tm:SpazioServizioTelematico				

element **IntestazioneType/CodiceFiscaleFornitore**

diagram					
namespace	www.agenziaentrate.gov.it:specificheTecniche:telent:v1				
type	restriction of xs:string				
facets	Kind	Value			
	pattern	[0-9]{11}[A-Z0-9]{16}			

element **IntestazioneType/SpazioServizioTelematico**

diagram					
namespace	www.agenziaentrate.gov.it:specificheTecniche:telent:v1				

type	restriction of xs:string
------	---------------------------------

simpleType Anno_Anticipazione_Fondo_Pensione_Type

namespace	urn:www.agenziaentrate.gov.it:specificheTecniche:sco:730																						
type	restriction of DatoNP_Type																						
facets	<table border="1"> <thead> <tr> <th>Kind</th> <th>Value</th> </tr> </thead> <tbody> <tr> <td>pattern</td> <td>[1-9]{1}[0-9]*</td> </tr> <tr> <td>enumeration</td> <td>2007</td> </tr> <tr> <td>enumeration</td> <td>2008</td> </tr> <tr> <td>enumeration</td> <td>2009</td> </tr> <tr> <td>enumeration</td> <td>2010</td> </tr> <tr> <td>enumeration</td> <td>2011</td> </tr> <tr> <td>enumeration</td> <td>2012</td> </tr> <tr> <td>enumeration</td> <td>2013</td> </tr> <tr> <td>enumeration</td> <td>2014</td> </tr> <tr> <td>enumeration</td> <td>2015</td> </tr> </tbody> </table>	Kind	Value	pattern	[1-9]{1}[0-9]*	enumeration	2007	enumeration	2008	enumeration	2009	enumeration	2010	enumeration	2011	enumeration	2012	enumeration	2013	enumeration	2014	enumeration	2015
Kind	Value																						
pattern	[1-9]{1}[0-9]*																						
enumeration	2007																						
enumeration	2008																						
enumeration	2009																						
enumeration	2010																						
enumeration	2011																						
enumeration	2012																						
enumeration	2013																						
enumeration	2014																						
enumeration	2015																						

simpleType Anno_Patrimonio_Edilizio_Situazioni_Particolari_Type

namespace	urn:www.agenziaentrate.gov.it:specificheTecniche:sco:730						
type	restriction of DatoNP_Type						
facets	<table border="1"> <thead> <tr> <th>Kind</th> <th>Value</th> </tr> </thead> <tbody> <tr> <td>pattern</td> <td>[1-9]{1}[0-9]*</td> </tr> <tr> <td>enumeration</td> <td>2011</td> </tr> </tbody> </table>	Kind	Value	pattern	[1-9]{1}[0-9]*	enumeration	2011
Kind	Value						
pattern	[1-9]{1}[0-9]*						
enumeration	2011						

simpleType Anno_Ricupero_Patrimonio_Edilizio_Type

namespace	urn:www.agenziaentrate.gov.it:specificheTecniche:sco:730																								
type	restriction of DatoNP_Type																								
facets	<table border="1"> <thead> <tr> <th>Kind</th> <th>Value</th> </tr> </thead> <tbody> <tr> <td>pattern</td> <td>[1-9]{1}[0-9]*</td> </tr> <tr> <td>enumeration</td> <td>2006</td> </tr> <tr> <td>enumeration</td> <td>2007</td> </tr> <tr> <td>enumeration</td> <td>2008</td> </tr> <tr> <td>enumeration</td> <td>2009</td> </tr> <tr> <td>enumeration</td> <td>2010</td> </tr> <tr> <td>enumeration</td> <td>2011</td> </tr> <tr> <td>enumeration</td> <td>2012</td> </tr> <tr> <td>enumeration</td> <td>2013</td> </tr> <tr> <td>enumeration</td> <td>2014</td> </tr> <tr> <td>enumeration</td> <td>2015</td> </tr> </tbody> </table>	Kind	Value	pattern	[1-9]{1}[0-9]*	enumeration	2006	enumeration	2007	enumeration	2008	enumeration	2009	enumeration	2010	enumeration	2011	enumeration	2012	enumeration	2013	enumeration	2014	enumeration	2015
Kind	Value																								
pattern	[1-9]{1}[0-9]*																								
enumeration	2006																								
enumeration	2007																								
enumeration	2008																								
enumeration	2009																								
enumeration	2010																								
enumeration	2011																								
enumeration	2012																								
enumeration	2013																								
enumeration	2014																								
enumeration	2015																								

simpleType Anno_Risparmio_Energetico_Type

namespace	urn:www.agenziaentrate.gov.it:specificheTecniche:sco:730																
type	restriction of DatoNP_Type																
facets	<table border="1"> <thead> <tr> <th>Kind</th> <th>Value</th> </tr> </thead> <tbody> <tr> <td>pattern</td> <td>[1-9]{1}[0-9]*</td> </tr> <tr> <td>enumeration</td> <td>2008</td> </tr> <tr> <td>enumeration</td> <td>2010</td> </tr> <tr> <td>enumeration</td> <td>2011</td> </tr> <tr> <td>enumeration</td> <td>2012</td> </tr> <tr> <td>enumeration</td> <td>2013</td> </tr> <tr> <td>enumeration</td> <td>2014</td> </tr> </tbody> </table>	Kind	Value	pattern	[1-9]{1}[0-9]*	enumeration	2008	enumeration	2010	enumeration	2011	enumeration	2012	enumeration	2013	enumeration	2014
Kind	Value																
pattern	[1-9]{1}[0-9]*																
enumeration	2008																
enumeration	2010																
enumeration	2011																
enumeration	2012																
enumeration	2013																
enumeration	2014																

	enumeration	2015
--	-------------	------

simpleType **Casella_Codice_Type**

namespace	urn:www.agenziaentrate.gov.it:specificheTecniche:sco:730	
type	restriction of DatoN1_Type	
facets	Kind	Value
	pattern	[1-9]
	enumeration	1
	enumeration	4

simpleType **Casi_Particolari_Fabbricato_Type**

namespace	urn:www.agenziaentrate.gov.it:specificheTecniche:sco:730	
type	restriction of DatoN1_Type	
facets	Kind	Value
	pattern	[1-9]
	enumeration	1
	enumeration	3
	enumeration	4
	enumeration	5
	enumeration	6

simpleType **Casi_Particolari_Risp_Ener_Type**

namespace	urn:www.agenziaentrate.gov.it:specificheTecniche:sco:730	
type	restriction of DatoN1_Type	
facets	Kind	Value
	pattern	[1-9]
	enumeration	1
	enumeration	2
	enumeration	3

simpleType **Casi_Particolari_Terreni_Type**

namespace	urn:www.agenziaentrate.gov.it:specificheTecniche:sco:730	
type	restriction of DatoN1_Type	
facets	Kind	Value
	pattern	[1-9]
	enumeration	2
	enumeration	3
	enumeration	4
	enumeration	6

simpleType **Codice_Altre_Detrazioni_Type**

namespace	urn:www.agenziaentrate.gov.it:specificheTecniche:sco:730	
type	restriction of DatoNP_Type	
facets	Kind	Value
	pattern	[1-9]{1}[0-9]*
	enumeration	1
	enumeration	2

simpleType Codice_Altre_Spese_Type

namespace	urn:www.agenziaentrate.gov.it:specificheTecniche:sco:730	
type	restriction of DatoNP_Type	
facets	Kind	Value
	pattern	[1-9]{1}[0-9]*
	enumeration	8
	enumeration	9
	enumeration	10
	enumeration	11
	enumeration	12
	enumeration	13
	enumeration	14
	enumeration	15
	enumeration	16
	enumeration	17
	enumeration	18
	enumeration	20
	enumeration	21
	enumeration	22
	enumeration	23
	enumeration	24
	enumeration	25
	enumeration	26
	enumeration	27
	enumeration	28
	enumeration	29
	enumeration	30
	enumeration	31
	enumeration	32
	enumeration	33
	enumeration	35
	enumeration	36
	enumeration	37
	enumeration	41
	enumeration	42
	enumeration	99

simpleType Codice_Altri_Oneri_Type

namespace	urn:www.agenziaentrate.gov.it:specificheTecniche:sco:730	
type	restriction of DatoNP_Type	
facets	Kind	Value
	pattern	[1-9]{1}[0-9]*
	enumeration	6
	enumeration	7
	enumeration	8
	enumeration	9
	enumeration	11

simpleType Codice_Canone_Type

namespace	urn:www.agenziaentrate.gov.it:specificheTecniche:sco:730	
type	restriction of DatoN1_Type	
facets	Kind	Value
	pattern	[1-9]
	enumeration	1
	enumeration	2

	enumeration	3
	enumeration	4

simpleType **Codice_Evento_Eccezionale_Type**

namespace	urn:www.agenziaentrate.gov.it:specificheTecniche:sco:730	
type	restriction of DatoNP_Type	
facets	Kind	Value
	pattern	[1-9]{1}[0-9]*
	enumeration	1
	enumeration	2
	enumeration	3
	enumeration	4
	enumeration	30

simpleType **Codice_Spese_Rateizzate_Anni_Precedenti_Type**

namespace	urn:www.agenziaentrate.gov.it:specificheTecniche:sco:730	
type	restriction of DatoNP_Type	
facets	Kind	Value
	pattern	[1-9]{1}[0-9]*
	enumeration	2
	enumeration	3
	enumeration	4

simpleType **Codice_Spese_Rateizzate_Type**

namespace	urn:www.agenziaentrate.gov.it:specificheTecniche:sco:730	
type	restriction of DatoNP_Type	
facets	Kind	Value
	pattern	[1-9]{1}[0-9]*
	enumeration	1
	enumeration	2
	enumeration	3
	enumeration	4

simpleType **Fabbricato_Agev_Numero_Rigo_Type**

namespace	urn:www.agenziaentrate.gov.it:specificheTecniche:sco:730	
type	restriction of DatoNP_Type	
facets	Kind	Value
	pattern	[1-9]{1}[0-9]*
	enumeration	1
	enumeration	2
	enumeration	3
	enumeration	4
	enumeration	5
	enumeration	6
	enumeration	7
	enumeration	8
	enumeration	9
	enumeration	10

simpleType **Indeterminato_Determinato_Type**

namespace	urn:www.agenziaentrate.gov.it:specificheTecniche:sco:730								
type	restriction of DatoN1_Type								
facets	<table><thead><tr><th>Kind</th><th>Value</th></tr></thead><tbody><tr><td>pattern</td><td>[1-9]</td></tr><tr><td>enumeration</td><td>1</td></tr><tr><td>enumeration</td><td>2</td></tr></tbody></table>	Kind	Value	pattern	[1-9]	enumeration	1	enumeration	2
Kind	Value								
pattern	[1-9]								
enumeration	1								
enumeration	2								

simpleType **Integrativo_Type**

namespace	urn:www.agenziaentrate.gov.it:specificheTecniche:sco:730										
type	restriction of DatoN1_Type										
facets	<table><thead><tr><th>Kind</th><th>Value</th></tr></thead><tbody><tr><td>pattern</td><td>[1-9]</td></tr><tr><td>enumeration</td><td>1</td></tr><tr><td>enumeration</td><td>2</td></tr><tr><td>enumeration</td><td>3</td></tr></tbody></table>	Kind	Value	pattern	[1-9]	enumeration	1	enumeration	2	enumeration	3
Kind	Value										
pattern	[1-9]										
enumeration	1										
enumeration	2										
enumeration	3										

simpleType **Mesi_Type**

namespace	urn:www.agenziaentrate.gov.it:specificheTecniche:sco:730																												
type	restriction of DatoNP_Type																												
facets	<table><thead><tr><th>Kind</th><th>Value</th></tr></thead><tbody><tr><td>pattern</td><td>[1-9]{1}[0-9]*</td></tr><tr><td>enumeration</td><td>1</td></tr><tr><td>enumeration</td><td>2</td></tr><tr><td>enumeration</td><td>3</td></tr><tr><td>enumeration</td><td>4</td></tr><tr><td>enumeration</td><td>5</td></tr><tr><td>enumeration</td><td>6</td></tr><tr><td>enumeration</td><td>7</td></tr><tr><td>enumeration</td><td>8</td></tr><tr><td>enumeration</td><td>9</td></tr><tr><td>enumeration</td><td>10</td></tr><tr><td>enumeration</td><td>11</td></tr><tr><td>enumeration</td><td>12</td></tr></tbody></table>	Kind	Value	pattern	[1-9]{1}[0-9]*	enumeration	1	enumeration	2	enumeration	3	enumeration	4	enumeration	5	enumeration	6	enumeration	7	enumeration	8	enumeration	9	enumeration	10	enumeration	11	enumeration	12
Kind	Value																												
pattern	[1-9]{1}[0-9]*																												
enumeration	1																												
enumeration	2																												
enumeration	3																												
enumeration	4																												
enumeration	5																												
enumeration	6																												
enumeration	7																												
enumeration	8																												
enumeration	9																												
enumeration	10																												
enumeration	11																												
enumeration	12																												

simpleType **Numero_Rata_Risparmio_Energetico_Type**

namespace	urn:www.agenziaentrate.gov.it:specificheTecniche:sco:730																
type	restriction of DatoNP_Type																
facets	<table><thead><tr><th>Kind</th><th>Value</th></tr></thead><tbody><tr><td>pattern</td><td>[1-9]{1}[0-9]*</td></tr><tr><td>enumeration</td><td>1</td></tr><tr><td>enumeration</td><td>2</td></tr><tr><td>enumeration</td><td>3</td></tr><tr><td>enumeration</td><td>4</td></tr><tr><td>enumeration</td><td>5</td></tr><tr><td>enumeration</td><td>8</td></tr></tbody></table>	Kind	Value	pattern	[1-9]{1}[0-9]*	enumeration	1	enumeration	2	enumeration	3	enumeration	4	enumeration	5	enumeration	8
Kind	Value																
pattern	[1-9]{1}[0-9]*																
enumeration	1																
enumeration	2																
enumeration	3																
enumeration	4																
enumeration	5																
enumeration	8																

simpleType **Numero_Rate5o10_Type**

namespace	urn:www.agenziaentrate.gov.it:specificheTecniche:sco:730
type	restriction of DatoNP_Type

facets	Kind	Value
	pattern	[1-9]{1}[0-9]*
	enumeration	5
	enumeration	10

simpleType **Numero_RateDa1A3_Type**

namespace	urn:www.agenziaentrate.gov.it:specificheTecniche:sco:730	
type	restriction of DatoN1_Type	
facets	Kind	Value
	pattern	[1-9]
	enumeration	1
	enumeration	3

simpleType **Numero_RateDa1A7_Type**

namespace	urn:www.agenziaentrate.gov.it:specificheTecniche:sco:730	
type	restriction of DatoN1_Type	
facets	Kind	Value
	pattern	[1-9]
	enumeration	1
	enumeration	2
	enumeration	3
	enumeration	4
	enumeration	5
	enumeration	7

simpleType **Periodo_Spese_Ristrutturazione_Type**

namespace	urn:www.agenziaentrate.gov.it:specificheTecniche:sco:730	
type	restriction of DatoN1_Type	
facets	Kind	Value
	pattern	[1-9]
	enumeration	1
	enumeration	2
	enumeration	4

simpleType **Rate10_Type**

namespace	urn:www.agenziaentrate.gov.it:specificheTecniche:sco:730	
type	restriction of DatoNP_Type	
facets	Kind	Value
	pattern	[1-9]{1}[0-9]*
	enumeration	1
	enumeration	2
	enumeration	3
	enumeration	4
	enumeration	5
	enumeration	6
	enumeration	7
	enumeration	8
	enumeration	9
enumeration	10	

simpleType Rate5_Type

namespace	urn:www.agenziaentrate.gov.it:specificheTecniche:sco:730	
type	restriction of DatoNP_Type	
facets	Kind	Value
	pattern	[1-9]{1}[0-9]*
	enumeration	5

simpleType Rate_Risparmio_Energetico_Type

namespace	urn:www.agenziaentrate.gov.it:specificheTecniche:sco:730	
type	restriction of DatoNP_Type	
facets	Kind	Value
	pattern	[1-9]{1}[0-9]*
	enumeration	3
	enumeration	4
	enumeration	5
	enumeration	6
	enumeration	7
	enumeration	8
	enumeration	9
	enumeration	10

simpleType Reintegro_Totale_Parziale_Type

namespace	urn:www.agenziaentrate.gov.it:specificheTecniche:sco:730	
type	restriction of DatoN1_Type	
facets	Kind	Value
	pattern	[1-9]
	enumeration	1
	enumeration	2

simpleType Rettificativo_Type

namespace	urn:www.agenziaentrate.gov.it:specificheTecniche:sco:730	
type	restriction of DatoN1_Type	
facets	Kind	Value
	pattern	[1-9]
	enumeration	1
	enumeration	2
	enumeration	3

simpleType Rideterminazione_Rate_Type

namespace	urn:www.agenziaentrate.gov.it:specificheTecniche:sco:730	
type	restriction of DatoNP_Type	
facets	Kind	Value
	pattern	[1-9]{1}[0-9]*
	enumeration	10

simpleType **Ripart_Risparmio_Energetico_Type**

namespace	urn:www.agenziaentrate.gov.it:specificheTecniche:sco:730										
type	restriction of DatoNP_Type										
facets	<table border="1"> <thead> <tr> <th>Kind</th> <th>Value</th> </tr> </thead> <tbody> <tr> <td>pattern</td> <td>[1-9]{1}[0-9]*</td> </tr> <tr> <td>enumeration</td> <td>8</td> </tr> <tr> <td>enumeration</td> <td>9</td> </tr> <tr> <td>enumeration</td> <td>10</td> </tr> </tbody> </table>	Kind	Value	pattern	[1-9]{1}[0-9]*	enumeration	8	enumeration	9	enumeration	10
Kind	Value										
pattern	[1-9]{1}[0-9]*										
enumeration	8										
enumeration	9										
enumeration	10										

simpleType **Serie_Registrazione_Contratto_Type**

namespace	urn:www.agenziaentrate.gov.it:specificheTecniche:sco:730														
type	restriction of DatoAN_Type														
facets	<table border="1"> <thead> <tr> <th>Kind</th> <th>Value</th> </tr> </thead> <tbody> <tr> <td>pattern</td> <td>(([0-9A-Z-] \&quot;){1}([0-9A-Z&amp;] ' \\-\\. . / ° \\v\\(\\v)À È É Ì Ò Ù Û &quot; \\N \\+)*</td> </tr> <tr> <td>enumeration</td> <td>3</td> </tr> <tr> <td>enumeration</td> <td>3A</td> </tr> <tr> <td>enumeration</td> <td>3B</td> </tr> <tr> <td>enumeration</td> <td>3P</td> </tr> <tr> <td>enumeration</td> <td>3T</td> </tr> </tbody> </table>	Kind	Value	pattern	(([0-9A-Z-] \"){1}([0-9A-Z&] ' \\-\\. . / ° \\v\\(\\v)À È É Ì Ò Ù Û " \\N \\+)*	enumeration	3	enumeration	3A	enumeration	3B	enumeration	3P	enumeration	3T
Kind	Value														
pattern	(([0-9A-Z-] \"){1}([0-9A-Z&] ' \\-\\. . / ° \\v\\(\\v)À È É Ì Ò Ù Û " \\N \\+)*														
enumeration	3														
enumeration	3A														
enumeration	3B														
enumeration	3P														
enumeration	3T														

simpleType **Stato_Civile_Type**

namespace	urn:www.agenziaentrate.gov.it:specificheTecniche:sco:730								
type	restriction of DatoNP_Type								
facets	<table border="1"> <thead> <tr> <th>Kind</th> <th>Value</th> </tr> </thead> <tbody> <tr> <td>pattern</td> <td>[1-9]{1}[0-9]*</td> </tr> <tr> <td>enumeration</td> <td>7</td> </tr> <tr> <td>enumeration</td> <td>8</td> </tr> </tbody> </table>	Kind	Value	pattern	[1-9]{1}[0-9]*	enumeration	7	enumeration	8
Kind	Value								
pattern	[1-9]{1}[0-9]*								
enumeration	7								
enumeration	8								

simpleType **Terreni_Urbano_Type**

namespace	urn:www.agenziaentrate.gov.it:specificheTecniche:sco:730								
type	restriction of DatoAN_Type								
facets	<table border="1"> <thead> <tr> <th>Kind</th> <th>Value</th> </tr> </thead> <tbody> <tr> <td>pattern</td> <td>(([0-9A-Z-] \&quot;){1}([0-9A-Z&amp;] ' \\-\\. . / ° \\v\\(\\v)À È É Ì Ò Ù Û &quot; \\N \\+)*</td> </tr> <tr> <td>enumeration</td> <td>T</td> </tr> <tr> <td>enumeration</td> <td>U</td> </tr> </tbody> </table>	Kind	Value	pattern	(([0-9A-Z-] \"){1}([0-9A-Z&] ' \\-\\. . / ° \\v\\(\\v)À È É Ì Ò Ù Û " \\N \\+)*	enumeration	T	enumeration	U
Kind	Value								
pattern	(([0-9A-Z-] \"){1}([0-9A-Z&] ' \\-\\. . / ° \\v\\(\\v)À È É Ì Ò Ù Û " \\N \\+)*								
enumeration	T								
enumeration	U								

simpleType **Tipo_Inquilino_Type**

namespace	urn:www.agenziaentrate.gov.it:specificheTecniche:sco:730												
type	restriction of DatoNP_Type												
facets	<table border="1"> <thead> <tr> <th>Kind</th> <th>Value</th> </tr> </thead> <tbody> <tr> <td>pattern</td> <td>[1-9]{1}[0-9]*</td> </tr> <tr> <td>enumeration</td> <td>1</td> </tr> <tr> <td>enumeration</td> <td>2</td> </tr> <tr> <td>enumeration</td> <td>3</td> </tr> <tr> <td>enumeration</td> <td>4</td> </tr> </tbody> </table>	Kind	Value	pattern	[1-9]{1}[0-9]*	enumeration	1	enumeration	2	enumeration	3	enumeration	4
Kind	Value												
pattern	[1-9]{1}[0-9]*												
enumeration	1												
enumeration	2												
enumeration	3												
enumeration	4												

simpleType **Tipo_Intervento_Type**

namespace	urn:www.agenziaentrate.gov.it:specificheTecniche:sco:730	
type	restriction of DatoN1_Type	
facets	Kind	Value
	pattern	[1-9]
	enumeration	1
	enumeration	2
	enumeration	3
	enumeration	4
	enumeration	5
	enumeration	6

simpleType **Tipo_Reddito_Da1a12_Type**

namespace	urn:www.agenziaentrate.gov.it:specificheTecniche:sco:730	
type	restriction of DatoNP_Type	
facets	Kind	Value
	pattern	[1-9]{1}[0-9]*
	enumeration	1
	enumeration	2
	enumeration	3
	enumeration	4
	enumeration	5
	enumeration	6
	enumeration	7
	enumeration	8
	enumeration	9
	enumeration	10
	enumeration	11
	enumeration	12

simpleType **Tipo_Reddito_Da1a3_Type**

namespace	urn:www.agenziaentrate.gov.it:specificheTecniche:sco:730	
type	restriction of DatoN1_Type	
facets	Kind	Value
	pattern	[1-9]
	enumeration	1
	enumeration	2
	enumeration	3

simpleType **Tipo_Reddito_Da1a4_Type**

namespace	urn:www.agenziaentrate.gov.it:specificheTecniche:sco:730	
type	restriction of DatoN1_Type	
facets	Kind	Value
	pattern	[1-9]
	enumeration	1
	enumeration	2
	enumeration	3
	enumeration	4

simpleType **Tipo_Reddito_Da1a6_Type**

namespace	urn:www.agenziaentrate.gov.it:specificheTecniche:sco:730	
-----------	--	--

type	restriction of DatoN1_Type																
facets	<table border="1"> <thead> <tr> <th>Kind</th> <th>Value</th> </tr> </thead> <tbody> <tr> <td>pattern</td> <td>[1-9]</td> </tr> <tr> <td>enumeration</td> <td>1</td> </tr> <tr> <td>enumeration</td> <td>2</td> </tr> <tr> <td>enumeration</td> <td>3</td> </tr> <tr> <td>enumeration</td> <td>4</td> </tr> <tr> <td>enumeration</td> <td>5</td> </tr> <tr> <td>enumeration</td> <td>6</td> </tr> </tbody> </table>	Kind	Value	pattern	[1-9]	enumeration	1	enumeration	2	enumeration	3	enumeration	4	enumeration	5	enumeration	6
Kind	Value																
pattern	[1-9]																
enumeration	1																
enumeration	2																
enumeration	3																
enumeration	4																
enumeration	5																
enumeration	6																

simpleType **Tipo_Reddito_Da1a8_Type**

namespace	urn:www.agenziaentrate.gov.it:specificheTecniche:sco:730																				
type	restriction of DatoNP_Type																				
facets	<table border="1"> <thead> <tr> <th>Kind</th> <th>Value</th> </tr> </thead> <tbody> <tr> <td>pattern</td> <td>[1-9]{1}[0-9]*</td> </tr> <tr> <td>enumeration</td> <td>1</td> </tr> <tr> <td>enumeration</td> <td>2</td> </tr> <tr> <td>enumeration</td> <td>3</td> </tr> <tr> <td>enumeration</td> <td>4</td> </tr> <tr> <td>enumeration</td> <td>5</td> </tr> <tr> <td>enumeration</td> <td>6</td> </tr> <tr> <td>enumeration</td> <td>7</td> </tr> <tr> <td>enumeration</td> <td>8</td> </tr> </tbody> </table>	Kind	Value	pattern	[1-9]{1}[0-9]*	enumeration	1	enumeration	2	enumeration	3	enumeration	4	enumeration	5	enumeration	6	enumeration	7	enumeration	8
Kind	Value																				
pattern	[1-9]{1}[0-9]*																				
enumeration	1																				
enumeration	2																				
enumeration	3																				
enumeration	4																				
enumeration	5																				
enumeration	6																				
enumeration	7																				
enumeration	8																				

simpleType **Tipo_Reddito_Da1a9_Type**

namespace	urn:www.agenziaentrate.gov.it:specificheTecniche:sco:730																						
type	restriction of DatoNP_Type																						
facets	<table border="1"> <thead> <tr> <th>Kind</th> <th>Value</th> </tr> </thead> <tbody> <tr> <td>pattern</td> <td>[1-9]{1}[0-9]*</td> </tr> <tr> <td>enumeration</td> <td>1</td> </tr> <tr> <td>enumeration</td> <td>2</td> </tr> <tr> <td>enumeration</td> <td>3</td> </tr> <tr> <td>enumeration</td> <td>4</td> </tr> <tr> <td>enumeration</td> <td>5</td> </tr> <tr> <td>enumeration</td> <td>6</td> </tr> <tr> <td>enumeration</td> <td>7</td> </tr> <tr> <td>enumeration</td> <td>8</td> </tr> <tr> <td>enumeration</td> <td>9</td> </tr> </tbody> </table>	Kind	Value	pattern	[1-9]{1}[0-9]*	enumeration	1	enumeration	2	enumeration	3	enumeration	4	enumeration	5	enumeration	6	enumeration	7	enumeration	8	enumeration	9
Kind	Value																						
pattern	[1-9]{1}[0-9]*																						
enumeration	1																						
enumeration	2																						
enumeration	3																						
enumeration	4																						
enumeration	5																						
enumeration	6																						
enumeration	7																						
enumeration	8																						
enumeration	9																						

simpleType **Tipologia_Soggetto_Ass_Fisc_Type**

namespace	urn:www.agenziaentrate.gov.it:specificheTecniche:sco:730														
type	restriction of DatoN1_Type														
facets	<table border="1"> <thead> <tr> <th>Kind</th> <th>Value</th> </tr> </thead> <tbody> <tr> <td>pattern</td> <td>[1-9]</td> </tr> <tr> <td>enumeration</td> <td>1</td> </tr> <tr> <td>enumeration</td> <td>2</td> </tr> <tr> <td>enumeration</td> <td>3</td> </tr> <tr> <td>enumeration</td> <td>4</td> </tr> <tr> <td>enumeration</td> <td>5</td> </tr> </tbody> </table>	Kind	Value	pattern	[1-9]	enumeration	1	enumeration	2	enumeration	3	enumeration	4	enumeration	5
Kind	Value														
pattern	[1-9]														
enumeration	1														
enumeration	2														
enumeration	3														
enumeration	4														
enumeration	5														

simpleType **Titolo_Terreno_Type**

namespace	urn:www.agenziaentrate.gov.it:specificheTecniche:sco:730
-----------	--

type	restriction of DatoNP_Type	
facets	Kind	Value
	pattern	[1-9]{1}[0-9]*
	enumeration	1
	enumeration	2
	enumeration	3
	enumeration	4
	enumeration	5
	enumeration	6
	enumeration	7
	enumeration	10

simpleType [Utilizzo_Fabbricato_Type](#)

namespace	urn:www.agenziaentrate.gov.it:specificheTecniche:sco:730	
type	restriction of DatoNP_Type	
facets	Kind	Value
	pattern	[1-9]{1}[0-9]*
	enumeration	1
	enumeration	2
	enumeration	3
	enumeration	4
	enumeration	5
	enumeration	8
	enumeration	9
	enumeration	10
	enumeration	11
	enumeration	12
	enumeration	14
	enumeration	15
	enumeration	16
	enumeration	17

element [Documento](#)

diagram					
namespace	urn:www.agenziaentrate.gov.it:specificheTecniche:common				
type	Documento_Type				
attributes	Name	Type	Use	Default	Fixed
	identificativo	Identificativo_Type	required		

complexType [Documento_Type](#)

diagram					
---------	--	--	--	--	--

namespace	urn:www.agenziaentrate.gov.it:specificheTecniche:common				
attributes	Name identificativo	Type Identificativo_Type	Use required	Default	Fixed

attribute **Documento_Type/@identificativo**

type	Identificativo_Type				
facets	Kind	Value			
	pattern	[0-9]{4}[1-9] [0-9]{3}[1-9] [0-9]{2}[1-9] [0-9]{2} [0-9][1-9] [0-9]{3} [1-9][0-9]{4}			

simpleType **Identificativo_Type**

namespace	urn:www.agenziaentrate.gov.it:specificheTecniche:common				
type	restriction of xs:string				
facets	Kind	Value			
	pattern	[0-9]{4}[1-9] [0-9]{3}[1-9] [0-9]{2}[1-9] [0-9]{2} [0-9][1-9] [0-9]{3} [1-9][0-9]{4}			

complexType **Dati_Anagrafici_Type**

diagram					
namespace	urn:www.agenziaentrate.gov.it:specificheTecniche:sco:common				
children	Cognome Nome Sesso DataNascita ComuneNascita ProvinciaNascita				

element **Dati_Anagrafici_Type/Cognome**

diagram					
namespace	urn:www.agenziaentrate.gov.it:specificheTecniche:sco:common				
type	DatoAN_Type				
facets	Kind	Value			
	pattern	(([0-9A-Z-] \"){1}([0-9A-Z&:] [-\.,/ ^\(\)\] À É È Ì Ò Ù Ú " \N +)*			

element Dati_Anagrafici_Type/Nome

diagram	
namespace	urn:www.agenziaentrate.gov.it:specificheTecniche:sco:common
type	DatoAN_Type
facets	Kind Value pattern (([0-9A-Z\-\] "){1}([0-9A-Z&:] \-\ \., / \^\ \(\ \)\ À È É Ì Ò Ù Ü " \ \ \ +)*

element Dati_Anagrafici_Type/Sesso

diagram	
namespace	urn:www.agenziaentrate.gov.it:specificheTecniche:sco:common
type	Sesso_Type
facets	Kind Value pattern (([0-9A-Z\-\] "){1}([0-9A-Z&:] \-\ \., / \^\ \(\ \)\ À È É Ì Ò Ù Ü " \ \ \ +)* enumeration M enumeration F

element Dati_Anagrafici_Type/DataNascita

diagram	
namespace	urn:www.agenziaentrate.gov.it:specificheTecniche:sco:common
type	DatoDT_Type
facets	Kind Value pattern (((([0-9]{12}[0-9]{3}[01])(0[13578][10]12)\d{4})) ((([0-9]{11}[12][0-9]{30})(0[469][11]\d{4})) ((([0-9]{1}[0-9]{2}[0-8])(02)\d{4})) ((29)(02)([02468][048]00)) ((29)(02)([13579][26]00)) ((29)(02)([0-9][0-9][0][48])) ((29)(02)([0-9][0-9][2468][048])) ((29)(02)([0-9][0-9][13579][26]))))

element Dati_Anagrafici_Type/ComuneNascita

diagram	
namespace	urn:www.agenziaentrate.gov.it:specificheTecniche:sco:common
type	DatoAN_Type
facets	Kind Value pattern (([0-9A-Z\-\] "){1}([0-9A-Z&:] \-\ \., / \^\ \(\ \)\ À È É Ì Ò Ù Ü " \ \ \ +)*

element Dati_Anagrafici_Type/ProvinciaNascita

diagram	
namespace	urn:www.agenziaentrate.gov.it:specificheTecniche:sco:common
type	PN_Type

complexType Dati_Sottoscrittore_Type

diagram	
namespace	urn:www.agenziaentrate.gov.it:specificheTecniche:sco:common
children	CodiceFiscale CodiceCarica CodiceFiscaleSocieta DatiAnagrafici ResidenzaEstera Telefono DataCarica InizioProcedura ProceduraNonTerminata FineProcedura

element Dati_Sottoscrittore_Type/CodiceFiscale

diagram					
namespace	urn:www.agenziaentrate.gov.it:specificheTecniche:sco:common				
type	DatoCF_Type				
facets	<table border="1"> <thead> <tr> <th>Kind</th> <th>Value</th> </tr> </thead> <tbody> <tr> <td>pattern</td> <td>[0-9]{11}[A-Z]{6}[0-9LMNPQRSTU]{2}[A-Z]{1}[0-9LMNPQRSTU]{2}[A-Z]{1}[0-9LMNPQRSTU]{3}[A-Z]{1}</td> </tr> </tbody> </table>	Kind	Value	pattern	[0-9]{11}[A-Z]{6}[0-9LMNPQRSTU]{2}[A-Z]{1}[0-9LMNPQRSTU]{2}[A-Z]{1}[0-9LMNPQRSTU]{3}[A-Z]{1}
Kind	Value				
pattern	[0-9]{11}[A-Z]{6}[0-9LMNPQRSTU]{2}[A-Z]{1}[0-9LMNPQRSTU]{2}[A-Z]{1}[0-9LMNPQRSTU]{3}[A-Z]{1}				

element Dati_Sottoscrittore_Type/CodiceCarica

diagram													
namespace	urn:www.agenziaentrate.gov.it:specificheTecniche:sco:common												
type	Codice_Carica_Type												
facets	<table border="1"> <thead> <tr> <th>Kind</th> <th>Value</th> </tr> </thead> <tbody> <tr> <td>pattern</td> <td>[1-9]{1}[0-9]*</td> </tr> <tr> <td>enumeration</td> <td>1</td> </tr> <tr> <td>enumeration</td> <td>2</td> </tr> <tr> <td>enumeration</td> <td>3</td> </tr> <tr> <td>enumeration</td> <td>4</td> </tr> </tbody> </table>	Kind	Value	pattern	[1-9]{1}[0-9]*	enumeration	1	enumeration	2	enumeration	3	enumeration	4
Kind	Value												
pattern	[1-9]{1}[0-9]*												
enumeration	1												
enumeration	2												
enumeration	3												
enumeration	4												

enumeration	5
enumeration	6
enumeration	7
enumeration	8
enumeration	9
enumeration	10
enumeration	11
enumeration	12
enumeration	13
enumeration	14
enumeration	15

element **Dati_Sottoscrittore_Type/CodiceFiscaleSocieta**

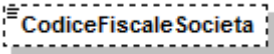
diagram	
namespace	urn:www.agenziaentrate.gov.it:specificheTecniche:sco:common
type	DatoCN_Type
facets	Kind Value pattern {0-9}{11}

element **Dati_Sottoscrittore_Type/DatiAnagrafici**

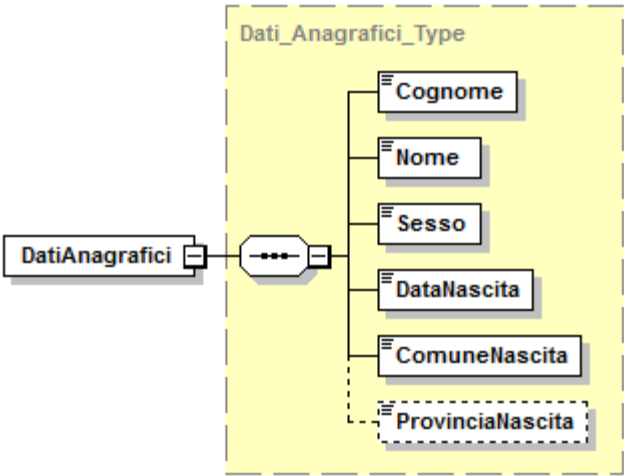
diagram	
namespace	urn:www.agenziaentrate.gov.it:specificheTecniche:sco:common
type	Dati_Anagrafici_Type
children	Cognome Nome Sesso DataNascita ComuneNascita ProvinciaNascita

element **Dati_Sottoscrittore_Type/ResidenzaEstera**

diagram	
namespace	urn:www.agenziaentrate.gov.it:specificheTecniche:sco:common
type	Residenza_Estera_Type
children	CodiceStatoEstero StatoFederato LocalitaEstero IndirizzoEstero

element **Dati_Sottoscrittore_Type/Telefono**

diagram					
namespace	urn:www.agenziaentrate.gov.it:specificheTecniche:sco:common				
type	DatoTL_Type				
facets	<table border="1"> <thead> <tr> <th>Kind</th> <th>Value</th> </tr> </thead> <tbody> <tr> <td>pattern</td> <td>[0-9]*</td> </tr> </tbody> </table>	Kind	Value	pattern	[0-9]*
Kind	Value				
pattern	[0-9]*				

element **Dati_Sottoscrittore_Type/DataCarica**

diagram					
namespace	urn:www.agenziaentrate.gov.it:specificheTecniche:sco:common				
type	DatoDT_Type				
facets	<table border="1"> <thead> <tr> <th>Kind</th> <th>Value</th> </tr> </thead> <tbody> <tr> <td>pattern</td> <td>((([0-9]{1,12}[0-9]{3,01})(0[13578][10]12\d{4})) ([0-9]{1,12}[0-9]{30}(0[469][11]\d{4})) ([0-9]{1,12}[0-9]{2[0-8]}(02\d{4})) ((29)(02)[02468][048]00)) ((29)(02)[13579][26]00)) ((29)(02)[0-9][0-9][0148])) ((29)(02)[0-9][0-9][2468][048])) ((29)(02)[0-9][0-9][13579][26]))</td> </tr> </tbody> </table>	Kind	Value	pattern	((([0-9]{1,12}[0-9]{3,01})(0[13578][10]12\d{4})) ([0-9]{1,12}[0-9]{30}(0[469][11]\d{4})) ([0-9]{1,12}[0-9]{2[0-8]}(02\d{4})) ((29)(02)[02468][048]00)) ((29)(02)[13579][26]00)) ((29)(02)[0-9][0-9][0148])) ((29)(02)[0-9][0-9][2468][048])) ((29)(02)[0-9][0-9][13579][26]))
Kind	Value				
pattern	((([0-9]{1,12}[0-9]{3,01})(0[13578][10]12\d{4})) ([0-9]{1,12}[0-9]{30}(0[469][11]\d{4})) ([0-9]{1,12}[0-9]{2[0-8]}(02\d{4})) ((29)(02)[02468][048]00)) ((29)(02)[13579][26]00)) ((29)(02)[0-9][0-9][0148])) ((29)(02)[0-9][0-9][2468][048])) ((29)(02)[0-9][0-9][13579][26]))				

element **Dati_Sottoscrittore_Type/InizioProcedura**

diagram					
namespace	urn:www.agenziaentrate.gov.it:specificheTecniche:sco:common				
type	DatoDT_Type				
facets	<table border="1"> <thead> <tr> <th>Kind</th> <th>Value</th> </tr> </thead> <tbody> <tr> <td>pattern</td> <td>((([0-9]{1,12}[0-9]{3,01})(0[13578][10]12\d{4})) ([0-9]{1,12}[0-9]{30}(0[469][11]\d{4})) ([0-9]{1,12}[0-9]{2[0-8]}(02\d{4})) ((29)(02)[02468][048]00)) ((29)(02)[13579][26]00)) ((29)(02)[0-9][0-9][0148])) ((29)(02)[0-9][0-9][2468][048])) ((29)(02)[0-9][0-9][13579][26]))</td> </tr> </tbody> </table>	Kind	Value	pattern	((([0-9]{1,12}[0-9]{3,01})(0[13578][10]12\d{4})) ([0-9]{1,12}[0-9]{30}(0[469][11]\d{4})) ([0-9]{1,12}[0-9]{2[0-8]}(02\d{4})) ((29)(02)[02468][048]00)) ((29)(02)[13579][26]00)) ((29)(02)[0-9][0-9][0148])) ((29)(02)[0-9][0-9][2468][048])) ((29)(02)[0-9][0-9][13579][26]))
Kind	Value				
pattern	((([0-9]{1,12}[0-9]{3,01})(0[13578][10]12\d{4})) ([0-9]{1,12}[0-9]{30}(0[469][11]\d{4})) ([0-9]{1,12}[0-9]{2[0-8]}(02\d{4})) ((29)(02)[02468][048]00)) ((29)(02)[13579][26]00)) ((29)(02)[0-9][0-9][0148])) ((29)(02)[0-9][0-9][2468][048])) ((29)(02)[0-9][0-9][13579][26]))				

element **Dati_Sottoscrittore_Type/ProceduraNonTerminata**

diagram	
namespace	urn:www.agenziaentrate.gov.it:specificheTecniche:sco:common
type	DatoCB_Type
facets	Kind Value pattern [01]

element **Dati_Sottoscrittore_Type/FineProcedura**

diagram	
namespace	urn:www.agenziaentrate.gov.it:specificheTecniche:sco:common
type	DatoDT_Type
facets	Kind Value pattern (((([0-9][12][0-9][301])(0[13578]1012)\d{4})))(((0[1-9][12][0-9][30](0[469]11)\d{4})))(((0[1-9]1[0-9]2[0-8])(02)\d{4})))(((29)(02)([02468][048]00)))(((29)(02)([13579][26]00)))(((29)(02)([0-9][0-9][0][48])))(((29)(02)([0-9][0-9][2468][048])))(((29)(02)([0-9][0-9][13579][26])))

complexType **Domicilio_EE_Type**

diagram	
namespace	urn:www.agenziaentrate.gov.it:specificheTecniche:sco:common
children	Comune Provincia CodiceComune Indirizzo Cap DataVariazione

element **Domicilio_EE_Type/Comune**

diagram	
namespace	urn:www.agenziaentrate.gov.it:specificheTecniche:sco:common
type	DatoAN_Type
facets	Kind Value pattern (([0-9A-Z-] \"){1}([0-9A-Z&:] \- \., / \^\(\ \)\ À È É Ì Ò Ù Û " \ \\ / +)*

element Domicilio_EE_Type/Provincia

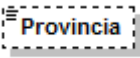
diagram	
namespace	urn:www.agenziaentrate.gov.it:specificheTecniche:sco:common
type	PE_Type

element Domicilio_EE_Type/CodiceComune

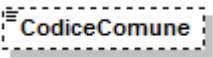
diagram					
namespace	urn:www.agenziaentrate.gov.it:specificheTecniche:sco:common				
type	DatoAN_Type				
facets	<table border="0"> <tr> <td>Kind</td> <td>Value</td> </tr> <tr> <td>pattern</td> <td>(([0-9A-Z\-\]&quot;){1}([0-9A-Z&amp;#39;] " \- \., / "^\(\ \) À É È Ì Ò Ù Û &quot; \ \\ +)*</td> </tr> </table>	Kind	Value	pattern	(([0-9A-Z\-\]"){1}([0-9A-Z&#39;] " \- \., / "^\(\ \) À É È Ì Ò Ù Û " \ \\ +)*
Kind	Value				
pattern	(([0-9A-Z\-\]"){1}([0-9A-Z&#39;] " \- \., / "^\(\ \) À É È Ì Ò Ù Û " \ \\ +)*				

element Domicilio_EE_Type/Indirizzo

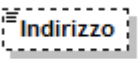
diagram					
namespace	urn:www.agenziaentrate.gov.it:specificheTecniche:sco:common				
type	DatoAN_Type				
facets	<table border="0"> <tr> <td>Kind</td> <td>Value</td> </tr> <tr> <td>pattern</td> <td>(([0-9A-Z\-\]&quot;){1}([0-9A-Z&amp;#39;] " \- \., / "^\(\ \) À É È Ì Ò Ù Û &quot; \ \\ +)*</td> </tr> </table>	Kind	Value	pattern	(([0-9A-Z\-\]"){1}([0-9A-Z&#39;] " \- \., / "^\(\ \) À É È Ì Ò Ù Û " \ \\ +)*
Kind	Value				
pattern	(([0-9A-Z\-\]"){1}([0-9A-Z&#39;] " \- \., / "^\(\ \) À É È Ì Ò Ù Û " \ \\ +)*				

element Domicilio_EE_Type/Cap

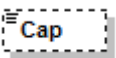
diagram					
namespace	urn:www.agenziaentrate.gov.it:specificheTecniche:sco:common				
type	DatoCP_Type				
facets	<table border="0"> <tr> <td>Kind</td> <td>Value</td> </tr> <tr> <td>pattern</td> <td>[0-9]{5}</td> </tr> </table>	Kind	Value	pattern	[0-9]{5}
Kind	Value				
pattern	[0-9]{5}				

element Domicilio_EE_Type/DataVariazione

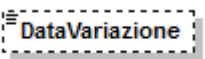
diagram					
namespace	urn:www.agenziaentrate.gov.it:specificheTecniche:sco:common				
type	DatoD6_Type				
facets	<table border="0"> <tr> <td>Kind</td> <td>Value</td> </tr> <tr> <td>pattern</td> <td>(([0-9])([10-2]))((19 20)[0-9][0-9])</td> </tr> </table>	Kind	Value	pattern	(([0-9])([10-2]))((19 20)[0-9][0-9])
Kind	Value				
pattern	(([0-9])([10-2]))((19 20)[0-9][0-9])				

complexType **Domicilio_Fiscale_Type**

diagram	
namespace	urn:www.agenziaentrate.gov.it:specificheTecniche:sco:common
type	extension of Domicilio_Ita_Type
children	Comune Provincia CodiceComune Indirizzo Cap DataVariazione

element **Domicilio_Fiscale_Type/DataVariazione**

diagram					
namespace	urn:www.agenziaentrate.gov.it:specificheTecniche:sco:common				
type	DatoD6_Type				
facets	<table border="1"> <thead> <tr> <th>Kind</th> <th>Value</th> </tr> </thead> <tbody> <tr> <td>pattern</td> <td>((0[0-9]) (1[0-2]))((19 20)[0-9][0-9])</td> </tr> </tbody> </table>	Kind	Value	pattern	((0[0-9]) (1[0-2]))((19 20)[0-9][0-9])
Kind	Value				
pattern	((0[0-9]) (1[0-2]))((19 20)[0-9][0-9])				

complexType **Domicilio_Ita_Type**

diagram	
namespace	urn:www.agenziaentrate.gov.it:specificheTecniche:sco:common
children	Comune Provincia CodiceComune Indirizzo Cap

element Domicilio_Ita_Type/Comune

diagram	
namespace	urn:www.agenziaentrate.gov.it:specificheTecniche:sco:common
type	DatoAN_Type
facets	Kind Value pattern ([0-9A-Z\-\-]"){1}([0-9A-Z&:] \- \., / \^\(\ \) À È É Ì Ò Ù Û " \ \\ \ +)*

element Domicilio_Ita_Type/Provincia

diagram	
namespace	urn:www.agenziaentrate.gov.it:specificheTecniche:sco:common
type	PR_Type

element Domicilio_Ita_Type/CodiceComune

diagram	
namespace	urn:www.agenziaentrate.gov.it:specificheTecniche:sco:common
type	DatoAN_Type
facets	Kind Value pattern ([0-9A-Z\-\-]"){1}([0-9A-Z&:] \- \., / \^\(\ \) À È É Ì Ò Ù Û " \ \\ \ +)*

element Domicilio_Ita_Type/Indirizzo

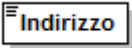
diagram	
namespace	urn:www.agenziaentrate.gov.it:specificheTecniche:sco:common
type	DatoAN_Type
facets	Kind Value pattern ([0-9A-Z\-\-]"){1}([0-9A-Z&:] \- \., / \^\(\ \) À È É Ì Ò Ù Û " \ \\ \ +)*

element Domicilio_Ita_Type/Cap

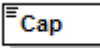
diagram	
namespace	urn:www.agenziaentrate.gov.it:specificheTecniche:sco:common
type	DatoCP_Type
facets	Kind Value pattern [0-9]{5}

complexType Firma_Revisione_Type

diagram	
namespace	urn:www.agenziaentrate.gov.it:specificheTecniche:sco:common
children	Soggetto CodiceFiscale FirmaDichiarante

element Firma_Revisione_Type/Soggetto

diagram					
namespace	urn:www.agenziaentrate.gov.it:specificheTecniche:sco:common				
type	restriction of DatoNP_Type				
facets	<table border="1"> <tr> <td>Kind</td> <td>Value</td> </tr> <tr> <td>pattern</td> <td>[1-4]</td> </tr> </table>	Kind	Value	pattern	[1-4]
Kind	Value				
pattern	[1-4]				

element Firma_Revisione_Type/CodiceFiscale

diagram					
namespace	urn:www.agenziaentrate.gov.it:specificheTecniche:sco:common				
type	DatoCF_Type				
facets	<table border="1"> <tr> <td>Kind</td> <td>Value</td> </tr> <tr> <td>pattern</td> <td>[0-9]{11}[A-Z]{6}[0-9LMNPQRSTU]{2}[A-Z]{1}[0-9LMNPQRSTU]{2}[A-Z]{1}[0-9LMNPQRSTU]{3}[A-Z]{1}</td> </tr> </table>	Kind	Value	pattern	[0-9]{11}[A-Z]{6}[0-9LMNPQRSTU]{2}[A-Z]{1}[0-9LMNPQRSTU]{2}[A-Z]{1}[0-9LMNPQRSTU]{3}[A-Z]{1}
Kind	Value				
pattern	[0-9]{11}[A-Z]{6}[0-9LMNPQRSTU]{2}[A-Z]{1}[0-9LMNPQRSTU]{2}[A-Z]{1}[0-9LMNPQRSTU]{3}[A-Z]{1}				

element Firma_Revisione_Type/FirmaDichiarante

diagram					
namespace	urn:www.agenziaentrate.gov.it:specificheTecniche:sco:common				
type	DatoCB_Type				
facets	<table border="1"> <tr> <td>Kind</td> <td>Value</td> </tr> <tr> <td>pattern</td> <td>[01]</td> </tr> </table>	Kind	Value	pattern	[01]
Kind	Value				
pattern	[01]				

complexType Firma_Type

diagram	
namespace	urn:www.agenziaentrate.gov.it:specificheTecniche:sco:common

children	Firma CodiceFiscale
----------	---

element Firma_Type/Firma

diagram	
namespace	urn:www.agenziaentrate.gov.it:specificheTecniche:sco:common
type	DatoCB_Type
facets	Kind Value pattern [01]

element Firma_Type/CodiceFiscale

diagram	
namespace	urn:www.agenziaentrate.gov.it:specificheTecniche:sco:common
type	restriction of xs:string
facets	Kind Value pattern (([0-9A-Z-])"){0,1}([0-9A-Z&#x2011;] ' \\. , \\s ' ^\\(\\) À È É Ì Ò Ù Û " \\N \\+)*

complexType Frontespizio_Type

diagram	
namespace	urn:www.agenziaentrate.gov.it:specificheTecniche:sco:common
children	SoggettoFiscale

element Frontespizio_Type/SoggettoFiscale

diagram	
namespace	urn:www.agenziaentrate.gov.it:specificheTecniche:sco:common
type	Soggetto_Fiscale_Type
children	CodiceFiscale Email Telefono Fax

complexType Impegno_A_Trasmettere_Type

diagram	
namespace	urn:www.agenziaentrate.gov.it:specificheTecniche:sco:common
children	CFintermediario NumerolscrAlboCAF ImpegnoATrasmettere RicezioneAvvisoTelem DataImpegno FirmaIntermediario

element Impegno_A_Trasmettere_Type/CFintermediario

diagram					
namespace	urn:www.agenziaentrate.gov.it:specificheTecniche:sco:common				
type	DatoCF_Type				
facets	<table border="1"> <thead> <tr> <th>Kind</th> <th>Value</th> </tr> </thead> <tbody> <tr> <td>pattern</td> <td>[0-9]{11}[A-Z]{6}[0-9LMNPQRSTU]{2}[A-Z]{1}[0-9LMNPQRSTU]{2}[A-Z]{1}[0-9LMNPQRSTU]{3}[A-Z]{1}</td> </tr> </tbody> </table>	Kind	Value	pattern	[0-9]{11}[A-Z]{6}[0-9LMNPQRSTU]{2}[A-Z]{1}[0-9LMNPQRSTU]{2}[A-Z]{1}[0-9LMNPQRSTU]{3}[A-Z]{1}
Kind	Value				
pattern	[0-9]{11}[A-Z]{6}[0-9LMNPQRSTU]{2}[A-Z]{1}[0-9LMNPQRSTU]{2}[A-Z]{1}[0-9LMNPQRSTU]{3}[A-Z]{1}				

element Impegno_A_Trasmettere_Type/NumerolscrAlboCAF

diagram					
namespace	urn:www.agenziaentrate.gov.it:specificheTecniche:sco:common				
type	restriction of DatoNU_Type				
facets	<table border="1"> <thead> <tr> <th>Kind</th> <th>Value</th> </tr> </thead> <tbody> <tr> <td>pattern</td> <td>(\[1-9\]\ [1-9]\)[0-9]*</td> </tr> </tbody> </table>	Kind	Value	pattern	(\[1-9\]\ [1-9]\)[0-9]*
Kind	Value				
pattern	(\[1-9\]\ [1-9]\)[0-9]*				

element Impegno_A_Trasmettere_Type/ImpegnoATrasmettere

diagram									
namespace	urn:www.agenziaentrate.gov.it:specificheTecniche:sco:common								
type	restriction of DatoNP_Type								
facets	<table border="1"> <thead> <tr> <th>Kind</th> <th>Value</th> </tr> </thead> <tbody> <tr> <td>pattern</td> <td>1 2</td> </tr> <tr> <td>enumeration</td> <td>1</td> </tr> <tr> <td>enumeration</td> <td>2</td> </tr> </tbody> </table>	Kind	Value	pattern	1 2	enumeration	1	enumeration	2
Kind	Value								
pattern	1 2								
enumeration	1								
enumeration	2								

element **Impegno_A_Trasmettere_Type/RicezioneAvvisoTelem**

diagram	
namespace	urn:www.agenziaentrate.gov.it:specificheTecniche:sco:common
type	DatoCB_Type
facets	Kind Value pattern [01]

element **Impegno_A_Trasmettere_Type/DatalImpegno**

diagram	
namespace	urn:www.agenziaentrate.gov.it:specificheTecniche:sco:common
type	DatoDT_Type
facets	Kind Value pattern (((([0-9][12][0-9][3][01])([0-9][13578][10][12](\d{4})))([0-9][1-9][12][0-9][30](0[469][11](\d{4})))([0-9][1-9][1][0-9][2][0-8])(02)(\d{4})))([0-9][29][02][02468][048][00])([0-9][29][02][13579][26][00])([0-9][29][02][0-9][0][048])([0-9][29][02][0-9][2468][048])([0-9][29][02][0-9][13579][26])))

element **Impegno_A_Trasmettere_Type/FirmaIntermediario**

diagram	
namespace	urn:www.agenziaentrate.gov.it:specificheTecniche:sco:common
type	DatoCB_Type
facets	Kind Value pattern [01]

complexType **Persone_Fisiche_Type**

diagram	
namespace	urn:www.agenziaentrate.gov.it:specificheTecniche:sco:common
children	DatiAnagrafici ResidenzaAnagrafica

element **Persone_Fisiche_Type/DatiAnagrafici**

diagram	
namespace	urn:www.agenziaentrate.gov.it:specificheTecniche:sco:common
type	Dati_Anagrafici_Type
children	Cognome Nome Sesso DataNascita ComuneNascita ProvinciaNascita

element **Persone_Fisiche_Type/ResidenzaAnagrafica**

diagram	
namespace	urn:www.agenziaentrate.gov.it:specificheTecniche:sco:common
type	Residenza_Anagrafica_Type
children	Comune Provincia CodiceComune Indirizzo Cap DataVariazione

complexType **Residenza_Anagrafica_Type**

diagram	
namespace	urn:www.agenziaentrate.gov.it:specificheTecniche:sco:common
type	extension of Domicilio_Ita_Type
children	Comune Provincia CodiceComune Indirizzo Cap DataVariazione

element **Residenza_Anagrafica_Type/DataVariazione**

diagram					
namespace	urn:www.agenziaentrate.gov.it:specificheTecniche:sco:common				
type	DatoDT_Type				
facets	<table border="1"> <thead> <tr> <th>Kind</th> <th>Value</th> </tr> </thead> <tbody> <tr> <td>pattern</td> <td>((([0-9]{1,2} [0-9]{3} 01)))(0[13578][1012](\d{4}))(((0[1-9] 12 [0-9]{30})(0[469][11](\d{4})))((0[1-9] 1[0-9] 2[0-8])(02)(\d{4})))((29)(02)([02468][048]00))((29)(02)([13579][26]00))((29)(02)([0-9][0-9][48]))((29)(02)([0-9][2468][048]))((29)(02)([0-9][0-9][13579][26]))))</td> </tr> </tbody> </table>	Kind	Value	pattern	((([0-9]{1,2} [0-9]{3} 01)))(0[13578][1012](\d{4}))(((0[1-9] 12 [0-9]{30})(0[469][11](\d{4})))((0[1-9] 1[0-9] 2[0-8])(02)(\d{4})))((29)(02)([02468][048]00))((29)(02)([13579][26]00))((29)(02)([0-9][0-9][48]))((29)(02)([0-9][2468][048]))((29)(02)([0-9][0-9][13579][26]))))
Kind	Value				
pattern	((([0-9]{1,2} [0-9]{3} 01)))(0[13578][1012](\d{4}))(((0[1-9] 12 [0-9]{30})(0[469][11](\d{4})))((0[1-9] 1[0-9] 2[0-8])(02)(\d{4})))((29)(02)([02468][048]00))((29)(02)([13579][26]00))((29)(02)([0-9][0-9][48]))((29)(02)([0-9][2468][048]))((29)(02)([0-9][0-9][13579][26]))))				

complexType **Residenza_Estera_Type**

diagram	
namespace	urn:www.agenziaentrate.gov.it:specificheTecniche:sco:common
children	CodiceStatoEstero StatoFederato LocalitaEstero IndirizzoEstero

element **Residenza_Estera_Type/CodiceStatoEstero**

diagram	
namespace	urn:www.agenziaentrate.gov.it:specificheTecniche:sco:common
type	restriction of DatoAN_Type
facets	Kind Value pattern ([0-9A-Z\-\-]*)"}{1}([0-9A-Z&:] \- \., / ^ \^\(\ \)\ À É Ê Ì Ò Ù Ü " \ \ \ +)*

element **Residenza_Estera_Type/StatoFederato**

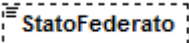
diagram	
namespace	urn:www.agenziaentrate.gov.it:specificheTecniche:sco:common
type	restriction of DatoAN_Type
facets	Kind Value pattern ([0-9A-Z\-\-]*)"}{1}([0-9A-Z&:] \- \., / ^ \^\(\ \)\ À É Ê Ì Ò Ù Ü " \ \ \ +)*

element **Residenza_Estera_Type/LocalitaEstero**

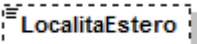
diagram	
namespace	urn:www.agenziaentrate.gov.it:specificheTecniche:sco:common
type	DatoAN_Type
facets	Kind Value pattern ([0-9A-Z\-\-]*)"}{1}([0-9A-Z&:] \- \., / ^ \^\(\ \)\ À É Ê Ì Ò Ù Ü " \ \ \ +)*

element **Residenza_Estera_Type/IndirizzoEstero**

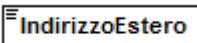
diagram	
namespace	urn:www.agenziaentrate.gov.it:specificheTecniche:sco:common
type	DatoAN_Type
facets	Kind Value pattern ([0-9A-Z\-\-]*)"}{1}([0-9A-Z&:] \- \., / ^ \^\(\ \)\ À É Ê Ì Ò Ù Ü " \ \ \ +)*

complexType **Soggetti_Diversi_Da_PF_Type**

diagram	
namespace	urn:www.agenziaentrate.gov.it:specificheTecniche:sco:common
children	Denominazione SedeLegale DomicilioFiscale DataApprovazioneBilancio TermineApprovazioneBilancio InizioPeriodoImposta FinePeriodoImposta Stato NaturaGiuridica Situazione

element **Soggetti_Diversi_Da_PF_Type/Denominazione**

diagram					
namespace	urn:www.agenziaentrate.gov.it:specificheTecniche:sco:common				
type	DatoAN_Type				
facets	<table border="0"> <tr> <td>Kind</td> <td>Value</td> </tr> <tr> <td>pattern</td> <td>(([0-9A-Z-] \&quot;){1}([0-9A-Z&amp;#39; ! @ _ ` \.\ / ° ' \(\) \) À É È Ì Ò Ù Û &quot; \ \\ / +)*</td> </tr> </table>	Kind	Value	pattern	(([0-9A-Z-] \"){1}([0-9A-Z&#39; ! @ _ ` \.\ / ° ' \(\) \) À É È Ì Ò Ù Û " \ \\ / +)*
Kind	Value				
pattern	(([0-9A-Z-] \"){1}([0-9A-Z&#39; ! @ _ ` \.\ / ° ' \(\) \) À É È Ì Ò Ù Û " \ \\ / +)*				

element **Soggetti_Diversi_Da_PF_Type/SedeLegale**

diagram	
namespace	urn:www.agenziaentrate.gov.it:specificheTecniche:sco:common
type	Domicilio_EE_Type
children	Comune Provincia CodiceComune Indirizzo Cap DataVariazione

element **Soggetti_Diversi_Da_PF_Type/DomicilioFiscale**

diagram	
namespace	urn:www.agenziaentrate.gov.it:specificheTecniche:sco:common
type	Domicilio_Fiscale_Type
children	Comune Provincia CodiceComune Indirizzo Cap DataVariazione

element **Soggetti_Diversi_Da_PF_Type/DataApprovazioneBilancio**

diagram	
namespace	urn:www.agenziaentrate.gov.it:specificheTecniche:sco:common

	enumeration	2
	enumeration	3
	enumeration	4

element **Soggetti_Diversi_Da_PF_Type/NaturaGiuridica**

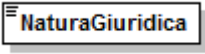
diagram		
namespace	urn:www.agenziaentrate.gov.it:specificheTecniche:sco:common	
type	Natura_Giuridica_Type	
facets	Kind	Value
	pattern	[1-9]{1}[0-9]*
	enumeration	1
	enumeration	2
	enumeration	3
	enumeration	4
	enumeration	5
	enumeration	6
	enumeration	7
	enumeration	8
	enumeration	9
	enumeration	10
	enumeration	11
	enumeration	12
	enumeration	13
	enumeration	14
	enumeration	15
	enumeration	16
	enumeration	17
	enumeration	18
	enumeration	19
	enumeration	20
	enumeration	21
	enumeration	22
	enumeration	23
	enumeration	24
	enumeration	25
	enumeration	26
	enumeration	27
	enumeration	28
	enumeration	29
	enumeration	30
	enumeration	31
	enumeration	32
	enumeration	33
	enumeration	34
	enumeration	35
	enumeration	36
	enumeration	37
	enumeration	38
	enumeration	39
	enumeration	40
	enumeration	41
	enumeration	42
	enumeration	43
	enumeration	44
	enumeration	45
	enumeration	50
	enumeration	51
	enumeration	52
	enumeration	53
	enumeration	54
	enumeration	55

	enumeration	56
	enumeration	57
	enumeration	58
	enumeration	59

element **Soggetti_Diversi_Da_PF_Type/Situazione**

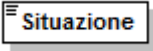
diagram		
namespace	urn:www.agenziaentrate.gov.it:specificheTecniche:sco:common	
type	Situazione Type	
facets	Kind	Value
	pattern	[1-9]{1}[0-9]*
	enumeration	1
	enumeration	2
	enumeration	3
	enumeration	4
	enumeration	5
	enumeration	6
	enumeration	7

complexType **Soggetti_Non_Residenti_Type**

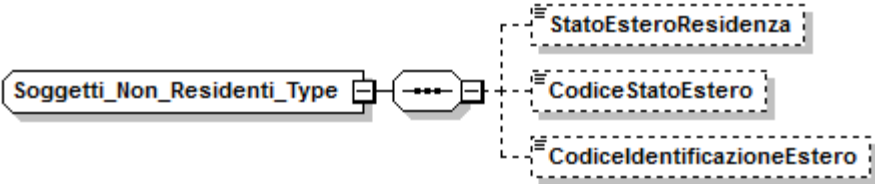
diagram		
namespace	urn:www.agenziaentrate.gov.it:specificheTecniche:sco:common	
children	StatoEsteroResidenza CodiceStatoEstero CodiceIdentificazioneEstero	

element **Soggetti_Non_Residenti_Type/StatoEsteroResidenza**

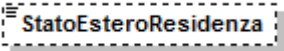
diagram		
namespace	urn:www.agenziaentrate.gov.it:specificheTecniche:sco:common	
type	DatoAN Type	
facets	Kind	Value
	pattern	([0-9A-Z\-_]"){1}([0-9A-Z&:] ' \- \., / "^\(\)\ À É È Ì Ò Ù Û "; \\ / +)*

element **Soggetti_Non_Residenti_Type/CodiceStatoEstero**

diagram		
namespace	urn:www.agenziaentrate.gov.it:specificheTecniche:sco:common	
type	DatoAN Type	

facets	Kind	Value
	pattern	(([0-9A-Z-])"){1}([0-9A-Z&#39;] ' \\- \\. , / ^\\^\\(\\ \\) À É È Ì Ò Ù Û " \\ \\ \\ +)*

element **Soggetti Non Residenti Type/CodicelIdentificazioneEestero**

diagram	
namespace	urn:www.agenziaentrate.gov.it:specificheTecniche:sco:common
type	DatoAN_Type
facets	Kind Value pattern (([0-9A-Z-])"){1}([0-9A-Z&#39;] ' \\- \\. , / ^\\^\\(\\ \\) À É È Ì Ò Ù Û " \\ \\ \\ +)*

complexType **Soggetto_Fiscale_Type**

diagram	
namespace	urn:www.agenziaentrate.gov.it:specificheTecniche:sco:common
children	CodiceFiscale Email Telefono Fax

element **Soggetto_Fiscale_Type/CodiceFiscale**

diagram	
namespace	urn:www.agenziaentrate.gov.it:specificheTecniche:sco:common
type	DatoCF_Type
facets	Kind Value pattern [0-9]{11}[A-Z]{6}[0-9LMNPQRSTU]{2}[A-Z]{1}[0-9LMNPQRSTU]{2}[A-Z]{1}[0-9LMNPQRSTU]{3}[A-Z]{1}

element **Soggetto_Fiscale_Type/Email**

diagram	
namespace	urn:www.agenziaentrate.gov.it:specificheTecniche:sco:common
type	DatoEM_Type
facets	Kind Value pattern [a-zA-Z0-9._%\\-"?^~=]+@[a-zA-Z0-9.\\-].{2,4}

element **Soggetto_Fiscale_Type/Telefono**

diagram	
namespace	urn:www.agenziaentrate.gov.it:specificheTecniche:sco:common
type	DatoTL_Type
facets	Kind Value pattern [0-9]*

element **Soggetto_Fiscale_Type/Fax**

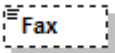
diagram	
namespace	urn:www.agenziaentrate.gov.it:specificheTecniche:sco:common
type	DatoTL_Type
facets	Kind Value pattern [0-9]*

complexType **Tipo_Dichiarazione_Type**

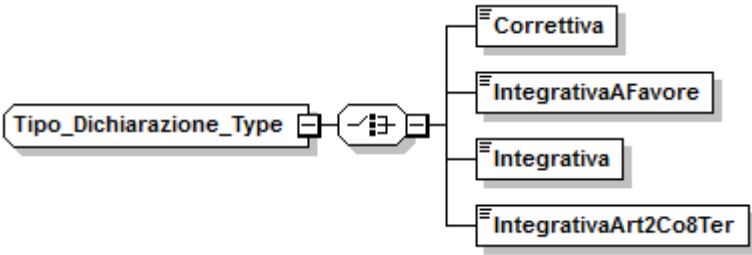
diagram	
namespace	urn:www.agenziaentrate.gov.it:specificheTecniche:sco:common
children	Correttiva IntegrativaAFavore Integrativa IntegrativaArt2Co8Ter

element **Tipo_Dichiarazione_Type/Correttiva**

diagram	
namespace	urn:www.agenziaentrate.gov.it:specificheTecniche:sco:common
type	DatoCB_Type
facets	Kind Value pattern [01]

element **Tipo_Dichiarazione_Type/IntegrativaAFavore**

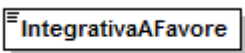
diagram	
namespace	urn:www.agenziaentrate.gov.it:specificheTecniche:sco:common

type	DatoCB_Type
facets	Kind Value pattern [01]

element [Tipo_Dichiarazione_Type/Integrativa](#)

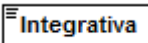
diagram	
namespace	urn:www.agenziaentrate.gov.it:specificheTecniche:sco:common
type	DatoCB_Type
facets	Kind Value pattern [01]

element [Tipo_Dichiarazione_Type/IntegrativaArt2Co8Ter](#)

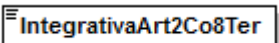
diagram	
namespace	urn:www.agenziaentrate.gov.it:specificheTecniche:sco:common
type	DatoCB_Type
facets	Kind Value pattern [01]

complexType [Visto_Conformita_Type](#)

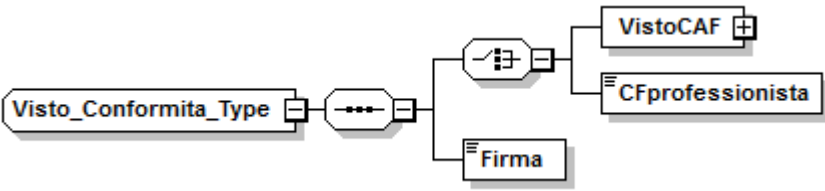
diagram	
namespace	urn:www.agenziaentrate.gov.it:specificheTecniche:sco:common
children	VistoCAF CFprofessionista Firma

element [Visto_Conformita_Type/VistoCAF](#)

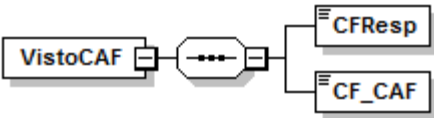
diagram	
namespace	urn:www.agenziaentrate.gov.it:specificheTecniche:sco:common
children	CFResp CF_CAF

element **Visto_Conformita_Type/VistoCAF/CFResp**

diagram					
namespace	urn:www.agenziaentrate.gov.it:specificheTecniche:sco:common				
type	DatoCF_Type				
facets	<table border="1"> <thead> <tr> <th>Kind</th> <th>Value</th> </tr> </thead> <tbody> <tr> <td>pattern</td> <td>[0-9]{11}[A-Z]{6}[0-9LMNPQRSTU]{2}[A-Z]{1}[0-9LMNPQRSTU]{2}[A-Z]{1}[0-9LMNPQRSTU]{3}[A-Z]{1}</td> </tr> </tbody> </table>	Kind	Value	pattern	[0-9]{11}[A-Z]{6}[0-9LMNPQRSTU]{2}[A-Z]{1}[0-9LMNPQRSTU]{2}[A-Z]{1}[0-9LMNPQRSTU]{3}[A-Z]{1}
Kind	Value				
pattern	[0-9]{11}[A-Z]{6}[0-9LMNPQRSTU]{2}[A-Z]{1}[0-9LMNPQRSTU]{2}[A-Z]{1}[0-9LMNPQRSTU]{3}[A-Z]{1}				

element **Visto_Conformita_Type/VistoCAF/CF_CAF**

diagram					
namespace	urn:www.agenziaentrate.gov.it:specificheTecniche:sco:common				
type	DatoCN_Type				
facets	<table border="1"> <thead> <tr> <th>Kind</th> <th>Value</th> </tr> </thead> <tbody> <tr> <td>pattern</td> <td>[0-9]{11}</td> </tr> </tbody> </table>	Kind	Value	pattern	[0-9]{11}
Kind	Value				
pattern	[0-9]{11}				

element **Visto_Conformita_Type/CFprofessionista**

diagram					
namespace	urn:www.agenziaentrate.gov.it:specificheTecniche:sco:common				
type	DatoCF_Type				
facets	<table border="1"> <thead> <tr> <th>Kind</th> <th>Value</th> </tr> </thead> <tbody> <tr> <td>pattern</td> <td>[0-9]{11}[A-Z]{6}[0-9LMNPQRSTU]{2}[A-Z]{1}[0-9LMNPQRSTU]{2}[A-Z]{1}[0-9LMNPQRSTU]{3}[A-Z]{1}</td> </tr> </tbody> </table>	Kind	Value	pattern	[0-9]{11}[A-Z]{6}[0-9LMNPQRSTU]{2}[A-Z]{1}[0-9LMNPQRSTU]{2}[A-Z]{1}[0-9LMNPQRSTU]{3}[A-Z]{1}
Kind	Value				
pattern	[0-9]{11}[A-Z]{6}[0-9LMNPQRSTU]{2}[A-Z]{1}[0-9LMNPQRSTU]{2}[A-Z]{1}[0-9LMNPQRSTU]{3}[A-Z]{1}				

element **Visto_Conformita_Type/Firma**

diagram					
namespace	urn:www.agenziaentrate.gov.it:specificheTecniche:sco:common				
type	DatoCB_Type				
facets	<table border="1"> <thead> <tr> <th>Kind</th> <th>Value</th> </tr> </thead> <tbody> <tr> <td>pattern</td> <td>[01]</td> </tr> </tbody> </table>	Kind	Value	pattern	[01]
Kind	Value				
pattern	[01]				

complexType **Scelta2PerMille_Type**

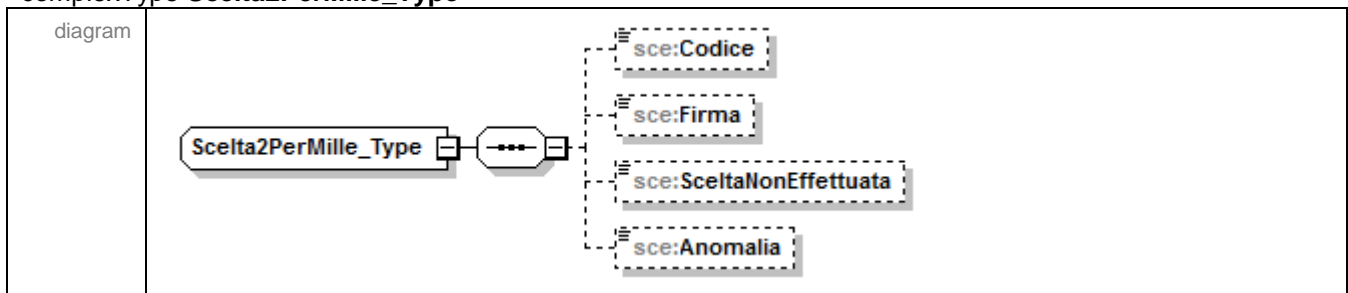

namespace	urn:www.agenziaentrate.gov.it:specificheTecniche:sco:sce
children	sce:Codice sce:Firma sce:SceltaNonEffettuata sce:Anomalia

element **Scelta2PerMille_Type/Codice**

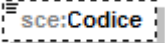
diagram					
namespace	urn:www.agenziaentrate.gov.it:specificheTecniche:sco:sce				
type	DatoAN_Type				
facets	<table border="1"> <tr> <td>Kind</td> <td>Value</td> </tr> <tr> <td>pattern</td> <td>([0-9A-Z\-\&quot;]{1}){([0-9A-Z&amp;:] ! - \., / ° ^\(\ \) À É È Ì Ò Ù Ú &quot; \ \ /+)*</td> </tr> </table>	Kind	Value	pattern	([0-9A-Z\-\"]{1}){([0-9A-Z&:] ! - \., / ° ^\(\ \) À É È Ì Ò Ù Ú " \ \ /+)*
Kind	Value				
pattern	([0-9A-Z\-\"]{1}){([0-9A-Z&:] ! - \., / ° ^\(\ \) À É È Ì Ò Ù Ú " \ \ /+)*				

element **Scelta2PerMille_Type/Firma**

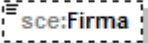
diagram					
namespace	urn:www.agenziaentrate.gov.it:specificheTecniche:sco:sce				
type	DatoCB_Type				
facets	<table border="1"> <tr> <td>Kind</td> <td>Value</td> </tr> <tr> <td>pattern</td> <td>[01]</td> </tr> </table>	Kind	Value	pattern	[01]
Kind	Value				
pattern	[01]				

element **Scelta2PerMille_Type/SceltaNonEffettuata**

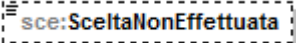
diagram					
namespace	urn:www.agenziaentrate.gov.it:specificheTecniche:sco:sce				
type	DatoCB_Type				
facets	<table border="1"> <tr> <td>Kind</td> <td>Value</td> </tr> <tr> <td>pattern</td> <td>[01]</td> </tr> </table>	Kind	Value	pattern	[01]
Kind	Value				
pattern	[01]				

element **Scelta2PerMille_Type/Anomalia**

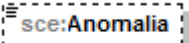
diagram													
namespace	urn:www.agenziaentrate.gov.it:specificheTecniche:sco:sce												
type	restriction of DatoN1_Type												
facets	<table border="1"> <tr> <td>Kind</td> <td>Value</td> </tr> <tr> <td>pattern</td> <td>[1-9]</td> </tr> <tr> <td>enumeration</td> <td>1</td> </tr> <tr> <td>enumeration</td> <td>2</td> </tr> <tr> <td>enumeration</td> <td>3</td> </tr> <tr> <td>enumeration</td> <td>4</td> </tr> </table>	Kind	Value	pattern	[1-9]	enumeration	1	enumeration	2	enumeration	3	enumeration	4
Kind	Value												
pattern	[1-9]												
enumeration	1												
enumeration	2												
enumeration	3												
enumeration	4												

complexType **Scelta2PerMilleAssCult_Type**

diagram	
namespace	urn:www.agenziaentrate.gov.it:specificheTecniche:sco:sce
children	sce:CodiceFiscale sce:Firma sce:SceltaNonEffettuata sce:Anomalia

element **Scelta2PerMilleAssCult_Type/CodiceFiscale**

diagram					
namespace	urn:www.agenziaentrate.gov.it:specificheTecniche:sco:sce				
type	DatoCN_Type				
facets	<table border="1"> <tr> <td>Kind</td> <td>Value</td> </tr> <tr> <td>pattern</td> <td>[0-9]{11}</td> </tr> </table>	Kind	Value	pattern	[0-9]{11}
Kind	Value				
pattern	[0-9]{11}				

element **Scelta2PerMilleAssCult_Type/Firma**

diagram					
namespace	urn:www.agenziaentrate.gov.it:specificheTecniche:sco:sce				
type	DatoCB_Type				
facets	<table border="1"> <tr> <td>Kind</td> <td>Value</td> </tr> <tr> <td>pattern</td> <td>[01]</td> </tr> </table>	Kind	Value	pattern	[01]
Kind	Value				
pattern	[01]				

element **Scelta2PerMilleAssCult_Type/SceltaNonEffettuata**

diagram					
namespace	urn:www.agenziaentrate.gov.it:specificheTecniche:sco:sce				
type	DatoCB_Type				
facets	<table border="1"> <tr> <td>Kind</td> <td>Value</td> </tr> <tr> <td>pattern</td> <td>[01]</td> </tr> </table>	Kind	Value	pattern	[01]
Kind	Value				
pattern	[01]				

element **Scelta2PerMilleAssCult_Type/Anomalia**

diagram	
namespace	urn:www.agenziaentrate.gov.it:specificheTecniche:sco:sce

type	restriction of DatoN1_Type	
facets	Kind	Value
	pattern	[1-9]
	enumeration	1
	enumeration	2
	enumeration	3
	enumeration	4
	enumeration	5

complexType **Scelta5PerMille_Type**

diagram	
namespace	urn:www.agenziaentrate.gov.it:specificheTecniche:sco:sce
children	sce:SostegnoVolontariatoNonLucrative sce:RicercaScientifica sce:RicercaSanitaria sce:BeniCulturaliPaesaggistici sce:SostegnoSocialeComune sce:SostegnoAssociazioniSportive sce:SceltaNonEffetuata sce:Anomalia sce:FlagAnomaliaCFbeneficiario

element **Scelta5PerMille_Type/SostegnoVolontariatoNonLucrative**

diagram	
namespace	urn:www.agenziaentrate.gov.it:specificheTecniche:sco:sce
type	Firma_Type
children	Firma CodiceFiscale

element **Scelta5PerMille_Type/RicercaScientifica**

diagram	
namespace	urn:www.agenziaentrate.gov.it:specificheTecniche:sco:sce
type	Firma_Type
children	Firma CodiceFiscale

element **Scelta5PerMille_Type/RicercaSanitaria**

diagram	
namespace	urn:www.agenziaentrate.gov.it:specificheTecniche:sco:sce
type	Firma_Type
children	Firma CodiceFiscale

element **Scelta5PerMille_Type/BeniCulturaliPaesaggistici**

diagram	
namespace	urn:www.agenziaentrate.gov.it:specificheTecniche:sco:sce
children	sce:Firma

element **Scelta5PerMille_Type/BeniCulturaliPaesaggistici/Firma**

diagram					
namespace	urn:www.agenziaentrate.gov.it:specificheTecniche:sco:sce				
type	DatoCB_Type				
facets	<table border="1"> <thead> <tr> <th>Kind</th> <th>Value</th> </tr> </thead> <tbody> <tr> <td>pattern</td> <td>[01]</td> </tr> </tbody> </table>	Kind	Value	pattern	[01]
Kind	Value				
pattern	[01]				

element **Scelta5PerMille_Type/SostegnoSocialeComune**

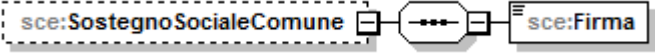
diagram	
namespace	urn:www.agenziaentrate.gov.it:specificheTecniche:sco:sce
children	sce:Firma

element **Scelta5PerMille_Type/SostegnoSocialeComune/Firma**

diagram	
namespace	urn:www.agenziaentrate.gov.it:specificheTecniche:sco:sce
type	DatoCB_Type
facets	Kind Value pattern [01]

element **Scelta5PerMille_Type/SostegnoAssociazioniSportive**

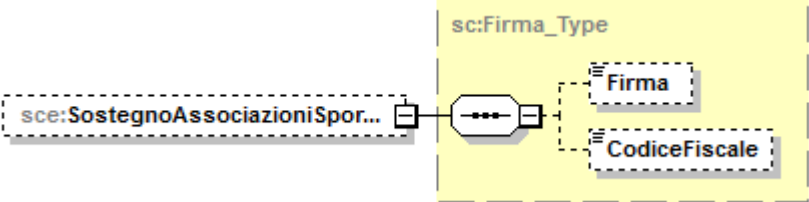
diagram	
namespace	urn:www.agenziaentrate.gov.it:specificheTecniche:sco:sce
type	Firma_Type
children	Firma CodiceFiscale

element **Scelta5PerMille_Type/SceltaNonEffettuata**

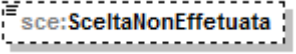
diagram	
namespace	urn:www.agenziaentrate.gov.it:specificheTecniche:sco:sce
type	DatoCB_Type
facets	Kind Value pattern [01]

element **Scelta5PerMille_Type/Anomalia**

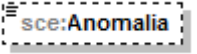
diagram	
namespace	urn:www.agenziaentrate.gov.it:specificheTecniche:sco:sce
type	restriction of DatoN1_Type

facets	Kind	Value
	pattern	[1-9]
	enumeration	1
	enumeration	2
	enumeration	3
	enumeration	4
enumeration	5	

element **Scelta5PerMille_Type/FlagAnomaliaCFbeneficiario**

diagram	
namespace	urn:www.agenziaentrate.gov.it:specificheTecniche:sco:sce
type	DatoCB_Type
facets	Kind Value pattern [01]

complexType **Scelta8PerMille_Type**

diagram	
namespace	urn:www.agenziaentrate.gov.it:specificheTecniche:sco:sce
children	sce:Stato sce:ChiesaCattolica sce:UnioneChieseCristianeAvventiste7giorno sce:AssembleeDiDioInItalia sce:UnioneDelleChieseMetodisteValdesi sce:ChiesaEvangelicaLuteranaInItalia

	sce:UnioneComunitaEbraicheItaliane sce:SacraArcidiocesiOrtodossaEsarcato sce:ChiesaApostolicaItalia sce:UnioneCristianaEvangelicaBattista sce:UnioneBuddhistaItaliana sce:UnioneInduistaItaliana sce:SceltaNonEffettuata sce:Anomalia
--	---

element **Scelta8PerMille_Type/Stato**

diagram	
namespace	urn:www.agenziaentrate.gov.it:specificheTecniche:sco:sce
type	DatoCB_Type
facets	Kind Value pattern [01]

element **Scelta8PerMille_Type/ChiesaCattolica**

diagram	
namespace	urn:www.agenziaentrate.gov.it:specificheTecniche:sco:sce
type	DatoCB_Type
facets	Kind Value pattern [01]

element **Scelta8PerMille_Type/UnioneChieseCristianeAvventiste7giorno**

diagram	
namespace	urn:www.agenziaentrate.gov.it:specificheTecniche:sco:sce
type	DatoCB_Type
facets	Kind Value pattern [01]

element **Scelta8PerMille_Type/AssembleeDiDioliInItalia**

diagram	
namespace	urn:www.agenziaentrate.gov.it:specificheTecniche:sco:sce
type	DatoCB_Type
facets	Kind Value pattern [01]

element **Scelta8PerMille_Type/UnioneDelleChieseMetodisteValdesi**

diagram	
namespace	urn:www.agenziaentrate.gov.it:specificheTecniche:sco:sce

type	DatoCB_Type
facets	Kind Value pattern [01]

element **Scelta8PerMille_Type/ChiesaEvangelicaLuteranaInItalia**

diagram	
namespace	urn:www.agenziaentrate.gov.it:specificheTecniche:sco:sce
type	DatoCB_Type
facets	Kind Value pattern [01]

element **Scelta8PerMille_Type/UnioneComunitaEbraicheItaliane**

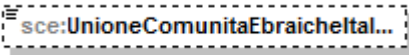
diagram	
namespace	urn:www.agenziaentrate.gov.it:specificheTecniche:sco:sce
type	DatoCB_Type
facets	Kind Value pattern [01]

element **Scelta8PerMille_Type/SacraArcidiocesiOrtodossaEsarcato**

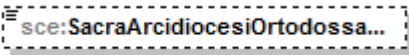
diagram	
namespace	urn:www.agenziaentrate.gov.it:specificheTecniche:sco:sce
type	DatoCB_Type
facets	Kind Value pattern [01]

element **Scelta8PerMille_Type/ChiesaApostolicaItalia**

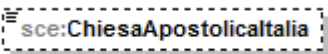
diagram	
namespace	urn:www.agenziaentrate.gov.it:specificheTecniche:sco:sce
type	DatoCB_Type
facets	Kind Value pattern [01]

element **Scelta8PerMille_Type/UnioneCristianaEvangelicaBattista**

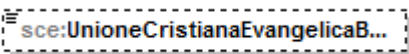
diagram	
---------	---

namespace	urn:www.agenziaentrate.gov.it:specificheTecniche:sco:sce
type	DatoCB_Type
facets	Kind Value pattern [01]

element **Scelta8PerMille_Type/UnioneBuddhistaltaliana**

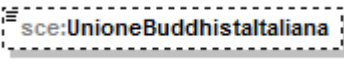
diagram	 The diagram shows a dashed rectangular box containing the text 'sce:UnioneBuddhistaltaliana'. To the left of the box is a small icon consisting of three horizontal lines of decreasing length, resembling a list or menu icon.
namespace	urn:www.agenziaentrate.gov.it:specificheTecniche:sco:sce
type	DatoCB_Type
facets	Kind Value pattern [01]

element **Scelta8PerMille_Type/UnioneInduistaltaliana**

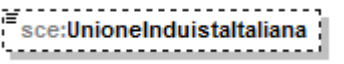
diagram	 The diagram shows a dashed rectangular box containing the text 'sce:UnioneInduistaltaliana'. To the left of the box is a small icon consisting of three horizontal lines of decreasing length, resembling a list or menu icon.
namespace	urn:www.agenziaentrate.gov.it:specificheTecniche:sco:sce
type	DatoCB_Type
facets	Kind Value pattern [01]

element **Scelta8PerMille_Type/SceltaNonEffettuata**

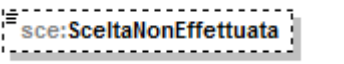
diagram	 The diagram shows a dashed rectangular box containing the text 'sce:SceltaNonEffettuata'. To the left of the box is a small icon consisting of three horizontal lines of decreasing length, resembling a list or menu icon.
namespace	urn:www.agenziaentrate.gov.it:specificheTecniche:sco:sce
type	DatoCB_Type
facets	Kind Value pattern [01]

element **Scelta8PerMille_Type/Anomalia**

diagram	 The diagram shows a dashed rectangular box containing the text 'sce:Anomalia'. To the left of the box is a small icon consisting of three horizontal lines of decreasing length, resembling a list or menu icon.
namespace	urn:www.agenziaentrate.gov.it:specificheTecniche:sco:sce
type	restriction of DatoN1_Type
facets	Kind Value pattern [1-9] enumeration 1 enumeration 2 enumeration 3

complexType **Scelte_Type**

diagram	
namespace	urn:www.agenziaentrate.gov.it:specificheTecniche:sco:sce
children	sce:Scelta5PerMille sce:Scelta8PerMille sce:Scelta2PerMille sce:Scelta2PerMilleAssCult

element **Scelte_Type/Scelta5PerMille**

diagram	
namespace	urn:www.agenziaentrate.gov.it:specificheTecniche:sco:sce
type	sce:Scelta5PerMille_Type
children	sce:SostegnoVolontariatoNonLucrative sce:RicercaScientifica sce:RicercaSanitaria sce:BeniCulturaliPaesaggistici sce:SostegnoSocialeComune sce:SostegnoAssociazioniSportive sce:SceltaNonEffettuata sce:Anomalia sce:FlagAnomaliaCFbeneficiario

element **Scelte_Type/Scelta8PerMille**

<p>diagram</p>	
<p>namespace</p>	<p>urn:www.agenziaentrate.gov.it:specificheTecniche:sco:sce</p>
<p>type</p>	<p>sce:Scelta8PerMille_Type</p>
<p>children</p>	<p>sce:Stato sce:ChiesaCattolica sce:UnioneChieseCristianeAvventiste7giorno sce:AssembleeDiDioInItalia sce:UnioneDelleChieseMetodisteValdesi sce:ChiesaEvangelicaLuteranaInItalia sce:UnioneComunitaEbraicheitaliane sce:SacraArcidiocesiOrtodossaEsarcato sce:ChiesaApostolicaItalia sce:UnioneCristianaEvangelicaBattista sce:UnioneBuddhistaitaliana sce:UnioneInduistaitaliana sce:SceltaNonEffettuata sce:Anomalia</p>

element **Scelte_Type/Scelta2PerMille**

diagram	
namespace	urn:www.agenziaentrate.gov.it:specificheTecniche:sco:sce
type	sce:Scelta2PerMille_Type
children	sce:Codice sce:Firma sce:SceltaNonEffettuata sce:Anomalia

element **Scelte_Type/Scelta2PerMilleAssCult**

diagram	
namespace	urn:www.agenziaentrate.gov.it:specificheTecniche:sco:sce
type	sce:Scelta2PerMilleAssCult_Type
children	sce:CodiceFiscale sce:Firma sce:SceltaNonEffettuata sce:Anomalia

simpleType **DatoAN_Type**

namespace	urn:www.agenziaentrate.gov.it:specificheTecniche:common				
type	restriction of xs:string				
facets	<table border="1"> <tr> <td>Kind</td> <td>Value</td> </tr> <tr> <td>pattern</td> <td>([0-9A-Z-])&quot;}{1}([0-9A-Z&amp;:] ' - \., / ° '\'\'\'(\)\ À È É Ì Ò Ù Ü &quot; \\ / +)*</td> </tr> </table>	Kind	Value	pattern	([0-9A-Z-])"}{1}([0-9A-Z&:] ' - \., / ° '\'\'\'(\)\ À È É Ì Ò Ù Ü " \\ / +)*
Kind	Value				
pattern	([0-9A-Z-])"}{1}([0-9A-Z&:] ' - \., / ° '\'\'\'(\)\ À È É Ì Ò Ù Ü " \\ / +)*				

simpleType **DatoCB12_Type**

namespace	urn:www.agenziaentrate.gov.it:specificheTecniche:common				
type	restriction of xs:byte				
facets	<table border="1"> <tr> <td>Kind</td> <td>Value</td> </tr> <tr> <td>pattern</td> <td>[10]{12}</td> </tr> </table>	Kind	Value	pattern	[10]{12}
Kind	Value				
pattern	[10]{12}				

simpleType DatoCB_Type

namespace	urn:www.agenziaentrate.gov.it:specificheTecniche:common				
type	restriction of xs:byte				
facets	<table border="1"><tr><td>Kind</td><td>Value</td></tr><tr><td>pattern</td><td>[01]</td></tr></table>	Kind	Value	pattern	[01]
Kind	Value				
pattern	[01]				

simpleType DatoCF_Type

namespace	urn:www.agenziaentrate.gov.it:specificheTecniche:common				
type	restriction of xs:string				
facets	<table border="1"><tr><td>Kind</td><td>Value</td></tr><tr><td>pattern</td><td>[0-9]{11}[A-Z]{6}[0-9LMNPQRSTU]{2}[A-Z]{1}[0-9LMNPQRSTU]{2}[A-Z]{1}[0-9LMNPQRSTU]{3}[A-Z]{1}</td></tr></table>	Kind	Value	pattern	[0-9]{11}[A-Z]{6}[0-9LMNPQRSTU]{2}[A-Z]{1}[0-9LMNPQRSTU]{2}[A-Z]{1}[0-9LMNPQRSTU]{3}[A-Z]{1}
Kind	Value				
pattern	[0-9]{11}[A-Z]{6}[0-9LMNPQRSTU]{2}[A-Z]{1}[0-9LMNPQRSTU]{2}[A-Z]{1}[0-9LMNPQRSTU]{3}[A-Z]{1}				

simpleType DatoCN_Type

namespace	urn:www.agenziaentrate.gov.it:specificheTecniche:common				
type	restriction of xs:string				
facets	<table border="1"><tr><td>Kind</td><td>Value</td></tr><tr><td>pattern</td><td>[0-9]{11}</td></tr></table>	Kind	Value	pattern	[0-9]{11}
Kind	Value				
pattern	[0-9]{11}				

simpleType DatoCP_Type

namespace	urn:www.agenziaentrate.gov.it:specificheTecniche:common				
type	restriction of xs:string				
facets	<table border="1"><tr><td>Kind</td><td>Value</td></tr><tr><td>pattern</td><td>[0-9]{5}</td></tr></table>	Kind	Value	pattern	[0-9]{5}
Kind	Value				
pattern	[0-9]{5}				

simpleType DatoD6_Type

namespace	urn:www.agenziaentrate.gov.it:specificheTecniche:common				
type	restriction of xs:string				
facets	<table border="1"><tr><td>Kind</td><td>Value</td></tr><tr><td>pattern</td><td>((0[0-9])(1[0-2]))((19 20)[0-9][0-9])</td></tr></table>	Kind	Value	pattern	((0[0-9])(1[0-2]))((19 20)[0-9][0-9])
Kind	Value				
pattern	((0[0-9])(1[0-2]))((19 20)[0-9][0-9])				

simpleType DatoDA_Type

namespace	urn:www.agenziaentrate.gov.it:specificheTecniche:common				
type	restriction of xs:string				
facets	<table border="1"><tr><td>Kind</td><td>Value</td></tr><tr><td>pattern</td><td>(18 19 20)[0-9]{2}</td></tr></table>	Kind	Value	pattern	(18 19 20)[0-9]{2}
Kind	Value				
pattern	(18 19 20)[0-9]{2}				

simpleType DatoDN_Type

namespace	urn:www.agenziaentrate.gov.it:specificheTecniche:common
type	restriction of xs:string

facets	Kind pattern	Value (((0[1-9][12][0-9]3[01])(0[13578]10 12)\d{4}))(((0[1-9][12][0-9]30)(0[469]11)\d{4}))(((0[1-9]1[0-9]2[0-8])(02)\d{4}))(((29)(02)([02468][048]00))(((29)(02)([13579][26]00))(((29)(02)([0-9][0-9][0][48]))(((29)(02)([0-9][0-9][2468][048]))(((29)(02)([0-9][0-9][13579][26]))))
--------	-----------------	---

simpleType DatoDT_Type

namespace	urn:www.agenziaentrate.gov.it:specificheTecniche:common	
type	restriction of xs:string	
facets	Kind pattern	Value (((0[1-9][12][0-9]3[01])(0[13578]10 12)\d{4}))(((0[1-9][12][0-9]30)(0[469]11)\d{4}))(((0[1-9]1[0-9]2[0-8])(02)\d{4}))(((29)(02)([02468][048]00))(((29)(02)([13579][26]00))(((29)(02)([0-9][0-9][0][48]))(((29)(02)([0-9][0-9][2468][048]))(((29)(02)([0-9][0-9][13579][26]))))

simpleType DatoEM_Type

namespace	urn:www.agenziaentrate.gov.it:specificheTecniche:common	
type	restriction of xs:string	
facets	Kind pattern	Value [a-zA-Z0-9_%\-\"?^~=]+@[a-zA-Z0-9\.\-].{a-zA-Z}(2,4)

simpleType DatoGA_Type

namespace	urn:www.agenziaentrate.gov.it:specificheTecniche:common	
type	restriction of xs:string	
facets	Kind pattern	Value [1-9]([1-9][0-9]) ([12][0-9][0-9])(3[0-5][0-9])(36[0-5])

simpleType DatoN1_Type

namespace	urn:www.agenziaentrate.gov.it:specificheTecniche:common	
type	restriction of xs:string	
facets	Kind pattern	Value [1-9]

simpleType DatoNP_Type

namespace	urn:www.agenziaentrate.gov.it:specificheTecniche:common	
type	restriction of xs:string	
facets	Kind pattern	Value [1-9]{1}[0-9]*

simpleType DatoNU_Type

namespace	urn:www.agenziaentrate.gov.it:specificheTecniche:common	
type	restriction of xs:string	
facets	Kind pattern	Value (\[1-9][1-9])[0-9]*

simpleType **DatoPC_Type**

namespace	urn:www.agenziaentrate.gov.it:specificheTecniche:common				
type	restriction of xs:string				
facets	<table><tr><td>Kind</td><td>Value</td></tr><tr><td>pattern</td><td>[0-9]?[0-9](,\d{1,3})? 100,0{1,3}?</td></tr></table>	Kind	Value	pattern	[0-9]?[0-9](,\d{1,3})? 100,0{1,3}?
Kind	Value				
pattern	[0-9]?[0-9](,\d{1,3})? 100,0{1,3}?				

simpleType **DatoPI_Type**

namespace	urn:www.agenziaentrate.gov.it:specificheTecniche:common				
type	restriction of xs:string				
facets	<table><tr><td>Kind</td><td>Value</td></tr><tr><td>pattern</td><td>[0-7][0-9]{10}</td></tr></table>	Kind	Value	pattern	[0-7][0-9]{10}
Kind	Value				
pattern	[0-7][0-9]{10}				

simpleType **DatoQU_Type**

namespace	urn:www.agenziaentrate.gov.it:specificheTecniche:common				
type	restriction of xs:string				
facets	<table><tr><td>Kind</td><td>Value</td></tr><tr><td>pattern</td><td>[0-9]+,[0-9]{1,5}?</td></tr></table>	Kind	Value	pattern	[0-9]+,[0-9]{1,5}?
Kind	Value				
pattern	[0-9]+,[0-9]{1,5}?				

simpleType **DatoTL_Type**

namespace	urn:www.agenziaentrate.gov.it:specificheTecniche:common				
type	restriction of xs:string				
facets	<table><tr><td>Kind</td><td>Value</td></tr><tr><td>pattern</td><td>[0-9]*</td></tr></table>	Kind	Value	pattern	[0-9]*
Kind	Value				
pattern	[0-9]*				

simpleType **DatoVP_Type**

namespace	urn:www.agenziaentrate.gov.it:specificheTecniche:common				
type	restriction of xs:string				
facets	<table><tr><td>Kind</td><td>Value</td></tr><tr><td>pattern</td><td>[0-9]+,[0-9]{2}</td></tr></table>	Kind	Value	pattern	[0-9]+,[0-9]{2}
Kind	Value				
pattern	[0-9]+,[0-9]{2}				

simpleType **Casella_Quadro_Type**

namespace	urn:www.agenziaentrate.gov.it:specificheTecniche:sco:common												
type	restriction of DatoAN_Type												
facets	<table><tr><td>Kind</td><td>Value</td></tr><tr><td>pattern</td><td>([0-9A-Z-]&quot;){1}([0-9A-Z&amp;] \- \. , ° °\ ()À È É ì ò ù Û &quot; \ \ +)*</td></tr><tr><td>enumeration</td><td>0</td></tr><tr><td>enumeration</td><td>1</td></tr><tr><td>enumeration</td><td>2</td></tr><tr><td>enumeration</td><td>3</td></tr></table>	Kind	Value	pattern	([0-9A-Z-]"){1}([0-9A-Z&] \- \. , ° °\ ()À È É ì ò ù Û " \ \ +)*	enumeration	0	enumeration	1	enumeration	2	enumeration	3
Kind	Value												
pattern	([0-9A-Z-]"){1}([0-9A-Z&] \- \. , ° °\ ()À È É ì ò ù Û " \ \ +)*												
enumeration	0												
enumeration	1												
enumeration	2												
enumeration	3												

simpleType Codice_Carica_Type

namespace	urn:www.agenziaentrate.gov.it:specificheTecniche:sco:common	
type	restriction of DatoNP_Type	
facets	Kind	Value
	pattern	[1-9]{1}[0-9]*
	enumeration	1
	enumeration	2
	enumeration	3
	enumeration	4
	enumeration	5
	enumeration	6
	enumeration	7
	enumeration	8
	enumeration	9
	enumeration	10
	enumeration	11
	enumeration	12
	enumeration	13
	enumeration	14
	enumeration	15

simpleType Codice_Regione_Type

namespace	urn:www.agenziaentrate.gov.it:specificheTecniche:sco:common	
type	restriction of DatoAN_Type	
facets	Kind	Value
	pattern	([0-9A-Z\-\-] "){1}([0-9A-Z&] '\- \., / \°\^\ \(\) À È É ì ò Ù Ü " \ \\ \ +)*
	enumeration	1
	enumeration	2
	enumeration	3
	enumeration	4
	enumeration	5
	enumeration	6
	enumeration	7
	enumeration	8
	enumeration	9
	enumeration	10
	enumeration	11
	enumeration	12
	enumeration	13
	enumeration	14
	enumeration	15
	enumeration	16
	enumeration	17
	enumeration	18
	enumeration	19
	enumeration	20
	enumeration	21

simpleType Natura_Giuridica_Type

namespace	urn:www.agenziaentrate.gov.it:specificheTecniche:sco:common	
type	restriction of DatoNP_Type	
facets	Kind	Value
	pattern	[1-9]{1}[0-9]*
	enumeration	1
	enumeration	2
	enumeration	3
	enumeration	4
	enumeration	5

enumeration	6
enumeration	7
enumeration	8
enumeration	9
enumeration	10
enumeration	11
enumeration	12
enumeration	13
enumeration	14
enumeration	15
enumeration	16
enumeration	17
enumeration	18
enumeration	19
enumeration	20
enumeration	21
enumeration	22
enumeration	23
enumeration	24
enumeration	25
enumeration	26
enumeration	27
enumeration	28
enumeration	29
enumeration	30
enumeration	31
enumeration	32
enumeration	33
enumeration	34
enumeration	35
enumeration	36
enumeration	37
enumeration	38
enumeration	39
enumeration	40
enumeration	41
enumeration	42
enumeration	43
enumeration	44
enumeration	45
enumeration	50
enumeration	51
enumeration	52
enumeration	53
enumeration	54
enumeration	55
enumeration	56
enumeration	57
enumeration	58
enumeration	59

simpleType Sesso_Type

namespace	urn:www.agenziaentrate.gov.it:specificheTecniche:sco:common								
type	restriction of DatoAN_Type								
facets	<table border="1"> <thead> <tr> <th>Kind</th> <th>Value</th> </tr> </thead> <tbody> <tr> <td>pattern</td> <td>([0-9A-Z\-\]&quot;){1}([0-9A-Z&amp;] '\- \., / \^\(\ \)\À È É Ì Ò Ù Ü &quot; \ \ +)*</td> </tr> <tr> <td>enumeration</td> <td>M</td> </tr> <tr> <td>enumeration</td> <td>F</td> </tr> </tbody> </table>	Kind	Value	pattern	([0-9A-Z\-\]"){1}([0-9A-Z&] '\- \., / \^\(\ \)\À È É Ì Ò Ù Ü " \ \ +)*	enumeration	M	enumeration	F
Kind	Value								
pattern	([0-9A-Z\-\]"){1}([0-9A-Z&] '\- \., / \^\(\ \)\À È É Ì Ò Ù Ü " \ \ +)*								
enumeration	M								
enumeration	F								

simpleType Situazione_Type

namespace	urn:www.agenziaentrate.gov.it:specificheTecniche:sco:common
-----------	---

type	restriction of DatoNP_Type																		
facets	<table border="1"> <thead> <tr> <th>Kind</th> <th>Value</th> </tr> </thead> <tbody> <tr> <td>pattern</td> <td>[1-9]{1}[0-9]*</td> </tr> <tr> <td>enumeration</td> <td>1</td> </tr> <tr> <td>enumeration</td> <td>2</td> </tr> <tr> <td>enumeration</td> <td>3</td> </tr> <tr> <td>enumeration</td> <td>4</td> </tr> <tr> <td>enumeration</td> <td>5</td> </tr> <tr> <td>enumeration</td> <td>6</td> </tr> <tr> <td>enumeration</td> <td>7</td> </tr> </tbody> </table>	Kind	Value	pattern	[1-9]{1}[0-9]*	enumeration	1	enumeration	2	enumeration	3	enumeration	4	enumeration	5	enumeration	6	enumeration	7
Kind	Value																		
pattern	[1-9]{1}[0-9]*																		
enumeration	1																		
enumeration	2																		
enumeration	3																		
enumeration	4																		
enumeration	5																		
enumeration	6																		
enumeration	7																		

simpleType **Stato_Type**

namespace	urn:www.agenziaentrate.gov.it:specificheTecniche:sco:common												
type	restriction of DatoNP_Type												
facets	<table border="1"> <thead> <tr> <th>Kind</th> <th>Value</th> </tr> </thead> <tbody> <tr> <td>pattern</td> <td>[1-9]{1}[0-9]*</td> </tr> <tr> <td>enumeration</td> <td>1</td> </tr> <tr> <td>enumeration</td> <td>2</td> </tr> <tr> <td>enumeration</td> <td>3</td> </tr> <tr> <td>enumeration</td> <td>4</td> </tr> </tbody> </table>	Kind	Value	pattern	[1-9]{1}[0-9]*	enumeration	1	enumeration	2	enumeration	3	enumeration	4
Kind	Value												
pattern	[1-9]{1}[0-9]*												
enumeration	1												
enumeration	2												
enumeration	3												
enumeration	4												

simpleType **Eventi_Ecc_Type**

namespace	urn:www.agenziaentrate.gov.it:specificheTecniche:sco:common										
type	restriction of xs:string										
facets	<table border="1"> <thead> <tr> <th>Kind</th> <th>Value</th> </tr> </thead> <tbody> <tr> <td>enumeration</td> <td>1</td> </tr> <tr> <td>enumeration</td> <td>2</td> </tr> <tr> <td>enumeration</td> <td>3</td> </tr> <tr> <td>enumeration</td> <td>4</td> </tr> </tbody> </table>	Kind	Value	enumeration	1	enumeration	2	enumeration	3	enumeration	4
Kind	Value										
enumeration	1										
enumeration	2										
enumeration	3										
enumeration	4										

simpleType **Estero**

namespace	urn:www.agenziaentrate.gov.it:specificheTecniche:common				
type	restriction of xs:string				
facets	<table border="1"> <thead> <tr> <th>Kind</th> <th>Value</th> </tr> </thead> <tbody> <tr> <td>enumeration</td> <td>EE</td> </tr> </tbody> </table>	Kind	Value	enumeration	EE
Kind	Value				
enumeration	EE				

simpleType **PE_Type**

namespace	urn:www.agenziaentrate.gov.it:specificheTecniche:common
type	union of (ProvinciItaliane , Estero)

simpleType **PN_Type**

namespace	urn:www.agenziaentrate.gov.it:specificheTecniche:common
type	union of (ProvinciItaliane , ProvincieCroate , Estero , ProvincieSoppresse)

simpleType PR_Type

namespace	urn:www.agenziaentrate.gov.it:specificheTecniche:common
type	union of (ProvinciItaliane)

simpleType ProvincieCroate

namespace	urn:www.agenziaentrate.gov.it:specificheTecniche:common								
type	restriction of xs:string								
facets	<table border="1"> <thead> <tr> <th>Kind</th> <th>Value</th> </tr> </thead> <tbody> <tr> <td>enumeration</td> <td>FU</td> </tr> <tr> <td>enumeration</td> <td>PL</td> </tr> <tr> <td>enumeration</td> <td>ZA</td> </tr> </tbody> </table>	Kind	Value	enumeration	FU	enumeration	PL	enumeration	ZA
Kind	Value								
enumeration	FU								
enumeration	PL								
enumeration	ZA								

simpleType ProvinciItaliane

namespace	urn:www.agenziaentrate.gov.it:specificheTecniche:common																																																																																						
type	restriction of xs:string																																																																																						
facets	<table border="1"> <thead> <tr> <th>Kind</th> <th>Value</th> </tr> </thead> <tbody> <tr><td>enumeration</td><td>AG</td></tr> <tr><td>enumeration</td><td>AL</td></tr> <tr><td>enumeration</td><td>AN</td></tr> <tr><td>enumeration</td><td>AO</td></tr> <tr><td>enumeration</td><td>AP</td></tr> <tr><td>enumeration</td><td>AQ</td></tr> <tr><td>enumeration</td><td>AR</td></tr> <tr><td>enumeration</td><td>AT</td></tr> <tr><td>enumeration</td><td>AV</td></tr> <tr><td>enumeration</td><td>BA</td></tr> <tr><td>enumeration</td><td>BG</td></tr> <tr><td>enumeration</td><td>BI</td></tr> <tr><td>enumeration</td><td>BL</td></tr> <tr><td>enumeration</td><td>BN</td></tr> <tr><td>enumeration</td><td>BO</td></tr> <tr><td>enumeration</td><td>BR</td></tr> <tr><td>enumeration</td><td>BS</td></tr> <tr><td>enumeration</td><td>BT</td></tr> <tr><td>enumeration</td><td>BZ</td></tr> <tr><td>enumeration</td><td>CA</td></tr> <tr><td>enumeration</td><td>CB</td></tr> <tr><td>enumeration</td><td>CE</td></tr> <tr><td>enumeration</td><td>CH</td></tr> <tr><td>enumeration</td><td>CI</td></tr> <tr><td>enumeration</td><td>CL</td></tr> <tr><td>enumeration</td><td>CN</td></tr> <tr><td>enumeration</td><td>CO</td></tr> <tr><td>enumeration</td><td>CR</td></tr> <tr><td>enumeration</td><td>CS</td></tr> <tr><td>enumeration</td><td>CT</td></tr> <tr><td>enumeration</td><td>CZ</td></tr> <tr><td>enumeration</td><td>EN</td></tr> <tr><td>enumeration</td><td>FC</td></tr> <tr><td>enumeration</td><td>FE</td></tr> <tr><td>enumeration</td><td>FG</td></tr> <tr><td>enumeration</td><td>FI</td></tr> <tr><td>enumeration</td><td>FM</td></tr> <tr><td>enumeration</td><td>FR</td></tr> <tr><td>enumeration</td><td>GE</td></tr> <tr><td>enumeration</td><td>GO</td></tr> <tr><td>enumeration</td><td>GR</td></tr> <tr><td>enumeration</td><td>IM</td></tr> </tbody> </table>	Kind	Value	enumeration	AG	enumeration	AL	enumeration	AN	enumeration	AO	enumeration	AP	enumeration	AQ	enumeration	AR	enumeration	AT	enumeration	AV	enumeration	BA	enumeration	BG	enumeration	BI	enumeration	BL	enumeration	BN	enumeration	BO	enumeration	BR	enumeration	BS	enumeration	BT	enumeration	BZ	enumeration	CA	enumeration	CB	enumeration	CE	enumeration	CH	enumeration	CI	enumeration	CL	enumeration	CN	enumeration	CO	enumeration	CR	enumeration	CS	enumeration	CT	enumeration	CZ	enumeration	EN	enumeration	FC	enumeration	FE	enumeration	FG	enumeration	FI	enumeration	FM	enumeration	FR	enumeration	GE	enumeration	GO	enumeration	GR	enumeration	IM
Kind	Value																																																																																						
enumeration	AG																																																																																						
enumeration	AL																																																																																						
enumeration	AN																																																																																						
enumeration	AO																																																																																						
enumeration	AP																																																																																						
enumeration	AQ																																																																																						
enumeration	AR																																																																																						
enumeration	AT																																																																																						
enumeration	AV																																																																																						
enumeration	BA																																																																																						
enumeration	BG																																																																																						
enumeration	BI																																																																																						
enumeration	BL																																																																																						
enumeration	BN																																																																																						
enumeration	BO																																																																																						
enumeration	BR																																																																																						
enumeration	BS																																																																																						
enumeration	BT																																																																																						
enumeration	BZ																																																																																						
enumeration	CA																																																																																						
enumeration	CB																																																																																						
enumeration	CE																																																																																						
enumeration	CH																																																																																						
enumeration	CI																																																																																						
enumeration	CL																																																																																						
enumeration	CN																																																																																						
enumeration	CO																																																																																						
enumeration	CR																																																																																						
enumeration	CS																																																																																						
enumeration	CT																																																																																						
enumeration	CZ																																																																																						
enumeration	EN																																																																																						
enumeration	FC																																																																																						
enumeration	FE																																																																																						
enumeration	FG																																																																																						
enumeration	FI																																																																																						
enumeration	FM																																																																																						
enumeration	FR																																																																																						
enumeration	GE																																																																																						
enumeration	GO																																																																																						
enumeration	GR																																																																																						
enumeration	IM																																																																																						

enumeration	IS
enumeration	KR
enumeration	LC
enumeration	LE
enumeration	LI
enumeration	LO
enumeration	LT
enumeration	LU
enumeration	MB
enumeration	MC
enumeration	ME
enumeration	MI
enumeration	MN
enumeration	MO
enumeration	MS
enumeration	MT
enumeration	NA
enumeration	NO
enumeration	NU
enumeration	OG
enumeration	OR
enumeration	OT
enumeration	PA
enumeration	PC
enumeration	PD
enumeration	PE
enumeration	PG
enumeration	PI
enumeration	PN
enumeration	PO
enumeration	PR
enumeration	PT
enumeration	PU
enumeration	PV
enumeration	PZ
enumeration	RA
enumeration	RC
enumeration	RE
enumeration	RG
enumeration	RI
enumeration	RM
enumeration	RN
enumeration	RO
enumeration	SA
enumeration	SI
enumeration	SO
enumeration	SP
enumeration	SR
enumeration	SS
enumeration	SV
enumeration	TA
enumeration	TE
enumeration	TN
enumeration	TO
enumeration	TP
enumeration	TR
enumeration	TS
enumeration	TV
enumeration	UD
enumeration	VA
enumeration	VB
enumeration	VC
enumeration	VE
enumeration	VI
enumeration	VR
enumeration	VS
enumeration	VT
enumeration	VV

simpleType ProvincieSoppresse

namespace	urn:www.agenziaentrate.gov.it:specificheTecniche:common	
type	restriction of xs:string	
facets	Kind	Value
	enumeration	FO
	enumeration	PS

schema location: [fornitura734_2016_v1.xsd](#)
 attribute form default: **unqualified**
 element form default: **qualified**
 targetNamespace: **urn:www.agenziaentrate.gov.it:specificheTecniche:sco:730**

Elements

[Fornitura730-4](#)

element Fornitura730-4

diagram	
namespace	urn:www.agenziaentrate.gov.it:specificheTecniche:sco:730
children	m730:Intestazione m730:Documento_730-4

element Fornitura730-4/Intestazione

diagram	
namespace	urn:www.agenziaentrate.gov.it:specificheTecniche:sco:730
children	m730:CodiceFornitura m730:TipoFornitore m730:TotaleDocumenti

element Fornitura730-4/Intestazione/CodiceFornitura

diagram	
namespace	urn:www.agenziaentrate.gov.it:specificheTecniche:sco:730

type	DatoAN_Type
facets	Kind Value pattern ([0-9A-Z\-_]"){1}([0-9A-Z&:] ' \- \., / ^ \^\(\ \)\} \À É È Ì Ò Ù Û " \ \ /+)*

element Fornitura730-4/Intestazione/TipoFornitore

diagram	
namespace	urn:www.agenziaentrate.gov.it:specificheTecniche:sco:730
type	DatoNP_Type
facets	Kind Value pattern [1-9]{1}[0-9]*

element Fornitura730-4/Intestazione/TotaleDocumenti

diagram	
namespace	urn:www.agenziaentrate.gov.it:specificheTecniche:sco:730
type	DatoNP_Type
facets	Kind Value pattern [1-9]{1}[0-9]*

element Fornitura730-4/Documento_730-4

diagram	
namespace	urn:www.agenziaentrate.gov.it:specificheTecniche:sco:730
type	m730:Documento_730-4
children	m730:DatiAnagraficiDichiarante m730:Sostituto m730:SoggettoAssFiscale730-4 m730:AltriDati m730:DatiContabili730-4