

ALLEGATO A

**Specifiche tecniche per la trasmissione
telematica Modello 730/2015**

INDICE

1	AVVERTENZE GENERALI	3
2	BREVI CENNI SUL LINGUAGGIO XML.....	3
3	CONTENUTO DELLA FORNITURA	5
3.1	GENERALITÀ.....	5
3.2	COERENZA DEI DATI DELLA DICHIARAZIONE	6
3.3	IL TRATTAMENTO DEL CODICE FISCALE	6
3.4	SOGGETTO CHE PRESTA L'ASSISTENZA FISCALE	7
4	TRASMISSIONE TELEMATICA DEL MOD. 730-4 DA PARTE DEI CAF, DEL PROFESSIONISTA ABILITATO O DI UNA ASSOCIAZIONE PROFESSIONALE ALL'AGENZIA DELLE ENTRATE E DESTINATO AI SOSTITUTI D'IMPOSTA.....	8
4.1	TRASMISSIONE TELEMATICA DEL MOD. 730-4: CASI PARTICOLARI.....	8
4.2	DATI MOD. 730-4 RESI DISPONIBILI DALL'AGENZIA DELLE ENTRATE AI SOSTITUTI O INTERMEDIARI	8
5	SPECIFICHE TECNICHE IN FORMATO XML.....	9
5.1	GENERALITÀ SPECIFICHE TECNICHE IN FORMATO XML.....	9
5.1.1	<i>Messaggio</i>	9
5.1.2	<i>Intestazione</i>	9
5.1.3	<i>Contenuto</i>	9
5.1.4	<i>Fornitura</i>	10
5.1.5	<i>Intestazione</i>	10
5.1.6	<i>Documento 730</i>	11
5.2	SPECIFICHE TECNICHE IN FORMATO XML	11

CONTENUTO E CARATTERISTICHE TECNICHE DEI DATI DELLE DICHIARAZIONI DEI REDDITI MODELLO 730/2015 DA INVIARE ALL'AMMINISTRAZIONE FINANZIARIA IN VIA TELEMATICA

1 AVVERTENZE GENERALI

I Sostituti d'imposta, i Centri di Assistenza Fiscale, i professionisti abilitati, le società e gli enti di grandi dimensioni, nonché gli intermediari abilitati, trasmettono i dati delle dichiarazioni dei Mod.730, all'**Agenzia delle Entrate** in via telematica.

Il contenuto e le caratteristiche della fornitura dei dati da trasmettere all'Agenzia delle Entrate in via telematica sono riportati nelle specifiche tecniche di seguito esposte.

Si precisa che una dichiarazione da inviare, i cui dati non sono conformi alle indicazioni delle presenti specifiche tecniche, verrà scartata.

Le modalità per la trasmissione dei dati in via telematica sono stabilite con il decreto del 31 luglio 1998 (pubblicato nella G.U. del 12 agosto 1998, n. 187) e successive modificazioni.

2 Brevi cenni sul linguaggio XML

L'Agenzia delle Entrate ha scelto di adottare, per la definizione della fornitura relativa alle dichiarazioni 730 2015, il linguaggio XML (eXtensible Markup Language).

L'XML è un metalinguaggio, ossia una "grammatica", per la definizione di documenti da gestire con strumenti informatici.

Per "grammatica" si intende l'insieme standard di definizioni e di regole sintattiche mediante le quali la struttura logica di un documento viene tradotta in una corrispondente struttura fisica, composta di elementi sintattici chiamati **tag**, ossia sequenze di caratteri delimitate dai segni '<' e '>'.

Concretamente, un file XML è un file di testo costituito da diversi **elementi** individuati dai **tag**, ciascuno dei quali identifica un componente logico del documento.

Gli **elementi** sono organizzati secondo una **struttura gerarchica**: ciascun **elemento** può infatti contenere altri elementi (**sottoelementi**) oppure del testo. L'elemento principale della struttura "ad albero" così ottenuta è denominato **radice (root element)**.

Agli **elementi** possono essere associate altre informazioni che ne descrivono le proprietà, tali informazioni sono chiamate **attributi**.

La modellazione della fornitura delle dichiarazioni 730/2015 è stata realizzata introducendo la radice denominata Messaggio, all'interno della quale sono stati individuati i due sottoelementi Intestazione e Contenuto.

L'elemento Intestazione espone il codice fiscale del soggetto responsabile dell'invio telematico, l'elemento Contenuto definisce al suo interno una Fornitura astratta che, nel caso del modello 730 2015, assume le caratteristiche di quella ad esso relativa e descritta nel paragrafo 5. L'elemento Contenuto espone l'attributo codiceFornitura che per il suddetto modello deve essere impostato al valore 73015.

Nel paragrafo 5 vengono fornite ulteriori indicazioni relative agli elementi sopra citati.

La struttura della fornitura xml è descritta, mediante l'**XML Schema**, in uno specifico documento (**schema document**), identificato dall'estensione "xsd". Il file XSD (XML Schema Definition) delinea il contenuto della fornitura definendone gli elementi ed evidenziandone attributi e relazioni reciproche.

In particolare, lo **schema** relativo alla fornitura xml identifica tre diverse tipologie di componenti: elementi di significato generale, ossia indipendenti dal tipo di documento contenuto nella fornitura stessa, elementi che rappresentano i componenti logici di una generica dichiarazione ed elementi che costituiscono, più specificamente, la struttura di una dichiarazione Modello 730.

Ciascuna delle suddette tipologie di componenti individua un "dominio di nomi" (**namespace**), un ambito nel quale gli elementi sono univoci ed hanno significato omogeneo.

Concretamente, lo schema relativo alla fornitura 730 si compone di un insieme di documenti xsd, associati ai tre diversi namespace, nei quali sono definiti, oltre agli elementi della fornitura, anche i tipi di dati ad essi associati ed alcuni elenchi di codici predefiniti previsti per gli elementi della dichiarazione.

3 CONTENUTO DELLA FORNITURA

3.1 Generalità

La fornitura oggetto della trasmissione telematica deve essere conforme alle specifiche dell'eXtensible Markup Language (XML) 1.0 (raccomandazione WC3 10 febbraio 1998) e deve essere codificata secondo la codifica UTF-8.

Il contenuto della fornitura xml, relativa al Modello 730/2015, deve inoltre soddisfare la sintassi descritta nel file XSD denominato "**fornitura730_2015_v1.xsd**", allegato al presente documento.

Il suddetto schema definisce la struttura della fornitura xml, delineando gli elementi permessi, i loro attributi, i tipi di dati ad essi associati e la relazione gerarchica tra gli elementi stessi.

La procedura distribuita dall'Agenzia delle Entrate esegue una prima fase di **validazione** della fornitura, ossia di verifica che il file sia conforme allo schema ad esso associato ed una successiva fase di **controllo**, nella quale esamina la correttezza dei dati indicati applicando regole specifiche per ciascun elemento.

L'esito negativo della validazione determina lo scarto dell'intera fornitura.

I diagnostici generati in fase di **controllo** possono avere una diversa gravità a seconda dell'elemento interessato e possono determinare lo scarto della singola dichiarazione o dell'intera fornitura.

3.2 Coerenza dei dati della dichiarazione

Nella “*Circolare per la liquidazione ed il controllo del modello 730/2015*” trovano esposizione anche le regole che definiscono l'accoglimento o meno della dichiarazione 730/2015 da trasmettere in via telematica all'Agenzia delle Entrate. In particolare sono riportati, oltre a tutti i criteri per la puntuale determinazione delle imposte, anche i criteri di accoglimento della dichiarazione. Tali criteri, sono suddivisi in confermabili e bloccanti. La dichiarazione 730/2015 predisposta con le modalità previste nelle presenti specifiche tecniche XML, deve essere conforme ai criteri sopra citati. La non conformità della dichiarazione ai suddetti criteri, determina il non accoglimento della stessa in sede di trasmissione telematica.

3.3 Il trattamento del Codice Fiscale

I codici fiscali riportati nelle dichiarazioni mod. 730/2015 devono essere formalmente corretti. Si precisa che in sede di accoglimento delle dichiarazioni trasmesse in via telematica, costituirà oggetto di scarto della dichiarazione stessa l'indicazione di un **codice fiscale del contribuente** che, anche se formalmente corretto, non risulti registrato presso l'Anagrafe Tributaria.

Nel caso di omocodia del codice fiscale del contribuente risolta dall'Agenzia delle Entrate con l'attribuzione di un nuovo codice fiscale, l'indicazione in dichiarazione del precedente codice fiscale (omocodice) comporta, in sede di accoglimento delle dichiarazioni trasmesse in via telematica, lo scarto della dichiarazione.

Il codice fiscale del rappresentante deve essere registrato in Anagrafe Tributaria; la non registrazione comporta lo scarto della dichiarazione in fase di accettazione **senza possibilità di conferma della stessa.**

Il codice fiscale del sostituto d'imposta che effettuerà le operazioni di conguaglio deve essere registrato in Anagrafe Tributaria; la non registrazione comporta lo scarto della dichiarazione in fase di accettazione senza possibilità di conferma della stessa.

Da quest'anno anche ciascun codice fiscale indicato nel prospetto dei familiari a carico deve essere registrato in Anagrafe Tributaria; la non registrazione comporta lo scarto della dichiarazione in fase di accettazione senza possibilità di conferma della stessa.

3.4 Soggetto che presta l'assistenza fiscale

L'indicazione del soggetto che ha prestato l'assistenza fiscale con i relativi dati identificativi e l'indicazione della data di consegna del mod. 730/2015 sono obbligatori. Si rimanda alle istruzioni fornite nella circolare di liquidazione al paragrafo "Dati assistenza fiscale da riportare nel flusso telematico".

4 TRASMISSIONE TELEMATICA DEL MOD. 730-4 DA PARTE DEI CAF, DEL PROFESSIONISTA ABILITATO O DI UNA ASSOCIAZIONE PROFESSIONALE ALL'AGENZIA DELLE ENTRATE E DESTINATO AI SOSTITUTI D'IMPOSTA

Le modifiche normative apportate al D.M. n. 164 del 1999, prevedono che i soggetti che prestano l'assistenza fiscale trasmettano i risultati finali delle dichiarazioni relative al mod. 730 (mod. 730-4) non più direttamente ai sostituti d'imposta ma all'Agenzia delle Entrate la quale provvederà successivamente ad inviarli telematicamente al sostituto d'imposta.

Pertanto, in sede di trasmissione telematica delle dichiarazioni relative al modello 730/2015, qualora l'assistenza fiscale sia prestata da un CAF, da un professionista abilitato o da una associazione i dati relativi al suddetto mod. 730-4 dovranno essere allegati ai dati della dichiarazione mod. 730/2015 da trasmettere in via telematica.

In sede di accoglimento delle dichiarazioni trasmesse in via telematica, costituisce oggetto di controllo sia la presenza dei dati relativi al mod. 730-4 che la coerenza dei dati contenuti nel mod. 730-4 con quelli presenti nel modello 730/2015. Eventuali anomalie riscontrate determinano lo scarto della dichiarazione.

Ai sostituti d'imposta i dati relativi al mod. 730-4 saranno resi disponibili presso la sede telematica comunicata con l'apposito modello di comunicazione trasmesso all'Agenzia delle Entrate; si rimanda alle precisazioni contenute nel successivo paragrafo "Dati mod. 730-4 resi disponibili dall'Agenzia delle Entrate ai Sostituti o Intermediari".

4.1 Trasmissione telematica del mod. 730-4: Casi particolari

Nel caso in cui dalla liquidazione della dichiarazione (mod. 730 ordinario ovvero mod. 730 integrativo), risulti che non ci sia alcun importo da trattenere o da rimborsare a cura del sostituto d'imposta, i dati relativi al mod. 730-4 non devono essere riportati nel tracciato telematico della dichiarazione 730 2015 e deve essere impostato ad "1" l'apposito campo (**FlagAssenzaDati730-4**) previsto nelle presenti specifiche tecniche del modello 730/2015. La non corretta impostazione della suddetta casella determina lo scarto della dichiarazione 730/2015.

4.2 Dati mod. 730-4 resi disponibili dall'Agenzia delle Entrate ai Sostituti o Intermediari

I dati relativi al mod. 730-4 saranno resi disponibili da parte dell'Agenzia delle Entrate ai sostituti d'imposta ovvero agli intermediari da questi incaricati in conformità alle istruzioni contenute nelle presenti specifiche tecniche relative al mod. 730/2015 nella sezione riferita alla "**Fornitura 730-4**". La sintassi della fornitura relativa ai mod. 730-4 è descritta nel file XSD denominato "**fornitura734_2015_v1.xsd**" la cui documentazione è allegata al presente documento.

5 Specifiche tecniche in formato XML

5.1 Generalità Specifiche tecniche in formato XML

5.1.1 Messaggio

Lo schema prevede la definizione di un elemento principale (radice della struttura) denominato **Messaggio**. Esso è un elemento xml di tipo complesso contenente la sequenza ordinata di due sotto-elementi obbligatori **Intestazione** e **Contenuto** dei quali può essere presente una sola occorrenza.

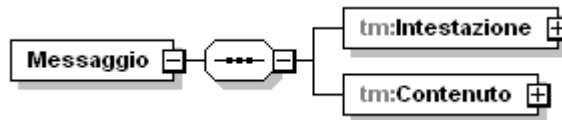

5.1.2 Intestazione

L'elemento xml denominato **Intestazione** è un elemento obbligatorio di tipo complesso **Intestazione_Type** illustrato nella figura seguente.

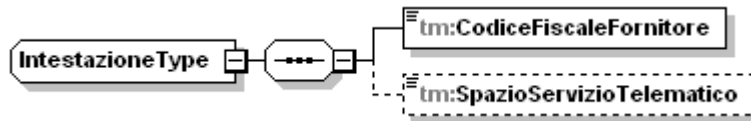

L'elemento **Intestazione** deve contenere i seguenti sottoelementi semplici rispettando la sequenza indicata:

CodiceFiscaleFornitore

È un elemento obbligatorio di tipo semplice che deve esporre il codice fiscale del soggetto responsabile della trasmissione telematica. Il dato è di tipo alfanumerico e può essere composto, in alternativa, o da 11 caratteri numerici (nel caso in cui il codice fiscale si riferisca ad una persona giuridica) oppure da 16 caratteri alfanumerici maiuscoli (nel caso in cui il codice fiscale sia relativo ad una persona fisica).

SpazioServizioTelematico

È un elemento opzionale che deve esporre alcune informazioni riservate al servizio telematico. Tale elemento, pertanto, viene creato esclusivamente da funzionalità predisposte dal servizio telematico. Il dato in esso contenuto è di tipo alfanumerico.

5.1.3 Contenuto

L'elemento xml denominato **Contenuto** deve contenere, al suo interno, i dati identificativi della fornitura ai fini della trasmissione telematica. Pertanto è un elemento di tipo complesso **Contenuto_Type** illustrato nella figura successiva.

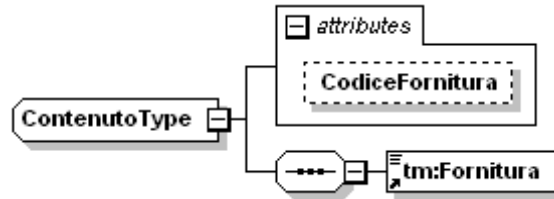

In particolare tale elemento prevede un attributo denominato **CodiceFornitura** ed un sottoelemento **Fornitura**.

L'attributo **CodiceFornitura** identifica il codice della fornitura e serve per individuare in maniera univoca la tipologia di documento contenuto nel file. Tale elemento di tipo semplice è obbligatorio e deve essere composto da 5 caratteri alfanumerici maiuscoli. Per il modello 730/2014 deve assumere il seguente valore **"73015"**.

L'elemento xml denominato **Fornitura**, invece, è un elemento obbligatorio di tipo astratto che deve essere, di volta in volta, implementato dai diversi tipi di fornitura XML.

Comunicazione dati rettificati caf o professionisti (Codice Fornitura "73C15")

L'art. 6 (visto di conformità) del decreto legislativo 21 novembre 2014, n. 175, ha apportato delle modifiche all'art. 39 del decreto legislativo 9 luglio 1997, n. 241. In particolare, se il Caf o il professionista appone un visto di conformità infedele, è tenuto al pagamento di una somma pari all'importo dell'imposta, della sanzione e degli interessi che sarebbero stati richiesti al contribuente a seguito dei controlli formali da parte dell'Agenzia delle entrate, sempre che il visto infedele non sia stato indotto dalla condotta dolosa del contribuente. Se entro il 10 novembre dell'anno in cui la violazione è stata commessa il Caf o il professionista trasmette una dichiarazione rettificativa del contribuente oppure, se il contribuente non intende presentare la nuova dichiarazione, trasmette una comunicazione dei dati relativi alla rettifica, la somma dovuta dal Caf o dal professionista è pari all'importo della sola sanzione. **La trasmissione delle informazioni relative ai dati rettificati deve avvenire mediante il medesimo flusso telematico utilizzato per la trasmissione del modello 730 2015 in conformità alle indicazioni fornite nella Circolare di liquidazione del modello 730 2015 ed impostando l'attributo CodiceFornitura al valore "73C15"**.

5.1.4 Fornitura

L'elemento denominato **Fornitura** ed è un elemento xml complesso contenente la sequenza ordinata di due sottoelementi: **Intestazione** e **Documento730**, del quale possono essere presenti una o più occorrenze.

5.1.5 Intestazione

L'elemento Intestazione contiene i dati del soggetto responsabile dell'invio telematico (fornitore):

- TipoFornitore - è l'elemento che definisce la tipologia del soggetto che esegue la trasmissione, è di tipo DatoNP_Type.

- SpazioUtente - è un elemento opzionale il cui contenuto può essere liberamente definito dall'utente ed è di tipo DatoAN_Type

5.1.6 Documento 730

L'elemento Documento 730 è di tipo Documento_730_Type. Il tipo Documento_730_Type definisce l'attributo obbligatorio denominato **identificativo**. Tale attributo ha lo scopo di identificare univocamente il generico documento nell'ambito della fornitura ed è di tipo DatoNP_Type.

Controlli previsti per l'attributo:



Validazione: la lunghezza massima prevista è di 5 caratteri.

Controllo bloccante: il valore assunto dall'attributo deve essere univoco all'interno dell'intera fornitura.

5.2 Specifiche tecniche in formato XML

Di seguito viene descritto il contenuto informativo dei dati della fornitura da trasmettere in via telematica (**fornitura730_2015_v1.xsd e fornitura734_2015_v1.xsd**).

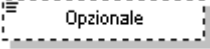
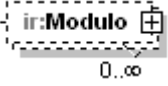
Per la rappresentazione grafica della struttura gerarchica sono utilizzati alcuni simboli grafici descritti nella seguente tabella:

	<p>Elemento obbligatorio</p>
	<p>Elemento opzionale</p>
	<p>Elemento ripetuto 0 o più volte</p>
	<p>Sequenza ordinata di elementi (Sequence)</p>
	<p>Alternativa tra due o più elementi (Choice)</p>

Schema **fornitura730_2015_v1.xsd**

schema location: **fornitura730_2015_v1.xsd**
attribute form default: **unqualified**
element form default: **qualified**
targetNamespace: **urn:www.agenziaentrate.gov.it:specificheTecniche:sco:730**

Elements

[Fornitura](#)

schema location: **documento730_2015_v1.xsd**
attribute form default: **unqualified**
element form default: **qualified**
targetNamespace: **urn:www.agenziaentrate.gov.it:specificheTecniche:sco:730**

Complex types

[Accounti Altri Dati Type](#)
[Accounti Irpef Anno Imposta Type](#)
[Accounti Ritenute Type](#)
[Acquisto Costruzione Abit Locazione](#)
[Addizionali Type](#)
[Altre Detrazioni Type](#)
[Altre Ritenute Type](#)
[Altre Spese Type](#)
[Altri Dati Type](#)
[Altri Oneri Type](#)
[Altri Redditi Ass Lavd Type](#)
[Altri Redditi Diversi Detr Type](#)
[Altri Redditi Diversi Type](#)
[Altri Redditi Lavoro Autonomo Type](#)
[Altri Redditi Type](#)
[Altri Redditi Utili Type](#)
[Annotazione Type](#)
[Assegno Coniuge Type](#)
[Bonus Irpef Type](#)
[Casella Acconto Type](#)
[Cedolare Secca Type](#)
[Conguaglio Type](#)
[Contributi Previdenza Complementare Type](#)
[Contributo Solidarieta Type](#)
[Cred Imp Estero Type](#)
[Crediti F24 Type](#)
[Crediti Imposta](#)
[Crediti Imposta Altri Sisma Abruzzo Type](#)
[Crediti Imposta Fabbicati Type](#)
[Crediti Imposta Fondi Pensione Type](#)
[Crediti Imposta Redditi Esteri Type](#)
[Credito Immobile Sisma Abruzzo Type](#)
[Credito Stato Type](#)
[Credito Type](#)
[Dati 730Integrativo Type](#)
[Dati Altre Detrazioni Modulo Type](#)
[Dati Altre Detrazioni Type](#)
[Dati Associazioni Professionale Type](#)
[Dati CAF Type](#)
[Dati Catastali Recupero Patrimonio Edilizio Type](#)
[Dati Coniuge Type](#)
[Dati Contabili Type](#)
[Dati Contratto Type](#)
[Dati Familiare Type](#)
[Dati Nascita PF Type](#)
[Dati Primo Figlio Type](#)
[Dati Professionista Type](#)

[Dati Registrazione Accatastamento Recupero Patrimonio Edilizio Type](#)

[Dati Rettificati Type](#)

[Debito Type](#)

[Deduzioni Modulo Type](#)

[Deduzioni Type](#)

[Detrazione Crediti Type](#)

[Detrazioni Canoni Locazione Type](#)

[Detrazioni Modulo Type](#)

[Detrazioni Type](#)

[Dich Non Precompilata](#)

[Dich Precompilata Type](#)

[Dichiarazione Con Type](#)

[Dichiarazione Dich Type](#)

[Documento 730-4](#)

[Documento 730 Type](#)

[Domicilio Fiscale type](#)

[Domicilio Sogg Ass Fiscale Type](#)

[Eccedenze Type](#)

[Elemento Integrativo Type](#)

[Esenzione Add Comunale Type](#)

[Esito Liquidazione Type](#)

[FabbricatoAgev Type](#)

[FabbricatoOrd Type](#)

[Familiari PrimoModulo Type](#)

[Familiari Type](#)

[Firma Dichiarazione Type](#)

[Fondo Pensione Dipendenti Pubblici Type](#)

[Frontespizio 730 Type](#)

[Frontespizio Con Type](#)

[Frontespizio Dich Type](#)

[Fuori Assistenza Type](#)

[Giorni Percentuale Type](#)

[Importi Rimborsare730-4 Type](#)

[Importi Rimborsare 730-4 Integrativo Type](#)

[ImportiTrattenere730-4](#)

[Importo 730-4](#)

[Imposta Lorda Type](#)

[Imposta Netta Type](#)

[Imposte Rimborsate Type](#)

[Incremento Produttivita Type](#)

[Inquilini Abitazione Principale Type](#)

[Intervento Recupero Patrimonio Edilizio Type](#)

[Intervento Risparmio Energetico Type](#)

[Lavoro Dipendente Type](#)

[Misura Acconti Type](#)

[Mod730 Integrativo Type](#)

[Modulo Altri Redditi Type](#)

[Modulo Annotazioni Type](#)

[Modulo Crediti Imposta Type](#)

[Modulo Fabbricato Type](#)

[Modulo Familiari Type](#)

[Modulo Lavoro Dip Type](#)

[Modulo Oneri Type](#)

[Modulo PL Type](#)

[Modulo Terreno Type](#)

[N Rate Type](#)

[Oneri Non Abbattuti Type](#)

[Oneri Type](#)

[Opzione Produttivita Type](#)

[Periodo Di Lavoro Type](#)

[Primo Modulo Acconti Ritenute Type](#)

[Primo Modulo Crediti Imposta Type](#)

[Primo Modulo Lavoro Dip Type](#)

[Primo Modulo PL Type](#)

[PrimoModulo Oneri Type](#)

[Prospetto Annotazioni Type](#)

[Prospetto Liquidazione Type](#)

[Prospetto Type](#)

[Quadro I Type](#)

[Redditi Capitale Type](#)

[Redditi Eredi Legatari Type](#)
[Redditi Fabbricati Type](#)
[Redditi Lavoro Dip Type](#)
[Redditi Ritenute Spese Type](#)
[Redditi Ritenute Type](#)
[Redditi Tassazione Separata Type](#)
[Redditi Terreni Type](#)
[Reddito Erede Type](#)
[Residenza Anagrafica 730 Type](#)
[Residenza Rappresentante Type](#)
[Residenza Type](#)
[Residuo Credito Compens Annolmposta Type](#)
[Residuo Credito Compens Type](#)
 [Rettifica Type](#)
[Riepilogo Redditi Type](#)
[Ritenute Acconti Sospesi Type](#)
[Ritenute Lavoro Dip Type](#)
[Sezione Altri Redd Type](#)
[Sezione Dati Catastali Recupero Patrimonio Edilizio Type](#)
[Soggetto Assistenza FiscaliDoc type](#)
[Soggetto Fiscale 730 Type](#)
[Soglie Esenzione Type](#)
[Sostituto Type](#)
[Spese Arredo Type](#)
[Spese Rateizzate Anni Precedenti Type](#)
[Spese Rateizzate Type](#)
[Tassazione Separata Type](#)
[Terreno Type](#)
[Versamenti F24 Type](#)

schema location: **intestazione730_2015_v1.xsd**
attribute form default: **unqualified**
element form default: **qualified**
targetNamespace: **urn:www.agenziaentrate.gov.it:specificheTecniche:sco:730**

Complex types

[Intestazione 730 Type](#)

schema location: **documentoSce_2015_v1.xsd**
attribute form default: **unqualified**
element form default: **qualified**
targetNamespace: **urn:www.agenziaentrate.gov.it:specificheTecniche:sco:sce**

Complex types

[Dichiarazione SCE Type](#)
[Documento SCE Type](#)
[Frontespizio SCE Type](#)
[Scelta2PerMille Type](#)
[Scelta5PerMille Type](#)
[Scelta8PerMille Type](#)
[Scelte Type](#)

schema location: **datiSce_2015_v1.xsd**
attribute form default: **unqualified**
element form default: **qualified**
targetNamespace: **urn:www.agenziaentrate.gov.it:specificheTecniche:sco:sce**

Complex types

[DatiAnagraficiScelte_Type](#)
[Documento_Type](#)

element **Fornitura**

diagram	
namespace	urn:www.agenziaentrate.gov.it:specificheTecniche:sco:730
children	m730:Intestazione m730:Documento730
source	<pre><xs:element name="Fornitura" substitutionGroup="tm:Fornitura"> <xs:complexType> <xs:sequence> <xs:element name="Intestazione" type="m730:Intestazione_730_Type"/> <xs:element name="Documento730" type="m730:Documento_730_Type" maxOccurs="unbounded"/> </xs:sequence> </xs:complexType> </xs:element></pre>

element **Fornitura/Intestazione**

diagram	
namespace	urn:www.agenziaentrate.gov.it:specificheTecniche:sco:730
type	m730:Intestazione_730_Type
children	m730:TipoFornitore m730:SpazioUtente
source	<pre><xs:element name="Intestazione" type="m730:Intestazione_730_Type"/></pre>

element **Fornitura/Documento730**

<p>diagram</p>											
<p>namespace</p>	<p>urn:www.agenziaentrate.gov.it:specificheTecniche:sco:730</p>										
<p>type</p>	<p>m730:Documento_730_Type</p>										
<p>children</p>	<p>m730:DichiarazioneDich m730:DichiarazioneCon m730:AltriDati m730:DichPrecompilata m730:DichNonPrecompilata m730:Sostituto m730:Mod730DipendentiSenzaSostituto m730:SoggettoAssFiscaleDoc m730:Documento_730-4 m730:EsitiContabili m730:DatiRettificati</p>										
<p>attributes</p>	<table border="1"> <thead> <tr> <th>Name</th> <th>Type</th> <th>Use</th> <th>Default</th> <th>Fixed</th> </tr> </thead> <tbody> <tr> <td>identificativo</td> <td>Identificativo_Type</td> <td>required</td> <td></td> <td></td> </tr> </tbody> </table>	Name	Type	Use	Default	Fixed	identificativo	Identificativo_Type	required		
Name	Type	Use	Default	Fixed							
identificativo	Identificativo_Type	required									
<p>source</p>	<p><xs:element name="Documento730" type="m730:Documento_730_Type" maxOccurs="unbounded"/></p>										

complexType **Acconti_Altri_Dati_Type**

<p>diagram</p>	
----------------	--

namespace	urn:www.agenziaentrate.gov.it:specificheTecniche:sco:730
children	m730:IncapientiDetrazioneFigli m730:IncapientiDetrazioneLocazione m730:RestituzioneBonusFiscale m730:RestituzioneBonusStraordinario m730:Pignoramento
source	<pre> <xs:complexType name="Acconti_Altri_Dati_Type"> <xs:sequence> <xs:element name="IncapientiDetrazioneFigli" type="cm:DatoNP_Type" minOccurs="0"/> <xs:element name="IncapientiDetrazioneLocazione" type="cm:DatoNP_Type" minOccurs="0"/> <xs:element name="RestituzioneBonusFiscale" type="cm:DatoNP_Type" minOccurs="0"/> <xs:element name="RestituzioneBonusStraordinario" type="cm:DatoNP_Type" minOccurs="0"/> <xs:element name="Pignoramento" minOccurs="0"> <xs:complexType> <xs:sequence> <xs:element name="TipoRedditoPignoramento"> <xs:simpleType> <xs:restriction base="cm:DatoN1_Type"> <xs:enumeration value="1"/> <xs:enumeration value="2"/> <xs:enumeration value="3"/> <xs:enumeration value="4"/> <xs:enumeration value="5"/> <xs:enumeration value="6"/> </xs:restriction> </xs:simpleType> </xs:element> <xs:element name="RitenutePignoramento" type="cm:DatoNP_Type"/> </xs:sequence> </xs:complexType> </xs:element> </xs:sequence> </xs:complexType> </pre>

element **Acconti_Altri_Dati_Type/IncapientiDetrazioneFigli**

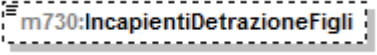
diagram					
namespace	urn:www.agenziaentrate.gov.it:specificheTecniche:sco:730				
type	DatoNP_Type				
facets	<table border="1"> <thead> <tr> <th>Kind</th> <th>Value</th> </tr> </thead> <tbody> <tr> <td>pattern</td> <td>[1-9]{1}[0-9]*</td> </tr> </tbody> </table>	Kind	Value	pattern	[1-9]{1}[0-9]*
Kind	Value				
pattern	[1-9]{1}[0-9]*				
source	<pre><xs:element name="IncapientiDetrazioneFigli" type="cm:DatoNP_Type" minOccurs="0"/></pre>				

element **Acconti_Altri_Dati_Type/IncapientiDetrazioneLocazione**

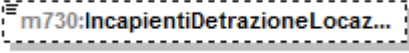
diagram					
namespace	urn:www.agenziaentrate.gov.it:specificheTecniche:sco:730				
type	DatoNP_Type				
facets	<table border="1"> <thead> <tr> <th>Kind</th> <th>Value</th> </tr> </thead> <tbody> <tr> <td>pattern</td> <td>[1-9]{1}[0-9]*</td> </tr> </tbody> </table>	Kind	Value	pattern	[1-9]{1}[0-9]*
Kind	Value				
pattern	[1-9]{1}[0-9]*				
source	<pre><xs:element name="IncapientiDetrazioneLocazione" type="cm:DatoNP_Type" minOccurs="0"/></pre>				

element **Acconti_Altri_Dati_Type/RestituzioneBonusFiscale**

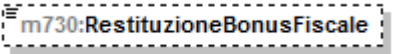
diagram	
namespace	urn:www.agenziaentrate.gov.it:specificheTecniche:sco:730

type	DatoNP_Type
facets	Kind Value pattern [1-9]{1}[0-9]*
source	<code><xs:element name="RestituzioneBonusFiscale" type="cm:DatoNP_Type" minOccurs="0"/></code>

element **Acconti_Altri_Dati_Type/RestituzioneBonusStraordinario**

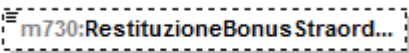
diagram	
namespace	urn:www.agenziaentrate.gov.it:specificheTecniche:sco:730
type	DatoNP_Type
facets	Kind Value pattern [1-9]{1}[0-9]*
source	<code><xs:element name="RestituzioneBonusStraordinario" type="cm:DatoNP_Type" minOccurs="0"/></code>

element **Acconti_Altri_Dati_Type/Pignoramento**

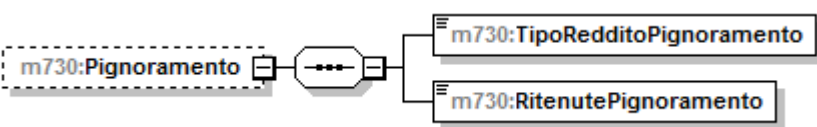
diagram	
namespace	urn:www.agenziaentrate.gov.it:specificheTecniche:sco:730
children	m730:TipoRedditoPignoramento m730:RitenutePignoramento
source	<pre><xs:element name="Pignoramento" minOccurs="0"> <xs:complexType> <xs:sequence> <xs:element name="TipoRedditoPignoramento"> <xs:simpleType> <xs:restriction base="cm:DatoN1_Type"> <xs:enumeration value="1"/> <xs:enumeration value="2"/> <xs:enumeration value="3"/> <xs:enumeration value="4"/> <xs:enumeration value="5"/> <xs:enumeration value="6"/> </xs:restriction> </xs:simpleType> </xs:element> <xs:element name="RitenutePignoramento" type="cm:DatoNP_Type"/> </xs:sequence> </xs:complexType> </xs:element></pre>

element **Acconti_Altri_Dati_Type/Pignoramento/TipoRedditoPignoramento**

diagram	
namespace	urn:www.agenziaentrate.gov.it:specificheTecniche:sco:730
type	restriction of DatoN1_Type
facets	Kind Value pattern [1-9] enumeration 1 enumeration 2 enumeration 3 enumeration 4

	enumeration 5 enumeration 6
source	<pre><xs:element name="TipoRedditoPignoramento"> <xs:simpleType> <xs:restriction base="cm:DatoN1_Type"> <xs:enumeration value="1"/> <xs:enumeration value="2"/> <xs:enumeration value="3"/> <xs:enumeration value="4"/> <xs:enumeration value="5"/> <xs:enumeration value="6"/> </xs:restriction> </xs:simpleType> </xs:element></pre>

element **Acconti_Altri_Dati_Type/Pignoramento/RitenutePignoramento**

diagram					
namespace	urn:www.agenziaentrate.gov.it:specificheTecniche:sco:730				
type	DatoNP_Type				
facets	<table border="1"> <thead> <tr> <th>Kind</th> <th>Value</th> </tr> </thead> <tbody> <tr> <td>pattern</td> <td>[1-9]{1}[0-9]*</td> </tr> </tbody> </table>	Kind	Value	pattern	[1-9]{1}[0-9]*
Kind	Value				
pattern	[1-9]{1}[0-9]*				
source	<pre><xs:element name="RitenutePignoramento" type="cm:DatoNP_Type"/></pre>				

complexType **Acconti_Irpef_Anno_Imposta_Type**

diagram	
namespace	urn:www.agenziaentrate.gov.it:specificheTecniche:sco:730
children	m730:PrimaRataAccontolrpef m730:SecondaRataAccontolrpef m730:AccontoAddComunale m730:AccontoAddComunaleF24 m730:PrimaRataAccontoCedolare m730:SecondaRataAccontoCedolare
source	<pre><xs:complexType name="Acconti_Irpef_Anno_Imposta_Type"> <xs:sequence> <xs:element name="PrimaRataAccontolrpef" type="cm:DatoNP_Type" minOccurs="0"/> <xs:element name="SecondaRataAccontolrpef" type="cm:DatoNP_Type" minOccurs="0"/> <xs:element name="AccontoAddComunale" type="cm:DatoNP_Type" minOccurs="0"/> <xs:element name="AccontoAddComunaleF24" type="cm:DatoNP_Type" minOccurs="0"/> <xs:element name="PrimaRataAccontoCedolare" type="cm:DatoNP_Type" minOccurs="0"/> <xs:element name="SecondaRataAccontoCedolare" type="cm:DatoNP_Type" minOccurs="0"/> </xs:sequence> </xs:complexType></pre>

element **Acconti_Irpef_Anno_Imposta_Type/PrimaRataAccontolrpef**

diagram	
namespace	urn:www.agenziaentrate.gov.it:specificheTecniche:sco:730
type	DatoNP_Type
facets	Kind Value pattern [1-9]{1}[0-9]*
source	<xs:element name="PrimaRataAccontolrpef" type="cm:DatoNP_Type" minOccurs="0"/>

element **Acconti_Irpef_Anno_Imposta_Type/SecondaRataAccontolrpef**

diagram	
namespace	urn:www.agenziaentrate.gov.it:specificheTecniche:sco:730
type	DatoNP_Type
facets	Kind Value pattern [1-9]{1}[0-9]*
source	<xs:element name="SecondaRataAccontolrpef" type="cm:DatoNP_Type" minOccurs="0"/>

element **Acconti_Irpef_Anno_Imposta_Type/AccontoAddComunale**

diagram	
namespace	urn:www.agenziaentrate.gov.it:specificheTecniche:sco:730
type	DatoNP_Type
facets	Kind Value pattern [1-9]{1}[0-9]*
source	<xs:element name="AccontoAddComunale" type="cm:DatoNP_Type" minOccurs="0"/>

element **Acconti_Irpef_Anno_Imposta_Type/AccontoAddComunaleF24**

diagram	
namespace	urn:www.agenziaentrate.gov.it:specificheTecniche:sco:730
type	DatoNP_Type
facets	Kind Value pattern [1-9]{1}[0-9]*
source	<xs:element name="AccontoAddComunaleF24" type="cm:DatoNP_Type" minOccurs="0"/>

element **Acconti_Irpef_Anno_Imposta_Type/PrimaRataAccontoCedolare**

diagram	
namespace	urn:www.agenziaentrate.gov.it:specificheTecniche:sco:730
type	DatoNP_Type
facets	Kind Value pattern [1-9]{1}[0-9]*
source	<xs:element name="PrimaRataAccontoCedolare" type="cm:DatoNP_Type" minOccurs="0"/>

element **Acconti_Irpef_Anno_Imposta_Type/SecondaRataAccontoCedolare**

diagram	
namespace	urn:www.agenziaentrate.gov.it:specificheTecniche:sco:730
type	DatoNP_Type
facets	Kind Value pattern [1-9]{1}[0-9]*
source	<code><xs:element name="SecondaRataAccontoCedolare" type="cm:DatoNP_Type" minOccurs="0"/></code>

complexType **Acconti_Ritenute_Type**

diagram	
namespace	urn:www.agenziaentrate.gov.it:specificheTecniche:sco:730
children	m730:PrimoModulo m730:Modulo
source	<pre><xs:complexType name="Acconti_Ritenute_Type"> <xs:annotation> <xs:documentation>Quadro F - Acconti Ritenute Eccedenze e Altri Dati</xs:documentation> </xs:annotation> <xs:sequence> <xs:element name="PrimoModulo" type="m730:Primo_Modulo_Acconti_Ritenute_Type"/> <xs:element name="Modulo" minOccurs="0" maxOccurs="unbounded"> <xs:complexType> <xs:sequence> <xs:element name="Pignoramento" minOccurs="0"> <xs:complexType> <xs:sequence> <xs:element name="TipoRedditoPignoramento"> <xs:simpleType> <xs:restriction base="cm:DatoN1_Type"> <xs:enumeration value="1"/> <xs:enumeration value="2"/> <xs:enumeration value="3"/> <xs:enumeration value="4"/> <xs:enumeration value="5"/> <xs:enumeration value="6"/> </xs:restriction> </xs:simpleType> </xs:element> <xs:element name="RitenutePignoramento" type="cm:DatoNP_Type"/> </xs:sequence> </xs:complexType> </xs:element> </xs:sequence> </xs:complexType> </xs:element> </xs:sequence> </xs:complexType></pre>

element **Acconti_Ritenute_Type/PrimoModulo**

diagram	
namespace	urn:www.agenziaentrate.gov.it:specificheTecniche:sco:730
type	m730:Primo_Modulo_Acconti_Ritenute_Type
children	m730:Accontilrpef m730:AltreRitenute m730:Eccedenze m730:RitenuteAccontiSospesi m730:MisuraAcconti m730:EsenzioneAddComunale m730:Dati730Integrativo m730:AccontiAltriDati
source	<code><xs:element name="PrimoModulo" type="m730:Primo_Modulo_Acconti_Ritenute_Type"/></code>

element **Acconti_Ritenute_Type/Modulo**

diagram	
namespace	urn:www.agenziaentrate.gov.it:specificheTecniche:sco:730
children	m730:Pignoramento
source	<pre> <xs:element name="Modulo" minOccurs="0" maxOccurs="unbounded"> <xs:complexType> <xs:sequence> <xs:element name="Pignoramento" minOccurs="0"> <xs:complexType> <xs:sequence> <xs:element name="TipoRedditoPignoramento"> <xs:simpleType> <xs:restriction base="cm:DatoN1_Type"> <xs:enumeration value="1"/> <xs:enumeration value="2"/> <xs:enumeration value="3"/> <xs:enumeration value="4"/> <xs:enumeration value="5"/> <xs:enumeration value="6"/> </xs:restriction> </xs:simpleType> </xs:element> <xs:element name="RitenutePignoramento" type="cm:DatoNP_Type"/> </xs:sequence> </xs:complexType> </xs:element> </xs:sequence> </xs:complexType> </xs:element> </pre>

	<pre> </xs:sequence> </xs:complexType> </xs:element> </pre>
--	---

element **Acconti_Ritenute_Type/Modulo/Pignoramento**

diagram	
namespace	urn:www.agenziaentrate.gov.it:specificheTecniche:sco:730
children	m730:TipoRedditoPignoramento m730:RitenutePignoramento
source	<pre> <xs:element name="Pignoramento" minOccurs="0"> <xs:complexType> <xs:sequence> <xs:element name="TipoRedditoPignoramento"> <xs:simpleType> <xs:restriction base="cm:DatoN1_Type"> <xs:enumeration value="1"/> <xs:enumeration value="2"/> <xs:enumeration value="3"/> <xs:enumeration value="4"/> <xs:enumeration value="5"/> <xs:enumeration value="6"/> </xs:restriction> </xs:simpleType> </xs:element> <xs:element name="RitenutePignoramento" type="cm:DatoNP_Type"/> </xs:sequence> </xs:complexType> </xs:element> </pre>

element **Acconti_Ritenute_Type/Modulo/Pignoramento/TipoRedditoPignoramento**

diagram																	
namespace	urn:www.agenziaentrate.gov.it:specificheTecniche:sco:730																
type	restriction of DatoN1_Type																
facets	<table border="1"> <thead> <tr> <th>Kind</th> <th>Value</th> </tr> </thead> <tbody> <tr> <td>pattern</td> <td>[1-9]</td> </tr> <tr> <td>enumeration</td> <td>1</td> </tr> <tr> <td>enumeration</td> <td>2</td> </tr> <tr> <td>enumeration</td> <td>3</td> </tr> <tr> <td>enumeration</td> <td>4</td> </tr> <tr> <td>enumeration</td> <td>5</td> </tr> <tr> <td>enumeration</td> <td>6</td> </tr> </tbody> </table>	Kind	Value	pattern	[1-9]	enumeration	1	enumeration	2	enumeration	3	enumeration	4	enumeration	5	enumeration	6
Kind	Value																
pattern	[1-9]																
enumeration	1																
enumeration	2																
enumeration	3																
enumeration	4																
enumeration	5																
enumeration	6																
source	<pre> <xs:element name="TipoRedditoPignoramento"> <xs:simpleType> <xs:restriction base="cm:DatoN1_Type"> <xs:enumeration value="1"/> <xs:enumeration value="2"/> <xs:enumeration value="3"/> <xs:enumeration value="4"/> <xs:enumeration value="5"/> <xs:enumeration value="6"/> </xs:restriction> </xs:simpleType> </xs:element> </pre>																

element **Acconti_Ritenute_Type/Modulo/Pignoramento/RitenutePignoramento**

diagram	
namespace	urn:www.agenziaentrate.gov.it:specificheTecniche:sco:730
type	DatoNP_Type
facets	Kind Value pattern [1-9]{1}[0-9]*
source	<xs:element name="RitenutePignoramento" type="cm:DatoNP_Type"/>

complexType **Acquisto_Costruzione_Abit_Locazione**

diagram	
namespace	urn:www.agenziaentrate.gov.it:specificheTecniche:sco:730
children	m730:DataStipula m730:Spesa m730:InteressiMutuo
source	<xs:complexType name="Acquisto_Costruzione_Abit_Locazione"> <xs:sequence> <xs:element name="DataStipula" type="cm:DatoDT_Type" minOccurs="0"/> <xs:element name="Spesa" type="cm:DatoNP_Type" minOccurs="0"/> <xs:element name="InteressiMutuo" type="cm:DatoNP_Type" minOccurs="0"/> </xs:sequence> </xs:complexType>

element **Acquisto_Costruzione_Abit_Locazione/DataStipula**

diagram	
namespace	urn:www.agenziaentrate.gov.it:specificheTecniche:sco:730
type	DatoDT_Type
facets	Kind Value pattern ((([0-9]{12}[0-9]{3}[01])(0[13578][10]12\d{4})) ([0-9]{12}[0-9]{30}(0[469][11]\d{4})) ([0-9]{12}[0-9]{2}[0-8])(02\d{4})) ((29)(02)[02468][048]00)) ((29)(02)[13579][26]00)) ((29)(02)[0-9][0][48]) ((29)(02)[0-9][0-9][2468][048]) ((29)(02)[0-9][0-9][13579][26]))
source	<xs:element name="DataStipula" type="cm:DatoDT_Type" minOccurs="0"/>

element **Acquisto_Costruzione_Abit_Locazione/Spesa**

diagram	
namespace	urn:www.agenziaentrate.gov.it:specificheTecniche:sco:730
type	DatoNP_Type
facets	Kind Value pattern [1-9]{1}[0-9]*
source	<xs:element name="Spesa" type="cm:DatoNP_Type" minOccurs="0"/>

element **Acquisto_Costruzione_Abit_Locazione/InteressiMutuo**

diagram	
namespace	urn:www.agenziaentrate.gov.it:specificheTecniche:sco:730
type	DatoNP_Type
facets	Kind Value pattern [1-9]{1}[0-9]*
source	<xs:element name="InteressiMutuo" type="cm:DatoNP_Type" minOccurs="0"/>

complexType **Addizionali_Type**

diagram	
namespace	urn:www.agenziaentrate.gov.it:specificheTecniche:sco:730
children	m730:Imponibile m730:AddRegDovuta m730:AddRegCertif m730:EccedenzaAddReg m730:AddComDovuta m730:AddComCertif m730:EccedenzaAddCom m730:AccontoAddCom m730:AccontoAddComCertif
source	<pre> <xs:complexType name="Addizionali_Type"> <xs:sequence> <xs:element name="Imponibile" type="cm:DatoNP_Type" minOccurs="0"/> <xs:element name="AddRegDovuta" type="cm:DatoNP_Type" minOccurs="0"/> <xs:element name="AddRegCertif" type="cm:DatoNP_Type" minOccurs="0"/> <xs:element name="EccedenzaAddReg" type="cm:DatoNU_Type" minOccurs="0"/> <xs:element name="AddComDovuta" type="cm:DatoNP_Type" minOccurs="0"/> <xs:element name="AddComCertif" type="cm:DatoNP_Type" minOccurs="0"/> <xs:element name="EccedenzaAddCom" type="cm:DatoNU_Type" minOccurs="0"/> <xs:element name="AccontoAddCom" type="cm:DatoNP_Type" minOccurs="0"/> <xs:element name="AccontoAddComCertif" type="cm:DatoNP_Type" minOccurs="0"/> </xs:sequence> </xs:complexType> </pre>

element **Addizionali_Type/Imponibile**

diagram	
namespace	urn:www.agenziaentrate.gov.it:specificheTecniche:sco:730
type	DatoNP_Type

facets	Kind Value pattern [1-9]{1}[0-9]*
source	<xs:element name="Imponibile" type="cm:DatoNP_Type" minOccurs="0"/>

element **Addizionali_Type/AddRegDovuta**

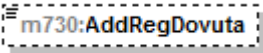
diagram	
namespace	urn:www.agenziaentrate.gov.it:specificheTecniche:sco:730
type	DatoNP_Type
facets	Kind Value pattern [1-9]{1}[0-9]*
source	<xs:element name="AddRegDovuta" type="cm:DatoNP_Type" minOccurs="0"/>

element **Addizionali_Type/AddRegCertif**

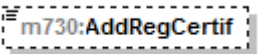
diagram	
namespace	urn:www.agenziaentrate.gov.it:specificheTecniche:sco:730
type	DatoNP_Type
facets	Kind Value pattern [1-9]{1}[0-9]*
source	<xs:element name="AddRegCertif" type="cm:DatoNP_Type" minOccurs="0"/>

element **Addizionali_Type/EccedenzaAddReg**

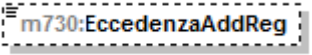
diagram	
namespace	urn:www.agenziaentrate.gov.it:specificheTecniche:sco:730
type	DatoNU_Type
facets	Kind Value pattern (\-[1-9] [1-9])[0-9]*
source	<xs:element name="EccedenzaAddReg" type="cm:DatoNU_Type" minOccurs="0"/>

element **Addizionali_Type/AddComDovuta**

diagram	
namespace	urn:www.agenziaentrate.gov.it:specificheTecniche:sco:730
type	DatoNP_Type
facets	Kind Value pattern [1-9]{1}[0-9]*
source	<xs:element name="AddComDovuta" type="cm:DatoNP_Type" minOccurs="0"/>

element **Addizionali_Type/AddComCertif**

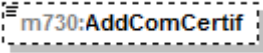
diagram	
namespace	urn:www.agenziaentrate.gov.it:specificheTecniche:sco:730

type	DatoNP_Type
facets	Kind Value pattern [1-9]{1}[0-9]*
source	<code><xs:element name="AddComCertif" type="cm:DatoNP_Type" minOccurs="0"/></code>

element **Additionali_Type/EccedenzaAddCom**

diagram	
namespace	urn:www.agenziaentrate.gov.it:specificheTecniche:sco:730
type	DatoNU_Type
facets	Kind Value pattern (\-[1-9] [1-9])[0-9]*
source	<code><xs:element name="EccedenzaAddCom" type="cm:DatoNU_Type" minOccurs="0"/></code>

element **Additionali_Type/AccountoAddCom**

diagram	
namespace	urn:www.agenziaentrate.gov.it:specificheTecniche:sco:730
type	DatoNP_Type
facets	Kind Value pattern [1-9]{1}[0-9]*
source	<code><xs:element name="AccountoAddCom" type="cm:DatoNP_Type" minOccurs="0"/></code>

element **Additionali_Type/AccountoAddComCertif**

diagram	
namespace	urn:www.agenziaentrate.gov.it:specificheTecniche:sco:730
type	DatoNP_Type
facets	Kind Value pattern [1-9]{1}[0-9]*
source	<code><xs:element name="AccountoAddComCertif" type="cm:DatoNP_Type" minOccurs="0"/></code>

complexType **Altre_Detrazioni_Type**

diagram	
namespace	urn:www.agenziaentrate.gov.it:specificheTecniche:sco:730
children	m730:Codice m730:Importo
source	<code><xs:complexType name="Altre_Detrazioni_Type"> <xs:sequence> <xs:element name="Codice" type="m730:Codice_Altre_Detrazioni_Type"/> <xs:element name="Importo" type="cm:DatoNP_Type"/> </xs:sequence> </xs:complexType></code>

element **Altre_Detrazioni_Type/Codice**

diagram									
namespace	urn:www.agenziaentrate.gov.it:specificheTecniche:sco:730								
type	m730:Codice_Altre_Detrazioni_Type								
facets	<table border="1"> <thead> <tr> <th>Kind</th> <th>Value</th> </tr> </thead> <tbody> <tr> <td>pattern</td> <td>[1-9]{1}[0-9]*</td> </tr> <tr> <td>enumeration</td> <td>1</td> </tr> <tr> <td>enumeration</td> <td>2</td> </tr> </tbody> </table>	Kind	Value	pattern	[1-9]{1}[0-9]*	enumeration	1	enumeration	2
Kind	Value								
pattern	[1-9]{1}[0-9]*								
enumeration	1								
enumeration	2								
source	<xs:element name="Codice" type="m730:Codice_Altre_Detrazioni_Type"/>								

element **Altre_Detrazioni_Type/Importo**

diagram					
namespace	urn:www.agenziaentrate.gov.it:specificheTecniche:sco:730				
type	DatoNP_Type				
facets	<table border="1"> <thead> <tr> <th>Kind</th> <th>Value</th> </tr> </thead> <tbody> <tr> <td>pattern</td> <td>[1-9]{1}[0-9]*</td> </tr> </tbody> </table>	Kind	Value	pattern	[1-9]{1}[0-9]*
Kind	Value				
pattern	[1-9]{1}[0-9]*				
source	<xs:element name="Importo" type="cm:DatoNP_Type"/>				

complexType **Altre_Ritenute_Type**

diagram	
namespace	urn:www.agenziaentrate.gov.it:specificheTecniche:sco:730
children	m730:AltreRitenuteIrpef m730:AddizionaleRegionale m730:AddizionaleComunale m730:AddRegionaleIrpefAttivitaSport m730:AddComunaleIrpefAttivitaSport m730:IrpefLavoriSocialmenteUtili m730:AddRegionaleIrpefLavoriSoc Utili
source	<pre> <xs:complexType name="Altre_Ritenute_Type"> <xs:sequence> <xs:element name="AltreRitenuteIrpef" type="cm:DatoNP_Type" minOccurs="0"/> <xs:element name="AddizionaleRegionale" type="cm:DatoNP_Type" minOccurs="0"/> <xs:element name="AddizionaleComunale" type="cm:DatoNP_Type" minOccurs="0"/> <xs:element name="AddRegionaleIrpefAttivitaSport" type="cm:DatoNP_Type" minOccurs="0"/> <xs:element name="AddComunaleIrpefAttivitaSport" type="cm:DatoNP_Type" minOccurs="0"/> <xs:element name="IrpefLavoriSocialmenteUtili" type="cm:DatoNP_Type" minOccurs="0"/> <xs:element name="AddRegionaleIrpefLavoriSoc_Utili" type="cm:DatoNP_Type" minOccurs="0"/> </xs:sequence> </xs:complexType> </pre>

element **Altre_Ritenute_Type/AltreRitenutelrpef**

diagram	
namespace	urn:www.agenziaentrate.gov.it:specificheTecniche:sco:730
type	DatoNP_Type
facets	Kind Value pattern [1-9]{1}[0-9]*
source	<xs:element name="AltreRitenutelrpef" type="cm:DatoNP_Type" minOccurs="0"/>

element **Altre_Ritenute_Type/AddizionaleRegionale**

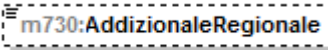
diagram	
namespace	urn:www.agenziaentrate.gov.it:specificheTecniche:sco:730
type	DatoNP_Type
facets	Kind Value pattern [1-9]{1}[0-9]*
source	<xs:element name="AddizionaleRegionale" type="cm:DatoNP_Type" minOccurs="0"/>

element **Altre_Ritenute_Type/AddizionaleComunale**

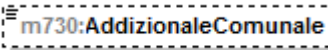
diagram	
namespace	urn:www.agenziaentrate.gov.it:specificheTecniche:sco:730
type	DatoNP_Type
facets	Kind Value pattern [1-9]{1}[0-9]*
source	<xs:element name="AddizionaleComunale" type="cm:DatoNP_Type" minOccurs="0"/>

element **Altre_Ritenute_Type/AddRegionalelrpefAttivitaSport**

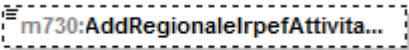
diagram	
namespace	urn:www.agenziaentrate.gov.it:specificheTecniche:sco:730
type	DatoNP_Type
facets	Kind Value pattern [1-9]{1}[0-9]*
source	<xs:element name="AddRegionalelrpefAttivitaSport" type="cm:DatoNP_Type" minOccurs="0"/>

element **Altre_Ritenute_Type/AddComunalelrpefAttivitaSport**

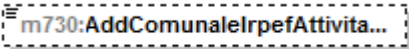
diagram	
namespace	urn:www.agenziaentrate.gov.it:specificheTecniche:sco:730
type	DatoNP_Type
facets	Kind Value pattern [1-9]{1}[0-9]*

source	<xs:element name="AddComunaleIrpefAttivitaSport" type="cm:DatoNP_Type" minOccurs="0"/>
--------	--

element **Altre_Ritenute_Type/IrpefLavoriSocialmenteUtili**

diagram					
namespace	urn:www.agenziaentrategov.it:specificheTecniche:sco:730				
type	DatoNP_Type				
facets	<table border="1"> <thead> <tr> <th>Kind</th> <th>Value</th> </tr> </thead> <tbody> <tr> <td>pattern</td> <td>[1-9]{1}[0-9]*</td> </tr> </tbody> </table>	Kind	Value	pattern	[1-9]{1}[0-9]*
Kind	Value				
pattern	[1-9]{1}[0-9]*				
source	<xs:element name="IrpefLavoriSocialmenteUtili" type="cm:DatoNP_Type" minOccurs="0"/>				

element **Altre_Ritenute_Type/AddRegionaleIrpefLavoriSoc_Utili**

diagram					
namespace	urn:www.agenziaentrategov.it:specificheTecniche:sco:730				
type	DatoNP_Type				
facets	<table border="1"> <thead> <tr> <th>Kind</th> <th>Value</th> </tr> </thead> <tbody> <tr> <td>pattern</td> <td>[1-9]{1}[0-9]*</td> </tr> </tbody> </table>	Kind	Value	pattern	[1-9]{1}[0-9]*
Kind	Value				
pattern	[1-9]{1}[0-9]*				
source	<xs:element name="AddRegionaleIrpefLavoriSoc_Utili" type="cm:DatoNP_Type" minOccurs="0"/>				

complexType **Altre_Spese_Type**

diagram	
namespace	urn:www.agenziaentrategov.it:specificheTecniche:sco:730
children	m730:Codice m730:Importo
source	<pre><xs:complexType name="Altre_Spese_Type"> <xs:sequence> <xs:element name="Codice" type="m730:Codice_Altre_Spese_Type"/> <xs:element name="Importo" type="cm:DatoNP_Type"/> </xs:sequence> </xs:complexType></pre>

element **Altre_Spese_Type/Codice**

diagram																	
namespace	urn:www.agenziaentrategov.it:specificheTecniche:sco:730																
type	m730:Codice Altre_Spese_Type																
facets	<table border="1"> <thead> <tr> <th>Kind</th> <th>Value</th> </tr> </thead> <tbody> <tr> <td>pattern</td> <td>[1-9]{1}[0-9]*</td> </tr> <tr> <td>enumeration</td> <td>8</td> </tr> <tr> <td>enumeration</td> <td>9</td> </tr> <tr> <td>enumeration</td> <td>10</td> </tr> <tr> <td>enumeration</td> <td>11</td> </tr> <tr> <td>enumeration</td> <td>13</td> </tr> <tr> <td>enumeration</td> <td>14</td> </tr> </tbody> </table>	Kind	Value	pattern	[1-9]{1}[0-9]*	enumeration	8	enumeration	9	enumeration	10	enumeration	11	enumeration	13	enumeration	14
Kind	Value																
pattern	[1-9]{1}[0-9]*																
enumeration	8																
enumeration	9																
enumeration	10																
enumeration	11																
enumeration	13																
enumeration	14																

	enumeration 15 enumeration 16 enumeration 17 enumeration 18 enumeration 20 enumeration 21 enumeration 22 enumeration 23 enumeration 24 enumeration 25 enumeration 26 enumeration 27 enumeration 28 enumeration 29 enumeration 30 enumeration 31 enumeration 32 enumeration 33 enumeration 35 enumeration 36 enumeration 37 enumeration 41 enumeration 42 enumeration 99
source	<xs:element name="Codice" type="m730:Codice_Altre_Spese_Type"/>

element **Altre_Spese_Type/Importo**

diagram	
namespace	urn:www.agenziaentrate.gov.it:specificheTecniche:sco:730
type	DatoNP_Type
facets	Kind Value pattern [1-9]{1}[0-9]*
source	<xs:element name="Importo" type="cm:DatoNP_Type"/>

complexType Altri_Dati_Type

<p>diagram</p>	
<p>namespace</p>	<p>urn:www.agenziaentrate.gov.it:specificheTecniche:sco:730</p>
<p>children</p>	<p>m730:ResiduoCreditoErogazioneCultura m730:ResiduoCreditoPrimaCasa m730:ResiduoCreditoOccupazione m730:ResiduoCreditoSisma m730:ResiduoCreditoFondiPensione m730:ResiduoCreditoMediazioni m730:TotSpeseSanitarieRateizzate m730:RedditoAgevolazioniFiscali m730:RedditoComplessivoAcconto m730:RigoDifferenzaAcconto m730:RedditiFondiariniNonImponibili m730:RedditoAbitazionePrincipalePertinenze m730:ResiduoDeduzioneSommeRestituite</p>
<p>source</p>	<pre><xs:complexType name="Altri_Dati_Type"> <xs:sequence> <xs:element name="ResiduoCreditoErogazioneCultura" type="cm:DatoNP_Type" minOccurs="0"/> <xs:element name="ResiduoCreditoPrimaCasa" type="cm:DatoNP_Type" minOccurs="0"/> <xs:element name="ResiduoCreditoOccupazione" type="cm:DatoNP_Type" minOccurs="0"/> <xs:element name="ResiduoCreditoSisma" type="cm:DatoNP_Type" minOccurs="0"/> <xs:element name="ResiduoCreditoFondiPensione" type="cm:DatoNP_Type" minOccurs="0"/> <xs:element name="ResiduoCreditoMediazioni" type="cm:DatoNP_Type" minOccurs="0"/> <xs:element name="TotSpeseSanitarieRateizzate" type="cm:DatoNP_Type" minOccurs="0"/> <xs:element name="RedditoAgevolazioniFiscali" type="cm:DatoNP_Type" minOccurs="0"/> <xs:element name="RedditoComplessivoAcconto" type="cm:DatoNP_Type" minOccurs="0"/> <xs:element name="RigoDifferenzaAcconto" type="cm:DatoNU_Type" minOccurs="0"/> <xs:element name="RedditiFondiariniNonImponibili" type="cm:DatoNP_Type" minOccurs="0"/> <xs:element name="RedditoAbitazionePrincipalePertinenze" type="cm:DatoNP_Type" minOccurs="0"/> <xs:element name="ResiduoDeduzioneSommeRestituite" type="cm:DatoNP_Type" minOccurs="0"/> </xs:sequence> </xs:complexType></pre>

element Altri_Dati_Type/ResiduoCreditoErogazioneCultura

<p>diagram</p>	
----------------	--

namespace	urn:www.agenziaentrate.gov.it:specificheTecniche:sco:730
type	DatoNP_Type
facets	Kind Value pattern [1-9]{1}[0-9]*
source	<xs:element name="ResiduoCreditoErogazioneCultura" type="cm:DatoNP_Type" minOccurs="0"/>

element Altri_Dati_Type/ResiduoCreditoPrimaCasa

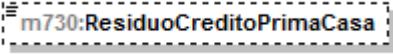
diagram	
namespace	urn:www.agenziaentrate.gov.it:specificheTecniche:sco:730
type	DatoNP_Type
facets	Kind Value pattern [1-9]{1}[0-9]*
source	<xs:element name="ResiduoCreditoPrimaCasa" type="cm:DatoNP_Type" minOccurs="0"/>

element Altri_Dati_Type/ResiduoCreditoOccupazione

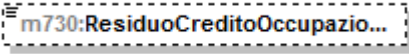
diagram	
namespace	urn:www.agenziaentrate.gov.it:specificheTecniche:sco:730
type	DatoNP_Type
facets	Kind Value pattern [1-9]{1}[0-9]*
source	<xs:element name="ResiduoCreditoOccupazione" type="cm:DatoNP_Type" minOccurs="0"/>

element Altri_Dati_Type/ResiduoCreditoSisma

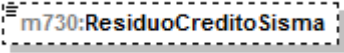
diagram	
namespace	urn:www.agenziaentrate.gov.it:specificheTecniche:sco:730
type	DatoNP_Type
facets	Kind Value pattern [1-9]{1}[0-9]*
source	<xs:element name="ResiduoCreditoSisma" type="cm:DatoNP_Type" minOccurs="0"/>

element Altri_Dati_Type/ResiduoCreditoFondiPensione

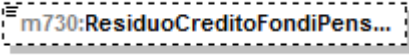
diagram	
namespace	urn:www.agenziaentrate.gov.it:specificheTecniche:sco:730
type	DatoNP_Type
facets	Kind Value pattern [1-9]{1}[0-9]*
source	<xs:element name="ResiduoCreditoFondiPensione" type="cm:DatoNP_Type" minOccurs="0"/>

element **Altri_Dati_Type/ResiduoCreditoMediazioni**

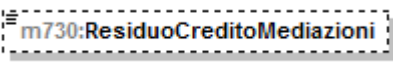
diagram	
namespace	urn:www.agenziaentrate.gov.it:specificheTecniche:sco:730
type	DatoNP_Type
facets	Kind Value pattern [1-9]{1}[0-9]*
source	<xs:element name="ResiduoCreditoMediazioni" type="cm:DatoNP_Type" minOccurs="0"/>

element **Altri_Dati_Type/TotSpeseSanitarieRateizzate**

diagram	
namespace	urn:www.agenziaentrate.gov.it:specificheTecniche:sco:730
type	DatoNP_Type
facets	Kind Value pattern [1-9]{1}[0-9]*
source	<xs:element name="TotSpeseSanitarieRateizzate" type="cm:DatoNP_Type" minOccurs="0"/>

element **Altri_Dati_Type/RedditoAgevolazioniFiscali**

diagram	
namespace	urn:www.agenziaentrate.gov.it:specificheTecniche:sco:730
type	DatoNP_Type
facets	Kind Value pattern [1-9]{1}[0-9]*
source	<xs:element name="RedditoAgevolazioniFiscali" type="cm:DatoNP_Type" minOccurs="0"/>

element **Altri_Dati_Type/RedditoComplessivoAcconto**

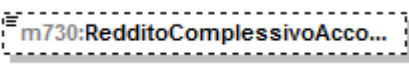
diagram	
namespace	urn:www.agenziaentrate.gov.it:specificheTecniche:sco:730
type	DatoNP_Type
facets	Kind Value pattern [1-9]{1}[0-9]*
source	<xs:element name="RedditoComplessivoAcconto" type="cm:DatoNP_Type" minOccurs="0"/>

element **Altri_Dati_Type/RigoDifferenzaAcconto**

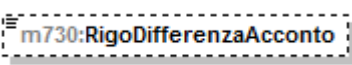
diagram	
namespace	urn:www.agenziaentrate.gov.it:specificheTecniche:sco:730
type	DatoNU_Type
facets	Kind Value pattern (\-[1-9] [1-9])[0-9]*
source	<xs:element name="RigoDifferenzaAcconto" type="cm:DatoNU_Type" minOccurs="0"/>

element Altri_Dati_Type/RedditiFondariNonImponibili

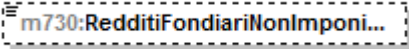
diagram	
namespace	urn:www.agenziaentrate.gov.it:specificheTecniche:sco:730
type	DatoNP_Type
facets	Kind Value pattern [1-9]{1}[0-9]*
source	<code><xs:element name="RedditiFondariNonImponibili" type="cm:DatoNP_Type" minOccurs="0"/></code>

element Altri_Dati_Type/RedditoAbitazionePrincipalePertinenze

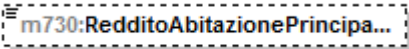
diagram	
namespace	urn:www.agenziaentrate.gov.it:specificheTecniche:sco:730
type	DatoNP_Type
facets	Kind Value pattern [1-9]{1}[0-9]*
source	<code><xs:element name="RedditoAbitazionePrincipalePertinenze" type="cm:DatoNP_Type" minOccurs="0"/></code>

element Altri_Dati_Type/ResiduoDeduzioneSommeRestituite

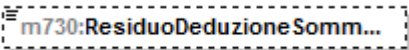
diagram	
namespace	urn:www.agenziaentrate.gov.it:specificheTecniche:sco:730
type	DatoNP_Type
facets	Kind Value pattern [1-9]{1}[0-9]*
source	<code><xs:element name="ResiduoDeduzioneSommeRestituite" type="cm:DatoNP_Type" minOccurs="0"/></code>

complexType Altri_Oneri_Type

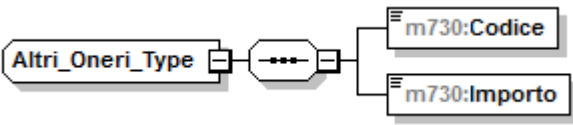
diagram	
namespace	urn:www.agenziaentrate.gov.it:specificheTecniche:sco:730
children	m730:Codice m730:Importo
source	<code><xs:complexType name="Altri_Oneri_Type"> <xs:sequence> <xs:element name="Codice" type="m730:Codice_Altri_Oneri_Type"/> <xs:element name="Importo" type="cm:DatoNP_Type"/> </xs:sequence> </xs:complexType></code>

element Altri_Oneri_Type/Codice

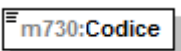
diagram	
---------	---

namespace	urn:www.agenziaentrate.gov.it:specificheTecniche:sco:730																
type	m730:Codice_Altri_Oneri_Type																
facets	<table border="0"> <tr> <td>Kind</td> <td>Value</td> </tr> <tr> <td>pattern</td> <td>[1-9]{1}[0-9]*</td> </tr> <tr> <td>enumeration</td> <td>1</td> </tr> <tr> <td>enumeration</td> <td>2</td> </tr> <tr> <td>enumeration</td> <td>3</td> </tr> <tr> <td>enumeration</td> <td>4</td> </tr> <tr> <td>enumeration</td> <td>5</td> </tr> <tr> <td>enumeration</td> <td>6</td> </tr> </table>	Kind	Value	pattern	[1-9]{1}[0-9]*	enumeration	1	enumeration	2	enumeration	3	enumeration	4	enumeration	5	enumeration	6
Kind	Value																
pattern	[1-9]{1}[0-9]*																
enumeration	1																
enumeration	2																
enumeration	3																
enumeration	4																
enumeration	5																
enumeration	6																
source	<xs:element name="Codice" type="m730:Codice_Altri_Oneri_Type"/>																

element Altri_Oneri_Type/Importo

diagram					
namespace	urn:www.agenziaentrate.gov.it:specificheTecniche:sco:730				
type	DatoNP_Type				
facets	<table border="0"> <tr> <td>Kind</td> <td>Value</td> </tr> <tr> <td>pattern</td> <td>[1-9]{1}[0-9]*</td> </tr> </table>	Kind	Value	pattern	[1-9]{1}[0-9]*
Kind	Value				
pattern	[1-9]{1}[0-9]*				
source	<xs:element name="Importo" type="cm:DatoNP_Type"/>				

complexType Altri_Redditi_Ass_Lavd_Type

diagram	
namespace	urn:www.agenziaentrate.gov.it:specificheTecniche:sco:730
children	m730:AssegnoDelConiuge m730:ImportoRedditoAssimilato
source	<pre><xs:complexType name="Altri_Redditi_Ass_Lavd_Type"> <xs:sequence> <xs:element name="AssegnoDelConiuge" type="cm:DatoCB_Type" minOccurs="0"/> <xs:element name="ImportoRedditoAssimilato" type="cm:DatoNP_Type" minOccurs="0"/> </xs:sequence> </xs:complexType></pre>

element Altri_Redditi_Ass_Lavd_Type/AssegnoDelConiuge

diagram					
namespace	urn:www.agenziaentrate.gov.it:specificheTecniche:sco:730				
type	DatoCB_Type				
facets	<table border="0"> <tr> <td>Kind</td> <td>Value</td> </tr> <tr> <td>pattern</td> <td>[01]</td> </tr> </table>	Kind	Value	pattern	[01]
Kind	Value				
pattern	[01]				
source	<xs:element name="AssegnoDelConiuge" type="cm:DatoCB_Type" minOccurs="0"/>				

element Altri_Redditi_Ass_Lavd_Type/ImportoRedditoAssimilato

diagram	
---------	--

namespace	urn:www.agenziaentrate.gov.it:specificheTecniche:sco:730
type	DatoNP_Type
facets	Kind Value pattern [1-9]{1}[0-9]*
source	<xs:element name="ImportoRedditoAssimilato" type="cm:DatoNP_Type" minOccurs="0"/>

complexType Altri_Redditi_Diversi_Detr_Type

diagram	
namespace	urn:www.agenziaentrate.gov.it:specificheTecniche:sco:730
children	m730:Tipo_Reddito m730:RedditiRitenuteSpese
source	<xs:complexType name="Altri_Redditi_Diversi_Detr_Type"> <xs:sequence> <xs:element name="Tipo_Reddito" type="m730:Tipo_Reddito_Da1a4_Type"/> <xs:element name="RedditiRitenuteSpese" type="m730:Redditi_Ritenute_Spese_Type" minOccurs="0"/> </xs:sequence> </xs:complexType>

element Altri_Redditi_Diversi_Detr_Type/Tipo_Reddito

diagram	
namespace	urn:www.agenziaentrate.gov.it:specificheTecniche:sco:730
type	m730:Tipo_Reddito_Da1a4_Type
facets	Kind Value pattern [1-9] enumeration 1 enumeration 2 enumeration 3 enumeration 4
source	<xs:element name="Tipo_Reddito" type="m730:Tipo_Reddito_Da1a4_Type"/>

element Altri_Redditi_Diversi_Detr_Type/RedditiRitenuteSpese

diagram	
namespace	urn:www.agenziaentrate.gov.it:specificheTecniche:sco:730
type	m730:Redditi_Ritenute_Spese_Type
children	m730:ImportoReddito m730:ImportoRitenute m730:ImportoSpese
source	<xs:element name="RedditiRitenuteSpese" type="m730:Redditi_Ritenute_Spese_Type" minOccurs="0"/>

complexType **Altri_Reddito_Diversi_Type**

diagram	
namespace	urn:www.agenziaentrate.gov.it:specificheTecniche:sco:730
children	m730:TipoReddito m730:RedditoRitenuteSpese
source	<pre><xs:complexType name="Altri_Reddito_Diversi_Type"> <xs:sequence> <xs:element name="TipoReddito" type="m730:Tipo_Reddito_Da1a9_Type"/> <xs:element name="RedditoRitenuteSpese" type="m730:Reddito_Ritenute_Spese_Type" minOccurs="0"/> </xs:sequence> </xs:complexType></pre>

element **Altri_Reddito_Diversi_Type/TipoReddito**

diagram																							
namespace	urn:www.agenziaentrate.gov.it:specificheTecniche:sco:730																						
type	m730:Tipo_Reddito_Da1a9_Type																						
facets	<table border="1"> <thead> <tr> <th>Kind</th> <th>Value</th> </tr> </thead> <tbody> <tr> <td>pattern</td> <td>[1-9]{1}[0-9]*</td> </tr> <tr> <td>enumeration</td> <td>1</td> </tr> <tr> <td>enumeration</td> <td>2</td> </tr> <tr> <td>enumeration</td> <td>3</td> </tr> <tr> <td>enumeration</td> <td>4</td> </tr> <tr> <td>enumeration</td> <td>5</td> </tr> <tr> <td>enumeration</td> <td>6</td> </tr> <tr> <td>enumeration</td> <td>7</td> </tr> <tr> <td>enumeration</td> <td>8</td> </tr> <tr> <td>enumeration</td> <td>9</td> </tr> </tbody> </table>	Kind	Value	pattern	[1-9]{1}[0-9]*	enumeration	1	enumeration	2	enumeration	3	enumeration	4	enumeration	5	enumeration	6	enumeration	7	enumeration	8	enumeration	9
Kind	Value																						
pattern	[1-9]{1}[0-9]*																						
enumeration	1																						
enumeration	2																						
enumeration	3																						
enumeration	4																						
enumeration	5																						
enumeration	6																						
enumeration	7																						
enumeration	8																						
enumeration	9																						
source	<pre><xs:element name="TipoReddito" type="m730:Tipo_Reddito_Da1a9_Type"/></pre>																						

element **Altri_Reddito_Diversi_Type/RedditoRitenuteSpese**

diagram	
namespace	urn:www.agenziaentrate.gov.it:specificheTecniche:sco:730
type	m730:Reddito_Ritenute_Spese_Type
children	m730:ImportoReddito m730:ImportoRitenute m730:ImportoSpese
source	<pre><xs:element name="RedditoRitenuteSpese" type="m730:Reddito_Ritenute_Spese_Type" minOccurs="0"/></pre>

complexType **Altri_Reddito_Lavoro_Autonomo_Type**

diagram	
namespace	urn:www.agenziaentrate.gov.it:specificheTecniche:sco:730
children	m730:TipoReddito m730:RedditiRitenute
source	<pre><xs:complexType name="Altri_Reddito_Lavoro_Autonomo_Type"> <xs:sequence> <xs:element name="TipoReddito" type="m730:Tipo_Reddito_Da1a3_Type"/> <xs:element name="RedditiRitenute" type="m730:Redditi_Ritenute_Type" minOccurs="0"/> </xs:sequence> </xs:complexType></pre>

element **Altri_Reddito_Lavoro_Autonomo_Type/TipoReddito**

diagram											
namespace	urn:www.agenziaentrate.gov.it:specificheTecniche:sco:730										
type	m730:Tipo_Reddito_Da1a3_Type										
facets	<table border="1"> <thead> <tr> <th>Kind</th> <th>Value</th> </tr> </thead> <tbody> <tr> <td>pattern</td> <td>[1-9]</td> </tr> <tr> <td>enumeration</td> <td>1</td> </tr> <tr> <td>enumeration</td> <td>2</td> </tr> <tr> <td>enumeration</td> <td>3</td> </tr> </tbody> </table>	Kind	Value	pattern	[1-9]	enumeration	1	enumeration	2	enumeration	3
Kind	Value										
pattern	[1-9]										
enumeration	1										
enumeration	2										
enumeration	3										
source	<pre><xs:element name="TipoReddito" type="m730:Tipo_Reddito_Da1a3_Type"/></pre>										

element **Altri_Reddito_Lavoro_Autonomo_Type/RedditiRitenute**

diagram	
namespace	urn:www.agenziaentrate.gov.it:specificheTecniche:sco:730
type	m730:Redditi_Ritenute_Type
children	m730:ImportoRedditi m730:ImportoRitenute
source	<pre><xs:element name="RedditiRitenute" type="m730:Redditi_Ritenute_Type" minOccurs="0"/></pre>

complexType **Altri_Reddito_Type**

diagram	
namespace	urn:www.agenziaentrate.gov.it:specificheTecniche:sco:730
children	m730:Modulo
source	<pre><xs:complexType name="Altri_Reddito_Type"> <xs:annotation/> <xs:sequence> <xs:element name="Modulo" type="m730:Modulo" minOccurs="1" maxOccurs="∞"/> </xs:sequence> </xs:complexType></pre>

	<pre> <xs:documentation>Quadro D - Altri Redditi</xs:documentation> </xs:annotation> <xs:sequence> <xs:element name="Modulo" type="m730:Modulo_Altri_Redditi_Type" maxOccurs="unbounded"/> </xs:sequence> </xs:complexType> </pre>
--	--

element **Altri_Redditi_Type/Modulo**

diagram	
namespace	urn:www.agenziaentrate.gov.it:specificheTecniche:sco:730
type	m730:Modulo_Altri_Redditi_Type
children	m730:RedditiDiCapitale m730:RedditiTassazioneSeparata
source	<pre><xs:element name="Modulo" type="m730:Modulo_Altri_Redditi_Type" maxOccurs="unbounded"/></pre>

complexType **Altri_Redditi_Utili_Type**

diagram	
namespace	urn:www.agenziaentrate.gov.it:specificheTecniche:sco:730
children	m730:Tipo_Reddito m730:RedditiRitenute
source	<pre> <xs:complexType name="Altri_Redditi_Utili_Type"> <xs:sequence> <xs:element name="Tipo_Reddito" type="m730:Tipo_Reddito_Da1a6_Type"/> <xs:element name="RedditiRitenute" type="m730:Redditi_Ritenute_Type" minOccurs="0"/> </xs:sequence> </xs:complexType> </pre>

element **Altri_Redditi_Utili_Type/Tipo_Reddito**

diagram																	
namespace	urn:www.agenziaentrate.gov.it:specificheTecniche:sco:730																
type	m730:Tipo_Reddito_Da1a6_Type																
facets	<table border="1"> <thead> <tr> <th>Kind</th> <th>Value</th> </tr> </thead> <tbody> <tr> <td>pattern</td> <td>[1-9]</td> </tr> <tr> <td>enumeration</td> <td>1</td> </tr> <tr> <td>enumeration</td> <td>2</td> </tr> <tr> <td>enumeration</td> <td>3</td> </tr> <tr> <td>enumeration</td> <td>4</td> </tr> <tr> <td>enumeration</td> <td>5</td> </tr> <tr> <td>enumeration</td> <td>6</td> </tr> </tbody> </table>	Kind	Value	pattern	[1-9]	enumeration	1	enumeration	2	enumeration	3	enumeration	4	enumeration	5	enumeration	6
Kind	Value																
pattern	[1-9]																
enumeration	1																
enumeration	2																
enumeration	3																
enumeration	4																
enumeration	5																
enumeration	6																
source	<pre><xs:element name="Tipo_Reddito" type="m730:Tipo_Reddito_Da1a6_Type"/></pre>																

element **Altri_Reddit_Utili_Type/RedditiRitenute**

diagram	
namespace	urn:www.agenziaentrate.gov.it:specificheTecniche:sco:730
type	m730:Redditi_Ritenute_Type
children	m730:ImportoRedditi m730:ImportoRitenute
source	<code><xs:element name="RedditiRitenute" type="m730:Redditi_Ritenute_Type" minOccurs="0"/></code>

complexType **Annotazione_Type**

diagram	
namespace	urn:www.agenziaentrate.gov.it:specificheTecniche:sco:730
children	m730:Codice m730:RigoQuadro m730:ModuloQuadro m730:Importo
source	<pre> <xs:complexType name="Annotazione_Type"> <xs:sequence> <xs:element name="Codice" type="cm:DatoAN_Type"/> <xs:element name="RigoQuadro" type="cm:DatoNP_Type" minOccurs="0"/> <xs:element name="ModuloQuadro" type="cm:DatoNP_Type" minOccurs="0"/> <xs:element name="Importo" type="cm:DatoNP_Type" minOccurs="0"/> </xs:sequence> </xs:complexType> </pre>

element **Annotazione_Type/Codice**

diagram					
namespace	urn:www.agenziaentrate.gov.it:specificheTecniche:sco:730				
type	DatoAN_Type				
facets	<table border="1"> <thead> <tr> <th>Kind</th> <th>Value</th> </tr> </thead> <tbody> <tr> <td>pattern</td> <td>([0-9A-Z- &quot;]{1})([0-9A-Z&amp;:] ' - \., / ° °\(\) À È É Ì Ò Ù Û &quot; \N\ +)*</td> </tr> </tbody> </table>	Kind	Value	pattern	([0-9A-Z- "]{1})([0-9A-Z&:] ' - \., / ° °\(\) À È É Ì Ò Ù Û " \N\ +)*
Kind	Value				
pattern	([0-9A-Z- "]{1})([0-9A-Z&:] ' - \., / ° °\(\) À È É Ì Ò Ù Û " \N\ +)*				
source	<code><xs:element name="Codice" type="cm:DatoAN_Type"/></code>				

element **Annotazione_Type/RigoQuadro**

diagram	
namespace	urn:www.agenziaentrate.gov.it:specificheTecniche:sco:730

type	DatoNP_Type
facets	Kind Value pattern [1-9]{1}[0-9]*
source	<xs:element name="RigoQuadro" type="cm:DatoNP_Type" minOccurs="0"/>

element **Annotazione_Type/ModuloQuadro**

diagram	
namespace	urn:www.agenziaentrate.gov.it:specificheTecniche:sco:730
type	DatoNP_Type
facets	Kind Value pattern [1-9]{1}[0-9]*
source	<xs:element name="ModuloQuadro" type="cm:DatoNP_Type" minOccurs="0"/>

element **Annotazione_Type/Importo**

diagram	
namespace	urn:www.agenziaentrate.gov.it:specificheTecniche:sco:730
type	DatoNP_Type
facets	Kind Value pattern [1-9]{1}[0-9]*
source	<xs:element name="Importo" type="cm:DatoNP_Type" minOccurs="0"/>

complexType **Assegno_Coniuge_Type**

diagram	
namespace	urn:www.agenziaentrate.gov.it:specificheTecniche:sco:730
children	m730:CodiceFiscale m730:Importo
source	<xs:complexType name="Assegno_Coniuge_Type"> <xs:sequence> <xs:element name="CodiceFiscale" type="cm:DatoCF_Type"/> <xs:element name="Importo" type="cm:DatoNP_Type"/> </xs:sequence> </xs:complexType>

element **Assegno_Coniuge_Type/CodiceFiscale**

diagram	
namespace	urn:www.agenziaentrate.gov.it:specificheTecniche:sco:730
type	DatoCF_Type
facets	Kind Value pattern [0-9]{11}[A-Z]{6}[0-9LMNPQRSTUUV]{2}[A-Z]{1}[0-9LMNPQRSTUUV]{2}[A-Z]{1}[0-9LMNPQRSTUUV]{3}[A-Z]{1}
source	<xs:element name="CodiceFiscale" type="cm:DatoCF_Type"/>

element **Assegno_Coniuge_Type/Importo**

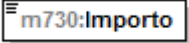
diagram					
namespace	urn:www.agenziaentrate.gov.it:specificheTecniche:sco:730				
type	DatoNP_Type				
facets	<table border="1"> <thead> <tr> <th>Kind</th> <th>Value</th> </tr> </thead> <tbody> <tr> <td>pattern</td> <td>[1-9]{1}[0-9]*</td> </tr> </tbody> </table>	Kind	Value	pattern	[1-9]{1}[0-9]*
Kind	Value				
pattern	[1-9]{1}[0-9]*				
source	<code><xs:element name="Importo" type="cm:DatoNP_Type"/></code>				

complexType **Bonus_Irpef_Type**

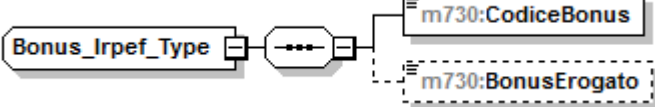
diagram	
namespace	urn:www.agenziaentrate.gov.it:specificheTecniche:sco:730
children	m730:CodiceBonus m730:BonusErogato
source	<pre> <xs:complexType name="Bonus_Irpef_Type"> <xs:sequence> <xs:element name="CodiceBonus"> <xs:simpleType> <xs:restriction base="cm:DatoN1_Type"> <xs:enumeration value="1"/> <xs:enumeration value="2"/> </xs:restriction> </xs:simpleType> </xs:element> <xs:element name="BonusErogato" type="cm:DatoNP_Type" minOccurs="0"/> </xs:sequence> </xs:complexType> </pre>

element **Bonus_Irpef_Type/CodiceBonus**

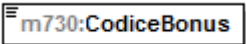
diagram									
namespace	urn:www.agenziaentrate.gov.it:specificheTecniche:sco:730								
type	restriction of DatoN1_Type								
facets	<table border="1"> <thead> <tr> <th>Kind</th> <th>Value</th> </tr> </thead> <tbody> <tr> <td>pattern</td> <td>[1-9]</td> </tr> <tr> <td>enumeration</td> <td>1</td> </tr> <tr> <td>enumeration</td> <td>2</td> </tr> </tbody> </table>	Kind	Value	pattern	[1-9]	enumeration	1	enumeration	2
Kind	Value								
pattern	[1-9]								
enumeration	1								
enumeration	2								
source	<pre> <xs:element name="CodiceBonus"> <xs:simpleType> <xs:restriction base="cm:DatoN1_Type"> <xs:enumeration value="1"/> <xs:enumeration value="2"/> </xs:restriction> </xs:simpleType> </xs:element> </pre>								

element **Bonus_Irpef_Type/BonusErogato**

diagram	
namespace	urn:www.agenziaentrate.gov.it:specificheTecniche:sco:730
type	DatoNP_Type
facets	Kind Value pattern [1-9]{1}[0-9]*
source	<code><xs:element name="BonusErogato" type="cm:DatoNP_Type" minOccurs="0"/></code>

complexType **Casella_Acconto_Type**

diagram	
namespace	urn:www.agenziaentrate.gov.it:specificheTecniche:sco:730
children	m730:Casella m730:ImportoMisuralInferiore
source	<code><xs:complexType name="Casella_Acconto_Type"> <xs:choice> <xs:element name="Casella" type="cm:DatoCB_Type" minOccurs="0"/> <xs:element name="ImportoMisuralInferiore" type="cm:DatoNP_Type" minOccurs="0"/> </xs:choice> </xs:complexType></code>

element **Casella_Acconto_Type/Casella**

diagram	
namespace	urn:www.agenziaentrate.gov.it:specificheTecniche:sco:730
type	DatoCB_Type
facets	Kind Value pattern [01]
source	<code><xs:element name="Casella" type="cm:DatoCB_Type" minOccurs="0"/></code>

element **Casella_Acconto_Type/ImportoMisuralInferiore**

diagram	
namespace	urn:www.agenziaentrate.gov.it:specificheTecniche:sco:730
type	DatoNP_Type
facets	Kind Value pattern [1-9]{1}[0-9]*
source	<code><xs:element name="ImportoMisuralInferiore" type="cm:DatoNP_Type" minOccurs="0"/></code>

complexType **Cedolare_Secca_Type**

diagram	
namespace	urn:www.agenziaentrate.gov.it:specificheTecniche:sco:730
children	m730:CedolareDovuta m730:EccedenzaCedolareSecca m730:AccontoCedolare
source	<pre><xs:complexType name="Cedolare_Secca_Type"> <xs:sequence> <xs:element name="CedolareDovuta" type="cm:DatoNP_Type" minOccurs="0"/> <xs:element name="EccedenzaCedolareSecca" type="cm:DatoNU_Type" minOccurs="0"/> <xs:element name="AccontoCedolare" type="cm:DatoNP_Type" minOccurs="0"/> </xs:sequence> </xs:complexType></pre>

element **Cedolare_Secca_Type/CedolareDovuta**

diagram					
namespace	urn:www.agenziaentrate.gov.it:specificheTecniche:sco:730				
type	DatoNP_Type				
facets	<table border="1"> <thead> <tr> <th>Kind</th> <th>Value</th> </tr> </thead> <tbody> <tr> <td>pattern</td> <td>[1-9]{1}[0-9]*</td> </tr> </tbody> </table>	Kind	Value	pattern	[1-9]{1}[0-9]*
Kind	Value				
pattern	[1-9]{1}[0-9]*				
source	<pre><xs:element name="CedolareDovuta" type="cm:DatoNP_Type" minOccurs="0"/></pre>				

element **Cedolare_Secca_Type/EccedenzaCedolareSecca**

diagram					
namespace	urn:www.agenziaentrate.gov.it:specificheTecniche:sco:730				
type	DatoNU_Type				
facets	<table border="1"> <thead> <tr> <th>Kind</th> <th>Value</th> </tr> </thead> <tbody> <tr> <td>pattern</td> <td>(\-[1-9] [1-9])[0-9]*</td> </tr> </tbody> </table>	Kind	Value	pattern	(\-[1-9] [1-9])[0-9]*
Kind	Value				
pattern	(\-[1-9] [1-9])[0-9]*				
source	<pre><xs:element name="EccedenzaCedolareSecca" type="cm:DatoNU_Type" minOccurs="0"/></pre>				

element **Cedolare_Secca_Type/AccontoCedolare**

diagram					
namespace	urn:www.agenziaentrate.gov.it:specificheTecniche:sco:730				
type	DatoNP_Type				
facets	<table border="1"> <thead> <tr> <th>Kind</th> <th>Value</th> </tr> </thead> <tbody> <tr> <td>pattern</td> <td>[1-9]{1}[0-9]*</td> </tr> </tbody> </table>	Kind	Value	pattern	[1-9]{1}[0-9]*
Kind	Value				
pattern	[1-9]{1}[0-9]*				
source	<pre><xs:element name="AccontoCedolare" type="cm:DatoNP_Type" minOccurs="0"/></pre>				

complexType **Conguaglio_Type**

<p>diagram</p>	
<p>namespace</p>	<p>urn:www.agenziaentrate.gov.it:specificheTecniche:sco:730</p>
<p>children</p>	<p>m730:NumeroRate m730:ImportoTrattenutoSaldo m730:ImportoTrattenutoAcconto m730:ImportoDaVersareF24Saldo m730:ImportoDaVersareF24Acconto m730:ImportoRimborsato m730:ImportoRimborsatoAgenzia m730:CasellaRimbAgenziaCasiPart m730:OpzioneInformativa</p>
<p>source</p>	<pre><xs:complexType name="Conguaglio_Type"> <xs:sequence> <xs:element name="NumeroRate" minOccurs="0"> <xs:simpleType> <xs:restriction base="cm:DatoN1_Type"> <xs:enumeration value="2"/> <xs:enumeration value="3"/> <xs:enumeration value="4"/> <xs:enumeration value="5"/> <xs:enumeration value="6"/> <xs:enumeration value="7"/> </xs:restriction> </xs:simpleType> </xs:element> <xs:element name="ImportoTrattenutoSaldo" type="cm:DatoNP_Type" minOccurs="0"/> <xs:element name="ImportoTrattenutoAcconto" type="cm:DatoNP_Type" minOccurs="0"/> <xs:element name="ImportoDaVersareF24Saldo" type="cm:DatoNP_Type" minOccurs="0"/> <xs:element name="ImportoDaVersareF24Acconto" type="cm:DatoNP_Type" minOccurs="0"/> <xs:element name="ImportoRimborsato" type="cm:DatoNP_Type" minOccurs="0"/> <xs:element name="ImportoRimborsatoAgenzia" type="cm:DatoNP_Type" minOccurs="0"/> <xs:element name="CasellaRimbAgenziaCasiPart" type="cm:DatoCB_Type" minOccurs="0"/> <xs:element name="OpzioneInformativa" type="cm:DatoCB_Type" minOccurs="0"/> </xs:sequence> </xs:complexType></pre>

element **Conguaglio_Type/NumeroRate**

<p>diagram</p>					
<p>namespace</p>	<p>urn:www.agenziaentrate.gov.it:specificheTecniche:sco:730</p>				
<p>type</p>	<p>restriction of DatoN1_Type</p>				
<p>facets</p>	<table border="1"> <tr> <td>Kind</td> <td>Value</td> </tr> <tr> <td>pattern</td> <td>[1-9]</td> </tr> </table>	Kind	Value	pattern	[1-9]
Kind	Value				
pattern	[1-9]				

	enumeration 2 enumeration 3 enumeration 4 enumeration 5 enumeration 6 enumeration 7
source	<pre><xs:element name="NumeroRate" minOccurs="0"> <xs:simpleType> <xs:restriction base="cm:DatoN1_Type"> <xs:enumeration value="2"/> <xs:enumeration value="3"/> <xs:enumeration value="4"/> <xs:enumeration value="5"/> <xs:enumeration value="6"/> <xs:enumeration value="7"/> </xs:restriction> </xs:simpleType> </xs:element></pre>

element **Conguaglio_Type/ImportoTrattenutoSaldo**

diagram					
namespace	urn:www.agenziaentrate.gov.it:specificheTecniche:sco:730				
type	DatoNP_Type				
facets	<table border="1"> <thead> <tr> <th>Kind</th> <th>Value</th> </tr> </thead> <tbody> <tr> <td>pattern</td> <td>[1-9]{1}[0-9]*</td> </tr> </tbody> </table>	Kind	Value	pattern	[1-9]{1}[0-9]*
Kind	Value				
pattern	[1-9]{1}[0-9]*				
source	<pre><xs:element name="ImportoTrattenutoSaldo" type="cm:DatoNP_Type" minOccurs="0"/></pre>				

element **Conguaglio_Type/ImportoTrattenutoAcconto**

diagram					
namespace	urn:www.agenziaentrate.gov.it:specificheTecniche:sco:730				
type	DatoNP_Type				
facets	<table border="1"> <thead> <tr> <th>Kind</th> <th>Value</th> </tr> </thead> <tbody> <tr> <td>pattern</td> <td>[1-9]{1}[0-9]*</td> </tr> </tbody> </table>	Kind	Value	pattern	[1-9]{1}[0-9]*
Kind	Value				
pattern	[1-9]{1}[0-9]*				
source	<pre><xs:element name="ImportoTrattenutoAcconto" type="cm:DatoNP_Type" minOccurs="0"/></pre>				

element **Conguaglio_Type/ImportoDaVersareF24Saldo**

diagram					
namespace	urn:www.agenziaentrate.gov.it:specificheTecniche:sco:730				
type	DatoNP_Type				
facets	<table border="1"> <thead> <tr> <th>Kind</th> <th>Value</th> </tr> </thead> <tbody> <tr> <td>pattern</td> <td>[1-9]{1}[0-9]*</td> </tr> </tbody> </table>	Kind	Value	pattern	[1-9]{1}[0-9]*
Kind	Value				
pattern	[1-9]{1}[0-9]*				
source	<pre><xs:element name="ImportoDaVersareF24Saldo" type="cm:DatoNP_Type" minOccurs="0"/></pre>				

element **Conguaglio_Type/ImportoDaVersareF24Acconto**

diagram	
---------	--

namespace	urn:www.agenziaentrate.gov.it:specificheTecniche:sco:730
type	DatoNP_Type
facets	Kind Value pattern [1-9]{1}[0-9]*
source	<xs:element name="ImportoDaVersareF24Acconto" type="cm:DatoNP_Type" minOccurs="0"/>

element **Conguaglio_Type/ImportoRimborsato**

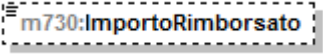
diagram	
namespace	urn:www.agenziaentrate.gov.it:specificheTecniche:sco:730
type	DatoNP_Type
facets	Kind Value pattern [1-9]{1}[0-9]*
source	<xs:element name="ImportoRimborsato" type="cm:DatoNP_Type" minOccurs="0"/>

element **Conguaglio_Type/ImportoRimborsatoAgenzia**

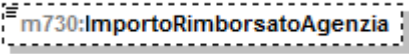
diagram	
namespace	urn:www.agenziaentrate.gov.it:specificheTecniche:sco:730
type	DatoNP_Type
facets	Kind Value pattern [1-9]{1}[0-9]*
source	<xs:element name="ImportoRimborsatoAgenzia" type="cm:DatoNP_Type" minOccurs="0"/>

element **Conguaglio_Type/CasellaRimbAgenziaCasiPart**

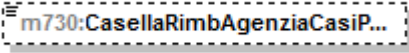
diagram	
namespace	urn:www.agenziaentrate.gov.it:specificheTecniche:sco:730
type	DatoCB_Type
facets	Kind Value pattern [01]
source	<xs:element name="CasellaRimbAgenziaCasiPart" type="cm:DatoCB_Type" minOccurs="0"/>

element **Conguaglio_Type/OpzioneInformativa**

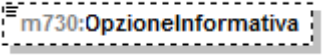
diagram	
namespace	urn:www.agenziaentrate.gov.it:specificheTecniche:sco:730
type	DatoCB_Type
facets	Kind Value pattern [01]
source	<xs:element name="OpzioneInformativa" type="cm:DatoCB_Type" minOccurs="0"/>

complexType **Contributi_Previdenza_Complementare_Type**

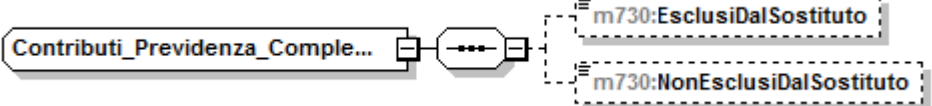
diagram	
namespace	urn:www.agenziaentrate.gov.it:specificheTecniche:sco:730
children	m730:EsclusiDalSostituto m730:NonEsclusiDalSostituto
source	<pre><xs:complexType name="Contributi_Previdenza_Complementare_Type"> <xs:sequence> <xs:element name="EsclusiDalSostituto" type="cm:DatoNP_Type" minOccurs="0"/> <xs:element name="NonEsclusiDalSostituto" type="cm:DatoNP_Type" minOccurs="0"/> </xs:sequence> </xs:complexType></pre>

element **Contributi_Previdenza_Complementare_Type/EsclusiDalSostituto**

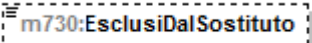
diagram	
namespace	urn:www.agenziaentrate.gov.it:specificheTecniche:sco:730
type	DatoNP_Type
facets	Kind Value pattern [1-9]{1}[0-9]*
source	<pre><xs:element name="EsclusiDalSostituto" type="cm:DatoNP_Type" minOccurs="0"/></pre>

element **Contributi_Previdenza_Complementare_Type/NonEsclusiDalSostituto**

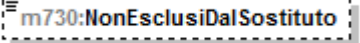
diagram	
namespace	urn:www.agenziaentrate.gov.it:specificheTecniche:sco:730
type	DatoNP_Type
facets	Kind Value pattern [1-9]{1}[0-9]*
source	<pre><xs:element name="NonEsclusiDalSostituto" type="cm:DatoNP_Type" minOccurs="0"/></pre>

complexType **Contributo_Solidarieta_Type**

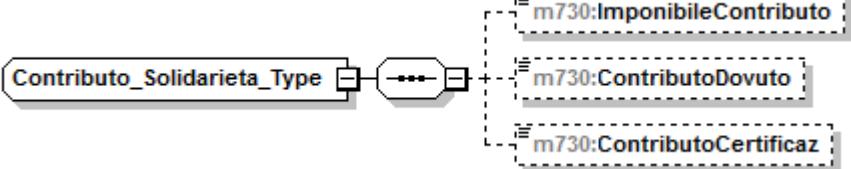
diagram	
namespace	urn:www.agenziaentrate.gov.it:specificheTecniche:sco:730
children	m730:ImponibileContributo m730:ContributoDovuto m730:ContributoCertificaz
source	<pre><xs:complexType name="Contributo_Solidarieta_Type"> <xs:sequence> <xs:element name="ImponibileContributo" type="cm:DatoNP_Type" minOccurs="0"/> <xs:element name="ContributoDovuto" type="cm:DatoNP_Type" minOccurs="0"/> <xs:element name="ContributoCertificaz" type="cm:DatoNP_Type" minOccurs="0"/> </xs:sequence> </xs:complexType></pre>

	<code></xs:complexType></code>
--	--------------------------------------

element **Contributo_Solidarieta_Type/ImponibileContributo**

diagram	
namespace	urn:www.agenziaentrate.gov.it:specificheTecniche:sco:730
type	DatoNP_Type
facets	Kind Value pattern [1-9]{1}[0-9]*
source	<code><xs:element name="ImponibileContributo" type="cm:DatoNP_Type" minOccurs="0"/></code>

element **Contributo_Solidarieta_Type/ContributoDovuto**

diagram	
namespace	urn:www.agenziaentrate.gov.it:specificheTecniche:sco:730
type	DatoNP_Type
facets	Kind Value pattern [1-9]{1}[0-9]*
source	<code><xs:element name="ContributoDovuto" type="cm:DatoNP_Type" minOccurs="0"/></code>

element **Contributo_Solidarieta_Type/ContributoCertificaz**

diagram	
namespace	urn:www.agenziaentrate.gov.it:specificheTecniche:sco:730
type	DatoNP_Type
facets	Kind Value pattern [1-9]{1}[0-9]*
source	<code><xs:element name="ContributoCertificaz" type="cm:DatoNP_Type" minOccurs="0"/></code>

complexType **Cred_Imp_Estero_Type**

diagram	
namespace	urn:www.agenziaentrate.gov.it:specificheTecniche:sco:730
children	m730:Anno m730:TotCredito m730:CreditoStato
source	<code><xs:complexType name="Cred_Imp_Estero_Type"> <xs:sequence> <xs:element name="Anno" type="cm:DatoDA_Type"/> <xs:element name="TotCredito" type="cm:DatoNP_Type"/> <xs:element name="CreditoStato" type="m730:Credito_Stato_Type" maxOccurs="2"/> </xs:sequence> </xs:complexType></code>

element **Cred_Imp_Estero_Type/Anno**

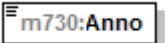
diagram	
namespace	urn:www.agenziaentrate.gov.it:specificheTecniche:sco:730
type	DatoDA_Type
facets	Kind Value pattern (18 19 20)[0-9]{2}
source	<xs:element name="Anno" type="cm:DatoDA_Type"/>

element **Cred_Imp_Estero_Type/TotCredito**

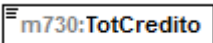
diagram	
namespace	urn:www.agenziaentrate.gov.it:specificheTecniche:sco:730
type	DatoNP_Type
facets	Kind Value pattern [1-9]{1}[0-9]*
source	<xs:element name="TotCredito" type="cm:DatoNP_Type"/>

element **Cred_Imp_Estero_Type/CreditoStato**

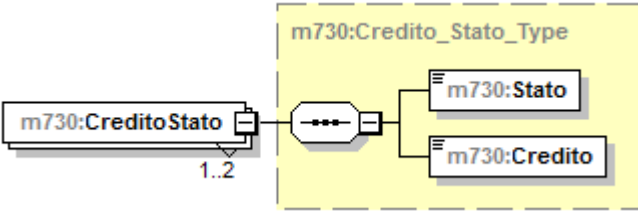
diagram	 <p>The diagram shows the structure of the m730:CreditoStato element. It is a container element with a cardinality of 1..2. Inside, there is a sequence of two child elements: m730:Stato and m730:Credito. The parent element is highlighted in yellow.</p>
namespace	urn:www.agenziaentrate.gov.it:specificheTecniche:sco:730
type	m730:Credito_Stato_Type
children	m730:Stato m730:Credito
source	<xs:element name="CreditoStato" type="m730:Credito_Stato_Type" maxOccurs="2"/>

complexType **Crediti_F24_Type**

<p>diagram</p>	
<p>namespace</p>	<p>urn:www.agenziaentrate.gov.it:specificheTecniche:sco:730</p>
<p>children</p>	<p>m730:Credlrpef m730:CredlrpefDipNoSostituto m730:CodAddReg m730:CredAddReg m730:CredAddRegDipNoSostituto m730:CodiceAddCom m730:CredAddCom m730:CredAddComDipNoSostituto m730:CredCedolare m730:CredCedolareDipNoSostituto m730:CredTassSeparDipNoSostituto m730:CredProduttivitaDipNoSostituto m730:CredSolidarietaDipNoSostituto m730:Totale m730:TotaleDipNoSostituto</p>
<p>source</p>	<pre><xs:complexType name="Crediti_F24_Type"> <xs:sequence> <xs:element name="Credlrpef" type="cm:DatoNP_Type" minOccurs="0"/> <xs:element name="CredlrpefDipNoSostituto" type="cm:DatoNP_Type" minOccurs="0"/> <xs:element name="CodAddReg" type="sc:Codice_Regione_Type" minOccurs="0"/> <xs:element name="CredAddReg" type="cm:DatoNP_Type" minOccurs="0"/> <xs:element name="CredAddRegDipNoSostituto" type="cm:DatoNP_Type" minOccurs="0"/> <xs:element name="CodiceAddCom" type="cm:DatoAN_Type" minOccurs="0"/> <xs:element name="CredAddCom" type="cm:DatoNP_Type" minOccurs="0"/> <xs:element name="CredAddComDipNoSostituto" type="cm:DatoNP_Type" minOccurs="0"/> <xs:element name="CredCedolare" type="cm:DatoNP_Type" minOccurs="0"/> <xs:element name="CredCedolareDipNoSostituto" type="cm:DatoNP_Type" minOccurs="0"/> <xs:element name="CredTassSeparDipNoSostituto" type="cm:DatoNP_Type" minOccurs="0"/> <xs:element name="CredProduttivitaDipNoSostituto" type="cm:DatoNP_Type" minOccurs="0"/> <xs:element name="CredSolidarietaDipNoSostituto" type="cm:DatoNP_Type" minOccurs="0"/> <xs:element name="Totale" type="cm:DatoNP_Type" minOccurs="0"/> <xs:element name="TotaleDipNoSostituto" type="cm:DatoNP_Type" minOccurs="0"/> </xs:sequence> </xs:complexType></pre>

element **Crediti_F24_Type/Credlrpef**

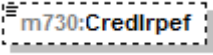
diagram	
namespace	urn:www.agenziaentrate.gov.it:specificheTecniche:sco:730
type	DatoNP_Type
facets	Kind Value pattern [1-9]{1}[0-9]*
source	<xs:element name="Credlrpef" type="cm:DatoNP_Type" minOccurs="0"/>

element **Crediti_F24_Type/CredlrpefDipNoSostituto**

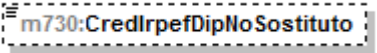
diagram	
namespace	urn:www.agenziaentrate.gov.it:specificheTecniche:sco:730
type	DatoNP_Type
facets	Kind Value pattern [1-9]{1}[0-9]*
source	<xs:element name="CredlrpefDipNoSostituto" type="cm:DatoNP_Type" minOccurs="0"/>

element **Crediti_F24_Type/CodAddReg**

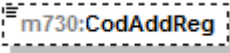
diagram	
namespace	urn:www.agenziaentrate.gov.it:specificheTecniche:sco:730
type	Codice_Regione_Type
facets	Kind Value pattern ([0-9A-Z\-\-] "){1}([0-9A-Z&] '\-\. , /° √\(\)\ À É Ê Ï Ò Ù Û Ü " \ \\ / +)* enumeration 1 enumeration 2 enumeration 3 enumeration 4 enumeration 5 enumeration 6 enumeration 7 enumeration 8 enumeration 9 enumeration 10 enumeration 11 enumeration 12 enumeration 13 enumeration 14 enumeration 15 enumeration 16 enumeration 17 enumeration 18 enumeration 19 enumeration 20 enumeration 21
source	<xs:element name="CodAddReg" type="sc:Codice_Regione_Type" minOccurs="0"/>

element **Crediti_F24_Type/CredAddReg**

diagram	
namespace	urn:www.agenziaentrate.gov.it:specificheTecniche:sco:730
type	DatoNP_Type
facets	Kind Value pattern [1-9]{1}[0-9]*
source	<xs:element name="CredAddReg" type="cm:DatoNP_Type" minOccurs="0"/>

element **Crediti_F24_Type/CredAddRegDipNoSostituto**

diagram	
namespace	urn:www.agenziaentrate.gov.it:specificheTecniche:sco:730
type	DatoNP_Type
facets	Kind Value pattern [1-9]{1}[0-9]*
source	<xs:element name="CredAddRegDipNoSostituto" type="cm:DatoNP_Type" minOccurs="0"/>

element **Crediti_F24_Type/CodiceAddCom**

diagram	
namespace	urn:www.agenziaentrate.gov.it:specificheTecniche:sco:730
type	DatoAN_Type
facets	Kind Value pattern (([0-9A-Z- "]){1}([0-9A-Z&:] \\-\\. , / ^\\(\\) À È É Ì Ò Ù Û " \\ \\ \\+))*
source	<xs:element name="CodiceAddCom" type="cm:DatoAN_Type" minOccurs="0"/>

element **Crediti_F24_Type/CredAddCom**

diagram	
namespace	urn:www.agenziaentrate.gov.it:specificheTecniche:sco:730
type	DatoNP_Type
facets	Kind Value pattern [1-9]{1}[0-9]*
source	<xs:element name="CredAddCom" type="cm:DatoNP_Type" minOccurs="0"/>

element **Crediti_F24_Type/CredAddComDipNoSostituto**

diagram	
namespace	urn:www.agenziaentrate.gov.it:specificheTecniche:sco:730
type	DatoNP_Type
facets	Kind Value pattern [1-9]{1}[0-9]*
source	<xs:element name="CredAddComDipNoSostituto" type="cm:DatoNP_Type" minOccurs="0"/>

element **Crediti_F24_Type/CredCedolare**

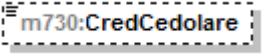
diagram	
namespace	urn:www.agenziaentrate.gov.it:specificheTecniche:sco:730
type	DatoNP_Type
facets	Kind Value pattern [1-9]{1}[0-9]*
source	<xs:element name="CredCedolare" type="cm:DatoNP_Type" minOccurs="0"/>

element **Crediti_F24_Type/CredCedolareDipNoSostituto**

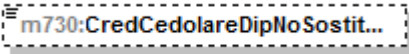
diagram	
namespace	urn:www.agenziaentrate.gov.it:specificheTecniche:sco:730
type	DatoNP_Type
facets	Kind Value pattern [1-9]{1}[0-9]*
source	<xs:element name="CredCedolareDipNoSostituto" type="cm:DatoNP_Type" minOccurs="0"/>

element **Crediti_F24_Type/CredTassSeparDipNoSostituto**

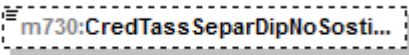
diagram	
namespace	urn:www.agenziaentrate.gov.it:specificheTecniche:sco:730
type	DatoNP_Type
facets	Kind Value pattern [1-9]{1}[0-9]*
source	<xs:element name="CredTassSeparDipNoSostituto" type="cm:DatoNP_Type" minOccurs="0"/>

element **Crediti_F24_Type/CredProduttivitaDipNoSostituto**

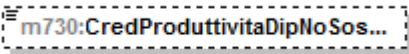
diagram	
namespace	urn:www.agenziaentrate.gov.it:specificheTecniche:sco:730
type	DatoNP_Type
facets	Kind Value pattern [1-9]{1}[0-9]*
source	<xs:element name="CredProduttivitaDipNoSostituto" type="cm:DatoNP_Type" minOccurs="0"/>

element **Crediti_F24_Type/CredSolidarietaDipNoSostituto**

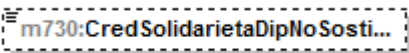
diagram	
namespace	urn:www.agenziaentrate.gov.it:specificheTecniche:sco:730
type	DatoNP_Type
facets	Kind Value pattern [1-9]{1}[0-9]*

source	<code><xs:element name="CredSolidarietaDipNoSostituto" type="cm:DatoNP_Type" minOccurs="0"/></code>
--------	---

element **Crediti_F24_Type/Totale**

diagram					
namespace	urn:www.agenziaentrate.gov.it:specificheTecniche:sco:730				
type	DatoNP_Type				
facets	<table border="1"> <tr> <th>Kind</th> <th>Value</th> </tr> <tr> <td>pattern</td> <td>[1-9]{1}[0-9]*</td> </tr> </table>	Kind	Value	pattern	[1-9]{1}[0-9]*
Kind	Value				
pattern	[1-9]{1}[0-9]*				
source	<code><xs:element name="Totale" type="cm:DatoNP_Type" minOccurs="0"/></code>				

element **Crediti_F24_Type/TotaleDipNoSostituto**

diagram					
namespace	urn:www.agenziaentrate.gov.it:specificheTecniche:sco:730				
type	DatoNP_Type				
facets	<table border="1"> <tr> <th>Kind</th> <th>Value</th> </tr> <tr> <td>pattern</td> <td>[1-9]{1}[0-9]*</td> </tr> </table>	Kind	Value	pattern	[1-9]{1}[0-9]*
Kind	Value				
pattern	[1-9]{1}[0-9]*				
source	<code><xs:element name="TotaleDipNoSostituto" type="cm:DatoNP_Type" minOccurs="0"/></code>				

complexType **Crediti_Imposta**

diagram	
namespace	urn:www.agenziaentrate.gov.it:specificheTecniche:sco:730
children	m730:PrimoModulo m730:Modulo
source	<pre> <xs:complexType name="Crediti_Imposta"> <xs:annotation> <xs:documentation>Quadro G - Crediti d'Imposta</xs:documentation> </xs:annotation> <xs:sequence> <xs:element name="PrimoModulo" type="m730:Primo_Modulo_Crediti_Imposta_Type"/> <xs:element name="Modulo" type="m730:Modulo_Crediti_Imposta_Type" minOccurs="0" maxOccurs="unbounded"/> </xs:sequence> </xs:complexType> </pre>

element **Crediti_Imposta/PrimoModulo**

<p>diagram</p>	
<p>namespace</p>	<p>urn:www.agenziaentrate.gov.it:specificheTecniche:sco:730</p>
<p>type</p>	<p>m730:Primo_Modulo_Crediti_Imposta_Type</p>
<p>children</p>	<p>m730:CreditoImpostaFabbricati m730:CreditoImpostaFondiPensione m730:CreditoImpostaRedditiEsteri m730:CreditoPrimaCasaSismaAbruzzo m730:CreditoAltriSismaAbruzzo m730:CreditoIncrementoOccupazione m730:CreditoImpostaMediazioni m730:CreditoErogazioniCultura</p>
<p>source</p>	<p><code><xs:element name="PrimoModulo" type="m730:Primo_Modulo_Crediti_Imposta_Type"/></code></p>

element **Crediti_Imposta/Modulo**

<p>diagram</p>	
<p>namespace</p>	<p>urn:www.agenziaentrate.gov.it:specificheTecniche:sco:730</p>
<p>type</p>	<p>m730:Modulo_Crediti_Imposta_Type</p>
<p>children</p>	<p>m730:CreditoImpostaFondiPensione m730:CreditoImpostaRedditiEsteri m730:CreditoPrimaCasaSismaAbruzzo m730:CreditoAltriSismaAbruzzo</p>
<p>source</p>	<p><code><xs:element name="Modulo" type="m730:Modulo_Crediti_Imposta_Type" minOccurs="0" maxOccurs="unbounded"/></code></p>

complexType **Crediti_Imposta_Altri_Sisma_Abruzzo_Type**

diagram	
namespace	urn:www.agenziaentrate.gov.it:specificheTecniche:sco:730
children	m730:Impresa_Professione m730:CreditoImmobileSismaA... m730:Rateazione
source	<pre><xs:complexType name="Crediti_Imposta_Altri_Sisma_Abruzzo_Type"> <xs:sequence> <xs:element name="Impresa_Professione" type="cm:DatoCB_Type" minOccurs="0"/> <xs:element name="CreditoImmobileSismaA..." type="m730:Credito_Immobile_Sisma_Abruzzo_Type" minOccurs="0"/> <xs:element name="Rateazione" type="m730:Numero_Rate5o10_Type" minOccurs="0"/> </xs:sequence> </xs:complexType></pre>

element **Crediti_Imposta_Altri_Sisma_Abruzzo_Type/Impresa_Professione**

diagram					
namespace	urn:www.agenziaentrate.gov.it:specificheTecniche:sco:730				
type	DatoCB_Type				
facets	<table border="1"> <thead> <tr> <th>Kind</th> <th>Value</th> </tr> </thead> <tbody> <tr> <td>pattern</td> <td>[01]</td> </tr> </tbody> </table>	Kind	Value	pattern	[01]
Kind	Value				
pattern	[01]				
source	<pre><xs:element name="Impresa_Professione" type="cm:DatoCB_Type" minOccurs="0"/></pre>				

element **Crediti_Imposta_Altri_Sisma_Abruzzo_Type/CreditoImmobileSismaAbruzzo**

diagram	
namespace	urn:www.agenziaentrate.gov.it:specificheTecniche:sco:730
type	m730:Credito_Immobile_Sisma_Abruzzo_Type
children	m730:CodiceFiscale m730:NumeroRata m730:TotaleCredito
source	<pre><xs:element name="CreditoImmobileSismaAbruzzo" type="m730:Credito_Immobile_Sisma_Abruzzo_Type" minOccurs="0"/></pre>

element **Crediti_Imposta_Altri_Sisma_Abruzzo_Type/Rateazione**

diagram	
namespace	urn:www.agenziaentrate.gov.it:specificheTecniche:sco:730

type	m730:Numero_Rate5o10_Type	
facets	Kind	Value
	pattern	[1-9]{1}[0-9]*
	enumeration	5
	enumeration	10
source	<xs:element name="Rateazione" type="m730:Numero_Rate5o10_Type" minOccurs="0"/>	

complexType [Crediti_Imposta_Fabbicati_Type](#)

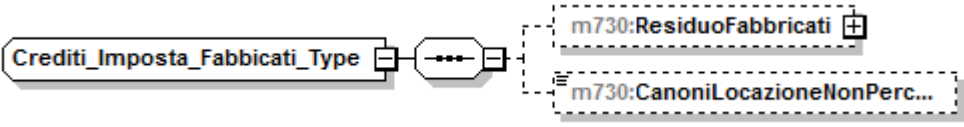
diagram		
namespace	urn:www.agenziaentrate.gov.it:specificheTecniche:sco:730	
children	m730:ResiduoFabbicati m730:CanoniLocazioneNonPercepiti	
source	<pre><xs:complexType name="Crediti_Imposta_Fabbicati_Type"> <xs:sequence> <xs:element name="ResiduoFabbicati" type="m730:Residuo_Credito_Compens_AnnolImposta_Type" minOccurs="0"/> <xs:element name="CanoniLocazioneNonPercepiti" type="cm:DatoNP_Type" minOccurs="0"/> </xs:sequence> </xs:complexType></pre>	

element [Crediti_Imposta_Fabbicati_Type/ResiduoFabbicati](#)

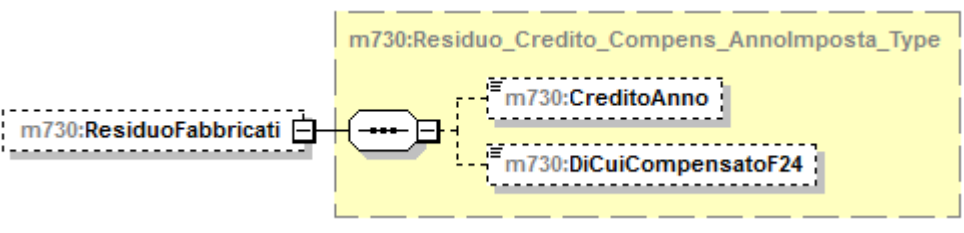
diagram		
namespace	urn:www.agenziaentrate.gov.it:specificheTecniche:sco:730	
type	m730:Residuo_Credito_Compens_AnnolImposta_Type	
children	m730:CreditoAnno m730:DiCuiCompensatoF24	
source	<xs:element name="ResiduoFabbicati" type="m730:Residuo_Credito_Compens_AnnolImposta_Type" minOccurs="0"/>	

element [Crediti_Imposta_Fabbicati_Type/CanoniLocazioneNonPercepiti](#)

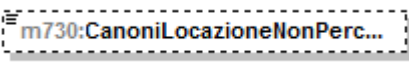
diagram		
namespace	urn:www.agenziaentrate.gov.it:specificheTecniche:sco:730	
type	DatoNP_Type	
facets	Kind	Value
	pattern	[1-9]{1}[0-9]*
source	<xs:element name="CanoniLocazioneNonPercepiti" type="cm:DatoNP_Type" minOccurs="0"/>	

complexType **Crediti_Imposta_Fondi_Pensione_Type**

diagram	
namespace	urn:www.agenziaentrate.gov.it:specificheTecniche:sco:730
children	m730:AnnoAnticipazione m730:Reintegro m730:SommaReintegrata m730:CreditoAnno
source	<pre><xs:complexType name="Crediti_Imposta_Fondi_Pensione_Type"> <xs:sequence> <xs:element name="AnnoAnticipazione" type="m730:Anno_Anticipazione_Fondo_Pensione_Type" minOccurs="0"/> <xs:element name="Reintegro" type="m730:Reintegro_Totale_Parziale_Type" minOccurs="0"/> <xs:element name="SommaReintegrata" type="cm:DatoNP_Type" minOccurs="0"/> <xs:element name="CreditoAnno" type="cm:DatoNP_Type" minOccurs="0"/> </xs:sequence> </xs:complexType></pre>

element **Crediti_Imposta_Fondi_Pensione_Type/AnnoAnticipazione**

diagram																					
namespace	urn:www.agenziaentrate.gov.it:specificheTecniche:sco:730																				
type	m730:Anno_Anticipazione_Fondo_Pensione_Type																				
facets	<table border="1"> <thead> <tr> <th>Kind</th> <th>Value</th> </tr> </thead> <tbody> <tr> <td>pattern</td> <td>[1-9]{1}[0-9]*</td> </tr> <tr> <td>enumeration</td> <td>2007</td> </tr> <tr> <td>enumeration</td> <td>2008</td> </tr> <tr> <td>enumeration</td> <td>2009</td> </tr> <tr> <td>enumeration</td> <td>2010</td> </tr> <tr> <td>enumeration</td> <td>2011</td> </tr> <tr> <td>enumeration</td> <td>2012</td> </tr> <tr> <td>enumeration</td> <td>2013</td> </tr> <tr> <td>enumeration</td> <td>2014</td> </tr> </tbody> </table>	Kind	Value	pattern	[1-9]{1}[0-9]*	enumeration	2007	enumeration	2008	enumeration	2009	enumeration	2010	enumeration	2011	enumeration	2012	enumeration	2013	enumeration	2014
Kind	Value																				
pattern	[1-9]{1}[0-9]*																				
enumeration	2007																				
enumeration	2008																				
enumeration	2009																				
enumeration	2010																				
enumeration	2011																				
enumeration	2012																				
enumeration	2013																				
enumeration	2014																				
source	<pre><xs:element name="AnnoAnticipazione" type="m730:Anno_Anticipazione_Fondo_Pensione_Type" minOccurs="0"/></pre>																				

element **Crediti_Imposta_Fondi_Pensione_Type/Reintegro**

diagram									
namespace	urn:www.agenziaentrate.gov.it:specificheTecniche:sco:730								
type	m730:Reintegro_Totale_Parziale_Type								
facets	<table border="1"> <thead> <tr> <th>Kind</th> <th>Value</th> </tr> </thead> <tbody> <tr> <td>pattern</td> <td>[1-9]</td> </tr> <tr> <td>enumeration</td> <td>1</td> </tr> <tr> <td>enumeration</td> <td>2</td> </tr> </tbody> </table>	Kind	Value	pattern	[1-9]	enumeration	1	enumeration	2
Kind	Value								
pattern	[1-9]								
enumeration	1								
enumeration	2								
source	<pre><xs:element name="Reintegro" type="m730:Reintegro_Totale_Parziale_Type" minOccurs="0"/></pre>								

element **Crediti Imposta Fondi Pensione_Type/SommaReintegrata**

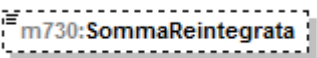
diagram	
namespace	urn:www.agenziaentrate.gov.it:specificheTecniche:sco:730
type	DatoNP_Type
facets	Kind Value pattern [1-9]{1}[0-9]*
source	<code><xs:element name="SommaReintegrata" type="cm:DatoNP_Type" minOccurs="0"/></code>

element **Crediti Imposta Fondi Pensione_Type/CreditoAnno**

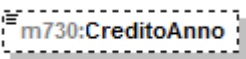
diagram	
namespace	urn:www.agenziaentrate.gov.it:specificheTecniche:sco:730
type	DatoNP_Type
facets	Kind Value pattern [1-9]{1}[0-9]*
source	<code><xs:element name="CreditoAnno" type="cm:DatoNP_Type" minOccurs="0"/></code>

complexType **Crediti Imposta Redditi Esteri_Type**

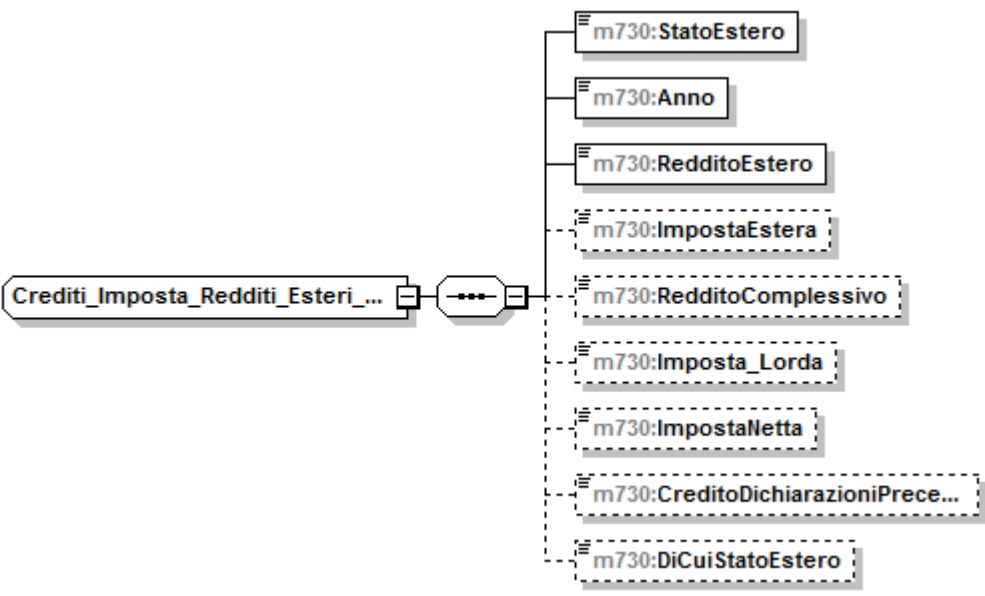
diagram	
namespace	urn:www.agenziaentrate.gov.it:specificheTecniche:sco:730
children	m730:StatoEstero m730:Anno m730:RedditoEstero m730:ImpostaEsteri m730:RedditoComplessivo m730:Imposta_Lorda m730:ImpostaNetta m730:CreditoDichiarazioniPrecedenti m730:DiCuiStatoEstero
source	<code><xs:complexType name="Crediti_Imposta_Redditi_Esteri_Type"> <xs:sequence> <xs:element name="StatoEstero" type="cm:DatoAN_Type"/> <xs:element name="Anno"> <xs:simpleType> <xs:restriction base="cm:DatoDA_Type"/> </xs:simpleType> </xs:element> <xs:element name="RedditoEstero" type="cm:DatoNP_Type"/> <xs:element name="ImpostaEsteri" type="cm:DatoNP_Type" minOccurs="0"/></code>

	<pre><xs:element name="RedditoComplessivo" type="cm:DatoNP_Type" minOccurs="0"/> <xs:element name="Imposta_Lorda" type="cm:DatoNP_Type" minOccurs="0"/> <xs:element name="ImpostaNetta" type="cm:DatoNP_Type" minOccurs="0"/> <xs:element name="CreditoDichiarazioniPrecedenti" type="cm:DatoNP_Type" minOccurs="0"/> <xs:element name="DiCuiStatoEstero" type="cm:DatoNP_Type" minOccurs="0"/> </xs:sequence> </xs:complexType></pre>
--	--

element **Crediti Imposta Redditi Esteri_Type/StatoEstero**

diagram	
namespace	urn:www.agenziaentrate.gov.it:specificheTecniche:sco:730
type	DatoAN_Type
facets	Kind Value pattern ([0-9A-Z\-\ "}){1}([0-9A-Z&:] \- \. , ° \^\(\ \)À É È Ì Ò Ù Ú Û " \ \\ \ +)*
source	<pre><xs:element name="StatoEstero" type="cm:DatoAN_Type"/></pre>

element **Crediti Imposta Redditi Esteri_Type/Anno**

diagram	
namespace	urn:www.agenziaentrate.gov.it:specificheTecniche:sco:730
type	restriction of DatoDA_Type
facets	Kind Value pattern (18 19 20)[0-9]{2}
source	<pre><xs:element name="Anno"> <xs:simpleType> <xs:restriction base="cm:DatoDA_Type"/> </xs:simpleType> </xs:element></pre>

element **Crediti Imposta Redditi Esteri_Type/RedditoEstero**

diagram	
namespace	urn:www.agenziaentrate.gov.it:specificheTecniche:sco:730
type	DatoNP_Type
facets	Kind Value pattern [1-9]{1}[0-9]*
source	<pre><xs:element name="RedditoEstero" type="cm:DatoNP_Type"/></pre>

element **Crediti Imposta Redditi Esteri_Type/ImpostaEsteri**

diagram	
namespace	urn:www.agenziaentrate.gov.it:specificheTecniche:sco:730
type	DatoNP_Type
facets	Kind Value pattern [1-9]{1}[0-9]*
source	<pre><xs:element name="ImpostaEsteri" type="cm:DatoNP_Type" minOccurs="0"/></pre>

element **Crediti_Imposta_Reddito_Esteri_Type/RedditoComplessivo**

diagram	
namespace	urn:www.agenziaentrate.gov.it:specificheTecniche:sco:730
type	DatoNP_Type
facets	Kind Value pattern [1-9]{1}[0-9]*
source	<code><xs:element name="RedditoComplessivo" type="cm:DatoNP_Type" minOccurs="0"/></code>

element **Crediti_Imposta_Reddito_Esteri_Type/Imposta_Lorda**

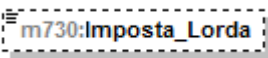
diagram	
namespace	urn:www.agenziaentrate.gov.it:specificheTecniche:sco:730
type	DatoNP_Type
facets	Kind Value pattern [1-9]{1}[0-9]*
source	<code><xs:element name="Imposta_Lorda" type="cm:DatoNP_Type" minOccurs="0"/></code>

element **Crediti_Imposta_Reddito_Esteri_Type/ImpostaNetta**

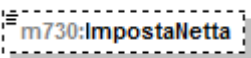
diagram	
namespace	urn:www.agenziaentrate.gov.it:specificheTecniche:sco:730
type	DatoNP_Type
facets	Kind Value pattern [1-9]{1}[0-9]*
source	<code><xs:element name="ImpostaNetta" type="cm:DatoNP_Type" minOccurs="0"/></code>

element **Crediti_Imposta_Reddito_Esteri_Type/CreditoDichiarazioniPrecedenti**

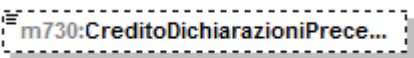
diagram	
namespace	urn:www.agenziaentrate.gov.it:specificheTecniche:sco:730
type	DatoNP_Type
facets	Kind Value pattern [1-9]{1}[0-9]*
source	<code><xs:element name="CreditoDichiarazioniPrecedenti" type="cm:DatoNP_Type" minOccurs="0"/></code>

element **Crediti_Imposta_Reddito_Esteri_Type/DiCuiStatoEstero**

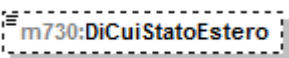
diagram	
namespace	urn:www.agenziaentrate.gov.it:specificheTecniche:sco:730
type	DatoNP_Type
facets	Kind Value pattern [1-9]{1}[0-9]*

source	<code><xs:element name="DiCuiStatoEstero" type="cm:DatoNP_Type" minOccurs="0"/></code>
--------	--

complexType **Credito_Immobile_Sisma_Abruzzo_Type**

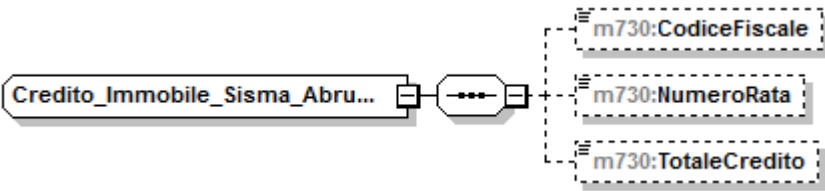
diagram	
namespace	urn:www.agenziaentrate.gov.it:specificheTecniche:sco:730
children	m730:CodiceFiscale m730:NumeroRata m730:TotaleCredito
source	<code><xs:complexType name="Credito_Immobile_Sisma_Abruzzo_Type"> <xs:sequence> <xs:element name="CodiceFiscale" type="cm:DatoCF_Type" minOccurs="0"/> <xs:element name="NumeroRata" type="m730:Numero_RateDa1A6_Type" minOccurs="0"/> <xs:element name="TotaleCredito" type="cm:DatoNP_Type" minOccurs="0"/> </xs:sequence> </xs:complexType></code>

element **Credito_Immobile_Sisma_Abruzzo_Type/CodiceFiscale**

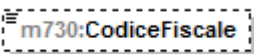
diagram					
namespace	urn:www.agenziaentrate.gov.it:specificheTecniche:sco:730				
type	DatoCF_Type				
facets	<table border="1"> <thead> <tr> <th>Kind</th> <th>Value</th> </tr> </thead> <tbody> <tr> <td>pattern</td> <td>[0-9]{11}[A-Z]{6}[0-9LMNPQRSTU]{2}[A-Z]{1}[0-9LMNPQRSTU]{2}[A-Z]{1}[0-9LMNPQRSTU]{3}[A-Z]{1}</td> </tr> </tbody> </table>	Kind	Value	pattern	[0-9]{11}[A-Z]{6}[0-9LMNPQRSTU]{2}[A-Z]{1}[0-9LMNPQRSTU]{2}[A-Z]{1}[0-9LMNPQRSTU]{3}[A-Z]{1}
Kind	Value				
pattern	[0-9]{11}[A-Z]{6}[0-9LMNPQRSTU]{2}[A-Z]{1}[0-9LMNPQRSTU]{2}[A-Z]{1}[0-9LMNPQRSTU]{3}[A-Z]{1}				
source	<code><xs:element name="CodiceFiscale" type="cm:DatoCF_Type" minOccurs="0"/></code>				

element **Credito_Immobile_Sisma_Abruzzo_Type/NumeroRata**

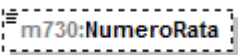
diagram																	
namespace	urn:www.agenziaentrate.gov.it:specificheTecniche:sco:730																
type	m730:Numero_RateDa1A6_Type																
facets	<table border="1"> <thead> <tr> <th>Kind</th> <th>Value</th> </tr> </thead> <tbody> <tr> <td>pattern</td> <td>[1-9]</td> </tr> <tr> <td>enumeration</td> <td>1</td> </tr> <tr> <td>enumeration</td> <td>2</td> </tr> <tr> <td>enumeration</td> <td>3</td> </tr> <tr> <td>enumeration</td> <td>4</td> </tr> <tr> <td>enumeration</td> <td>5</td> </tr> <tr> <td>enumeration</td> <td>6</td> </tr> </tbody> </table>	Kind	Value	pattern	[1-9]	enumeration	1	enumeration	2	enumeration	3	enumeration	4	enumeration	5	enumeration	6
Kind	Value																
pattern	[1-9]																
enumeration	1																
enumeration	2																
enumeration	3																
enumeration	4																
enumeration	5																
enumeration	6																
source	<code><xs:element name="NumeroRata" type="m730:Numero_RateDa1A6_Type" minOccurs="0"/></code>																

element **Credito_Immobile_Sisma_Abruzzo_Type/TotaleCredito**

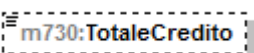
diagram	
namespace	urn:www.agenziaentrate.gov.it:specificheTecniche:sco:730

type	DatoNP_Type
facets	Kind Value pattern [1-9]{1}[0-9]*
source	<xs:element name="TotaleCredito" type="cm:DatoNP_Type" minOccurs="0"/>

complexType **Credito_Stato_Type**

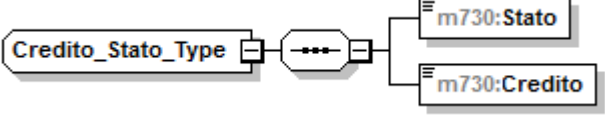
diagram	
namespace	urn:www.agenziaentrate.gov.it:specificheTecniche:sco:730
children	m730:Stato m730:Credito
source	<xs:complexType name="Credito_Stato_Type"> <xs:sequence> <xs:element name="Stato" type="cm:DatoAN_Type"/> <xs:element name="Credito" type="cm:DatoNP_Type"/> </xs:sequence> </xs:complexType>

element **Credito_Stato_Type/Stato**

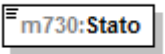
diagram	
namespace	urn:www.agenziaentrate.gov.it:specificheTecniche:sco:730
type	DatoAN_Type
facets	Kind Value pattern ([0-9A-Z\-\]"){1}([0-9A-Z&] \- \., / \^\(\ \)\À É È Ì Ò Ù Ú " \ \ /+)*
source	<xs:element name="Stato" type="cm:DatoAN_Type"/>

element **Credito_Stato_Type/Credito**

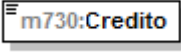
diagram	
namespace	urn:www.agenziaentrate.gov.it:specificheTecniche:sco:730
type	DatoNP_Type
facets	Kind Value pattern [1-9]{1}[0-9]*
source	<xs:element name="Credito" type="cm:DatoNP_Type"/>

complexType **Credito_Type**

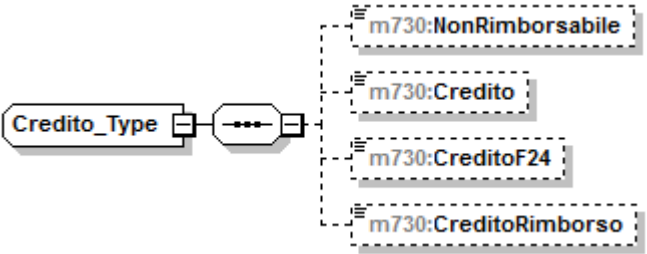
diagram	
---------	---

namespace	urn:www.agenziaentrate.gov.it:specificheTecniche:sco:730
children	m730:NonRimborsabile m730:Credito m730:CreditoF24 m730:CreditoRimborso
source	<pre><xs:complexType name="Credito_Type"> <xs:sequence> <xs:element name="NonRimborsabile" type="cm:DatoNP_Type" minOccurs="0"/> <xs:element name="Credito" type="cm:DatoNP_Type" minOccurs="0"/> <xs:element name="CreditoF24" type="cm:DatoNP_Type" minOccurs="0"/> <xs:element name="CreditoRimborso" type="cm:DatoNP_Type" minOccurs="0"/> </xs:sequence> </xs:complexType></pre>

element **Credito_Type/NonRimborsabile**

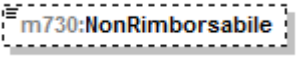
diagram					
namespace	urn:www.agenziaentrate.gov.it:specificheTecniche:sco:730				
type	DatoNP_Type				
facets	<table border="1"> <tr> <td>Kind</td> <td>Value</td> </tr> <tr> <td>pattern</td> <td>[1-9]{1}[0-9]*</td> </tr> </table>	Kind	Value	pattern	[1-9]{1}[0-9]*
Kind	Value				
pattern	[1-9]{1}[0-9]*				
source	<pre><xs:element name="NonRimborsabile" type="cm:DatoNP_Type" minOccurs="0"/></pre>				

element **Credito_Type/Credito**

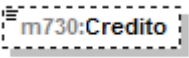
diagram					
namespace	urn:www.agenziaentrate.gov.it:specificheTecniche:sco:730				
type	DatoNP_Type				
facets	<table border="1"> <tr> <td>Kind</td> <td>Value</td> </tr> <tr> <td>pattern</td> <td>[1-9]{1}[0-9]*</td> </tr> </table>	Kind	Value	pattern	[1-9]{1}[0-9]*
Kind	Value				
pattern	[1-9]{1}[0-9]*				
source	<pre><xs:element name="Credito" type="cm:DatoNP_Type" minOccurs="0"/></pre>				

element **Credito_Type/CreditoF24**

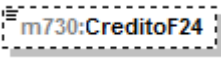
diagram					
namespace	urn:www.agenziaentrate.gov.it:specificheTecniche:sco:730				
type	DatoNP_Type				
facets	<table border="1"> <tr> <td>Kind</td> <td>Value</td> </tr> <tr> <td>pattern</td> <td>[1-9]{1}[0-9]*</td> </tr> </table>	Kind	Value	pattern	[1-9]{1}[0-9]*
Kind	Value				
pattern	[1-9]{1}[0-9]*				
source	<pre><xs:element name="CreditoF24" type="cm:DatoNP_Type" minOccurs="0"/></pre>				

element **Credito_Type/CreditoRimborso**

diagram					
namespace	urn:www.agenziaentrate.gov.it:specificheTecniche:sco:730				
type	DatoNP_Type				
facets	<table border="1"> <tr> <td>Kind</td> <td>Value</td> </tr> <tr> <td>pattern</td> <td>[1-9]{1}[0-9]*</td> </tr> </table>	Kind	Value	pattern	[1-9]{1}[0-9]*
Kind	Value				
pattern	[1-9]{1}[0-9]*				
source	<pre><xs:element name="CreditoRimborso" type="cm:DatoNP_Type" minOccurs="0"/></pre>				

complexType **Dati_730Integrativo_Type**

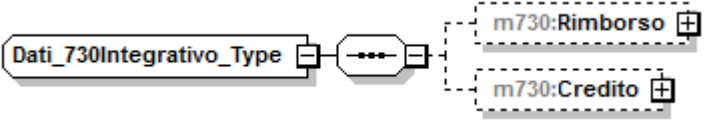
diagram	
namespace	urn:www.agenziaentrate.gov.it:specificheTecniche:sco:730
children	m730:Rimborso m730:Credito
source	<pre><xs:complexType name="Dati_730Integrativo_Type"> <xs:sequence> <xs:element name="Rimborso" type="m730:Elemento_Integrativo_Type" minOccurs="0"/> <xs:element name="Credito" type="m730:Elemento_Integrativo_Type" minOccurs="0"/> </xs:sequence> </xs:complexType></pre>

element **Dati_730Integrativo_Type/Rimborso**

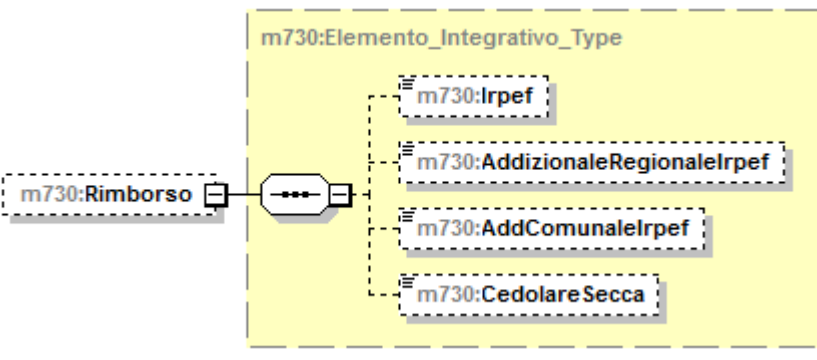
diagram	
namespace	urn:www.agenziaentrate.gov.it:specificheTecniche:sco:730
type	m730:Elemento_Integrativo_Type
children	m730:Irpef m730:AddizionaleRegionaleIrpef m730:AddComunaleIrpef m730:CedolareSecca
source	<pre><xs:element name="Rimborso" type="m730:Elemento_Integrativo_Type" minOccurs="0"/></pre>

element **Dati_730Integrativo_Type/Credito**

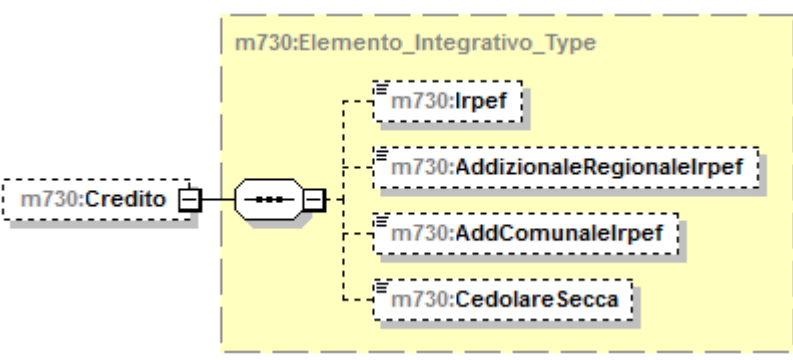
diagram	
namespace	urn:www.agenziaentrate.gov.it:specificheTecniche:sco:730
type	m730:Elemento_Integrativo_Type
children	m730:Irpef m730:AddizionaleRegionaleIrpef m730:AddComunaleIrpef m730:CedolareSecca

source	<xs:element name="Credito" type="m730:Elemento_Integrativo_Type" minOccurs="0"/>
--------	--

complexType **Dati_Altre_Detrazioni_Modulo_Type**

diagram	
namespace	urn:www.agenziaentrate.gov.it:specificheTecniche:sco:730
children	m730:AltreDetrazioni
source	<xs:complexType name="Dati_Altre_Detrazioni_Modulo_Type"> <xs:sequence> <xs:element name="AltreDetrazioni" type="m730:Altre_Detrazioni_Type" minOccurs="0"/> </xs:sequence> </xs:complexType>

element **Dati_Altre_Detrazioni_Modulo_Type/AltreDetrazioni**

diagram	
namespace	urn:www.agenziaentrate.gov.it:specificheTecniche:sco:730
type	m730:Altre_Detrazioni_Type
children	m730:Codice m730:Importo
source	<xs:element name="AltreDetrazioni" type="m730:Altre_Detrazioni_Type" minOccurs="0"/>

complexType **Dati_Altre_Detrazioni_Type**

diagram	
namespace	urn:www.agenziaentrate.gov.it:specificheTecniche:sco:730
children	m730:SpeseCaniGuida m730:AffittoTerreniAgricoliGiovani m730:AltreDetrazioni
source	<xs:complexType name="Dati_Altre_Detrazioni_Type"> <xs:sequence> <xs:element name="SpeseCaniGuida" type="cm:DatoCB_Type" minOccurs="0"/> <xs:element name="AffittoTerreniAgricoliGiovani" type="cm:DatoNP_Type" minOccurs="0"/> <xs:element name="AltreDetrazioni" type="m730:Altre_Detrazioni_Type" minOccurs="0"/> </xs:sequence> </xs:complexType>

element **Dati_Altre_Detrazioni_Type/SpeseCaniGuida**

diagram	
---------	--

namespace	urn:www.agenziaentrate.gov.it:specificheTecniche:sco:730
type	DatoCB_Type
facets	Kind Value pattern [01]
source	<xs:element name="SpeseCaniGuida" type="cm:DatoCB_Type" minOccurs="0"/>

element **Dati_Altre_Detrazioni_Type/AffittoTerreniAgricoliGiovani**

diagram	
namespace	urn:www.agenziaentrate.gov.it:specificheTecniche:sco:730
type	DatoNP_Type
facets	Kind Value pattern [1-9]{1}[0-9]*
source	<xs:element name="AffittoTerreniAgricoliGiovani" type="cm:DatoNP_Type" minOccurs="0"/>

element **Dati_Altre_Detrazioni_Type/AltreDetrazioni**

diagram	
namespace	urn:www.agenziaentrate.gov.it:specificheTecniche:sco:730
type	m730:Altre_Detrazioni_Type
children	m730:Codice m730:Importo
source	<xs:element name="AltreDetrazioni" type="m730:Altre_Detrazioni_Type" minOccurs="0"/>

complexType **Dati_Associazioni_Professionale_Type**

diagram	
namespace	urn:www.agenziaentrate.gov.it:specificheTecniche:sco:730
children	m730:CFAssociazione m730:DenominazioneAssociazione m730:CFProfessionista m730:CognomeProfessionista m730:NomeProfessionista
source	<xs:complexType name="Dati_Associazioni_Professionale_Type"> <xs:sequence> <xs:element name="CFAssociazione" type="cm:DatoCN_Type"/> <xs:element name="DenominazioneAssociazione" type="cm:DatoAN_Type"/>

	<pre><xs:element name="CFProfessionista" type="cm:DatoCF_Type"/> <xs:element name="CognomeProfessionista" type="cm:DatoAN_Type"/> <xs:element name="NomeProfessionista" type="cm:DatoAN_Type"/> </xs:sequence> </xs:complexType></pre>
--	--

element **Dati_Associazioni_Professionale_Type/CFAssociazione**

diagram					
namespace	urn:www.agenziaentrate.gov.it:specificheTecniche:sco:730				
type	DatoCN_Type				
facets	<table border="1"> <tr> <th>Kind</th> <th>Value</th> </tr> <tr> <td>pattern</td> <td>[0-9]{11}</td> </tr> </table>	Kind	Value	pattern	[0-9]{11}
Kind	Value				
pattern	[0-9]{11}				
source	<pre><xs:element name="CFAssociazione" type="cm:DatoCN_Type"/></pre>				

element **Dati_Associazioni_Professionale_Type/DenominazioneAssociazione**

diagram					
namespace	urn:www.agenziaentrate.gov.it:specificheTecniche:sco:730				
type	DatoAN_Type				
facets	<table border="1"> <tr> <th>Kind</th> <th>Value</th> </tr> <tr> <td>pattern</td> <td>([0-9A-Z\-\]&quot;){1}([0-9A-Z&amp;:] \- \., / ^ \^\(\ \)\À È É Ì Ò Ù Û &quot; \ \ \ +)*</td> </tr> </table>	Kind	Value	pattern	([0-9A-Z\-\]"){1}([0-9A-Z&:] \- \., / ^ \^\(\ \)\À È É Ì Ò Ù Û " \ \ \ +)*
Kind	Value				
pattern	([0-9A-Z\-\]"){1}([0-9A-Z&:] \- \., / ^ \^\(\ \)\À È É Ì Ò Ù Û " \ \ \ +)*				
source	<pre><xs:element name="DenominazioneAssociazione" type="cm:DatoAN_Type"/></pre>				

element **Dati_Associazioni_Professionale_Type/CFProfessionista**

diagram					
namespace	urn:www.agenziaentrate.gov.it:specificheTecniche:sco:730				
type	DatoCF_Type				
facets	<table border="1"> <tr> <th>Kind</th> <th>Value</th> </tr> <tr> <td>pattern</td> <td>[0-9]{11}[A-Z]{6}[0-9LMNPQRSTUWV]{2}[A-Z]{1}[0-9LMNPQRSTUWV]{2}[A-Z]{1}[0-9LMNPQRSTUWV]{3}[A-Z]{1}</td> </tr> </table>	Kind	Value	pattern	[0-9]{11}[A-Z]{6}[0-9LMNPQRSTUWV]{2}[A-Z]{1}[0-9LMNPQRSTUWV]{2}[A-Z]{1}[0-9LMNPQRSTUWV]{3}[A-Z]{1}
Kind	Value				
pattern	[0-9]{11}[A-Z]{6}[0-9LMNPQRSTUWV]{2}[A-Z]{1}[0-9LMNPQRSTUWV]{2}[A-Z]{1}[0-9LMNPQRSTUWV]{3}[A-Z]{1}				
source	<pre><xs:element name="CFProfessionista" type="cm:DatoCF_Type"/></pre>				

element **Dati_Associazioni_Professionale_Type/CognomeProfessionista**

diagram					
namespace	urn:www.agenziaentrate.gov.it:specificheTecniche:sco:730				
type	DatoAN_Type				
facets	<table border="1"> <tr> <th>Kind</th> <th>Value</th> </tr> <tr> <td>pattern</td> <td>([0-9A-Z\-\]&quot;){1}([0-9A-Z&amp;:] \- \., / ^ \^\(\ \)\À È É Ì Ò Ù Û &quot; \ \ \ +)*</td> </tr> </table>	Kind	Value	pattern	([0-9A-Z\-\]"){1}([0-9A-Z&:] \- \., / ^ \^\(\ \)\À È É Ì Ò Ù Û " \ \ \ +)*
Kind	Value				
pattern	([0-9A-Z\-\]"){1}([0-9A-Z&:] \- \., / ^ \^\(\ \)\À È É Ì Ò Ù Û " \ \ \ +)*				
source	<pre><xs:element name="CognomeProfessionista" type="cm:DatoAN_Type"/></pre>				

element **Dati_Associazioni_Professionale_Type/NomeProfessionista**

diagram	
---------	--

namespace	urn:www.agenziaentrate.gov.it:specificheTecniche:sco:730
type	DatoAN_Type
facets	Kind Value pattern ([0-9A-Z\-\] \"){1}([0-9A-Z&#92;] \\ \\. / ° °\ °\(\) À É È Ì Ò Ù Ú Û " \\ \\ /+)*
source	<xs:element name="NomeProfessionista" type="cm:DatoAN_Type"/>

complexType Dati_CAF_Type

diagram	<pre> sequenceDiagram participant D as Dati_CAF_Type D --> E1 as m730:CFCaf D --> E2 as m730:DenominazioneCaf D --> E3 as m730:NumeroAlbo </pre>
namespace	urn:www.agenziaentrate.gov.it:specificheTecniche:sco:730
children	m730:CFCaf m730:DenominazioneCaf m730:NumeroAlbo
source	<pre> <xs:complexType name="Dati_CAF_Type"> <xs:sequence> <xs:element name="CFCaf" type="cm:DatoCN_Type"/> <xs:element name="DenominazioneCaf" type="cm:DatoAN_Type"/> <xs:element name="NumeroAlbo"> <xs:simpleType> <xs:restriction base="cm:DatoNP_Type"> <xs:maxLength value="5"/> </xs:restriction> </xs:simpleType> </xs:element> </xs:sequence> </xs:complexType> </pre>

element Dati_CAF_Type/CFCaf

diagram	<pre> sequenceDiagram participant E as m730:CFCaf </pre>
namespace	urn:www.agenziaentrate.gov.it:specificheTecniche:sco:730
type	DatoCN_Type
facets	Kind Value pattern [0-9]{11}
source	<xs:element name="CFCaf" type="cm:DatoCN_Type"/>

element Dati_CAF_Type/DenominazioneCaf

diagram	<pre> sequenceDiagram participant E as m730:DenominazioneCaf </pre>
namespace	urn:www.agenziaentrate.gov.it:specificheTecniche:sco:730
type	DatoAN_Type
facets	Kind Value pattern ([0-9A-Z\-\] \"){1}([0-9A-Z&#92;] \\ \\. / ° °\ °\(\) À É È Ì Ò Ù Ú Û " \\ \\ /+)*
source	<xs:element name="DenominazioneCaf" type="cm:DatoAN_Type"/>

element **Dati_CAF_Type/NumeroAlbo**

diagram	
namespace	urn:www.agenziaentrate.gov.it:specificheTecniche:sco:730
type	restriction of DatoNP_Type
facets	Kind Value pattern [1-9]{1}[0-9]*
source	<pre> <xs:element name="NumeroAlbo"> <xs:simpleType> <xs:restriction base="cm:DatoNP_Type"> <xs:maxLength value="5"/> </xs:restriction> </xs:simpleType> </xs:element> </pre>

complexType **Dati_Catastali_Recupero_Patrimonio_Edilizio_Type**

diagram	
namespace	urn:www.agenziaentrate.gov.it:specificheTecniche:sco:730
children	m730:NOrdImmobile m730:Condominio m730:CodiceComune m730:TerreniUrbano m730:SezioneUrbanaComuneCatastale m730:Foglio m730:Particella m730:Subalterno
source	<pre> <xs:complexType name="Dati_Catastali_Recupero_Patrimonio_Edilizio_Type"> <xs:sequence> <xs:element name="NOrdImmobile" type="cm:DatoNP_Type"/> <xs:choice> <xs:element name="Condominio" type="cm:DatoCB_Type" minOccurs="0"/> <xs:sequence> <xs:element name="CodiceComune" type="cm:DatoAN_Type" minOccurs="0"/> <xs:element name="TerreniUrbano" type="m730:Terreni_Urbano_Type" minOccurs="0"/> <xs:element name="SezioneUrbanaComuneCatastale" type="cm:DatoAN_Type" minOccurs="0"/> <xs:element name="Foglio" type="cm:DatoAN_Type" minOccurs="0"/> <xs:element name="Particella" minOccurs="0"> <xs:complexType> <xs:sequence minOccurs="0"> <xs:element name="Numeratore" type="cm:DatoAN_Type" minOccurs="0"/> <xs:element name="Denominatore" type="cm:DatoAN_Type" minOccurs="0"/> </xs:sequence> </xs:complexType> </xs:element> <xs:element name="Subalterno" type="cm:DatoAN_Type" minOccurs="0"/> </xs:sequence> </xs:choice> </xs:sequence> </xs:complexType> </pre>

element Dati **Catastali_Recupero_Patrimonio_Edilizio_Type/NOrdImmobile**

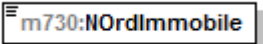
diagram	
namespace	urn:www.agenziaentrate.gov.it:specificheTecniche:sco:730
type	DatoNP_Type
facets	Kind Value pattern [1-9]{1}[0-9]*
source	<xs:element name="NOrdImmobile" type="cm:DatoNP_Type"/>

element Dati **Catastali_Recupero_Patrimonio_Edilizio_Type/Condominio**

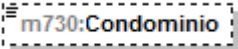
diagram	
namespace	urn:www.agenziaentrate.gov.it:specificheTecniche:sco:730
type	DatoCB_Type
facets	Kind Value pattern [01]
source	<xs:element name="Condominio" type="cm:DatoCB_Type" minOccurs="0"/>

element Dati **Catastali_Recupero_Patrimonio_Edilizio_Type/CodiceComune**

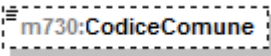
diagram	
namespace	urn:www.agenziaentrate.gov.it:specificheTecniche:sco:730
type	DatoAN_Type
facets	Kind Value pattern (([0-9A-Z-] "){1}([0-9A-Z&] ' - \., /° °\ (\) À È É Ì Ò Ù Ü " \ \\ /+)*
source	<xs:element name="CodiceComune" type="cm:DatoAN_Type" minOccurs="0"/>

element Dati **Catastali_Recupero_Patrimonio_Edilizio_Type/TerreniUrbano**

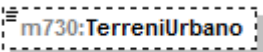
diagram	
namespace	urn:www.agenziaentrate.gov.it:specificheTecniche:sco:730
type	m730:Terreni_Urbano_Type
facets	Kind Value pattern (([0-9A-Z-] "){1}([0-9A-Z&] ' - \., /° °\ (\) À È É Ì Ò Ù Ü " \ \\ /+)* enumeration T enumeration U
source	<xs:element name="TerreniUrbano" type="m730:Terreni_Urbano_Type" minOccurs="0"/>

element Dati **Catastali_Recupero_Patrimonio_Edilizio_Type/SezioneUrbanaComuneCatastale**

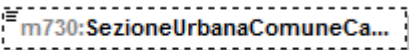
diagram	
namespace	urn:www.agenziaentrate.gov.it:specificheTecniche:sco:730
type	DatoAN_Type

facets	Kind Value pattern ([0-9A-Z-]*)"}{1}([0-9A-Z&:] \\- \\. , / ^\\(\\) À É È Ì Ò Ù Û Ü " \\ \\ \\ +)*
source	<xs:element name="SezioneUrbanaComuneCatastale" type="cm:DatoAN_Type" minOccurs="0"/>

element **Dati Catastali Recupero Patrimonio Edilizio_Type/Foglio**

diagram	
namespace	urn:www.agenziaentrate.gov.it:specificheTecniche:sco:730
type	DatoAN_Type
facets	Kind Value pattern ([0-9A-Z-]*)"}{1}([0-9A-Z&:] \\- \\. , / ^\\(\\) À É È Ì Ò Ù Û Ü " \\ \\ \\ +)*
source	<xs:element name="Foglio" type="cm:DatoAN_Type" minOccurs="0"/>

element **Dati Catastali Recupero Patrimonio Edilizio_Type/Particella**

diagram	
namespace	urn:www.agenziaentrate.gov.it:specificheTecniche:sco:730
children	m730:Numeratore m730:Denominatore
source	<xs:element name="Particella" minOccurs="0"> <xs:complexType> <xs:sequence minOccurs="0"> <xs:element name="Numeratore" type="cm:DatoAN_Type" minOccurs="0"/> <xs:element name="Denominatore" type="cm:DatoAN_Type" minOccurs="0"/> </xs:sequence> </xs:complexType> </xs:element>

element **Dati Catastali Recupero Patrimonio Edilizio_Type/Particella/Numeratore**

diagram	
namespace	urn:www.agenziaentrate.gov.it:specificheTecniche:sco:730
type	DatoAN_Type
facets	Kind Value pattern ([0-9A-Z-]*)"}{1}([0-9A-Z&:] \\- \\. , / ^\\(\\) À É È Ì Ò Ù Û Ü " \\ \\ \\ +)*
source	<xs:element name="Numeratore" type="cm:DatoAN_Type" minOccurs="0"/>

element **Dati Catastali Recupero Patrimonio Edilizio_Type/Particella/Denominatore**

diagram	
namespace	urn:www.agenziaentrate.gov.it:specificheTecniche:sco:730
type	DatoAN_Type
facets	Kind Value pattern ([0-9A-Z-]*)"}{1}([0-9A-Z&:] \\- \\. , / ^\\(\\) À É È Ì Ò Ù Û Ü " \\ \\ \\ +)*
source	<xs:element name="Denominatore" type="cm:DatoAN_Type" minOccurs="0"/>

element **Dati_Catastali_Recupero_Patrimonio_Edilizio_Type/Subalterno**

diagram					
namespace	urn:www.agenziaentrate.gov.it:specificheTecniche:sco:730				
type	DatoAN_Type				
facets	<table border="1"> <thead> <tr> <th>Kind</th> <th>Value</th> </tr> </thead> <tbody> <tr> <td>pattern</td> <td>(([0-9A-Z\-_]\&quot;){1}([0-9A-Z&amp;#x2013;] \\- \\. \\ ° \\^\\(\\)Á É Ë Ì Ò Ú Û &quot; \\ \\ \\+)*</td> </tr> </tbody> </table>	Kind	Value	pattern	(([0-9A-Z\-_]\"){1}([0-9A-Z&#x2013;] \\- \\. \\ ° \\^\\(\\)Á É Ë Ì Ò Ú Û " \\ \\ \\+)*
Kind	Value				
pattern	(([0-9A-Z\-_]\"){1}([0-9A-Z&#x2013;] \\- \\. \\ ° \\^\\(\\)Á É Ë Ì Ò Ú Û " \\ \\ \\+)*				
source	<code><xs:element name="Subalterno" type="cm:DatoAN_Type" minOccurs="0"/></code>				

complexType **Dati_Coniuge_Type**

diagram	
namespace	urn:www.agenziaentrate.gov.it:specificheTecniche:sco:730
children	m730:Tipo m730:CodiceFiscale m730:Mesi
source	<pre> <xs:complexType name="Dati_Coniuge_Type"> <xs:sequence> <xs:element name="Tipo" type="cm:DatoCB_Type"/> <xs:element name="CodiceFiscale" type="cm:DatoCF_Type" minOccurs="0"/> <xs:element name="Mesi" type="m730:Mesi_Type" minOccurs="0"/> </xs:sequence> </xs:complexType> </pre>

element **Dati_Coniuge_Type/Tipo**

diagram					
namespace	urn:www.agenziaentrate.gov.it:specificheTecniche:sco:730				
type	DatoCB_Type				
facets	<table border="1"> <thead> <tr> <th>Kind</th> <th>Value</th> </tr> </thead> <tbody> <tr> <td>pattern</td> <td>[01]</td> </tr> </tbody> </table>	Kind	Value	pattern	[01]
Kind	Value				
pattern	[01]				
source	<code><xs:element name="Tipo" type="cm:DatoCB_Type"/></code>				

element **Dati_Coniuge_Type/CodiceFiscale**

diagram					
namespace	urn:www.agenziaentrate.gov.it:specificheTecniche:sco:730				
type	DatoCF_Type				
facets	<table border="1"> <thead> <tr> <th>Kind</th> <th>Value</th> </tr> </thead> <tbody> <tr> <td>pattern</td> <td>[0-9]{11}[A-Z]{6}[0-9LMNPQRSTUUV]{2}[A-Z]{1}[0-9LMNPQRSTUUV]{2}[A-Z]{1}[0-9LMNPQRSTUUV]{3}[A-Z]{1}</td> </tr> </tbody> </table>	Kind	Value	pattern	[0-9]{11}[A-Z]{6}[0-9LMNPQRSTUUV]{2}[A-Z]{1}[0-9LMNPQRSTUUV]{2}[A-Z]{1}[0-9LMNPQRSTUUV]{3}[A-Z]{1}
Kind	Value				
pattern	[0-9]{11}[A-Z]{6}[0-9LMNPQRSTUUV]{2}[A-Z]{1}[0-9LMNPQRSTUUV]{2}[A-Z]{1}[0-9LMNPQRSTUUV]{3}[A-Z]{1}				
source	<code><xs:element name="CodiceFiscale" type="cm:DatoCF_Type" minOccurs="0"/></code>				

element **Dati_Coniuge_Type/Mesi**

diagram																													
namespace	urn:www.agenziaentrate.gov.it:specificheTecniche:sco:730																												
type	m730:Mesi_Type																												
facets	<table border="1"> <thead> <tr> <th>Kind</th> <th>Value</th> </tr> </thead> <tbody> <tr> <td>pattern</td> <td>[1-9]{1}[0-9]*</td> </tr> <tr> <td>enumeration</td> <td>1</td> </tr> <tr> <td>enumeration</td> <td>2</td> </tr> <tr> <td>enumeration</td> <td>3</td> </tr> <tr> <td>enumeration</td> <td>4</td> </tr> <tr> <td>enumeration</td> <td>5</td> </tr> <tr> <td>enumeration</td> <td>6</td> </tr> <tr> <td>enumeration</td> <td>7</td> </tr> <tr> <td>enumeration</td> <td>8</td> </tr> <tr> <td>enumeration</td> <td>9</td> </tr> <tr> <td>enumeration</td> <td>10</td> </tr> <tr> <td>enumeration</td> <td>11</td> </tr> <tr> <td>enumeration</td> <td>12</td> </tr> </tbody> </table>	Kind	Value	pattern	[1-9]{1}[0-9]*	enumeration	1	enumeration	2	enumeration	3	enumeration	4	enumeration	5	enumeration	6	enumeration	7	enumeration	8	enumeration	9	enumeration	10	enumeration	11	enumeration	12
Kind	Value																												
pattern	[1-9]{1}[0-9]*																												
enumeration	1																												
enumeration	2																												
enumeration	3																												
enumeration	4																												
enumeration	5																												
enumeration	6																												
enumeration	7																												
enumeration	8																												
enumeration	9																												
enumeration	10																												
enumeration	11																												
enumeration	12																												
source	<code><xs:element name="Mesi" type="m730:Mesi_Type" minOccurs="0"/></code>																												

complexType **Dati_Contabili_Type**

diagram	
namespace	urn:www.agenziaentrate.gov.it:specificheTecniche:sco:730
children	m730:Familiari m730:QuadroA m730:QuadroB m730:QuadroC m730:QuadroD m730:QuadroE m730:QuadroF m730:QuadroG m730:QuadroI m730:ProspettoLiquidazione m730:Prospetto Annotazioni
source	<code><xs:complexType name="Dati_Contabili_Type"> <xs:sequence> <xs:element name="Familiari" type="m730:Familiari_Type" minOccurs="0"/> <xs:element name="QuadroA" type="m730:Redditi_Terreni_Type" minOccurs="0"/> <xs:element name="QuadroB" type="m730:Redditi_Fabbricati_Type" minOccurs="0"/> <xs:element name="QuadroC" type="m730:Redditi_Lavoro_Dip_Type" minOccurs="0"/> <xs:element name="QuadroD" minOccurs="0"/></code>

	<pre> <xs:complexType> <xs:complexContent> <xs:extension base="m730:Altri_Reddiiti_Type"/> </xs:complexContent> </xs:complexType> </xs:element> <xs:element name="QuadroE" type="m730:Oneri_Type" minOccurs="0"/> <xs:element name="QuadroF" type="m730:Acconti_Ritenute_Type" minOccurs="0"/> <xs:element name="QuadroG" type="m730:Crediti_Imposta" minOccurs="0"/> <xs:element name="Quadrol" type="m730:Quadro_I_Type" minOccurs="0"/> <xs:element name="ProspettoLiquidazione" type="m730:Prospetto_Liquidazione_Type" minOccurs="0"/> <xs:element name="Prospetto_Annotazioni" type="m730:Prospetto_Annotazioni_Type" minOccurs="0"/> </xs:sequence> </xs:complexType> </pre>
--	---

element **Dati Contabili_Type/Familiari**

diagram	
namespace	urn:www.agenziaentrate.gov.it:specificheTecniche:sco:730
type	m730:Familiari_Type
children	m730:PrimoModulo m730:Modulo
source	<code><xs:element name="Familiari" type="m730:Familiari_Type" minOccurs="0"/></code>

element **Dati Contabili_Type/QuadroA**

diagram	
namespace	urn:www.agenziaentrate.gov.it:specificheTecniche:sco:730
type	m730:Redditi_Terreni_Type
children	m730:Modulo
source	<code><xs:element name="QuadroA" type="m730:Redditi_Terreni_Type" minOccurs="0"/></code>

element **Dati Contabili_Type/QuadroB**

diagram	
namespace	urn:www.agenziaentrate.gov.it:specificheTecniche:sco:730

type	m730:Redditi_Fabbricati_Type
children	m730:Modulo
source	<code><xs:element name="QuadroB" type="m730:Redditi_Fabbricati_Type" minOccurs="0"/></code>

element **Dati Contabili_Type/QuadroC**

diagram	
namespace	urn:www.agenziaentrate.gov.it:specificheTecniche:sco:730
type	m730:Redditi_Lavoro_Dip_Type
children	m730:PrimoModulo m730:Modulo
source	<code><xs:element name="QuadroC" type="m730:Redditi_Lavoro_Dip_Type" minOccurs="0"/></code>

element **Dati Contabili_Type/QuadroD**

diagram	
namespace	urn:www.agenziaentrate.gov.it:specificheTecniche:sco:730
type	extension of m730:Altri_Redditi_Type
children	m730:Modulo
source	<pre> <xs:element name="QuadroD" minOccurs="0"> <xs:complexType> <xs:complexContent> <xs:extension base="m730:Altri_Redditi_Type"/> </xs:complexContent> </xs:complexType> </xs:element> </pre>

element **Dati Contabili_Type/QuadroE**

diagram	
namespace	urn:www.agenziaentrate.gov.it:specificheTecniche:sco:730

type	m730:Oneri_Type
children	m730:PrimoModulo m730:Modulo
source	<code><xs:element name="QuadroE" type="m730:Oneri_Type" minOccurs="0"/></code>

element **Dati Contabili_Type/QuadroF**

diagram	
namespace	urn:www.agenziaentrate.gov.it:specificheTecniche:sco:730
type	m730:Acconti_Ritenute_Type
children	m730:PrimoModulo m730:Modulo
source	<code><xs:element name="QuadroF" type="m730:Acconti_Ritenute_Type" minOccurs="0"/></code>

element **Dati Contabili_Type/QuadroG**

diagram	
namespace	urn:www.agenziaentrate.gov.it:specificheTecniche:sco:730
type	m730:Crediti_Imposta
children	m730:PrimoModulo m730:Modulo
source	<code><xs:element name="QuadroG" type="m730:Crediti_Imposta" minOccurs="0"/></code>

element **Dati Contabili_Type/QuadroI**

diagram	
namespace	urn:www.agenziaentrate.gov.it:specificheTecniche:sco:730
type	m730:Quadro_I_Type
children	m730:Importo m730:Casella
source	<code><xs:element name="QuadroI" type="m730:Quadro_I_Type" minOccurs="0"/></code>

element **Dati Contabili_Type/ProspettoLiquidazione**

diagram	
namespace	urn:www.agenziaentrate.gov.it:specificheTecniche:sco:730
type	m730:Prospetto Liquidazione Type
children	m730:PrimoModulo m730:Modulo
source	<code><xs:element name="ProspettoLiquidazione" type="m730:Prospetto_Liquidazione_Type" minOccurs="0"/></code>

element **Dati Contabili_Type/Prospetto_Anotazioni**

diagram	
namespace	urn:www.agenziaentrate.gov.it:specificheTecniche:sco:730
type	m730:Prospetto Annotazioni Type
children	m730:Modulo_Anotazioni
source	<code><xs:element name="Prospetto_Anotazioni" type="m730:Prospetto_Anotazioni_Type" minOccurs="0"/></code>

complexType **Dati_Contratto_Type**

diagram	
namespace	urn:www.agenziaentrate.gov.it:specificheTecniche:sco:730
children	m730:DataRegContratto m730:SerieContratto m730:NumeroContratto m730:Sottonumero m730:CodiceUfficio
source	<pre> <xs:complexType name="Dati_Contratto_Type"> <xs:sequence> <xs:element name="DataRegContratto" type="cm:DatoDT_Type"/> <xs:element name="SerieContratto" type="m730:Serie_Registrazione_Contratto_Type"/> <xs:element name="NumeroContratto" type="cm:DatoAN_Type"/> <xs:element name="Sottonumero" type="cm:DatoAN_Type" minOccurs="0"/> <xs:element name="CodiceUfficio"/> </xs:sequence> </xs:complexType> </pre>

	<pre> <xs:simpleType> <xs:restriction base="cm:DatoAN_Type"> <xs:length value="3"/> </xs:restriction> </xs:simpleType> </xs:element> </xs:sequence> </xs:complexType> </pre>
--	--

element **Dati_Contratto_Type/DataRegContratto**

diagram					
namespace	urn:www.agenziaentrate.gov.it:specificheTecniche:sco:730				
type	DatoDT_Type				
facets	<table border="1"> <tr> <td>Kind</td> <td>Value</td> </tr> <tr> <td>pattern</td> <td>((([0-9][12][0-9][301])(0[13578][10]12)\d{4}))((([0][1-9][12][0-9][30](0[469][11]\d{4}))((0[1-9][1[0-9]]2[0-8])(02)\d{4})))((29)(02)([02468][048]00))((29)(02)([13579][26]00))((29)(02)([0-9][0][48]))((29)(02)([0-9][2468][048]))((29)(02)([0-9][0-9][13579][26]))))</td> </tr> </table>	Kind	Value	pattern	((([0-9][12][0-9][301])(0[13578][10]12)\d{4}))((([0][1-9][12][0-9][30](0[469][11]\d{4}))((0[1-9][1[0-9]]2[0-8])(02)\d{4})))((29)(02)([02468][048]00))((29)(02)([13579][26]00))((29)(02)([0-9][0][48]))((29)(02)([0-9][2468][048]))((29)(02)([0-9][0-9][13579][26]))))
Kind	Value				
pattern	((([0-9][12][0-9][301])(0[13578][10]12)\d{4}))((([0][1-9][12][0-9][30](0[469][11]\d{4}))((0[1-9][1[0-9]]2[0-8])(02)\d{4})))((29)(02)([02468][048]00))((29)(02)([13579][26]00))((29)(02)([0-9][0][48]))((29)(02)([0-9][2468][048]))((29)(02)([0-9][0-9][13579][26]))))				
source	<code><xs:element name="DataRegContratto" type="cm:DatoDT_Type"/></code>				

element **Dati_Contratto_Type/SerieContratto**

diagram															
namespace	urn:www.agenziaentrate.gov.it:specificheTecniche:sco:730														
type	m730:Serie_Registrazione_Contratto_Type														
facets	<table border="1"> <tr> <td>Kind</td> <td>Value</td> </tr> <tr> <td>pattern</td> <td>(([0-9A-Z]-])&quot;){1}([0-9A-Z&amp;:] ' \"- \". , / ^ ^\(\\)À É Ê Ì Ò Ù Ü &quot; \\ \\ +)*</td> </tr> <tr> <td>enumeration</td> <td>3</td> </tr> <tr> <td>enumeration</td> <td>3A</td> </tr> <tr> <td>enumeration</td> <td>3B</td> </tr> <tr> <td>enumeration</td> <td>3P</td> </tr> <tr> <td>enumeration</td> <td>3T</td> </tr> </table>	Kind	Value	pattern	(([0-9A-Z]-])"){1}([0-9A-Z&:] ' \"- \". , / ^ ^\(\\)À É Ê Ì Ò Ù Ü " \\ \\ +)*	enumeration	3	enumeration	3A	enumeration	3B	enumeration	3P	enumeration	3T
Kind	Value														
pattern	(([0-9A-Z]-])"){1}([0-9A-Z&:] ' \"- \". , / ^ ^\(\\)À É Ê Ì Ò Ù Ü " \\ \\ +)*														
enumeration	3														
enumeration	3A														
enumeration	3B														
enumeration	3P														
enumeration	3T														
source	<code><xs:element name="SerieContratto" type="m730:Serie_Registrazione_Contratto_Type"/></code>														

element **Dati_Contratto_Type/NumeroContratto**

diagram					
namespace	urn:www.agenziaentrate.gov.it:specificheTecniche:sco:730				
type	DatoAN_Type				
facets	<table border="1"> <tr> <td>Kind</td> <td>Value</td> </tr> <tr> <td>pattern</td> <td>(([0-9A-Z]-])&quot;){1}([0-9A-Z&amp;:] ' \"- \". , / ^ ^\(\\)À É Ê Ì Ò Ù Ü &quot; \\ \\ +)*</td> </tr> </table>	Kind	Value	pattern	(([0-9A-Z]-])"){1}([0-9A-Z&:] ' \"- \". , / ^ ^\(\\)À É Ê Ì Ò Ù Ü " \\ \\ +)*
Kind	Value				
pattern	(([0-9A-Z]-])"){1}([0-9A-Z&:] ' \"- \". , / ^ ^\(\\)À É Ê Ì Ò Ù Ü " \\ \\ +)*				
source	<code><xs:element name="NumeroContratto" type="cm:DatoAN_Type"/></code>				

element **Dati_Contratto_Type/Sottonumero**

diagram	
namespace	urn:www.agenziaentrate.gov.it:specificheTecniche:sco:730
type	DatoAN_Type

facets	Kind Value pattern ([0-9A-Z-] \"){1}([0-9A-Z&#39; \" _ . / ^\\(\\) À É Ê Ë Ì Ò Ù Û " \\ \\ \\ +)*
source	<xs:element name="Sottonumero" type="cm:DatoAN_Type" minOccurs="0"/>

element **Dati_Contratto_Type/CodiceUfficio**

diagram	
namespace	urn:www.agenziaentrate.gov.it:specificheTecniche:sco:730
type	restriction of DatoAN_Type
facets	Kind Value pattern ([0-9A-Z-] \"){1}([0-9A-Z&#39; \" _ . / ^\\(\\) À É Ê Ë Ì Ò Ù Û " \\ \\ \\ +)*
source	<xs:element name="CodiceUfficio"> <xs:simpleType> <xs:restriction base="cm:DatoAN_Type"> <xs:length value="3"/> </xs:restriction> </xs:simpleType> </xs:element>

complexType **Dati_Familiare_Type**

diagram	
namespace	urn:www.agenziaentrate.gov.it:specificheTecniche:sco:730
children	m730:CodiceFiscale m730:Mesi m730:MesiMinore m730:PercDetraz m730:PercDetrazCon m730:Affidamento
source	<xs:complexType name="Dati_Familiare_Type"> <xs:sequence> <xs:element name="CodiceFiscale" type="cm:DatoCF_Type" minOccurs="0"/> <xs:element name="Mesi" type="cm:DatoNP_Type"/> <xs:element name="MesiMinore" type="cm:DatoNP_Type" minOccurs="0"/> <xs:choice minOccurs="0"> <xs:element name="PercDetraz" type="cm:DatoPC_Type" minOccurs="0"/> <xs:element name="PercDetrazCon" type="cm:DatoAN_Type" minOccurs="0"/> </xs:choice> <xs:element name="Affidamento" type="cm:DatoCB_Type" minOccurs="0"/> </xs:sequence> </xs:complexType>

element **Dati_Familiare_Type/CodiceFiscale**

diagram	
namespace	urn:www.agenziaentrate.gov.it:specificheTecniche:sco:730

type	DatoCF_Type
facets	Kind Value pattern [0-9]{11}[A-Z]{6}[0-9LMNPQRSTU]{2}[A-Z]{1}[0-9LMNPQRSTU]{2}[A-Z]{1}[0-9LMNPQRSTU]{3}[A-Z]{1}
source	<xs:element name="CodiceFiscale" type="cm:DatoCF_Type" minOccurs="0"/>

element **Dati_Familiare_Type/Mesi**

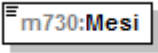
diagram	
namespace	urn:www.agenziaentrate.gov.it:specificheTecniche:sco:730
type	DatoNP_Type
facets	Kind Value pattern [1-9]{1}[0-9]*
source	<xs:element name="Mesi" type="cm:DatoNP_Type"/>

element **Dati_Familiare_Type/MesiMinore**

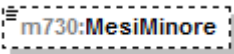
diagram	
namespace	urn:www.agenziaentrate.gov.it:specificheTecniche:sco:730
type	DatoNP_Type
facets	Kind Value pattern [1-9]{1}[0-9]*
source	<xs:element name="MesiMinore" type="cm:DatoNP_Type" minOccurs="0"/>

element **Dati_Familiare_Type/PercDetraz**

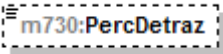
diagram	
namespace	urn:www.agenziaentrate.gov.it:specificheTecniche:sco:730
type	DatoPC_Type
facets	Kind Value pattern [0-9]?[0-9](, \d{1,3})? 100,(0{1,3})?
source	<xs:element name="PercDetraz" type="cm:DatoPC_Type" minOccurs="0"/>

element **Dati_Familiare_Type/PercDetrazCon**

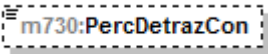
diagram	
namespace	urn:www.agenziaentrate.gov.it:specificheTecniche:sco:730
type	DatoAN_Type
facets	Kind Value pattern ([0-9A-Z-] \"){1}([0-9A-Z&:] [-\., / \^\\(\)\^À È É Ì Ò Ù Ú " \ \\ /+)*
source	<xs:element name="PercDetrazCon" type="cm:DatoAN_Type" minOccurs="0"/>

element **Dati_Familiare_Type/Affidamento**

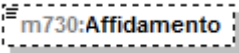
diagram	
---------	---

namespace	urn:www.agenziaentrate.gov.it:specificheTecniche:sco:730
type	DatoCB_Type
facets	Kind Value pattern [01]
source	<xs:element name="Affidamento" type="cm:DatoCB_Type" minOccurs="0"/>

complexType Dati_Nascita_PF_Type

diagram	
namespace	urn:www.agenziaentrate.gov.it:specificheTecniche:sco:730
children	m730:Sesso m730:DataNascita m730:ComuneNascita m730:ProvinciaNascita
source	<pre><xs:complexType name="Dati_Nascita_PF_Type"> <xs:sequence> <xs:element name="Sesso" type="sc:Sesso_Type"/> <xs:element name="DataNascita" type="cm:DatoDT_Type"/> <xs:element name="ComuneNascita" type="cm:DatoAN_Type"/> <xs:element name="ProvinciaNascita" type="cm:PN_Type" minOccurs="0"/> </xs:sequence> </xs:complexType></pre>

element Dati_Nascita_PF_Type/Sesso

diagram	
namespace	urn:www.agenziaentrate.gov.it:specificheTecniche:sco:730
type	Sesso_Type
facets	Kind Value pattern ([0-9A-Z-]]"){1}([0-9A-Z&]] ' \\. / ° °\\(\\) À È É Ì Ò Ù Û " \\ \\ \\ +)* enumeration M enumeration F
source	<xs:element name="Sesso" type="sc:Sesso_Type"/>

element Dati_Nascita_PF_Type/DataNascita

diagram	
namespace	urn:www.agenziaentrate.gov.it:specificheTecniche:sco:730
type	DatoDT_Type
facets	Kind Value pattern (((([0-9][1-9][12][0-9][3][01])(0[13578][10]12)(\\d{4}))) ((([0][1-9][12][0-9][30](0[469][11])(\\d{4}))) ((([0][1-9][1][0-9][2][0-8])(02)(\\d{4}))) ((29)(02)([02468][048]00)) ((29)(02)([13579][26]00)) ((29)(02)([0-9][0-9][0][48])) ((29)(02)([0-9][0-9][2468][048])) ((29)(02)([0-9][0-9][13579][26]))))
source	<xs:element name="DataNascita" type="cm:DatoDT_Type"/>

element **Dati_Nascita_PF_Type/ComuneNascita**

diagram	
namespace	urn:www.agenziaentrate.gov.it:specificheTecniche:sco:730
type	DatoAN_Type
facets	Kind Value pattern ([0-9A-Z-] \"){1}([0-9A-Z&:] ' \- \., / \^\(\\ \\) À É È Ì Ò Ù Ú Û " \\ / +)*
source	<code><xs:element name="ComuneNascita" type="cm:DatoAN_Type"/></code>

element **Dati_Nascita_PF_Type/ProvinciaNascita**

diagram	
namespace	urn:www.agenziaentrate.gov.it:specificheTecniche:sco:730
type	PN_Type
source	<code><xs:element name="ProvinciaNascita" type="cm:PN_Type" minOccurs="0"/></code>

complexType **Dati_Primo_Figlio_Type**

diagram	
namespace	urn:www.agenziaentrate.gov.it:specificheTecniche:sco:730
children	m730:Tipo m730:CodiceFiscale m730:Mesi m730:MesiMinore m730:PercDetraz m730:Affidamento
source	<pre><xs:complexType name="Dati_Primo_Figlio_Type"> <xs:sequence> <xs:element name="Tipo"> <xs:simpleType> <xs:restriction base="cm:DatoAN_Type"> <xs:enumeration value="F"/> <xs:enumeration value="D"/> </xs:restriction> </xs:simpleType> </xs:element> <xs:element name="CodiceFiscale" type="cm:DatoCF_Type" minOccurs="0"/> <xs:element name="Mesi" type="m730:Mesi_Type"/> <xs:element name="MesiMinore" type="m730:Mesi_Type" minOccurs="0"/> <xs:element name="PercDetraz" type="cm:DatoPC_Type" minOccurs="0"/> <xs:element name="Affidamento" type="cm:DatoCB_Type" minOccurs="0"/> </xs:sequence> </xs:complexType></pre>

element **Dati Primo_Figlio_Type/Tipo**

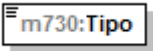
diagram									
namespace	urn:www.agenziaentrate.gov.it:specificheTecniche:sco:730								
type	restriction of DatoAN_Type								
facets	<table border="0"> <tr> <td>Kind</td> <td>Value</td> </tr> <tr> <td>pattern</td> <td>([0-9A-Z-])&quot;){1}([0-9A-Z&amp;:] "- \- . / "° ^\(\\)À È É Ì Ò Ù Ü &quot; \\ \\+)*</td> </tr> <tr> <td>enumeration</td> <td>F</td> </tr> <tr> <td>enumeration</td> <td>D</td> </tr> </table>	Kind	Value	pattern	([0-9A-Z-])"){1}([0-9A-Z&:] "- \- . / "° ^\(\\)À È É Ì Ò Ù Ü " \\ \\+)*	enumeration	F	enumeration	D
Kind	Value								
pattern	([0-9A-Z-])"){1}([0-9A-Z&:] "- \- . / "° ^\(\\)À È É Ì Ò Ù Ü " \\ \\+)*								
enumeration	F								
enumeration	D								
source	<pre><xs:element name="Tipo"> <xs:simpleType> <xs:restriction base="cm:DatoAN_Type"> <xs:enumeration value="F"/> <xs:enumeration value="D"/> </xs:restriction> </xs:simpleType> </xs:element></pre>								

element **Dati Primo_Figlio_Type/CodiceFiscale**

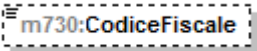
diagram					
namespace	urn:www.agenziaentrate.gov.it:specificheTecniche:sco:730				
type	DatoCF_Type				
facets	<table border="0"> <tr> <td>Kind</td> <td>Value</td> </tr> <tr> <td>pattern</td> <td>[0-9]{11}[A-Z]{6}[0-9LMNPQRSTUUV]{2}[A-Z]{1}[0-9LMNPQRSTUUV]{2}[A-Z]{1}[0-9LMNPQRSTUUV]{3}[A-Z]{1}</td> </tr> </table>	Kind	Value	pattern	[0-9]{11}[A-Z]{6}[0-9LMNPQRSTUUV]{2}[A-Z]{1}[0-9LMNPQRSTUUV]{2}[A-Z]{1}[0-9LMNPQRSTUUV]{3}[A-Z]{1}
Kind	Value				
pattern	[0-9]{11}[A-Z]{6}[0-9LMNPQRSTUUV]{2}[A-Z]{1}[0-9LMNPQRSTUUV]{2}[A-Z]{1}[0-9LMNPQRSTUUV]{3}[A-Z]{1}				
source	<pre><xs:element name="CodiceFiscale" type="cm:DatoCF_Type" minOccurs="0"/></pre>				

element **Dati Primo_Figlio_Type/Mesi**

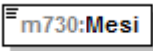
diagram																													
namespace	urn:www.agenziaentrate.gov.it:specificheTecniche:sco:730																												
type	m730:Mesi_Type																												
facets	<table border="0"> <tr> <td>Kind</td> <td>Value</td> </tr> <tr> <td>pattern</td> <td>[1-9]{1}[0-9]*</td> </tr> <tr> <td>enumeration</td> <td>1</td> </tr> <tr> <td>enumeration</td> <td>2</td> </tr> <tr> <td>enumeration</td> <td>3</td> </tr> <tr> <td>enumeration</td> <td>4</td> </tr> <tr> <td>enumeration</td> <td>5</td> </tr> <tr> <td>enumeration</td> <td>6</td> </tr> <tr> <td>enumeration</td> <td>7</td> </tr> <tr> <td>enumeration</td> <td>8</td> </tr> <tr> <td>enumeration</td> <td>9</td> </tr> <tr> <td>enumeration</td> <td>10</td> </tr> <tr> <td>enumeration</td> <td>11</td> </tr> <tr> <td>enumeration</td> <td>12</td> </tr> </table>	Kind	Value	pattern	[1-9]{1}[0-9]*	enumeration	1	enumeration	2	enumeration	3	enumeration	4	enumeration	5	enumeration	6	enumeration	7	enumeration	8	enumeration	9	enumeration	10	enumeration	11	enumeration	12
Kind	Value																												
pattern	[1-9]{1}[0-9]*																												
enumeration	1																												
enumeration	2																												
enumeration	3																												
enumeration	4																												
enumeration	5																												
enumeration	6																												
enumeration	7																												
enumeration	8																												
enumeration	9																												
enumeration	10																												
enumeration	11																												
enumeration	12																												
source	<pre><xs:element name="Mesi" type="m730:Mesi_Type"/></pre>																												

element **Dati Primo_Figlio_Type/MesiMinore**

diagram	
---------	---

namespace	urn:www.agenziaentrate.gov.it:specificheTecniche:sco:730																												
type	m730:Mesi_Type																												
facets	<table border="0"> <thead> <tr> <th>Kind</th> <th>Value</th> </tr> </thead> <tbody> <tr> <td>pattern</td> <td>[1-9]{1}[0-9]*</td> </tr> <tr> <td>enumeration</td> <td>1</td> </tr> <tr> <td>enumeration</td> <td>2</td> </tr> <tr> <td>enumeration</td> <td>3</td> </tr> <tr> <td>enumeration</td> <td>4</td> </tr> <tr> <td>enumeration</td> <td>5</td> </tr> <tr> <td>enumeration</td> <td>6</td> </tr> <tr> <td>enumeration</td> <td>7</td> </tr> <tr> <td>enumeration</td> <td>8</td> </tr> <tr> <td>enumeration</td> <td>9</td> </tr> <tr> <td>enumeration</td> <td>10</td> </tr> <tr> <td>enumeration</td> <td>11</td> </tr> <tr> <td>enumeration</td> <td>12</td> </tr> </tbody> </table>	Kind	Value	pattern	[1-9]{1}[0-9]*	enumeration	1	enumeration	2	enumeration	3	enumeration	4	enumeration	5	enumeration	6	enumeration	7	enumeration	8	enumeration	9	enumeration	10	enumeration	11	enumeration	12
Kind	Value																												
pattern	[1-9]{1}[0-9]*																												
enumeration	1																												
enumeration	2																												
enumeration	3																												
enumeration	4																												
enumeration	5																												
enumeration	6																												
enumeration	7																												
enumeration	8																												
enumeration	9																												
enumeration	10																												
enumeration	11																												
enumeration	12																												
source	<xs:element name="MesiMinore" type="m730:Mesi_Type" minOccurs="0"/>																												

element Dati_Primo_Figlio_Type/PercDetraz

diagram					
namespace	urn:www.agenziaentrate.gov.it:specificheTecniche:sco:730				
type	DatoPC_Type				
facets	<table border="0"> <thead> <tr> <th>Kind</th> <th>Value</th> </tr> </thead> <tbody> <tr> <td>pattern</td> <td>[0-9]?[0-9](,\d{1,3})? 100,0{1,3}?</td> </tr> </tbody> </table>	Kind	Value	pattern	[0-9]?[0-9](,\d{1,3})? 100,0{1,3}?
Kind	Value				
pattern	[0-9]?[0-9](,\d{1,3})? 100,0{1,3}?				
source	<xs:element name="PercDetraz" type="cm:DatoPC_Type" minOccurs="0"/>				

element Dati_Primo_Figlio_Type/Affidamento

diagram					
namespace	urn:www.agenziaentrate.gov.it:specificheTecniche:sco:730				
type	DatoCB_Type				
facets	<table border="0"> <thead> <tr> <th>Kind</th> <th>Value</th> </tr> </thead> <tbody> <tr> <td>pattern</td> <td>[01]</td> </tr> </tbody> </table>	Kind	Value	pattern	[01]
Kind	Value				
pattern	[01]				
source	<xs:element name="Affidamento" type="cm:DatoCB_Type" minOccurs="0"/>				

complexType Dati_Professionista_Type

diagram	
namespace	urn:www.agenziaentrate.gov.it:specificheTecniche:sco:730
children	m730:CFProfessionista m730:CognomeProfessionista m730:NomeProfessionista
source	<pre><xs:complexType name="Dati_Professionista_Type"> <xs:sequence> <xs:element name="CFProfessionista" type="cm:DatoCF_Type"/> <xs:element name="CognomeProfessionista" type="cm:DatoAN_Type"/> <xs:element name="NomeProfessionista" type="cm:DatoAN_Type"/> </xs:sequence> </xs:complexType></pre>

	<pre></xs:sequence> </xs:complexType></pre>
--	---

element **Dati_Professionista_Type/CFProfessionista**

diagram					
namespace	urn:www.agenziaentrate.gov.it:specificheTecniche:sco:730				
type	DatoCF_Type				
facets	<table border="1"> <tr> <td>Kind</td> <td>Value</td> </tr> <tr> <td>pattern</td> <td>[0-9]{11}[A-Z]{6}[0-9LMNPQRSTUVWXYZ]{2}[A-Z]{1}[0-9LMNPQRSTUVWXYZ]{2}[A-Z]{1}[0-9LMNPQRSTUVWXYZ]{3}[A-Z]{1}</td> </tr> </table>	Kind	Value	pattern	[0-9]{11}[A-Z]{6}[0-9LMNPQRSTUVWXYZ]{2}[A-Z]{1}[0-9LMNPQRSTUVWXYZ]{2}[A-Z]{1}[0-9LMNPQRSTUVWXYZ]{3}[A-Z]{1}
Kind	Value				
pattern	[0-9]{11}[A-Z]{6}[0-9LMNPQRSTUVWXYZ]{2}[A-Z]{1}[0-9LMNPQRSTUVWXYZ]{2}[A-Z]{1}[0-9LMNPQRSTUVWXYZ]{3}[A-Z]{1}				
source	<code><xs:element name="CFProfessionista" type="cm:DatoCF_Type"/></code>				

element **Dati_Professionista_Type/CognomeProfessionista**

diagram					
namespace	urn:www.agenziaentrate.gov.it:specificheTecniche:sco:730				
type	DatoAN_Type				
facets	<table border="1"> <tr> <td>Kind</td> <td>Value</td> </tr> <tr> <td>pattern</td> <td>(([0-9A-Z-] \&quot;){1}([0-9A-Z&amp;#39; ! - \., / ° ^\(\)\) À É È Ì Ò Ù Ú &quot; \ \\ / +)*</td> </tr> </table>	Kind	Value	pattern	(([0-9A-Z-] \"){1}([0-9A-Z&#39; ! - \., / ° ^\(\)\) À É È Ì Ò Ù Ú " \ \\ / +)*
Kind	Value				
pattern	(([0-9A-Z-] \"){1}([0-9A-Z&#39; ! - \., / ° ^\(\)\) À É È Ì Ò Ù Ú " \ \\ / +)*				
source	<code><xs:element name="CognomeProfessionista" type="cm:DatoAN_Type"/></code>				

element **Dati_Professionista_Type/NomeProfessionista**

diagram					
namespace	urn:www.agenziaentrate.gov.it:specificheTecniche:sco:730				
type	DatoAN_Type				
facets	<table border="1"> <tr> <td>Kind</td> <td>Value</td> </tr> <tr> <td>pattern</td> <td>(([0-9A-Z-] \&quot;){1}([0-9A-Z&amp;#39; ! - \., / ° ^\(\)\) À É È Ì Ò Ù Ú &quot; \ \\ / +)*</td> </tr> </table>	Kind	Value	pattern	(([0-9A-Z-] \"){1}([0-9A-Z&#39; ! - \., / ° ^\(\)\) À É È Ì Ò Ù Ú " \ \\ / +)*
Kind	Value				
pattern	(([0-9A-Z-] \"){1}([0-9A-Z&#39; ! - \., / ° ^\(\)\) À É È Ì Ò Ù Ú " \ \\ / +)*				
source	<code><xs:element name="NomeProfessionista" type="cm:DatoAN_Type"/></code>				

complexType **Dati_Registrazione_Accatamento_Recupero_Patrimonio_Edilizio_Type**

diagram	
namespace	urn:www.agenziaentrate.gov.it:specificheTecniche:sco:730
children	m730:NOrdImmobile m730:Condominio m730:EstremiRegistrazioneContratto m730:DataDomandaAccatamento

	m730:NumeroDomandaAccatastamento m730:ProvinciaUfficioDomandaAccatastamento
source	<pre><xs:complexType name="Dati_Registrazione_Accatastamento_Recupero_Patrimonio_Edilizio_Type"> <xs:sequence> <xs:element name="NOrdImmobile" type="cm:DatoNP_Type"/> <xs:element name="Condominio" type="cm:DatoCB_Type" minOccurs="0"/> <xs:element name="EstremiRegistrazioneContratto" type="m730:Dati_Contratto_Type" minOccurs="0"/> <xs:element name="DataDomandaAccatastamento" type="cm:DatoDT_Type" minOccurs="0"/> <xs:element name="NumeroDomandaAccatastamento" type="cm:DatoAN_Type" minOccurs="0"/> <xs:element name="ProvinciaUfficioDomandaAccatastamento" type="cm:DatoAN_Type" minOccurs="0"/> </xs:sequence> </xs:complexType></pre>

element **Dati_Registrazione_Accatastamento_Recupero_Patrimonio_Edilizio_Type/NOrdImmobile**

diagram					
namespace	urn:www.agenziaentrate.gov.it:specificheTecniche:sco:730				
type	DatoNP_Type				
facets	<table border="1"> <thead> <tr> <th>Kind</th> <th>Value</th> </tr> </thead> <tbody> <tr> <td>pattern</td> <td>[1-9]{1}[0-9]*</td> </tr> </tbody> </table>	Kind	Value	pattern	[1-9]{1}[0-9]*
Kind	Value				
pattern	[1-9]{1}[0-9]*				
source	<pre><xs:element name="NOrdImmobile" type="cm:DatoNP_Type"/></pre>				

element **Dati_Registrazione_Accatastamento_Recupero_Patrimonio_Edilizio_Type/Condominio**

diagram					
namespace	urn:www.agenziaentrate.gov.it:specificheTecniche:sco:730				
type	DatoCB_Type				
facets	<table border="1"> <thead> <tr> <th>Kind</th> <th>Value</th> </tr> </thead> <tbody> <tr> <td>pattern</td> <td>[01]</td> </tr> </tbody> </table>	Kind	Value	pattern	[01]
Kind	Value				
pattern	[01]				
source	<pre><xs:element name="Condominio" type="cm:DatoCB_Type" minOccurs="0"/></pre>				

element **Dati_Registrazione_Accatastamento_Recupero_Patrimonio_Edilizio_Type/EstremiRegistrazioneContratto**

diagram	
namespace	urn:www.agenziaentrate.gov.it:specificheTecniche:sco:730
type	m730:Dati_Contratto_Type
children	m730:DataRegContratto m730:SerieContratto m730:NumeroContratto m730:Sottonumero m730:CodiceUfficio
source	<pre><xs:element name="EstremiRegistrazioneContratto" type="m730:Dati_Contratto_Type" minOccurs="0"/></pre>

element **Dati_Registrazione_Accatastamento_Recupero_Patrimonio_Edilizio_Type/DataDomandaAccatastamento**

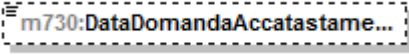
diagram					
namespace	urn:www.agenziaentrate.gov.it:specificheTecniche:sco:730				
type	DatoDT_Type				
facets	<table border="1"> <thead> <tr> <th>Kind</th> <th>Value</th> </tr> </thead> <tbody> <tr> <td>pattern</td> <td>((([0-9]{12} [0-9]{3} 01)([0-9]{13578} 10 12)\d{4}))((([0-9]{1-9} [12][0-9] 30)(0[469] 11)\d{4}))((([0-9]{1-9} [10-9] 2[0-8])(02)\d{4}))((29)(02)([02468][048]00))((29)(02)([13579][26]00))((29)(02)([0-9][0-9][0][48]))((29)(02)([0-9][0-9][2468][048]))((29)(02)([0-9][0-9][13579][26]))))</td> </tr> </tbody> </table>	Kind	Value	pattern	((([0-9]{12} [0-9]{3} 01)([0-9]{13578} 10 12)\d{4}))((([0-9]{1-9} [12][0-9] 30)(0[469] 11)\d{4}))((([0-9]{1-9} [10-9] 2[0-8])(02)\d{4}))((29)(02)([02468][048]00))((29)(02)([13579][26]00))((29)(02)([0-9][0-9][0][48]))((29)(02)([0-9][0-9][2468][048]))((29)(02)([0-9][0-9][13579][26]))))
Kind	Value				
pattern	((([0-9]{12} [0-9]{3} 01)([0-9]{13578} 10 12)\d{4}))((([0-9]{1-9} [12][0-9] 30)(0[469] 11)\d{4}))((([0-9]{1-9} [10-9] 2[0-8])(02)\d{4}))((29)(02)([02468][048]00))((29)(02)([13579][26]00))((29)(02)([0-9][0-9][0][48]))((29)(02)([0-9][0-9][2468][048]))((29)(02)([0-9][0-9][13579][26]))))				
source	<code><xs:element name="DataDomandaAccatastamento" type="cm:DatoDT_Type" minOccurs="0"/></code>				

element **Dati_Registrazione_Accatastamento_Recupero_Patrimonio_Edilizio_Type/NumeroDomandaAccatastamento**

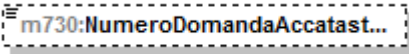
diagram					
namespace	urn:www.agenziaentrate.gov.it:specificheTecniche:sco:730				
type	DatoAN_Type				
facets	<table border="1"> <thead> <tr> <th>Kind</th> <th>Value</th> </tr> </thead> <tbody> <tr> <td>pattern</td> <td>(([0-9A-Z-] \&quot;){1}([0-9A-Z&amp;#39; \-\. , / \^\(\)\ À É È Ì Ò Ù Û &quot; \ \\ +)*</td> </tr> </tbody> </table>	Kind	Value	pattern	(([0-9A-Z-] \"){1}([0-9A-Z&#39; \-\. , / \^\(\)\ À É È Ì Ò Ù Û " \ \\ +)*
Kind	Value				
pattern	(([0-9A-Z-] \"){1}([0-9A-Z&#39; \-\. , / \^\(\)\ À É È Ì Ò Ù Û " \ \\ +)*				
source	<code><xs:element name="NumeroDomandaAccatastamento" type="cm:DatoAN_Type" minOccurs="0"/></code>				

element **Dati_Registrazione_Accatastamento_Recupero_Patrimonio_Edilizio_Type/ProvinciaUfficioDomandaAccatastamento**

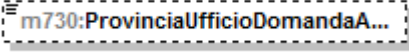
diagram					
namespace	urn:www.agenziaentrate.gov.it:specificheTecniche:sco:730				
type	DatoAN_Type				
facets	<table border="1"> <thead> <tr> <th>Kind</th> <th>Value</th> </tr> </thead> <tbody> <tr> <td>pattern</td> <td>(([0-9A-Z-] \&quot;){1}([0-9A-Z&amp;#39; \-\. , / \^\(\)\ À É È Ì Ò Ù Û &quot; \ \\ +)*</td> </tr> </tbody> </table>	Kind	Value	pattern	(([0-9A-Z-] \"){1}([0-9A-Z&#39; \-\. , / \^\(\)\ À É È Ì Ò Ù Û " \ \\ +)*
Kind	Value				
pattern	(([0-9A-Z-] \"){1}([0-9A-Z&#39; \-\. , / \^\(\)\ À É È Ì Ò Ù Û " \ \\ +)*				
source	<code><xs:element name="ProvinciaUfficioDomandaAccatastamento" type="cm:DatoAN_Type" minOccurs="0"/></code>				

complexType **Dati_Rettificati_Type**

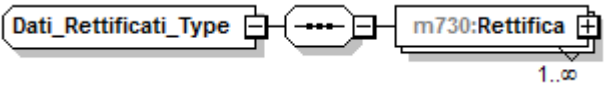
diagram	
namespace	urn:www.agenziaentrate.gov.it:specificheTecniche:sco:730
children	m730:Rettifica
source	<code><xs:complexType name="Dati_Rettificati_Type"> <xs:sequence> <xs:element name="Rettifica" type="m730:Rettifica_Type" maxOccurs="unbounded"/> </xs:sequence> </xs:complexType></code>

element **Dati Rettificati_Type/Rettifica**

diagram	
namespace	urn:www.agenziaentrate.gov.it:specificheTecniche:sco:730
type	m730:Rettifica_Type
children	m730:Quadro m730:Rigo m730:Colonna m730:Modulo m730:DatoRimosso
source	<code><xs:element name="Rettifica" type="m730:Rettifica_Type" maxOccurs="unbounded"/></code>

complexType **Debito_Type**

diagram	
namespace	urn:www.agenziaentrate.gov.it:specificheTecniche:sco:730
children	m730:NonVersare m730:ImportoDaTrattenere
source	<pre> <xs:complexType name="Debito_Type"> <xs:sequence> <xs:element name="NonVersare" type="cm:DatoNP_Type" minOccurs="0"/> <xs:element name="ImportoDaTrattenere" type="cm:DatoNP_Type" minOccurs="0"/> </xs:sequence> </xs:complexType> </pre>

element **Debito_Type/NonVersare**

diagram					
namespace	urn:www.agenziaentrate.gov.it:specificheTecniche:sco:730				
type	DatoNP_Type				
facets	<table border="1"> <thead> <tr> <th>Kind</th> <th>Value</th> </tr> </thead> <tbody> <tr> <td>pattern</td> <td>[1-9]{1}[0-9]*</td> </tr> </tbody> </table>	Kind	Value	pattern	[1-9]{1}[0-9]*
Kind	Value				
pattern	[1-9]{1}[0-9]*				
source	<code><xs:element name="NonVersare" type="cm:DatoNP_Type" minOccurs="0"/></code>				

element **Debito_Type/ImportoDaTrattenere**

diagram	
namespace	urn:www.agenziaentrate.gov.it:specificheTecniche:sco:730

type	DatoNP_Type
facets	Kind Value pattern [1-9]{1}[0-9]*
source	<xs:element name="ImportoDaTrattenere" type="cm:DatoNP_Type" minOccurs="0"/>

complexType **Deduzioni_Modulo_Type**

diagram	
namespace	urn:www.agenziaentrate.gov.it:specificheTecniche:sco:730
children	m730:AssegnoConiuge m730:AltriOneri m730:AcquistoCostruzioneAbitLocazione
source	<xs:complexType name="Deduzioni_Modulo_Type"> <xs:sequence> <xs:element name="AssegnoConiuge" type="m730:Assegno_Coniuge_Type" minOccurs="0"/> <xs:element name="AltriOneri" type="m730:Altri_Oneri_Type" minOccurs="0"/> <xs:element name="AcquistoCostruzioneAbitLocazione" type="m730:Acquisto_Costruzione_Abit_Locazione" minOccurs="0"/> </xs:sequence> </xs:complexType>

element **Deduzioni_Modulo_Type/AssegnoConiuge**

diagram	
namespace	urn:www.agenziaentrate.gov.it:specificheTecniche:sco:730
type	m730:Assegno_Coniuge_Type
children	m730:CodiceFiscale m730:Importo
source	<xs:element name="AssegnoConiuge" type="m730:Assegno_Coniuge_Type" minOccurs="0"/>

element **Deduzioni_Modulo_Type/AltriOneri**

diagram	
namespace	urn:www.agenziaentrate.gov.it:specificheTecniche:sco:730
type	m730:Altri_Oneri_Type
children	m730:Codice m730:Importo

source	<xs:element name="AltriOneri" type="m730:Altri_Oneri_Type" minOccurs="0"/>
--------	--

element **Deduzioni_Modulo_Type/AcquistoCostruzioneAbitLocazione**

diagram	
namespace	urn:www.agenziaentrate.gov.it:specificheTecniche:sco:730
type	m730:Acquisto Costruzione Abit Locazione
children	m730:DataStipula m730:Spesa m730:InteressiMutuo
source	<xs:element name="AcquistoCostruzioneAbitLocazione" type="m730:Acquisto_Costruzione_Abit_Locazione" minOccurs="0"/>

complexType **Deduzioni_Type**

diagram	
namespace	urn:www.agenziaentrate.gov.it:specificheTecniche:sco:730
children	m730:ContributiPrevAss m730:AssegnoConiuge m730:ContributiColf m730:ErogazioniIstituzioniReligiose m730:SpesePortatoriHandicap m730:AltriOneri m730:DeducibilitaOrdinaria m730:LavoratoriPrimaOccupazione m730:FondiInSquilibrioFinanziario m730:FamiliariACarico m730:FondoPensioneDipendentiPubblici m730:AcquistoCostruzioneAbitLocazione

source	<pre> <xs:complexType name="Deduzioni_Type"> <xs:sequence> <xs:element name="ContributiPrevAss" type="cm:DatoNP_Type" minOccurs="0"/> <xs:element name="AssegnoConiuge" type="m730:Assegno_Coniuge_Type" minOccurs="0"/> <xs:element name="ContributiColf" type="cm:DatoNP_Type" minOccurs="0"/> <xs:element name="ErogazioniIstituzioniReligiose" type="cm:DatoNP_Type" minOccurs="0"/> <xs:element name="SpesePortatoriHandicap" type="cm:DatoNP_Type" minOccurs="0"/> <xs:element name="AltriOneri" type="m730:Altri_Oneri_Type" minOccurs="0"/> <xs:element name="DeducibilitaOrdinaria" type="m730:Contributi_Previdenza_Complementare_Type" minOccurs="0"/> <xs:element name="LavoratoriPrimaOccupazione" type="m730:Contributi_Previdenza_Complementare_Type" minOccurs="0"/> <xs:element name="FondiInSquilibrioFinanziario" type="m730:Contributi_Previdenza_Complementare_Type" minOccurs="0"/> <xs:element name="FamiliariACarico" type="m730:Contributi_Previdenza_Complementare_Type" minOccurs="0"/> <xs:element name="FondoPensioneDipendentiPubblici" type="m730:Fondo_Pensione_Dipendenti_Pubblici_Type" minOccurs="0"/> <xs:element name="AcquistoCostruzioneAbitLocazione" type="m730:Acquisto_Costruzione_Abit_Locazione" minOccurs="0"/> </xs:sequence> </xs:complexType> </pre>
--------	---

element **Deduzioni_Type/ContributiPrevAss**

diagram					
namespace	urn:www.agenziaentrate.gov.it:specificheTecniche:sco:730				
type	DatoNP_Type				
facets	<table border="1"> <thead> <tr> <th>Kind</th> <th>Value</th> </tr> </thead> <tbody> <tr> <td>pattern</td> <td>[1-9]{1}[0-9]*</td> </tr> </tbody> </table>	Kind	Value	pattern	[1-9]{1}[0-9]*
Kind	Value				
pattern	[1-9]{1}[0-9]*				
source	<pre><xs:element name="ContributiPrevAss" type="cm:DatoNP_Type" minOccurs="0"/></pre>				

element **Deduzioni_Type/AssegnoConiuge**

diagram	
namespace	urn:www.agenziaentrate.gov.it:specificheTecniche:sco:730
type	m730:Assegno_Coniuge_Type
children	m730:CodiceFiscale m730:Importo
source	<pre><xs:element name="AssegnoConiuge" type="m730:Assegno_Coniuge_Type" minOccurs="0"/></pre>

element **Deduzioni_Type/ContributiColf**

diagram					
namespace	urn:www.agenziaentrate.gov.it:specificheTecniche:sco:730				
type	DatoNP_Type				
facets	<table border="1"> <thead> <tr> <th>Kind</th> <th>Value</th> </tr> </thead> <tbody> <tr> <td>pattern</td> <td>[1-9]{1}[0-9]*</td> </tr> </tbody> </table>	Kind	Value	pattern	[1-9]{1}[0-9]*
Kind	Value				
pattern	[1-9]{1}[0-9]*				
source	<pre><xs:element name="ContributiColf" type="cm:DatoNP_Type" minOccurs="0"/></pre>				

element **Deduzioni_Type/ErogazioniIstituzioniReligiose**

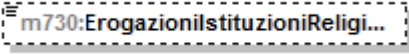
diagram	
namespace	urn:www.agenziaentrate.gov.it:specificheTecniche:sco:730
type	DatoNP_Type
facets	Kind Value pattern [1-9]{1}[0-9]*
source	<code><xs:element name="ErogazioniIstituzioniReligiose" type="cm:DatoNP_Type" minOccurs="0"/></code>

element **Deduzioni_Type/SpesePortatoriHandicap**

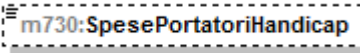
diagram	
namespace	urn:www.agenziaentrate.gov.it:specificheTecniche:sco:730
type	DatoNP_Type
facets	Kind Value pattern [1-9]{1}[0-9]*
source	<code><xs:element name="SpesePortatoriHandicap" type="cm:DatoNP_Type" minOccurs="0"/></code>

element **Deduzioni_Type/AltriOneri**

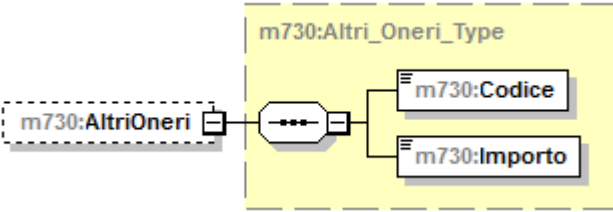
diagram	
namespace	urn:www.agenziaentrate.gov.it:specificheTecniche:sco:730
type	m730:Altri_Oneri_Type
children	m730:Codice m730:Importo
source	<code><xs:element name="AltriOneri" type="m730:Altri_Oneri_Type" minOccurs="0"/></code>

element **Deduzioni_Type/DeducibilitaOrdinaria**

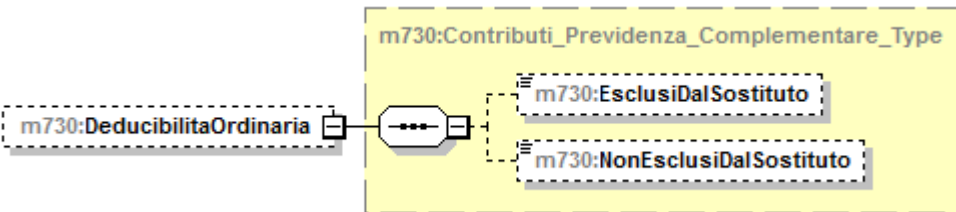
diagram	
namespace	urn:www.agenziaentrate.gov.it:specificheTecniche:sco:730
type	m730:Contributi_Previdenza_Complementare_Type
children	m730:EsclusiDalSostituto m730:NonEsclusiDalSostituto
source	<code><xs:element name="DeducibilitaOrdinaria" type="m730:Contributi_Previdenza_Complementare_Type" minOccurs="0"/></code>

element **Deduzioni_Type/LavoratoriPrimaOccupazione**

diagram	
namespace	urn:www.agenziaentrate.gov.it:specificheTecniche:sco:730
type	m730:Contributi Previdenza Complementare Type
children	m730:EsclusiDalSostituto m730:NonEsclusiDalSostituto
source	<code><xs:element name="LavoratoriPrimaOccupazione" type="m730:Contributi_Previdenza_Complementare_Type" minOccurs="0"/></code>

element **Deduzioni_Type/FondiInSquilibrioFinanziario**

diagram	
namespace	urn:www.agenziaentrate.gov.it:specificheTecniche:sco:730
type	m730:Contributi Previdenza Complementare Type
children	m730:EsclusiDalSostituto m730:NonEsclusiDalSostituto
source	<code><xs:element name="FondiInSquilibrioFinanziario" type="m730:Contributi_Previdenza_Complementare_Type" minOccurs="0"/></code>

element **Deduzioni_Type/FamiliariACarico**

diagram	
namespace	urn:www.agenziaentrate.gov.it:specificheTecniche:sco:730
type	m730:Contributi Previdenza Complementare Type
children	m730:EsclusiDalSostituto m730:NonEsclusiDalSostituto
source	<code><xs:element name="FamiliariACarico" type="m730:Contributi_Previdenza_Complementare_Type" minOccurs="0"/></code>

element **Deduzioni_Type/FondoPensioneDipendentiPubblici**

diagram	
namespace	urn:www.agenziaentrate.gov.it:specificheTecniche:sco:730
type	m730:Fondo_Pensione_Dipendenti_Pubblici_Type
children	m730:Contributi m730:QuotaTFR
source	<code><xs:element name="FondoPensioneDipendentiPubblici" type="m730:Fondo_Pensione_Dipendenti_Pubblici_Type" minOccurs="0"/></code>

element **Deduzioni_Type/AcquistoCostruzioneAbitLocazione**

diagram	
namespace	urn:www.agenziaentrate.gov.it:specificheTecniche:sco:730
type	m730:Acquisto_Costruzione_Abit_Locazione
children	m730:DataStipula m730:Spesa m730:InteressiMutuo
source	<code><xs:element name="AcquistoCostruzioneAbitLocazione" type="m730:Acquisto_Costruzione_Abit_Locazione" minOccurs="0"/></code>

complexType **Detrazione_Crediti_Type**

<p>diagram</p>	
<p>namespace</p>	<p>urn:www.agenziaentrate.gov.it:specificheTecniche:sco:730</p>
<p>children</p>	<p>m730:DetrazioneConiuge m730:DetrazioneFigli m730:UlterioreDetrazioneFigli m730:DetrazioneFamiliari m730:DetrazioneLavDip m730:DetrazionePens m730:DetrazioneAltriRedditi m730:DetrazioneOneri m730:DetrazioneRistrutturazione m730:DetrazioniArredolmmobili m730:DetrazioneRisparmioEnergetico m730:DetrazioneLocEAgricoliGiovani m730:AltreDetrazioni m730:CreditoPrimaCasa m730:CreditoOccupazione m730:CreditoFondiPensione m730:CreditoMediazioni m730:TotaleDetrazioniCrediti</p>
<p>source</p>	<pre><xs:complexType name="Detrazione_Crediti_Type"> <xs:sequence> <xs:element name="DetrazioneConiuge" type="cm:DatoNP_Type" minOccurs="0"/> <xs:element name="DetrazioneFigli" type="cm:DatoNP_Type" minOccurs="0"/> <xs:element name="UlterioreDetrazioneFigli" type="cm:DatoNP_Type" minOccurs="0"/> <xs:element name="DetrazioneFamiliari" type="cm:DatoNP_Type" minOccurs="0"/> <xs:element name="DetrazioneLavDip" type="cm:DatoNP_Type" minOccurs="0"/> <xs:element name="DetrazionePens" type="cm:DatoNP_Type" minOccurs="0"/> <xs:element name="DetrazioneAltriRedditi" type="cm:DatoNP_Type" minOccurs="0"/> <xs:element name="DetrazioneOneri" type="cm:DatoNP_Type" minOccurs="0"/> <xs:element name="DetrazioneRistrutturazione" type="cm:DatoNP_Type" minOccurs="0"/></pre>

	<pre> <xs:element name="DetrazioniArredolImmobili" type="cm:DatoNP_Type" minOccurs="0"/> <xs:element name="DetrazioneRisparmioEnergetico" type="cm:DatoNP_Type" minOccurs="0"/> <xs:element name="DetrazioneLocEAgricoliGiovani" type="cm:DatoNP_Type" minOccurs="0"/> <xs:element name="AltreDetrazioni" type="cm:DatoNP_Type" minOccurs="0"/> <xs:element name="CreditoPrimaCasa" type="cm:DatoNP_Type" minOccurs="0"/> <xs:element name="CreditoOccupazione" type="cm:DatoNP_Type" minOccurs="0"/> <xs:element name="CreditoFondiPensione" type="cm:DatoNP_Type" minOccurs="0"/> <xs:element name="CreditoMediazioni" type="cm:DatoNP_Type" minOccurs="0"/> <xs:element name="TotaleDetrazioniCrediti" type="cm:DatoNP_Type" minOccurs="0"/> </xs:sequence> </xs:complexType> </pre>
--	---

element **Detrazione_Crediti_Type/DetrazioneConiuge**

diagram					
namespace	urn:www.agenziaentrate.gov.it:specificheTecniche:sco:730				
type	DatoNP_Type				
facets	<table border="1"> <tr> <td>Kind</td> <td>Value</td> </tr> <tr> <td>pattern</td> <td>[1-9]{1}[0-9]*</td> </tr> </table>	Kind	Value	pattern	[1-9]{1}[0-9]*
Kind	Value				
pattern	[1-9]{1}[0-9]*				
source	<pre><xs:element name="DetrazioneConiuge" type="cm:DatoNP_Type" minOccurs="0"/></pre>				

element **Detrazione_Crediti_Type/DetrazioneFigli**

diagram					
namespace	urn:www.agenziaentrate.gov.it:specificheTecniche:sco:730				
type	DatoNP_Type				
facets	<table border="1"> <tr> <td>Kind</td> <td>Value</td> </tr> <tr> <td>pattern</td> <td>[1-9]{1}[0-9]*</td> </tr> </table>	Kind	Value	pattern	[1-9]{1}[0-9]*
Kind	Value				
pattern	[1-9]{1}[0-9]*				
source	<pre><xs:element name="DetrazioneFigli" type="cm:DatoNP_Type" minOccurs="0"/></pre>				

element **Detrazione_Crediti_Type/UlterioreDetrazioneFigli**

diagram					
namespace	urn:www.agenziaentrate.gov.it:specificheTecniche:sco:730				
type	DatoNP_Type				
facets	<table border="1"> <tr> <td>Kind</td> <td>Value</td> </tr> <tr> <td>pattern</td> <td>[1-9]{1}[0-9]*</td> </tr> </table>	Kind	Value	pattern	[1-9]{1}[0-9]*
Kind	Value				
pattern	[1-9]{1}[0-9]*				
source	<pre><xs:element name="UlterioreDetrazioneFigli" type="cm:DatoNP_Type" minOccurs="0"/></pre>				

element **Detrazione_Crediti_Type/DetrazioneFamiliari**

diagram					
namespace	urn:www.agenziaentrate.gov.it:specificheTecniche:sco:730				
type	DatoNP_Type				
facets	<table border="1"> <tr> <td>Kind</td> <td>Value</td> </tr> <tr> <td>pattern</td> <td>[1-9]{1}[0-9]*</td> </tr> </table>	Kind	Value	pattern	[1-9]{1}[0-9]*
Kind	Value				
pattern	[1-9]{1}[0-9]*				
source	<pre><xs:element name="DetrazioneFamiliari" type="cm:DatoNP_Type" minOccurs="0"/></pre>				

element **Detrazione_Crediti_Type/DetrazioneLavDip**

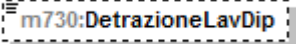
diagram	
namespace	urn:www.agenziaentrate.gov.it:specificheTecniche:sco:730
type	DatoNP_Type
facets	Kind Value pattern [1-9]{1}[0-9]*
source	<xs:element name="DetrazioneLavDip" type="cm:DatoNP_Type" minOccurs="0"/>

element **Detrazione_Crediti_Type/DetrazionePens**

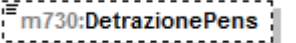
diagram	
namespace	urn:www.agenziaentrate.gov.it:specificheTecniche:sco:730
type	DatoNP_Type
facets	Kind Value pattern [1-9]{1}[0-9]*
source	<xs:element name="DetrazionePens" type="cm:DatoNP_Type" minOccurs="0"/>

element **Detrazione_Crediti_Type/DetrazioneAltriRedditi**

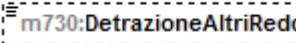
diagram	
namespace	urn:www.agenziaentrate.gov.it:specificheTecniche:sco:730
type	DatoNP_Type
facets	Kind Value pattern [1-9]{1}[0-9]*
source	<xs:element name="DetrazioneAltriRedditi" type="cm:DatoNP_Type" minOccurs="0"/>

element **Detrazione_Crediti_Type/DetrazioneOneri**

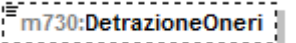
diagram	
namespace	urn:www.agenziaentrate.gov.it:specificheTecniche:sco:730
type	DatoNP_Type
facets	Kind Value pattern [1-9]{1}[0-9]*
source	<xs:element name="DetrazioneOneri" type="cm:DatoNP_Type" minOccurs="0"/>

element **Detrazione_Crediti_Type/DetrazioneRistrutturazione**

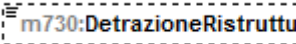
diagram	
namespace	urn:www.agenziaentrate.gov.it:specificheTecniche:sco:730
type	DatoNP_Type
facets	Kind Value pattern [1-9]{1}[0-9]*

source	<xs:element name="DetrazioneRistrutturazione" type="cm:DatoNP_Type" minOccurs="0"/>
--------	---

element **Detrazione_Crediti_Type/DetrazioniArredolmmobili**

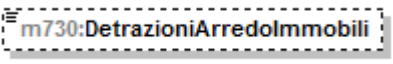
diagram					
namespace	urn:www.agenziaentrate.gov.it:specificheTecniche:sco:730				
type	DatoNP_Type				
facets	<table border="1"> <tr> <td>Kind</td> <td>Value</td> </tr> <tr> <td>pattern</td> <td>[1-9]{1}[0-9]*</td> </tr> </table>	Kind	Value	pattern	[1-9]{1}[0-9]*
Kind	Value				
pattern	[1-9]{1}[0-9]*				
source	<xs:element name="DetrazioniArredolmmobili" type="cm:DatoNP_Type" minOccurs="0"/>				

element **Detrazione_Crediti_Type/DetrazioneRisparmioEnergetico**

diagram					
namespace	urn:www.agenziaentrate.gov.it:specificheTecniche:sco:730				
type	DatoNP_Type				
facets	<table border="1"> <tr> <td>Kind</td> <td>Value</td> </tr> <tr> <td>pattern</td> <td>[1-9]{1}[0-9]*</td> </tr> </table>	Kind	Value	pattern	[1-9]{1}[0-9]*
Kind	Value				
pattern	[1-9]{1}[0-9]*				
source	<xs:element name="DetrazioneRisparmioEnergetico" type="cm:DatoNP_Type" minOccurs="0"/>				

element **Detrazione_Crediti_Type/DetrazioneLocEAgricoliGiovani**

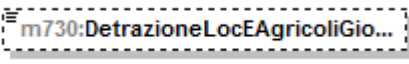
diagram					
namespace	urn:www.agenziaentrate.gov.it:specificheTecniche:sco:730				
type	DatoNP_Type				
facets	<table border="1"> <tr> <td>Kind</td> <td>Value</td> </tr> <tr> <td>pattern</td> <td>[1-9]{1}[0-9]*</td> </tr> </table>	Kind	Value	pattern	[1-9]{1}[0-9]*
Kind	Value				
pattern	[1-9]{1}[0-9]*				
source	<xs:element name="DetrazioneLocEAgricoliGiovani" type="cm:DatoNP_Type" minOccurs="0"/>				

element **Detrazione_Crediti_Type/AltreDetrazioni**

diagram					
namespace	urn:www.agenziaentrate.gov.it:specificheTecniche:sco:730				
type	DatoNP_Type				
facets	<table border="1"> <tr> <td>Kind</td> <td>Value</td> </tr> <tr> <td>pattern</td> <td>[1-9]{1}[0-9]*</td> </tr> </table>	Kind	Value	pattern	[1-9]{1}[0-9]*
Kind	Value				
pattern	[1-9]{1}[0-9]*				
source	<xs:element name="AltreDetrazioni" type="cm:DatoNP_Type" minOccurs="0"/>				

element **Detrazione_Crediti_Type/CreditoPrimaCasa**

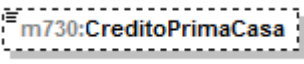
diagram	
namespace	urn:www.agenziaentrate.gov.it:specificheTecniche:sco:730
type	DatoNP_Type

facets	Kind Value pattern [1-9]{1}[0-9]*
source	<xs:element name="CreditoPrimaCasa" type="cm:DatoNP_Type" minOccurs="0"/>

element **Detrazione_Crediti_Type/CreditoOccupazione**

diagram	
namespace	urn:www.agenziaentrate.gov.it:specificheTecniche:sco:730
type	DatoNP_Type
facets	Kind Value pattern [1-9]{1}[0-9]*
source	<xs:element name="CreditoOccupazione" type="cm:DatoNP_Type" minOccurs="0"/>

element **Detrazione_Crediti_Type/CreditoFondiPensione**

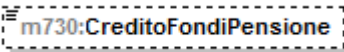
diagram	
namespace	urn:www.agenziaentrate.gov.it:specificheTecniche:sco:730
type	DatoNP_Type
facets	Kind Value pattern [1-9]{1}[0-9]*
source	<xs:element name="CreditoFondiPensione" type="cm:DatoNP_Type" minOccurs="0"/>

element **Detrazione_Crediti_Type/CreditoMediazioni**

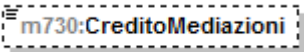
diagram	
namespace	urn:www.agenziaentrate.gov.it:specificheTecniche:sco:730
type	DatoNP_Type
facets	Kind Value pattern [1-9]{1}[0-9]*
source	<xs:element name="CreditoMediazioni" type="cm:DatoNP_Type" minOccurs="0"/>

element **Detrazione_Crediti_Type/TotaleDetrazioniCrediti**

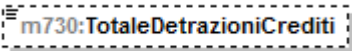
diagram	
namespace	urn:www.agenziaentrate.gov.it:specificheTecniche:sco:730
type	DatoNP_Type
facets	Kind Value pattern [1-9]{1}[0-9]*
source	<xs:element name="TotaleDetrazioniCrediti" type="cm:DatoNP_Type" minOccurs="0"/>

complexType **Detrazioni_Canoni_Locazione_Type**

diagram	
namespace	urn:www.agenziaentrate.gov.it:specificheTecniche:sco:730
children	m730:InquiliniAbitazionePrincipale m730:DipendentiTrasferiti
source	<pre><xs:complexType name="Detrazioni_Canoni_Locazione_Type"> <xs:sequence> <xs:element name="InquiliniAbitazionePrincipale" type="m730:Inquilini_Abitazione_Principale_Type" minOccurs="0"/> <xs:element name="DipendentiTrasferiti" type="m730:Giorni_Percentuale_Type" minOccurs="0"/> </xs:sequence> </xs:complexType></pre>

element **Detrazioni_Canoni_Locazione_Type/InquiliniAbitazionePrincipale**

diagram	
namespace	urn:www.agenziaentrate.gov.it:specificheTecniche:sco:730
type	m730:Inquilini_Abitazione_Principale_Type
children	m730:Tipologia m730:GiorniPercentuale
source	<pre><xs:element name="InquiliniAbitazionePrincipale" type="m730:Inquilini_Abitazione_Principale_Type" minOccurs="0"/></pre>

element **Detrazioni_Canoni_Locazione_Type/DipendentiTrasferiti**

diagram	
namespace	urn:www.agenziaentrate.gov.it:specificheTecniche:sco:730
type	m730:Giorni_Percentuale_Type
children	m730:Giorni m730:Percentuale
source	<pre><xs:element name="DipendentiTrasferiti" type="m730:Giorni_Percentuale_Type" minOccurs="0"/></pre>

complexType **Detrazioni_Modulo_Type**

diagram	
namespace	urn:www.agenziaentrate.gov.it:specificheTecniche:sco:730
children	m730:VeicoliDisabili m730:AcquistoCaniGuida m730:SpeseRateizzate m730:AltreSpese
source	<pre><xs:complexType name="Detrazioni_Modulo_Type"> <xs:sequence> <xs:element name="VeicoliDisabili" type="m730:Spese_Rateizzate_Type" minOccurs="0"/> <xs:element name="AcquistoCaniGuida" type="m730:Spese_Rateizzate_Type" minOccurs="0"/> <xs:element name="SpeseRateizzate" type="m730:Spese_Rateizzate_Anni_Precedenti_Type" minOccurs="0"/> <xs:element name="AltreSpese" type="m730:Altre_Spese_Type" minOccurs="0" maxOccurs="5"/> </xs:sequence> </xs:complexType></pre>

element **Detrazioni_Modulo_Type/VeicoliDisabili**

diagram	
namespace	urn:www.agenziaentrate.gov.it:specificheTecniche:sco:730
type	m730:Spese_Rateizzate_Type
children	m730:Codice m730:Importo
source	<pre><xs:element name="VeicoliDisabili" type="m730:Spese_Rateizzate_Type" minOccurs="0"/></pre>

element **Detrazioni_Modulo_Type/AcquistoCaniGuida**

diagram	
namespace	urn:www.agenziaentrate.gov.it:specificheTecniche:sco:730
type	m730:Spese_Rateizzate_Type
children	m730:Codice m730:Importo
source	<pre><xs:element name="AcquistoCaniGuida" type="m730:Spese_Rateizzate_Type" minOccurs="0"/></pre>

element **Detrazioni_Modulo_Type/SpeseRateizzate**

diagram	
namespace	urn:www.agenziaentrate.gov.it:specificheTecniche:sco:730
type	m730:Spese_Rateizzate_Anni_Precedenti_Type
children	m730:Codice m730:Importo
source	<code><xs:element name="SpeseRateizzate" type="m730:Spese_Rateizzate_Anni_Precedenti_Type" minOccurs="0"/></code>

element **Detrazioni_Modulo_Type/AltreSpese**

diagram	
namespace	urn:www.agenziaentrate.gov.it:specificheTecniche:sco:730
type	m730:Altre_Spese_Type
children	m730:Codice m730:Importo
source	<code><xs:element name="AltreSpese" type="m730:Altre_Spese_Type" minOccurs="0" maxOccurs="5"/></code>

complexType **Detrazioni_Type**

diagram	
namespace	urn:www.agenziaentrate.gov.it:specificheTecniche:sco:730
children	m730:CasellaRateazione m730:SpeseDeterminatePatologie m730:SpeseSanitarie m730:SpeseFamNonACarico m730:SpeseSanitarieDisabili m730:VeicoliDisabili m730:AcquistoCaniGuida m730:SpeseRateizzate m730:MutuiAbPrincipale m730:AltreSpese
source	<pre> <xs:complexType name="Detrazioni_Type"> <xs:sequence> <xs:element name="CasellaRateazione" type="cm:DatoCB_Type" minOccurs="0"/> <xs:element name="SpeseDeterminatePatologie" type="cm:DatoNP_Type" minOccurs="0"/> <xs:element name="SpeseSanitarie" type="cm:DatoNP_Type" minOccurs="0"/> <xs:element name="SpeseFamNonACarico" type="cm:DatoNP_Type" minOccurs="0"/> <xs:element name="SpeseSanitarieDisabili" type="cm:DatoNP_Type" minOccurs="0"/> <xs:element name="VeicoliDisabili" type="m730:Spese_Rateizzate_Type" minOccurs="0"/> <xs:element name="AcquistoCaniGuida" type="m730:Spese_Rateizzate_Type" minOccurs="0"/> <xs:element name="SpeseRateizzate" type="m730:Spese_Rateizzate_Anni_Precedenti_Type" minOccurs="0"/> <xs:element name="MutuiAbPrincipale" type="cm:DatoNP_Type" minOccurs="0"/> <xs:element name="AltreSpese" type="m730:Altre_Spese_Type" minOccurs="0" maxOccurs="5"/> </xs:sequence> </xs:complexType> </pre>

element **Detrazioni_Type/CasellaRateazione**

diagram					
namespace	urn:www.agenziaentrate.gov.it:specificheTecniche:sco:730				
type	DatoCB_Type				
facets	<table border="1"> <thead> <tr> <th>Kind</th> <th>Value</th> </tr> </thead> <tbody> <tr> <td>pattern</td> <td>[01]</td> </tr> </tbody> </table>	Kind	Value	pattern	[01]
Kind	Value				
pattern	[01]				
source	<pre><xs:element name="CasellaRateazione" type="cm:DatoCB_Type" minOccurs="0"/></pre>				

element **Detrazioni_Type/SpeseDeterminatePatologie**

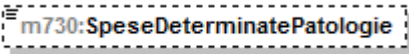
diagram	
namespace	urn:www.agenziaentrate.gov.it:specificheTecniche:sco:730
type	DatoNP_Type
facets	Kind Value pattern [1-9]{1}[0-9]*
source	<xs:element name="SpeseDeterminatePatologie" type="cm:DatoNP_Type" minOccurs="0"/>

element **Detrazioni_Type/SpeseSanitarie**

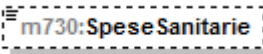
diagram	
namespace	urn:www.agenziaentrate.gov.it:specificheTecniche:sco:730
type	DatoNP_Type
facets	Kind Value pattern [1-9]{1}[0-9]*
source	<xs:element name="SpeseSanitarie" type="cm:DatoNP_Type" minOccurs="0"/>

element **Detrazioni_Type/SpeseFamNonACarico**

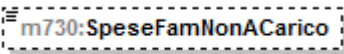
diagram	
namespace	urn:www.agenziaentrate.gov.it:specificheTecniche:sco:730
type	DatoNP_Type
facets	Kind Value pattern [1-9]{1}[0-9]*
source	<xs:element name="SpeseFamNonACarico" type="cm:DatoNP_Type" minOccurs="0"/>

element **Detrazioni_Type/SpeseSanitarieDisabili**

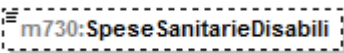
diagram	
namespace	urn:www.agenziaentrate.gov.it:specificheTecniche:sco:730
type	DatoNP_Type
facets	Kind Value pattern [1-9]{1}[0-9]*
source	<xs:element name="SpeseSanitarieDisabili" type="cm:DatoNP_Type" minOccurs="0"/>

element **Detrazioni_Type/VeicoliDisabili**

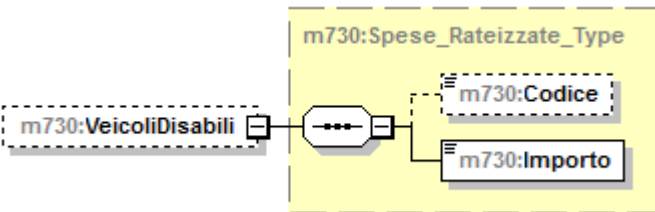
diagram	
---------	---

namespace	urn:www.agenziaentrate.gov.it:specificheTecniche:sco:730
type	m730:Spese_Rateizzate_Type
children	m730:Codice m730:Importo
source	<xs:element name="VeicoliDisabili" type="m730:Spese_Rateizzate_Type" minOccurs="0"/>

element **Detrazioni_Type/AcquistoCaniGuida**

diagram	
namespace	urn:www.agenziaentrate.gov.it:specificheTecniche:sco:730
type	m730:Spese_Rateizzate_Type
children	m730:Codice m730:Importo
source	<xs:element name="AcquistoCaniGuida" type="m730:Spese_Rateizzate_Type" minOccurs="0"/>

element **Detrazioni_Type/SpeseRateizzate**

diagram	
namespace	urn:www.agenziaentrate.gov.it:specificheTecniche:sco:730
type	m730:Spese_Rateizzate_Anni_Precedenti_Type
children	m730:Codice m730:Importo
source	<xs:element name="SpeseRateizzate" type="m730:Spese_Rateizzate_Anni_Precedenti_Type" minOccurs="0"/>

element **Detrazioni_Type/MutuiAbPrincipale**

diagram					
namespace	urn:www.agenziaentrate.gov.it:specificheTecniche:sco:730				
type	DatoNP_Type				
facets	<table border="1"> <thead> <tr> <th>Kind</th> <th>Value</th> </tr> </thead> <tbody> <tr> <td>pattern</td> <td>[1-9]{1}[0-9]*</td> </tr> </tbody> </table>	Kind	Value	pattern	[1-9]{1}[0-9]*
Kind	Value				
pattern	[1-9]{1}[0-9]*				
source	<xs:element name="MutuiAbPrincipale" type="cm:DatoNP_Type" minOccurs="0"/>				

element **Detrazioni_Type/AltreSpese**

diagram	
namespace	urn:www.agenziaentrate.gov.it:specificheTecniche:sco:730
type	m730:Altre_Spese_Type
children	m730:Codice m730:Importo
source	<code><xs:element name="AltreSpese" type="m730:Altre_Spese_Type" minOccurs="0" maxOccurs="5"/></code>

complexType **Dich_Non_Precompilata**

diagram	
namespace	urn:www.agenziaentrate.gov.it:specificheTecniche:sco:730
children	m730:PrecompNonPresente m730:SostCafProfessNonDelegato
source	<pre> <xs:complexType name="Dich_Non_Precompilata"> <xs:sequence> <xs:element name="PrecompNonPresente" type="cm:DatoCB_Type" minOccurs="0"/> <xs:element name="SostCafProfessNonDelegato" type="cm:DatoCB_Type" minOccurs="0"/> </xs:sequence> </xs:complexType> </pre>

element **Dich_Non_Precompilata/PrecompNonPresente**

diagram					
namespace	urn:www.agenziaentrate.gov.it:specificheTecniche:sco:730				
type	DatoCB_Type				
facets	<table border="1"> <tr> <td>Kind</td> <td>Value</td> </tr> <tr> <td>pattern</td> <td>[01]</td> </tr> </table>	Kind	Value	pattern	[01]
Kind	Value				
pattern	[01]				
source	<code><xs:element name="PrecompNonPresente" type="cm:DatoCB_Type" minOccurs="0"/></code>				

element **Dich_Non_Precompilata/SostCafProfessNonDelegato**

diagram					
namespace	urn:www.agenziaentrate.gov.it:specificheTecniche:sco:730				
type	DatoCB_Type				
facets	<table border="1"> <tr> <td>Kind</td> <td>Value</td> </tr> <tr> <td>pattern</td> <td>[01]</td> </tr> </table>	Kind	Value	pattern	[01]
Kind	Value				
pattern	[01]				
source	<code><xs:element name="SostCafProfessNonDelegato" type="cm:DatoCB_Type" minOccurs="0"/></code>				

complexType **Dich_Precompilata_Type**

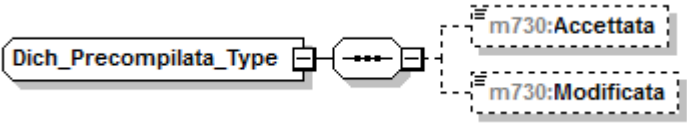
diagram	
namespace	urn:www.agenziaentrate.gov.it:specificheTecniche:sco:730
children	m730:Accettata m730:Modificata
source	<pre><xs:complexType name="Dich_Precompilata_Type"> <xs:sequence> <xs:element name="Accettata" type="cm:DatoCB_Type" minOccurs="0"/> <xs:element name="Modificata" type="cm:DatoCB_Type" minOccurs="0"/> </xs:sequence> </xs:complexType></pre>

element **Dich_Precompilata_Type/Accettata**

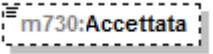
diagram	
namespace	urn:www.agenziaentrate.gov.it:specificheTecniche:sco:730
type	DatoCB_Type
facets	Kind Value pattern [01]
source	<pre><xs:element name="Accettata" type="cm:DatoCB_Type" minOccurs="0"/></pre>

element **Dich_Precompilata_Type/Modificata**

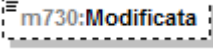
diagram	
namespace	urn:www.agenziaentrate.gov.it:specificheTecniche:sco:730
type	DatoCB_Type
facets	Kind Value pattern [01]
source	<pre><xs:element name="Modificata" type="cm:DatoCB_Type" minOccurs="0"/></pre>

complexType **Dichiarazione_Con_Type**

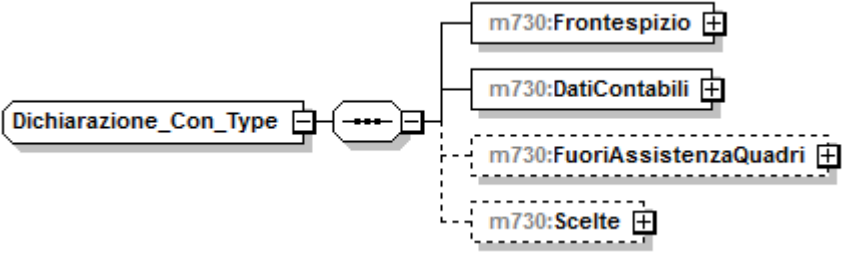
diagram	
namespace	urn:www.agenziaentrate.gov.it:specificheTecniche:sco:730
children	m730:Frontespizio m730:DatiContabili m730:FuoriAssistenzaQuadri m730:Scelte
source	<pre><xs:complexType name="Dichiarazione_Con_Type"> <xs:sequence> <xs:element name="Frontespizio" type="m730:Frontespizio_Con_Type"/> <xs:element name="DatiContabili" type="m730:Dati_Constabili_Type"/> </xs:sequence> </xs:complexType></pre>

```

<xs:element name="FuoriAssistenzaQuadri" type="m730:Fuori_Assistenza_Type" minOccurs="0"/>
<xs:element name="Scelte" type="sce:Scelte_Type" minOccurs="0"/>
</xs:sequence>
</xs:complexType>

```

element **Dichiarazione_Con_Type/Frontespizio**

<p>diagram</p>	
<p>namespace</p>	<p>urn:www.agenziaentrate.gov.it:specificheTecniche:sco:730</p>
<p>type</p>	<p>m730:Frontespizio_Con_Type</p>
<p>children</p>	<p>m730:SoggettoFiscale m730:DatiAnagrafici m730:StatoCivile m730:ResidenzaAnagrafica m730:DomicilioFiscale01012014 m730:DomicilioFiscale01012015 m730:CasiParticolariAddizionale m730:Firma</p>
<p>source</p>	<p><xs:element name="Frontespizio" type="m730:Frontespizio_Con_Type"/></p>

element **Dichiarazione_Con_Type/DatiContabili**

<p>diagram</p>	
<p>namespace</p>	<p>urn:www.agenziaentrate.gov.it:specificheTecniche:sco:730</p>
<p>type</p>	<p>m730:Dati_Contabili_Type</p>
<p>children</p>	<p>m730:Familiari m730:QuadroA m730:QuadroB m730:QuadroC m730:QuadroD m730:QuadroE m730:QuadroF m730:QuadroG m730:QuadroI m730:ProspettoLiquidazione m730:Prospetto_Anotazioni</p>
<p>source</p>	<p><xs:element name="DatiContabili" type="m730:Dati_Contabili_Type"/></p>

element **Dichiarazione_Con_Type/FuoriAssistenzaQuadri**

<p>diagram</p>	
<p>namespace</p>	<p>urn:www.agenziaentrate.gov.it:specificheTecniche:sco:730</p>

type	m730:Fuori_Assistenza_Type
children	m730:AnomaliaDatianagrafici m730:AnomaliaTerreni m730:AnomaliaFabbricati m730:AnomaliaLavDip m730:AnomaliaAltriRedditi m730:AnomaliaQuadroF
source	<xs:element name="FuoriAssistenzaQuadri" type="m730:Fuori_Assistenza_Type" minOccurs="0"/>

element Dichiarazione_Con_Type/Scelte

diagram	
namespace	urn:www.agenziaentrate.gov.it:specificheTecniche:sco:730
type	sce:Scelte_Type
children	sce:Scelta5PerMille sce:Scelta8PerMille sce:Scelta2PerMille
source	<xs:element name="Scelte" type="sce:Scelte_Type" minOccurs="0"/>

complexType Dichiarazione_Dich_Type

diagram	
namespace	urn:www.agenziaentrate.gov.it:specificheTecniche:sco:730
children	m730:Frontespizio m730:DatiContabili m730:FuoriAssistenza m730:Scelte
source	<pre> <xs:complexType name="Dichiarazione_Dich_Type"> <xs:sequence> <xs:element name="Frontespizio"> <xs:complexType> <xs:complexContent> <xs:extension base="m730:Frontespizio_Dich_Type"/> </xs:complexContent> </xs:complexType> </xs:element> <xs:element name="DatiContabili" type="m730:Dati_Contabili_Type"/> <xs:element name="FuoriAssistenza" minOccurs="0"> <xs:complexType> <xs:sequence> <xs:element name="FuoriAssistenzaQuadri" type="m730:Fuori_Assistenza_Type" minOccurs="0"/> <xs:element name="AnomaliaDatiSostituto" type="cm:DatoCB_Type" minOccurs="0"/> <xs:element name="AnomaliaDatiRappresentante" type="cm:DatoCB_Type" minOccurs="0"/> </xs:sequence> </xs:complexType> </xs:element> <xs:element name="Scelte" type="sce:Scelte_Type" minOccurs="0"/> </xs:sequence> </xs:complexType> </pre>

</xs:complexType>

element **Dichiarazione Dich_Type/Frontespizio**

diagram	<p>The diagram illustrates the structure of the <code>m730:Frontespizio_Dich_Type</code> (extension) element. It is a complex type that extends <code>m730:Frontespizio Dich_Type</code>. The structure includes the following elements:</p> <ul style="list-style-type: none"><code>m730:SoggettoFiscale</code> (required, one)<code>m730:DatiAnagrafici</code> (required, one)<code>m730:StatoCivile</code> (optional, one)<code>m730:ResidenzaAnagrafica</code> (optional, one)<code>m730:DomicilioFiscale01012014</code> (optional, one)<code>m730:DomicilioFiscale01012015</code> (optional, one)<code>m730:CasiParticolariAddizionale</code> (optional, one)<code>m730:Firma</code> (optional, one)<code>m730:Rappresentante</code> (optional, one)
namespace	urn:www.agenziaentrate.gov.it:specificheTecniche:sco:730
type	extension of m730:Frontespizio Dich_Type
children	m730:SoggettoFiscale m730:DatiAnagrafici m730:StatoCivile m730:ResidenzaAnagrafica m730:DomicilioFiscale01012014 m730:DomicilioFiscale01012015 m730:CasiParticolariAddizionale m730:Firma m730:Rappresentante
source	<pre><xs:element name="Frontespizio"> <xs:complexType> <xs:complexContent> <xs:extension base="m730:Frontespizio_Dich_Type"/> </xs:complexContent> </xs:complexType> </xs:element></pre>

element **Dichiarazione_Dich_Type/DatiContabili**

diagram	
namespace	urn:www.agenziaentrate.gov.it:specificheTecniche:sco:730
type	m730:Dati_Contabili_Type
children	m730:Familiari m730:QuadroA m730:QuadroB m730:QuadroC m730:QuadroD m730:QuadroE m730:QuadroF m730:QuadroG m730:QuadroI m730:ProspettoLiquidazione m730:Prospetto_Anotazioni
source	<code><xs:element name="DatiContabili" type="m730:Dati_Contabili_Type"/></code>

element **Dichiarazione_Dich_Type/FuoriAssistenza**

diagram	
namespace	urn:www.agenziaentrate.gov.it:specificheTecniche:sco:730
children	m730:FuoriAssistenzaQuadri m730:AnomaliaDatiSostituto m730:AnomaliaDatiRappresentante
source	<pre> <xs:element name="FuoriAssistenza" minOccurs="0"> <xs:complexType> <xs:sequence> <xs:element name="FuoriAssistenzaQuadri" type="m730:Fuori_Assistenza_Type" minOccurs="0"/> <xs:element name="AnomaliaDatiSostituto" type="cm:DatoCB_Type" minOccurs="0"/> <xs:element name="AnomaliaDatiRappresentante" type="cm:DatoCB_Type" minOccurs="0"/> </xs:sequence> </xs:complexType> </xs:element> </pre>

element **Dichiarazione_Dich_Type/FuoriAssistenza/FuoriAssistenzaQuadri**

diagram	
namespace	urn:www.agenziaentrate.gov.it:specificheTecniche:sco:730
type	m730:Fuori_Assistenza_Type
children	m730:AnomaliaDatianagrafici m730:AnomaliaTerreni m730:AnomaliaFabbricati m730:AnomaliaLavDip m730:AnomaliaAltriRedditi m730:AnomaliaQuadroF
source	<xs:element name="FuoriAssistenzaQuadri" type="m730:Fuori_Assistenza_Type" minOccurs="0"/>

element **Dichiarazione_Dich_Type/FuoriAssistenza/AnomaliaDatiSostituto**

diagram	
namespace	urn:www.agenziaentrate.gov.it:specificheTecniche:sco:730
type	DatoCB_Type
facets	Kind Value pattern [01]
source	<xs:element name="AnomaliaDatiSostituto" type="cm:DatoCB_Type" minOccurs="0"/>

element **Dichiarazione_Dich_Type/FuoriAssistenza/AnomaliaDatiRappresentante**

diagram	
namespace	urn:www.agenziaentrate.gov.it:specificheTecniche:sco:730
type	DatoCB_Type
facets	Kind Value pattern [01]
source	<xs:element name="AnomaliaDatiRappresentante" type="cm:DatoCB_Type" minOccurs="0"/>

element **Dichiarazione_Dich_Type/Scelte**

diagram	
namespace	urn:www.agenziaentrate.gov.it:specificheTecniche:sco:730
type	sce:Scelte_Type
children	sce:Scelta5PerMille sce:Scelta8PerMille sce:Scelta2PerMille
source	<code><xs:element name="Scelte" type="sce:Scelte_Type" minOccurs="0"/></code>

complexType **Documento_730-4**

diagram	
namespace	urn:www.agenziaentrate.gov.it:specificheTecniche:sco:730
children	m730:DatiAnagraficiDichiarante m730:Sostituto m730:SoggettoAssFiscale730-4 m730:AltriDati m730:DatiContabili730-4
source	<pre> <xs:complexType name="Documento_730-4"> <xs:sequence> <xs:element name="DatiAnagraficiDichiarante"> <xs:complexType> <xs:complexContent> <xs:extension base="sc:Dati_Anagrafici_Type"> <xs:sequence> <xs:element name="CFDichiarante" type="cm:DatoCF_Type"/> </xs:sequence> </xs:extension> </xs:complexContent> </xs:complexType> </xs:element> <xs:element name="Sostituto" type="m730:Sostituto_Type" minOccurs="0"/> <xs:element name="SoggettoAssFiscale730-4" minOccurs="0"> <xs:complexType> <xs:choice> <xs:element name="DatiCaf730-4"> <xs:complexType> <xs:complexContent> <xs:extension base="m730:Dati_CAF_Type"> <xs:sequence> <xs:element name="DomicilioCaf" type="m730:Domicilio_Sogg_Ass_Fiscale_Type" minOccurs="0"/> </xs:sequence> </xs:extension> </xs:complexContent> </xs:complexType> </xs:element> <xs:element name="UfficioPerifericoCaf" minOccurs="0"> <xs:complexType> </pre>

```

<xs:sequence>
  <xs:element name="DomicilioUffPeriferico">
    <xs:complexType>
      <xs:complexContent>
        <xs:extension base="m730:Domicilio_Sogg_Ass_Fiscale_Type">
          <xs:sequence>
            <xs:element name="CodiceSedePeriferica" type="cm:DatoAN_Type" minOccurs="0"/>
          </xs:sequence>
        </xs:extension>
      </xs:complexContent>
    </xs:complexType>
  </xs:element>
</xs:sequence>
</xs:complexType>
</xs:element>
</xs:sequence>
</xs:extension>
</xs:complexContent>
</xs:complexType>
</xs:element>
<xs:element name="DatiProfessionista730-4">
  <xs:complexType>
    <xs:complexContent>
      <xs:extension base="m730:Dati_Professionista_Type">
        <xs:sequence>
          <xs:element name="DomicilioProf" type="m730:Domicilio_Sogg_Ass_Fiscale_Type"/>
        </xs:sequence>
      </xs:extension>
    </xs:complexContent>
  </xs:complexType>
</xs:element>
<xs:element name="DatiAssociazione730-4">
  <xs:complexType>
    <xs:complexContent>
      <xs:extension base="m730:Dati_Associazioni_Professionale_Type">
        <xs:sequence>
          <xs:element name="DomicilioAssociazione" type="m730:Domicilio_Sogg_Ass_Fiscale_Type"/>
        </xs:sequence>
      </xs:extension>
    </xs:complexContent>
  </xs:complexType>
</xs:element>
</xs:choice>
</xs:complexType>
</xs:element>
<xs:element name="AltriDati" minOccurs="0">
  <xs:complexType>
    <xs:sequence>
      <xs:element name="Rettificativo" type="m730:Rettificativo_Type" minOccurs="0"/>
      <xs:element name="Integrativo" type="m730:Integrativo_Type" minOccurs="0"/>
      <xs:element name="Annullamento" type="cm:DatoCB_Type" minOccurs="0"/>
      <xs:element name="SpazioDisposizioneUtente" type="cm:DatoAN_Type" minOccurs="0"/>
      <xs:element name="SituazioniParticolari" type="cm:DatoNP_Type" minOccurs="0"/>
    </xs:sequence>
  </xs:complexType>
</xs:element>
<xs:element name="DatiContabili730-4" minOccurs="0">
  <xs:complexType>
    <xs:choice>
      <xs:element name="Ordinario_730-4">
        <xs:complexType>
          <xs:sequence>
            <xs:element name="ImportiTrattenere" type="m730:ImportiTrattenere730-4" minOccurs="0"/>
            <xs:element name="ImportiRimborsare" type="m730:Importi_Rimborsare730-4_Type" minOccurs="0"/>
            <xs:element name="Conguaglio" minOccurs="0">
              <xs:complexType>
                <xs:sequence>
                  <xs:element name="NumeroRate" type="cm:DatoN1_Type" minOccurs="0"/>
                </xs:sequence>
              </xs:complexType>
            </xs:element>
          </xs:sequence>
        </xs:complexType>
      </xs:element>
    </xs:choice>
  </xs:complexType>
</xs:element>

```

```

<xs:element name="ImportoRimborsare" type="cm:DatoNP_Type" minOccurs="0"/>
<xs:element name="ImportoTrattenere" type="cm:DatoNP_Type" minOccurs="0"/>
</xs:choice>
</xs:sequence>
</xs:complexType>
</xs:element>
</xs:sequence>
</xs:complexType>
</xs:element>
<xs:element name="Integrativo_730-4">
<xs:complexType>
<xs:sequence>
<xs:element name="ImportiRimborsare" type="m730:Importi_Rimborsare_730-4_Integrativo_Type"/>
</xs:sequence>
</xs:complexType>
</xs:element>
</xs:choice>
</xs:complexType>
</xs:element>
</xs:sequence>
</xs:complexType>

```

element **Documento_730-4/DatiAnagraficiDichiarante**

diagram	<p>The diagram illustrates the structure of the <code>m730:DatiAnagraficiDichiarante</code> element. It is an extension of the <code>sc:Dati_Anagrafici_Type</code> (extension). The structure consists of a sequence of elements: <code>Cognome</code>, <code>Nome</code>, <code>Sesso</code>, <code>DataNascita</code>, <code>ComuneNascita</code>, and <code>ProvinciaNascita</code> (indicated by a dashed box), followed by <code>m730:CFDichiarante</code>.</p>
namespace	urn:www.agenziaentrate.gov.it:specificheTecniche:sco:730
type	extension of Dati_Anagrafici_Type
children	Cognome Nome Sesso DataNascita ComuneNascita ProvinciaNascita m730:CFDichiarante
source	<pre> <xs:element name="DatiAnagraficiDichiarante"> <xs:complexType> <xs:complexContent> <xs:extension base="sc:Dati_Anagrafici_Type"> <xs:sequence> <xs:element name="CFDichiarante" type="cm:DatoCF_Type"/> </xs:sequence> </xs:extension> </xs:complexContent> </xs:complexType> </xs:element> </pre>

element **Documento_730-4/DatiAnagraficiDichiarante/CFDichiarante**

diagram	
namespace	urn:www.agenziaentrate.gov.it:specificheTecniche:sco:730
type	DatoCF_Type
facets	Kind Value pattern [0-9]{11}[A-Z]{6}[0-9LMNPQRSTUUV]{2}[A-Z]{1}[0-9LMNPQRSTUUV]{2}[A-Z]{1}[0-9LMNPQRSTUUV]{3}[A-Z]{1}
source	<xs:element name="CFDichiarante" type="cm:DatoCF_Type"/>

element **Documento_730-4/Sostituto**

diagram	
namespace	urn:www.agenziaentrate.gov.it:specificheTecniche:sco:730
type	m730:Sostituto_Type
children	m730:CodiceFiscale m730:DatiAnagraficiPF m730:DenominazionePNF m730:Residenza m730:Fax m730:CodiceSede
source	<xs:element name="Sostituto" type="m730:Sostituto_Type" minOccurs="0"/>

element **Documento_730-4/SoggettoAssFiscale730-4**

diagram	
namespace	urn:www.agenziaentrate.gov.it:specificheTecniche:sco:730
children	m730:DatiCaf730-4 m730:DatiProfessionista730-4 m730:DatiAssociazione730-4
source	<xs:element name="SoggettoAssFiscale730-4" minOccurs="0"> <xs:complexType> <xs:choice> <xs:element name="DatiCaf730-4"> <xs:complexType> <xs:complexContent> <xs:extension base="m730:Dati_CAF_Type"> <xs:sequence> <xs:element name="DomicilioCaf" type="m730:Domicilio_Sogg_Ass_Fiscale_Type" minOccurs="0"/>

```
<xs:sequence>
  <xs:element name="UfficioPerifericoCaf" minOccurs="0">
    <xs:complexType>
      <xs:sequence>
        <xs:element name="DomicilioUffPeriferico">
          <xs:complexType>
            <xs:complexContent>
              <xs:extension base="m730:Domicilio_Sogg_Ass_Fiscale_Type">
                <xs:sequence>
                  <xs:element name="CodiceSedePeriferica" type="cm:DatoAN_Type" minOccurs="0"/>
                </xs:sequence>
              </xs:extension>
            </xs:complexContent>
          </xs:complexType>
        </xs:element>
      </xs:sequence>
    </xs:complexType>
  </xs:element>
  <xs:element name="DatiProfessionista730-4">
    <xs:complexType>
      <xs:complexContent>
        <xs:extension base="m730:Dati_Professionista_Type">
          <xs:sequence>
            <xs:element name="DomicilioProf" type="m730:Domicilio_Sogg_Ass_Fiscale_Type"/>
          </xs:sequence>
        </xs:extension>
      </xs:complexContent>
    </xs:complexType>
  </xs:element>
  <xs:element name="DatiAssociazione730-4">
    <xs:complexType>
      <xs:complexContent>
        <xs:extension base="m730:Dati_Associazioni_Professionale_Type">
          <xs:sequence>
            <xs:element name="DomicilioAssociazione" type="m730:Domicilio_Sogg_Ass_Fiscale_Type"/>
          </xs:sequence>
        </xs:extension>
      </xs:complexContent>
    </xs:complexType>
  </xs:element>
</xs:choice>
</xs:complexType>
</xs:element>
```

element **Documento_730-4/SoggettoAssFiscale730-4/DatiCaf730-4**

diagram	
namespace	urn:www.agenziaentrate.gov.it:specificheTecniche:sco:730
type	extension of m730:Dati_CAF_Type
children	m730:CFCaf m730:DenominazioneCaf m730:NumeroAlbo m730:DomicilioCaf m730:UfficioPerifericoCaf
source	<pre> <xs:element name="DatiCaf730-4"> <xs:complexType> <xs:complexContent> <xs:extension base="m730:Dati_CAF_Type"> <xs:sequence> <xs:element name="DomicilioCaf" type="m730:Domicilio_Sogg_Ass_Fiscale_Type" minOccurs="0"/> <xs:sequence> <xs:element name="UfficioPerifericoCaf" minOccurs="0"> <xs:complexType> <xs:sequence> <xs:element name="DomicilioUffPeriferico"> <xs:complexType> <xs:complexContent> <xs:extension base="m730:Domicilio_Sogg_Ass_Fiscale_Type"> <xs:sequence> <xs:element name="CodiceSedePeriferica" type="cm:DatoAN_Type" minOccurs="0"/> </xs:sequence> </xs:extension> </xs:complexContent> </xs:complexType> </xs:element> </xs:sequence> </xs:complexType> </xs:element> </xs:sequence> </xs:extension> </xs:complexContent> </xs:complexType> </xs:element> </pre>

element **Documento_730-4/SoggettoAssFiscale730-4/DatiCaf730-4/DomicilioCaf**

diagram	
namespace	urn:www.agenziaentrate.gov.it:specificheTecniche:sco:730
type	m730:Domicilio_Sogg_Ass_Fiscale_Type
children	m730:Comune m730:Provincia m730:CodiceComune m730:Cap m730:Indirizzo m730:Telefono m730:FAX m730:Email
source	<xs:element name="DomicilioCaf" type="m730:Domicilio_Sogg_Ass_Fiscale_Type" minOccurs="0"/>

element **Documento_730-4/SoggettoAssFiscale730-4/DatiCaf730-4/UfficioPerifericoCaf**

diagram	
namespace	urn:www.agenziaentrate.gov.it:specificheTecniche:sco:730
children	m730:DomicilioUffPeriferico
source	<pre> <xs:element name="UfficioPerifericoCaf" minOccurs="0"> <xs:complexType> <xs:sequence> <xs:element name="DomicilioUffPeriferico"> <xs:complexType> <xs:complexContent> <xs:extension base="m730:Domicilio_Sogg_Ass_Fiscale_Type"> <xs:sequence> <xs:element name="CodiceSedePeriferica" type="cm:DatoAN_Type" minOccurs="0"/> </xs:sequence> </xs:extension> </xs:complexContent> </xs:complexType> </xs:element> </xs:sequence> </xs:complexType> </xs:element> </pre>

element **Documento_730-4/SoggettoAssFiscale730-4/DatiCaf730-4/UfficioPerifericoCaf/DomicilioUffPeriferico**

diagram	
namespace	urn:www.agenziaentrate.gov.it:specificheTecniche:sco:730
type	extension of m730:Domicilio_Sogg_Ass_Fiscale_Type
children	m730:Comune m730:Provincia m730:CodiceComune m730:Cap m730:Indirizzo m730:Telefono m730:FAX m730:Email m730:CodiceSedePeriferica
source	<pre><xs:element name="DomicilioUffPeriferico"> <xs:complexType> <xs:complexContent> <xs:extension base="m730:Domicilio_Sogg_Ass_Fiscale_Type"> <xs:sequence> <xs:element name="CodiceSedePeriferica" type="cm:DatoAN_Type" minOccurs="0"/> </xs:sequence> </xs:extension> </xs:complexContent> </xs:complexType> </xs:element></pre>

element **Documento_730-4/SoggettoAssFiscale730-4/DatiCaf730-4/UfficioPerifericoCaf/DomicilioUffPeriferico/CodiceSedePeriferica**

diagram					
namespace	urn:www.agenziaentrate.gov.it:specificheTecniche:sco:730				
type	DatoAN_Type				
facets	<table border="1"> <thead> <tr> <th>Kind</th> <th>Value</th> </tr> </thead> <tbody> <tr> <td>pattern</td> <td>(([0-9A-Z-] &quot;){1}([0-9A-Z&amp;] ' - \., / "^\(\)\) À É È Ì Ò Ù Û &quot; \\ / +)*</td> </tr> </tbody> </table>	Kind	Value	pattern	(([0-9A-Z-] "){1}([0-9A-Z&] ' - \., / "^\(\)\) À É È Ì Ò Ù Û " \\ / +)*
Kind	Value				
pattern	(([0-9A-Z-] "){1}([0-9A-Z&] ' - \., / "^\(\)\) À É È Ì Ò Ù Û " \\ / +)*				
source	<pre><xs:element name="CodiceSedePeriferica" type="cm:DatoAN_Type" minOccurs="0"/></pre>				

element **Documento_730-4/SoggettoAssFiscale730-4/DatiProfessionista730-4**

diagram	
namespace	urn:www.agenziaentrate.gov.it:specificheTecniche:sco:730
type	extension of m730:Dati_Professionista_Type
children	m730:CFProfessionista m730:CognomeProfessionista m730:NomeProfessionista m730:DomicilioProf
source	<pre> <xs:element name="DatiProfessionista730-4"> <xs:complexType> <xs:complexContent> <xs:extension base="m730:Dati_Professionista_Type"> <xs:sequence> <xs:element name="DomicilioProf" type="m730:Domicilio_Sogg_Ass_Fiscale_Type"/> </xs:sequence> </xs:extension> </xs:complexContent> </xs:complexType> </xs:element> </pre>

element **Documento_730-4/SoggettoAssFiscale730-4/DatiProfessionista730-4/DomicilioProf**

diagram	
namespace	urn:www.agenziaentrate.gov.it:specificheTecniche:sco:730
type	m730:Domicilio_Sogg_Ass_Fiscale_Type
children	m730:Comune m730:Provincia m730:CodiceComune m730:Cap m730:Indirizzo m730:Telefono m730:FAX m730:Email

source	<xs:element name="DomicilioProf" type="m730:Domicilio_Sogg_Ass_Fiscale_Type"/>
--------	--

element **Documento_730-4/SoggettoAssFiscale730-4/DatiAssociazione730-4**

diagram	
namespace	urn:www.agenziaentrate.gov.it:specificheTecniche:sco:730
type	extension of m730:Dati_Associazioni_Professionale_Type
children	m730:CFAssociazione m730:DenominazioneAssociazione m730:CFProfessionista m730:CognomeProfessionista m730:NomeProfessionista m730:DomicilioAssociazione
source	<pre> <xs:element name="DatiAssociazione730-4"> <xs:complexType> <xs:complexContent> <xs:extension base="m730:Dati_Associazioni_Professionale_Type"> <xs:sequence> <xs:element name="DomicilioAssociazione" type="m730:Domicilio_Sogg_Ass_Fiscale_Type"/> </xs:sequence> </xs:extension> </xs:complexContent> </xs:complexType> </xs:element> </pre>

element **Documento_730-4/SoggettoAssFiscale730-4/DatiAssociazione730-4/DomicilioAssociazione**

diagram	
namespace	urn:www.agenziaentrate.gov.it:specificheTecniche:sco:730
type	m730:Domicilio_Sogg_Ass_Fiscale_Type
children	m730:Comune m730:Provincia m730:CodiceComune m730:Cap m730:Indirizzo m730:Telefono m730:FAX m730:Email
source	<code><xs:element name="DomicilioAssociazione" type="m730:Domicilio_Sogg_Ass_Fiscale_Type"/></code>

element **Documento_730-4/AltriDati**

diagram	
namespace	urn:www.agenziaentrate.gov.it:specificheTecniche:sco:730
children	m730:Rettificativo m730:Integrativo m730:Annullamento m730:SpazioDisposizioneUtente m730:SituazioniParticolari
source	<pre> <xs:element name="AltriDati" minOccurs="0"> <xs:complexType> <xs:sequence> <xs:element name="Rettificativo" type="m730:Rettificativo_Type" minOccurs="0"/> <xs:element name="Integrativo" type="m730:Integrativo_Type" minOccurs="0"/> <xs:element name="Annullamento" type="cm:DatoCB_Type" minOccurs="0"/> <xs:element name="SpazioDisposizioneUtente" type="cm:DatoAN_Type" minOccurs="0"/> <xs:element name="SituazioniParticolari" type="cm:DatoNP_Type" minOccurs="0"/> </xs:sequence> </xs:complexType> </xs:element> </pre>

element **Documento_730-4/AltriDati/Rettificativo**

diagram											
namespace	urn:www.agenziaentrate.gov.it:specificheTecniche:sco:730										
type	m730:Rettificativo_Type										
facets	<table border="1"> <thead> <tr> <th>Kind</th> <th>Value</th> </tr> </thead> <tbody> <tr> <td>pattern</td> <td>[1-9]</td> </tr> <tr> <td>enumeration</td> <td>1</td> </tr> <tr> <td>enumeration</td> <td>2</td> </tr> <tr> <td>enumeration</td> <td>3</td> </tr> </tbody> </table>	Kind	Value	pattern	[1-9]	enumeration	1	enumeration	2	enumeration	3
Kind	Value										
pattern	[1-9]										
enumeration	1										
enumeration	2										
enumeration	3										
source	<code><xs:element name="Rettificativo" type="m730:Rettificativo_Type" minOccurs="0"/></code>										

element **Documento_730-4/AltriDati/Integrativo**

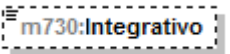
diagram											
namespace	urn:www.agenziaentrate.gov.it:specificheTecniche:sco:730										
type	m730:Integrativo_Type										
facets	<table border="1"> <thead> <tr> <th>Kind</th> <th>Value</th> </tr> </thead> <tbody> <tr> <td>pattern</td> <td>[1-9]</td> </tr> <tr> <td>enumeration</td> <td>1</td> </tr> <tr> <td>enumeration</td> <td>2</td> </tr> <tr> <td>enumeration</td> <td>3</td> </tr> </tbody> </table>	Kind	Value	pattern	[1-9]	enumeration	1	enumeration	2	enumeration	3
Kind	Value										
pattern	[1-9]										
enumeration	1										
enumeration	2										
enumeration	3										
source	<code><xs:element name="Integrativo" type="m730:Integrativo_Type" minOccurs="0"/></code>										

element **Documento_730-4/AltriDati/Annullamento**

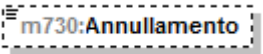
diagram					
namespace	urn:www.agenziaentrate.gov.it:specificheTecniche:sco:730				
type	DatoCB_Type				
facets	<table border="1"> <thead> <tr> <th>Kind</th> <th>Value</th> </tr> </thead> <tbody> <tr> <td>pattern</td> <td>[01]</td> </tr> </tbody> </table>	Kind	Value	pattern	[01]
Kind	Value				
pattern	[01]				
source	<code><xs:element name="Annullamento" type="cm:DatoCB_Type" minOccurs="0"/></code>				

element **Documento_730-4/AltriDati/SpazioDisposizioneUtente**

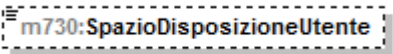
diagram					
namespace	urn:www.agenziaentrate.gov.it:specificheTecniche:sco:730				
type	DatoAN_Type				
facets	<table border="1"> <thead> <tr> <th>Kind</th> <th>Value</th> </tr> </thead> <tbody> <tr> <td>pattern</td> <td>([0-9A-Z-]&quot;){1}([0-9A-Z&amp;] [-\., /°\^\\(\) À É È Ì Ò Ù Û &quot; \\ /+)*</td> </tr> </tbody> </table>	Kind	Value	pattern	([0-9A-Z-]"){1}([0-9A-Z&] [-\., /°\^\\(\) À É È Ì Ò Ù Û " \\ /+)*
Kind	Value				
pattern	([0-9A-Z-]"){1}([0-9A-Z&] [-\., /°\^\\(\) À É È Ì Ò Ù Û " \\ /+)*				
source	<code><xs:element name="SpazioDisposizioneUtente" type="cm:DatoAN_Type" minOccurs="0"/></code>				

element **Documento_730-4/AltriDati/SituazioniParticolari**

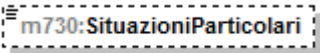
diagram	
namespace	urn:www.agenziaentrate.gov.it:specificheTecniche:sco:730
type	DatoNP_Type
facets	Kind Value pattern [1-9]{1}[0-9]*
source	<code><xs:element name="SituazioniParticolari" type="cm:DatoNP_Type" minOccurs="0"/></code>

element **Documento_730-4/DatiContabili730-4**

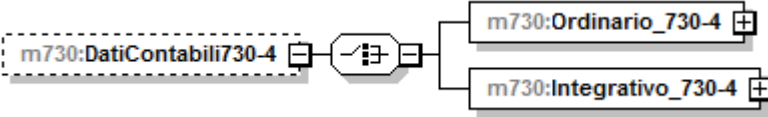
diagram	
namespace	urn:www.agenziaentrate.gov.it:specificheTecniche:sco:730
children	m730:Ordinario_730-4 m730:Integrativo_730-4
source	<pre><xs:element name="DatiContabili730-4" minOccurs="0"> <xs:complexType> <xs:choice> <xs:element name="Ordinario_730-4"> <xs:complexType> <xs:sequence> <xs:element name="ImportiTrattenere" type="m730:ImportiTrattenere730-4" minOccurs="0"/> <xs:element name="ImportiRimborsare" type="m730:Importi_Rimborsare730-4_Type" minOccurs="0"/> <xs:element name="Conguaglio" minOccurs="0"> <xs:complexType> <xs:sequence> <xs:element name="NumeroRate" type="cm:DatoN1_Type" minOccurs="0"/> <xs:choice> <xs:element name="ImportoRimborsare" type="cm:DatoNP_Type" minOccurs="0"/> <xs:element name="ImportoTrattenere" type="cm:DatoNP_Type" minOccurs="0"/> </xs:choice> </xs:sequence> </xs:complexType> </xs:element> </xs:sequence> </xs:complexType> </xs:element> <xs:element name="Integrativo_730-4"> <xs:complexType> <xs:sequence> <xs:element name="ImportiRimborsare" type="m730:Importi_Rimborsare_730-4_Integrativo_Type"/> </xs:sequence> </xs:complexType> </xs:element> </xs:choice> </xs:complexType> </xs:element></pre>

element **Documento_730-4/DatiContabili730-4/Ordinario_730-4**

<p>diagram</p>	
<p>namespace</p>	<p>urn:www.agenziaentrate.gov.it:specificheTecniche:sco:730</p>
<p>children</p>	<p>m730:ImportiTrattenere m730:ImportiRimborsare m730:Conguaglio</p>
<p>source</p>	<pre> <xs:element name="Ordinario_730-4"> <xs:complexType> <xs:sequence> <xs:element name="ImportiTrattenere" type="m730:ImportiTrattenere730-4" minOccurs="0"/> <xs:element name="ImportiRimborsare" type="m730:Importi_Rimborsare730-4_Type" minOccurs="0"/> <xs:element name="Conguaglio" minOccurs="0"> <xs:complexType> <xs:sequence> <xs:element name="NumeroRate" type="cm:DatoN1_Type" minOccurs="0"/> <xs:choice> <xs:element name="ImportoRimborsare" type="cm:DatoNP_Type" minOccurs="0"/> <xs:element name="ImportoTrattenere" type="cm:DatoNP_Type" minOccurs="0"/> </xs:choice> </xs:sequence> </xs:complexType> </xs:element> </xs:sequence> </xs:complexType> </xs:element> </pre>

element **Documento_730-4/DatiContabili730-4/Ordinario_730-4/ImportiTrattenere**

<p>diagram</p>	
<p>namespace</p>	<p>urn:www.agenziaentrate.gov.it:specificheTecniche:sco:730</p>
<p>type</p>	<p>m730:ImportiTrattenere730-4</p>
<p>children</p>	<p>m730:IrpefTrattenere m730:AddRegTrattenere m730:AddComTrattenere m730:IrpefPrimaRataTrattenere m730:IrpefSecondaRataTrattenere m730:TassSepAccontoTrattenere m730:AddComAccontoTrattenere m730:IncrProduitTrattenere m730:CedolareTrattenere m730:CedolarePrimaRataTrattenere m730:CedolareSecondaRataTrattenere m730:ContribSolidTrattenere</p>
<p>source</p>	<p><code><xs:element name="ImportiTrattenere" type="m730:ImportiTrattenere730-4" minOccurs="0"/></code></p>

element **Documento_730-4/DatiContabili730-4/Ordinario_730-4/ImportiRimborsare**

<p>diagram</p>	
<p>namespace</p>	<p>urn:www.agenziaentrate.gov.it:specificheTecniche:sco:730</p>

type	m730:Importi_Rimborsare730-4_Type
children	m730:IrpefRimborsare m730:AddRegRimborsare m730:AddComRimborsare m730:CedolareRimborsare
source	<code><xs:element name="ImportiRimborsare" type="m730:Importi_Rimborsare730-4_Type" minOccurs="0"/></code>

element **Documento_730-4/DatiContabili730-4/Ordinario_730-4/Conguaglio**

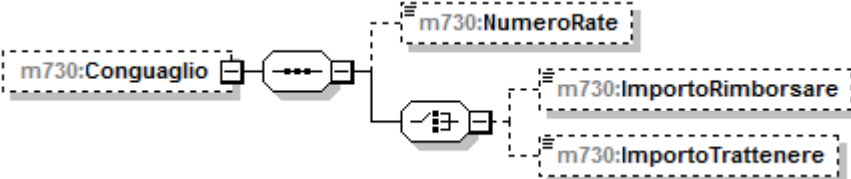
diagram	
namespace	urn:www.agenziaentrate.gov.it:specificheTecniche:sco:730
children	m730:NumeroRate m730:ImportoRimborsare m730:ImportoTrattenere
source	<code><xs:element name="Conguaglio" minOccurs="0"> <xs:complexType> <xs:sequence> <xs:element name="NumeroRate" type="cm:DatoN1_Type" minOccurs="0"/> <xs:choice> <xs:element name="ImportoRimborsare" type="cm:DatoNP_Type" minOccurs="0"/> <xs:element name="ImportoTrattenere" type="cm:DatoNP_Type" minOccurs="0"/> </xs:choice> </xs:sequence> </xs:complexType> </xs:element></code>

element **Documento_730-4/DatiContabili730-4/Ordinario_730-4/Conguaglio/NumeroRate**

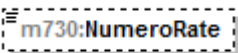
diagram	
namespace	urn:www.agenziaentrate.gov.it:specificheTecniche:sco:730
type	DatoN1_Type
facets	Kind Value pattern [1-9]
source	<code><xs:element name="NumeroRate" type="cm:DatoN1_Type" minOccurs="0"/></code>

element **Documento_730-4/DatiContabili730-4/Ordinario_730-4/Conguaglio/ImportoRimborsare**

diagram	
namespace	urn:www.agenziaentrate.gov.it:specificheTecniche:sco:730
type	DatoNP_Type
facets	Kind Value pattern [1-9]{1}[0-9]*
source	<code><xs:element name="ImportoRimborsare" type="cm:DatoNP_Type" minOccurs="0"/></code>

element **Documento_730-4/DatiContabili730-4/Ordinario_730-4/Conguaglio/ImportoTrattenere**

diagram	
---------	---

namespace	urn:www.agenziaentrate.gov.it:specificheTecniche:sco:730
type	DatoNP_Type
facets	Kind Value pattern [1-9]{1}[0-9]*
source	<xs:element name="ImportoTrattenerere" type="cm:DatoNP_Type" minOccurs="0"/>

element **Documento_730-4/DatiContabili730-4/Integrativo_730-4**

diagram	
namespace	urn:www.agenziaentrate.gov.it:specificheTecniche:sco:730
children	m730:ImportiRimborsare
source	<xs:element name="Integrativo_730-4"> <xs:complexType> <xs:sequence> <xs:element name="ImportiRimborsare" type="m730:Importi_Rimborsare_730-4_Integrativo_Type"/> </xs:sequence> </xs:complexType> </xs:element>

element **Documento_730-4/DatiContabili730-4/Integrativo_730-4/ImportiRimborsare**

diagram	
namespace	urn:www.agenziaentrate.gov.it:specificheTecniche:sco:730
type	m730:Importi_Rimborsare_730-4_Integrativo_Type
children	m730:IrpefRimborsare m730:AddRegRimborsare m730:AddComRimborsare m730:CedolareRimborsare m730:TassazioneSepRimborsare m730:IncrementoProduttivita m730:ContributoSolidarieta
source	<xs:element name="ImportiRimborsare" type="m730:Importi_Rimborsare_730-4_Integrativo_Type"/>

complexType Documento_730_Type

<p>diagram</p>											
<p>namespace</p>	<p>urn:www.agenziaentrate.gov.it:specificheTecniche:sco:730</p>										
<p>type</p>	<p>extension of Documento_Type</p>										
<p>children</p>	<p>m730:DichiarazioneDich m730:DichiarazioneCon m730:AltriDati m730:DichPrecompilata m730:DichNonPrecompilata m730:Sostituto m730:Mod730DipendentiSenzaSostituto m730:SoggettoAssFiscaleDoc m730:Documento_730-4 m730:EsitiContabili m730:DatiRettificati</p>										
<p>attributes</p>	<table border="1"> <thead> <tr> <th>Name</th> <th>Type</th> <th>Use</th> <th>Default</th> <th>Fixed</th> </tr> </thead> <tbody> <tr> <td>identificativo</td> <td>Identificativo_Type</td> <td>required</td> <td></td> <td></td> </tr> </tbody> </table>	Name	Type	Use	Default	Fixed	identificativo	Identificativo_Type	required		
Name	Type	Use	Default	Fixed							
identificativo	Identificativo_Type	required									
<p>source</p>	<pre> <xs:complexType name="Documento_730_Type"> <xs:complexContent> <xs:extension base="cm:Documento_Type"> <xs:sequence> <xs:element name="DichiarazioneDich" type="m730:Dichiarazione_Dich_Type"/> <xs:element name="DichiarazioneCon" type="m730:Dichiarazione_Con_Type" minOccurs="0"/> <xs:element name="AltriDati" minOccurs="0"/> <xs:complexType> <xs:sequence> <xs:element name="FlagConferma" type="cm:DatoCB_Type" minOccurs="0"/> <xs:element name="FlagAssenzaDati730-4" type="cm:DatoCB_Type" minOccurs="0"/> <xs:element name="FlagCfErratoDicTrasmessa" type="cm:DatoCF_Type" minOccurs="0"/> <xs:element name="Rettificativo" type="m730:Rettificativo_Type" minOccurs="0"/> <xs:element name="Integrativo" type="m730:Integrativo_Type" minOccurs="0"/> <xs:element name="CfProduttoreSoftware" type="cm:DatoCF_Type" minOccurs="0"/> <xs:element name="SpazioDisposizioneUtente" type="cm:DatoAN_Type" minOccurs="0"/> <xs:element name="DichiarazioneCongiunta" type="cm:DatoCB_Type" minOccurs="0"/> <xs:element name="SituazioniParticolari" type="cm:DatoNP_Type" minOccurs="0"/> <xs:element name="Mod730SenzaSostituto" minOccurs="0"/> </xs:sequence> </xs:complexType> </xs:sequence> </xs:extension> </xs:complexContent> </xs:complexType> </pre>										

	<pre> <xs:simpleType> <xs:restriction base="cm:DatoAN_Type"> <xs:enumeration value="A"/> </xs:restriction> </xs:simpleType> </xs:element> <xs:element name="ComunicazioneDatiRettificati" type="cm:DatoCB_Type" minOccurs="0"/> </xs:sequence> </xs:complexType> </xs:element> <xs:element name="DichPrecompilata" type="m730:Dich_Precompilata_Type" minOccurs="0"/> <xs:element name="DichNonPrecompilata" type="m730:Dich_Non_Precompilata" minOccurs="0"/> <xs:element name="Sostituto" type="m730:Sostituto_Type" minOccurs="0"/> <xs:element name="Mod730DipendentiSenzaSostituto" type="cm:DatoCB_Type" minOccurs="0"/> <xs:element name="SoggettoAssFiscaleDoc" type="m730:Soggetto_Assistenza_FiscaliDoc_type"/> <xs:element name="Documento_730-4" type="m730:Documento_730-4" minOccurs="0"/> <xs:element name="EsitiContabili" minOccurs="0"/> <xs:complexType> <xs:sequence> <xs:element name="Conguaglio" type="m730:Conguaglio_Type" minOccurs="0"/> <xs:element name="Mod730Integrativo" type="m730:Mod730_Integrativo_Type" minOccurs="0"/> <xs:element name="VersamentiF24" type="m730:Versamenti_F24_Type" minOccurs="0"/> </xs:sequence> </xs:complexType> </xs:element> <xs:element name="DatiRettificati" type="m730:Dati_Rettificati_Type" minOccurs="0"/> </xs:sequence> </xs:extension> </xs:complexContent> </xs:complexType> </pre>
--	--

element **Documento_730_Type/DichiarazioneDich**

diagram	<pre> classDiagram class m730DichiarazioneDich { m730Frontespizio m730DatiContabili m730FuoriAssistenza m730Scelte } </pre>
namespace	urn:www.agenziaentrate.gov.it:specificheTecniche:sco:730
type	m730:Dichiarazione Dich Type
children	m730:Frontespizio m730:DatiContabili m730:FuoriAssistenza m730:Scelte
source	<xs:element name="DichiarazioneDich" type="m730:Dichiarazione_Dich_Type"/>

element **Documento_730_Type/DichiarazioneCon**

diagram	
namespace	urn:www.agenziaentrate.gov.it:specificheTecniche:sco:730
type	m730:Dichiarazione_Con_Type
children	m730:Frontespizio m730:DatiContabili m730:FuoriAssistenzaQuadri m730:Scelte
source	<code><xs:element name="DichiarazioneCon" type="m730:Dichiarazione_Con_Type" minOccurs="0"/></code>

element **Documento_730_Type/AltriDati**

diagram	
namespace	urn:www.agenziaentrate.gov.it:specificheTecniche:sco:730
children	m730:FlagConferma m730:FlagAssenzaDati730-4 m730:FlagCfErratoDicTrasmessa m730:Rettificativo m730:Integrativo m730:CfProduttoreSoftware m730:SpazioDisposizioneUtente m730:DichiarazioneCongiunta m730:SituazioniParticolari m730:Mod730SenzaSostituto m730:ComunicazioneDatiRettificati
source	<pre> <xs:element name="AltriDati" minOccurs="0"> <xs:complexType> <xs:sequence> <xs:element name="FlagConferma" type="cm:DatoCB_Type" minOccurs="0"/> <xs:element name="FlagAssenzaDati730-4" type="cm:DatoCB_Type" minOccurs="0"/> <xs:element name="FlagCfErratoDicTrasmessa" type="cm:DatoCF_Type" minOccurs="0"/> </pre>

	<pre> <xs:element name="Rettificativo" type="m730:Rettificativo_Type" minOccurs="0"/> <xs:element name="Integrativo" type="m730:Integrativo_Type" minOccurs="0"/> <xs:element name="CfProduttoreSoftware" type="cm:DatoCF_Type" minOccurs="0"/> <xs:element name="SpazioDisposizioneUtente" type="cm:DatoAN_Type" minOccurs="0"/> <xs:element name="DichiarazioneCongiunta" type="cm:DatoCB_Type" minOccurs="0"/> <xs:element name="SituazioniParticolari" type="cm:DatoNP_Type" minOccurs="0"/> <xs:element name="Mod730SenzaSostituto" minOccurs="0"> <xs:simpleType> <xs:restriction base="cm:DatoAN_Type"> <xs:enumeration value="A"/> </xs:restriction> </xs:simpleType> </xs:element> <xs:element name="ComunicazioneDatiRettificati" type="cm:DatoCB_Type" minOccurs="0"/> </xs:sequence> </xs:complexType> </xs:element> </pre>
--	---

element **Documento_730_Type/AltriDati/FlagConferma**

diagram					
namespace	urn:www.agenziaentrate.gov.it:specificheTecniche:sco:730				
type	DatoCB_Type				
facets	<table border="1"> <tr> <th>Kind</th> <th>Value</th> </tr> <tr> <td>pattern</td> <td>[01]</td> </tr> </table>	Kind	Value	pattern	[01]
Kind	Value				
pattern	[01]				
source	<code><xs:element name="FlagConferma" type="cm:DatoCB_Type" minOccurs="0"/></code>				

element **Documento_730_Type/AltriDati/FlagAssenzaDati730-4**

diagram					
namespace	urn:www.agenziaentrate.gov.it:specificheTecniche:sco:730				
type	DatoCB_Type				
facets	<table border="1"> <tr> <th>Kind</th> <th>Value</th> </tr> <tr> <td>pattern</td> <td>[01]</td> </tr> </table>	Kind	Value	pattern	[01]
Kind	Value				
pattern	[01]				
source	<code><xs:element name="FlagAssenzaDati730-4" type="cm:DatoCB_Type" minOccurs="0"/></code>				

element **Documento_730_Type/AltriDati/FlagCfErratoDicTrasmessa**

diagram					
namespace	urn:www.agenziaentrate.gov.it:specificheTecniche:sco:730				
type	DatoCF_Type				
facets	<table border="1"> <tr> <th>Kind</th> <th>Value</th> </tr> <tr> <td>pattern</td> <td>[0-9]{11}[A-Z]{6}[0-9LMNPQRSTUUV]{2}[A-Z]{1}[0-9LMNPQRSTUUV]{2}[A-Z]{1}[0-9LMNPQRSTUUV]{3}[A-Z]{1}</td> </tr> </table>	Kind	Value	pattern	[0-9]{11}[A-Z]{6}[0-9LMNPQRSTUUV]{2}[A-Z]{1}[0-9LMNPQRSTUUV]{2}[A-Z]{1}[0-9LMNPQRSTUUV]{3}[A-Z]{1}
Kind	Value				
pattern	[0-9]{11}[A-Z]{6}[0-9LMNPQRSTUUV]{2}[A-Z]{1}[0-9LMNPQRSTUUV]{2}[A-Z]{1}[0-9LMNPQRSTUUV]{3}[A-Z]{1}				
source	<code><xs:element name="FlagCfErratoDicTrasmessa" type="cm:DatoCF_Type" minOccurs="0"/></code>				

element **Documento_730_Type/AltriDati/Rettificativo**

diagram	
namespace	urn:www.agenziaentrate.gov.it:specificheTecniche:sco:730

type	m730:Rettificativo_Type										
facets	<table border="1"> <tr> <td>Kind</td> <td>Value</td> </tr> <tr> <td>pattern</td> <td>[1-9]</td> </tr> <tr> <td>enumeration</td> <td>1</td> </tr> <tr> <td>enumeration</td> <td>2</td> </tr> <tr> <td>enumeration</td> <td>3</td> </tr> </table>	Kind	Value	pattern	[1-9]	enumeration	1	enumeration	2	enumeration	3
Kind	Value										
pattern	[1-9]										
enumeration	1										
enumeration	2										
enumeration	3										
source	<xs:element name="Rettificativo" type="m730:Rettificativo_Type" minOccurs="0"/>										

element **Documento_730_Type/AltriDati/Integrativo**

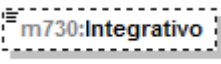
diagram											
namespace	urn:www.agenziaentrate.gov.it:specificheTecniche:sco:730										
type	m730:Integrativo_Type										
facets	<table border="1"> <tr> <td>Kind</td> <td>Value</td> </tr> <tr> <td>pattern</td> <td>[1-9]</td> </tr> <tr> <td>enumeration</td> <td>1</td> </tr> <tr> <td>enumeration</td> <td>2</td> </tr> <tr> <td>enumeration</td> <td>3</td> </tr> </table>	Kind	Value	pattern	[1-9]	enumeration	1	enumeration	2	enumeration	3
Kind	Value										
pattern	[1-9]										
enumeration	1										
enumeration	2										
enumeration	3										
source	<xs:element name="Integrativo" type="m730:Integrativo_Type" minOccurs="0"/>										

element **Documento_730_Type/AltriDati/CfProduttoreSoftware**

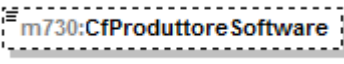
diagram					
namespace	urn:www.agenziaentrate.gov.it:specificheTecniche:sco:730				
type	DatoCF_Type				
facets	<table border="1"> <tr> <td>Kind</td> <td>Value</td> </tr> <tr> <td>pattern</td> <td>[0-9]{11}[A-Z]{6}[0-9LMNPQRSTU]{2}[A-Z]{1}[0-9LMNPQRSTU]{2}[A-Z]{1}[0-9LMNPQRSTU]{3}[A-Z]{1}</td> </tr> </table>	Kind	Value	pattern	[0-9]{11}[A-Z]{6}[0-9LMNPQRSTU]{2}[A-Z]{1}[0-9LMNPQRSTU]{2}[A-Z]{1}[0-9LMNPQRSTU]{3}[A-Z]{1}
Kind	Value				
pattern	[0-9]{11}[A-Z]{6}[0-9LMNPQRSTU]{2}[A-Z]{1}[0-9LMNPQRSTU]{2}[A-Z]{1}[0-9LMNPQRSTU]{3}[A-Z]{1}				
source	<xs:element name="CfProduttoreSoftware" type="cm:DatoCF_Type" minOccurs="0"/>				

element **Documento_730_Type/AltriDati/SpazioDisposizioneUtente**

diagram					
namespace	urn:www.agenziaentrate.gov.it:specificheTecniche:sco:730				
type	DatoAN_Type				
facets	<table border="1"> <tr> <td>Kind</td> <td>Value</td> </tr> <tr> <td>pattern</td> <td>([0-9A-Z-] \&quot;){1}([0-9A-Z&amp;#39; \\- \\. \\/ \\° \\^ \\(\\) \\À \\É \\È \\Ì \\Ò \\Ù \\Û \\&quot; \\ \\ \\ \\+)*</td> </tr> </table>	Kind	Value	pattern	([0-9A-Z-] \"){1}([0-9A-Z&#39; \\- \\. \\/ \\° \\^ \\(\\) \\À \\É \\È \\Ì \\Ò \\Ù \\Û \\" \\ \\ \\ \\+)*
Kind	Value				
pattern	([0-9A-Z-] \"){1}([0-9A-Z&#39; \\- \\. \\/ \\° \\^ \\(\\) \\À \\É \\È \\Ì \\Ò \\Ù \\Û \\" \\ \\ \\ \\+)*				
source	<xs:element name="SpazioDisposizioneUtente" type="cm:DatoAN_Type" minOccurs="0"/>				

element **Documento_730_Type/AltriDati/DichiarazioneCongiunta**

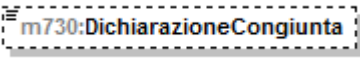
diagram					
namespace	urn:www.agenziaentrate.gov.it:specificheTecniche:sco:730				
type	DatoCB_Type				
facets	<table border="1"> <tr> <td>Kind</td> <td>Value</td> </tr> <tr> <td>pattern</td> <td>[01]</td> </tr> </table>	Kind	Value	pattern	[01]
Kind	Value				
pattern	[01]				
source	<xs:element name="DichiarazioneCongiunta" type="cm:DatoCB_Type" minOccurs="0"/>				

element **Documento_730_Type/AltriDati/SituazioniParticolari**

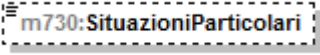
diagram	
namespace	urn:www.agenziaentrate.gov.it:specificheTecniche:sco:730
type	DatoNP_Type
facets	Kind Value pattern [1-9]{1}[0-9]*
source	<code><xs:element name="SituazioniParticolari" type="cm:DatoNP_Type" minOccurs="0"/></code>

element **Documento_730_Type/AltriDati/Mod730SenzaSostituto**

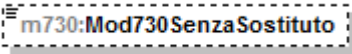
diagram	
namespace	urn:www.agenziaentrate.gov.it:specificheTecniche:sco:730
type	restriction of DatoAN_Type
facets	Kind Value pattern ([0-9A-Z-] "){1}([0-9A-Z&] ' \" \. / ° ^\(\\) À È É Ì Ò Ù Ü " \\ / +)* enumeration A
source	<code><xs:element name="Mod730SenzaSostituto" minOccurs="0"> <xs:simpleType> <xs:restriction base="cm:DatoAN_Type"> <xs:enumeration value="A"/> </xs:restriction> </xs:simpleType> </xs:element></code>

element **Documento_730_Type/AltriDati/ComunicazioneDatiRettificati**

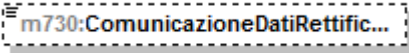
diagram	
namespace	urn:www.agenziaentrate.gov.it:specificheTecniche:sco:730
type	DatoCB_Type
facets	Kind Value pattern [01]
source	<code><xs:element name="ComunicazioneDatiRettificati" type="cm:DatoCB_Type" minOccurs="0"/></code>

element **Documento_730_Type/DichPrecompilata**

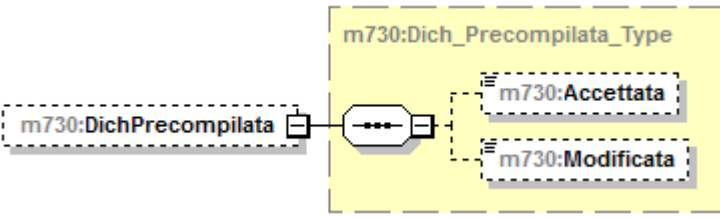
diagram	
namespace	urn:www.agenziaentrate.gov.it:specificheTecniche:sco:730
type	m730:Dich_Precompilata_Type
children	m730:Accettata m730:Modificata

source	<xs:element name="DichPrecompilata" type="m730:Dich_Precompilata_Type" minOccurs="0"/>
--------	--

element **Documento_730_Type/DichNonPrecompilata**

diagram	
namespace	urn:www.agenziaentrate.gov.it:specificheTecniche:sco:730
type	m730:Dich_Non_Precompilata
children	m730:PrecompNonPresente m730:SostCafProfessNonDelegato
source	<xs:element name="DichNonPrecompilata" type="m730:Dich_Non_Precompilata" minOccurs="0"/>

element **Documento_730_Type/Sostituto**

diagram	
namespace	urn:www.agenziaentrate.gov.it:specificheTecniche:sco:730
type	m730:Sostituto_Type
children	m730:CodiceFiscale m730:DatiAnagraficiPF m730:DenominazionePNF m730:Residenza m730:Fax m730:CodiceSede
source	<xs:element name="Sostituto" type="m730:Sostituto_Type" minOccurs="0"/>

element **Documento_730_Type/Mod730DipendentiSenzaSostituto**

diagram					
namespace	urn:www.agenziaentrate.gov.it:specificheTecniche:sco:730				
type	DatoCB_Type				
facets	<table border="1"> <thead> <tr> <th>Kind</th> <th>Value</th> </tr> </thead> <tbody> <tr> <td>pattern</td> <td>[01]</td> </tr> </tbody> </table>	Kind	Value	pattern	[01]
Kind	Value				
pattern	[01]				
source	<xs:element name="Mod730DipendentiSenzaSostituto" type="cm:DatoCB_Type" minOccurs="0"/>				

element **Documento_730_Type/SoggettoAssFiscaleDoc**

<p>diagram</p>	
<p>namespace</p>	<p>urn:www.agenziaentrate.gov.it:specificheTecniche:sco:730</p>
<p>type</p>	<p>m730:Soggetto_Assistenza_FiscaliDoc type</p>
<p>children</p>	<p>m730:DataConsegna m730:TipologiaSoggettoAssFisc m730:SostitutoCF m730:DatiCafDoc m730:DatiProfessionistaDoc m730:DatiAssociazioneDoc m730:AgenziaEntrate</p>
<p>source</p>	<p><xs:element name="SoggettoAssFiscaleDoc" type="m730:Soggetto_Assistenza_FiscaliDoc_type"/></p>

element **Documento_730_Type/Documento_730-4**

<p>diagram</p>	
<p>namespace</p>	<p>urn:www.agenziaentrate.gov.it:specificheTecniche:sco:730</p>
<p>type</p>	<p>m730:Documento_730-4</p>
<p>children</p>	<p>m730:DatiAnagraficiDichiarante m730:Sostituto m730:SoggettoAssFiscale730-4 m730:AltriDati m730:DatiContabili730-4</p>
<p>source</p>	<p><xs:element name="Documento_730-4" type="m730:Documento_730-4" minOccurs="0"/></p>

element **Documento_730_Type/EsitiContabili**

diagram	
namespace	urn:www.agenziaentrate.gov.it:specificheTecniche:sco:730
children	m730:Conguaglio m730:Mod730Integrativo m730:VersamentiF24
source	<pre><xs:element name="EsitiContabili" minOccurs="0"> <xs:complexType> <xs:sequence> <xs:element name="Conguaglio" type="m730:Conguaglio_Type" minOccurs="0"/> <xs:element name="Mod730Integrativo" type="m730:Mod730_Integrativo_Type" minOccurs="0"/> <xs:element name="VersamentiF24" type="m730:Versamenti_F24_Type" minOccurs="0"/> </xs:sequence> </xs:complexType> </xs:element></pre>

element **Documento_730_Type/EsitiContabili/Conguaglio**

diagram	
namespace	urn:www.agenziaentrate.gov.it:specificheTecniche:sco:730
type	m730:Conguaglio_Type
children	m730:NumeroRate m730:ImportoTrattenutoSaldo m730:ImportoTrattenutoAcconto m730:ImportoDaVersareF24Saldo m730:ImportoDaVersareF24Acc... m730:ImportoRimborsato m730:ImportoRimborsatoAgenzia m730:CasellaRimbAgenziaCasiPart m730:OpzioneInformativa
source	<pre><xs:element name="Conguaglio" type="m730:Conguaglio_Type" minOccurs="0"/></pre>

element **Documento_730_Type/EsitiContabili/Mod730Integrativo**

diagram	<p>The diagram illustrates the structure of the <code>m730:Mod730_Integrativo_Type</code>. It shows a root element <code>m730:Mod730Integrativo</code> (represented by a dashed box) containing a sequence of four child elements (represented by solid boxes):</p> <ul style="list-style-type: none"> <code>m730:ImportiRimborsare</code> (required, indicated by a '+' sign) <code>m730:ImportoRimborsato</code> (optional, indicated by a dashed line) <code>m730:ImportoRimborsatoAgenzia</code> (optional, indicated by a dashed line) <code>m730:CasellaRimbAgenziaCasiP...</code> (optional, indicated by a dashed line)
namespace	urn:www.agenziaentrate.gov.it:specificheTecniche:sco:730
type	m730:Mod730_Integrativo_Type
children	m730:ImportiRimborsare m730:ImportoRimborsato m730:ImportoRimborsatoAgenzia m730:CasellaRimbAgenziaCasiPart
source	<code><xs:element name="Mod730Integrativo" type="m730:Mod730_Integrativo_Type" minOccurs="0"/></code>

element Documento_730_Type/EsitiContabili/VersamentiF24

<p>diagram</p>	
<p>namespace</p>	<p>urn:www.agenziaentrate.gov.it:specificheTecniche:sco:730</p>
<p>type</p>	<p>m730:Versamenti_F24_Type</p>
<p>children</p>	<p>m730:F24DebitoIrpef m730:F24DebitoCodRegione m730:F24DebitoAddReg m730:F24DebitoCodComune m730:F24DebitoAddCom m730:F24DebitoPrimaRataAcclrpef m730:F24DebitoAccontoTassSep m730:F24DebitoCodComuneAcconto m730:F24DebitoAccontoAddCom m730:F24DebitoImpSostProduit</p>

	m730:F24DebitoCedolare m730:F24DebitoPrimaRataAccCedolare m730:F24DebitoContribSolidarieta m730:F24DebitoCodRegioneConiuge m730:F24DebitoAddRegConiuge m730:F24DebitoCodComuneConiuge m730:F24DebitoAddComConiuge m730:F24DebitoCodComuneAccontoConiuge m730:F24DebitoAccontoAddComConiuge m730:F24DebitoSecondaRataAcclrpef m730:F24DebitoSecondaRataAccCedolare
source	<xs:element name="VersamentiF24" type="m730:Versamenti_F24_Type" minOccurs="0"/>

element **Documento_730_Type/DatiRettificati**

diagram	
namespace	urn:www.agenziaentrate.gov.it:specificheTecniche:sco:730
type	m730:Dati_Rettificati_Type
children	m730:Rettifica
source	<xs:element name="DatiRettificati" type="m730:Dati_Rettificati_Type" minOccurs="0"/>

complexType **Domicilio_Fiscale_type**

diagram	
namespace	urn:www.agenziaentrate.gov.it:specificheTecniche:sco:730
children	m730:Comune m730:Provincia m730:CodiceComune
source	<pre><xs:complexType name="Domicilio_Fiscale_type"> <xs:sequence> <xs:element name="Comune" type="cm:DatoAN_Type"/> <xs:element name="Provincia" type="cm:PR_Type"/> <xs:element name="CodiceComune" type="cm:DatoAN_Type"/> </xs:sequence> </xs:complexType></pre>

element **Domicilio_Fiscale_type/Comune**

diagram					
namespace	urn:www.agenziaentrate.gov.it:specificheTecniche:sco:730				
type	DatoAN_Type				
facets	<table border="1"> <thead> <tr> <th>Kind</th> <th>Value</th> </tr> </thead> <tbody> <tr> <td>pattern</td> <td>(([0-9A-Z-] \&quot;){1}([0-9A-Z&amp;:] \- \, / * \^ \(\) \) \) \&Eacute; \&Ecirc; \&Ograve; \&Ugrave; \&Uml; \&quot; \&backslash; \&plus;)*</td> </tr> </tbody> </table>	Kind	Value	pattern	(([0-9A-Z-] \"){1}([0-9A-Z&:] \- \, / * \^ \(\) \) \) \É \Ê \Ò \Ù \&Uml; \" \&backslash; \+)*
Kind	Value				
pattern	(([0-9A-Z-] \"){1}([0-9A-Z&:] \- \, / * \^ \(\) \) \) \É \Ê \Ò \Ù \&Uml; \" \&backslash; \+)*				
source	<xs:element name="Comune" type="cm:DatoAN_Type"/>				

element **Domicilio_Sogg_Ass_Fiscale_Type/Comune**

diagram	
namespace	urn:www.agenziaentrate.gov.it:specificheTecniche:sco:730
type	DatoAN_Type
facets	Kind Value pattern (([0-9A-Z-] \"){1}([0-9A-Z&] " - \., / "^\(\\) À É È Ì Ò Ù Û " \\ / +)*
source	<xs:element name="Comune" type="cm:DatoAN_Type" minOccurs="0"/>

element **Domicilio_Sogg_Ass_Fiscale_Type/Provincia**

diagram	
namespace	urn:www.agenziaentrate.gov.it:specificheTecniche:sco:730
type	PR_Type
source	<xs:element name="Provincia" type="cm:PR_Type" minOccurs="0"/>

element **Domicilio_Sogg_Ass_Fiscale_Type/CodiceComune**

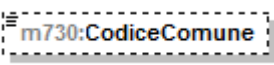
diagram	
namespace	urn:www.agenziaentrate.gov.it:specificheTecniche:sco:730
type	DatoAN_Type
facets	Kind Value pattern (([0-9A-Z-] \"){1}([0-9A-Z&] " - \., / "^\(\\) À É È Ì Ò Ù Û " \\ / +)*
source	<xs:element name="CodiceComune" type="cm:DatoAN_Type" minOccurs="0"/>

element **Domicilio_Sogg_Ass_Fiscale_Type/Cap**

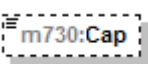
diagram	
namespace	urn:www.agenziaentrate.gov.it:specificheTecniche:sco:730
type	DatoAN_Type
facets	Kind Value pattern (([0-9A-Z-] \"){1}([0-9A-Z&] " - \., / "^\(\\) À É È Ì Ò Ù Û " \\ / +)*
source	<xs:element name="Cap" type="cm:DatoAN_Type" minOccurs="0"/>

element **Domicilio_Sogg_Ass_Fiscale_Type/Indirizzo**

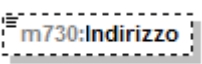
diagram	
namespace	urn:www.agenziaentrate.gov.it:specificheTecniche:sco:730
type	DatoAN_Type
facets	Kind Value pattern (([0-9A-Z-] \"){1}([0-9A-Z&] " - \., / "^\(\\) À É È Ì Ò Ù Û " \\ / +)*
source	<xs:element name="Indirizzo" type="cm:DatoAN_Type" minOccurs="0"/>

element **Domicilio_Sogg_Ass_Fiscale_Type/Telefono**

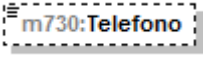
diagram					
namespace	urn:www.agenziaentrate.gov.it:specificheTecniche:sco:730				
type	DatoAN_Type				
facets	<table border="1"> <thead> <tr> <th>Kind</th> <th>Value</th> </tr> </thead> <tbody> <tr> <td>pattern</td> <td>(([0-9A-Z\-\]]&quot;){1}([0-9A-Z&amp;:] [\-\.\, / ^\\(\\) À É È Ì Ò Ù Û &quot; \\ \\+])*</td> </tr> </tbody> </table>	Kind	Value	pattern	(([0-9A-Z\-\]]"){1}([0-9A-Z&:] [\-\.\, / ^\\(\\) À É È Ì Ò Ù Û " \\ \\+])*
Kind	Value				
pattern	(([0-9A-Z\-\]]"){1}([0-9A-Z&:] [\-\.\, / ^\\(\\) À É È Ì Ò Ù Û " \\ \\+])*				
source	<xs:element name="Telefono" type="cm:DatoAN_Type" minOccurs="0"/>				

element **Domicilio_Sogg_Ass_Fiscale_Type/FAX**

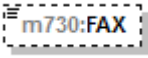
diagram					
namespace	urn:www.agenziaentrate.gov.it:specificheTecniche:sco:730				
type	DatoAN_Type				
facets	<table border="1"> <thead> <tr> <th>Kind</th> <th>Value</th> </tr> </thead> <tbody> <tr> <td>pattern</td> <td>(([0-9A-Z\-\]]&quot;){1}([0-9A-Z&amp;:] [\-\.\, / ^\\(\\) À É È Ì Ò Ù Û &quot; \\ \\+])*</td> </tr> </tbody> </table>	Kind	Value	pattern	(([0-9A-Z\-\]]"){1}([0-9A-Z&:] [\-\.\, / ^\\(\\) À É È Ì Ò Ù Û " \\ \\+])*
Kind	Value				
pattern	(([0-9A-Z\-\]]"){1}([0-9A-Z&:] [\-\.\, / ^\\(\\) À É È Ì Ò Ù Û " \\ \\+])*				
source	<xs:element name="FAX" type="cm:DatoAN_Type" minOccurs="0"/>				

element **Domicilio_Sogg_Ass_Fiscale_Type/Email**

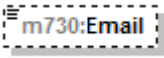
diagram					
namespace	urn:www.agenziaentrate.gov.it:specificheTecniche:sco:730				
type	DatoEM_Type				
facets	<table border="1"> <thead> <tr> <th>Kind</th> <th>Value</th> </tr> </thead> <tbody> <tr> <td>pattern</td> <td>[a-zA-Z0-9_%\-\&quot;?^~=]+@[a-zA-Z0-9\-\.\,]+\.[a-zA-Z]{2,4}</td> </tr> </tbody> </table>	Kind	Value	pattern	[a-zA-Z0-9_%\-\"?^~=]+@[a-zA-Z0-9\-\.\,]+\.[a-zA-Z]{2,4}
Kind	Value				
pattern	[a-zA-Z0-9_%\-\"?^~=]+@[a-zA-Z0-9\-\.\,]+\.[a-zA-Z]{2,4}				
source	<xs:element name="Email" type="cm:DatoEM_Type" minOccurs="0"/>				

complexType **Eccedenze_Type**

<p>diagram</p>	
<p>namespace</p>	<p>urn:www.agenziaentrate.gov.it:specificheTecniche:sco:730</p>
<p>children</p>	<p>m730:lrp ef m730:lrp efCompF24 m730:SostitutivaQuadroRT m730:SostitutivaQuadroRTcompF24 m730:CedolareSecca m730:CedolareSeccaCompF24 m730:CodiceRegione m730:AddRegionalelrp ef m730:AddRegionalelrp efCompF24 m730:CodiceCatastaleComune m730:AddComunalelrp ef m730:AddComunalelrp efF24</p>
<p>source</p>	<pre> <xs:complexType name="Eccedenze_Type"> <xs:sequence> <xs:element name="lrp ef" type="cm:DatoNP_Type" minOccurs="0"/> <xs:element name="lrp efCompF24" type="cm:DatoNP_Type" minOccurs="0"/> <xs:element name="SostitutivaQuadroRT" type="cm:DatoNP_Type" minOccurs="0"/> <xs:element name="SostitutivaQuadroRTcompF24" type="cm:DatoNP_Type" minOccurs="0"/> <xs:element name="CedolareSecca" type="cm:DatoNP_Type" minOccurs="0"/> <xs:element name="CedolareSeccaCompF24" type="cm:DatoNP_Type" minOccurs="0"/> <xs:element name="CodiceRegione" type="sc:Codice_Regione_Type" minOccurs="0"/> <xs:element name="AddRegionalelrp ef" type="cm:DatoNP_Type" minOccurs="0"/> <xs:element name="AddRegionalelrp efCompF24" type="cm:DatoNP_Type" minOccurs="0"/> <xs:element name="CodiceCatastaleComune" minOccurs="0"> <xs:simpleType> <xs:restriction base="cm:DatoAN_Type"> <xs:length value="4"/> </xs:restriction> </xs:simpleType> </xs:element> <xs:element name="AddComunalelrp ef" type="cm:DatoNP_Type" minOccurs="0"/> <xs:element name="AddComunalelrp efF24" type="cm:DatoNP_Type" minOccurs="0"/> </xs:sequence> </xs:complexType> </pre>

element **Eccedenze_Type/Irpef**

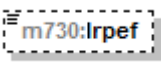
diagram	
namespace	urn:www.agenziaentrate.gov.it:specificheTecniche:sco:730
type	DatoNP_Type
facets	Kind Value pattern [1-9]{1}[0-9]*
source	<xs:element name="Irpef" type="cm:DatoNP_Type" minOccurs="0"/>

element **Eccedenze_Type/IrpefCompF24**

diagram	
namespace	urn:www.agenziaentrate.gov.it:specificheTecniche:sco:730
type	DatoNP_Type
facets	Kind Value pattern [1-9]{1}[0-9]*
source	<xs:element name="IrpefCompF24" type="cm:DatoNP_Type" minOccurs="0"/>

element **Eccedenze_Type/SostitutivaQuadroRT**

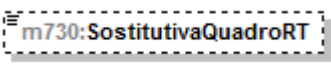
diagram	
namespace	urn:www.agenziaentrate.gov.it:specificheTecniche:sco:730
type	DatoNP_Type
facets	Kind Value pattern [1-9]{1}[0-9]*
source	<xs:element name="SostitutivaQuadroRT" type="cm:DatoNP_Type" minOccurs="0"/>

element **Eccedenze_Type/SostitutivaQuadroRTcompF24**

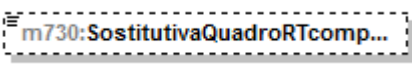
diagram	
namespace	urn:www.agenziaentrate.gov.it:specificheTecniche:sco:730
type	DatoNP_Type
facets	Kind Value pattern [1-9]{1}[0-9]*
source	<xs:element name="SostitutivaQuadroRTcompF24" type="cm:DatoNP_Type" minOccurs="0"/>

element **Eccedenze_Type/CedolareSecca**

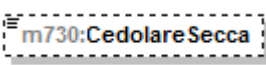
diagram	
namespace	urn:www.agenziaentrate.gov.it:specificheTecniche:sco:730
type	DatoNP_Type
facets	Kind Value pattern [1-9]{1}[0-9]*
source	<xs:element name="CedolareSecca" type="cm:DatoNP_Type" minOccurs="0"/>

element **Eccedenze_Type/CedolareSeccaCompF24**

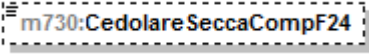
diagram					
namespace	urn:www.agenziaentrate.gov.it:specificheTecniche:sco:730				
type	DatoNP_Type				
facets	<table border="1"> <thead> <tr> <th>Kind</th> <th>Value</th> </tr> </thead> <tbody> <tr> <td>pattern</td> <td>[1-9]{1}[0-9]*</td> </tr> </tbody> </table>	Kind	Value	pattern	[1-9]{1}[0-9]*
Kind	Value				
pattern	[1-9]{1}[0-9]*				
source	<xs:element name="CedolareSeccaCompF24" type="cm:DatoNP_Type" minOccurs="0"/>				

element **Eccedenze_Type/CodiceRegione**

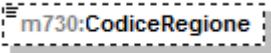
diagram																																															
namespace	urn:www.agenziaentrate.gov.it:specificheTecniche:sco:730																																														
type	Codice_Regione_Type																																														
facets	<table border="1"> <thead> <tr> <th>Kind</th> <th>Value</th> </tr> </thead> <tbody> <tr> <td>pattern</td> <td>([0-9A-Z\-\]]&quot;){1}([0-9A-Z&amp;]] \- \. / \° \^ \(\) À È É ì ò Ù Ü &quot; \ \\ \ +)*</td> </tr> <tr><td>enumeration</td><td>1</td></tr> <tr><td>enumeration</td><td>2</td></tr> <tr><td>enumeration</td><td>3</td></tr> <tr><td>enumeration</td><td>4</td></tr> <tr><td>enumeration</td><td>5</td></tr> <tr><td>enumeration</td><td>6</td></tr> <tr><td>enumeration</td><td>7</td></tr> <tr><td>enumeration</td><td>8</td></tr> <tr><td>enumeration</td><td>9</td></tr> <tr><td>enumeration</td><td>10</td></tr> <tr><td>enumeration</td><td>11</td></tr> <tr><td>enumeration</td><td>12</td></tr> <tr><td>enumeration</td><td>13</td></tr> <tr><td>enumeration</td><td>14</td></tr> <tr><td>enumeration</td><td>15</td></tr> <tr><td>enumeration</td><td>16</td></tr> <tr><td>enumeration</td><td>17</td></tr> <tr><td>enumeration</td><td>18</td></tr> <tr><td>enumeration</td><td>19</td></tr> <tr><td>enumeration</td><td>20</td></tr> <tr><td>enumeration</td><td>21</td></tr> </tbody> </table>	Kind	Value	pattern	([0-9A-Z\-\]]"){1}([0-9A-Z&]] \- \. / \° \^ \(\) À È É ì ò Ù Ü " \ \\ \ +)*	enumeration	1	enumeration	2	enumeration	3	enumeration	4	enumeration	5	enumeration	6	enumeration	7	enumeration	8	enumeration	9	enumeration	10	enumeration	11	enumeration	12	enumeration	13	enumeration	14	enumeration	15	enumeration	16	enumeration	17	enumeration	18	enumeration	19	enumeration	20	enumeration	21
Kind	Value																																														
pattern	([0-9A-Z\-\]]"){1}([0-9A-Z&]] \- \. / \° \^ \(\) À È É ì ò Ù Ü " \ \\ \ +)*																																														
enumeration	1																																														
enumeration	2																																														
enumeration	3																																														
enumeration	4																																														
enumeration	5																																														
enumeration	6																																														
enumeration	7																																														
enumeration	8																																														
enumeration	9																																														
enumeration	10																																														
enumeration	11																																														
enumeration	12																																														
enumeration	13																																														
enumeration	14																																														
enumeration	15																																														
enumeration	16																																														
enumeration	17																																														
enumeration	18																																														
enumeration	19																																														
enumeration	20																																														
enumeration	21																																														
source	<xs:element name="CodiceRegione" type="sc:Codice_Regione_Type" minOccurs="0"/>																																														

element **Eccedenze_Type/AddRegionalelrpef**

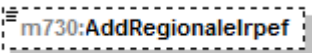
diagram					
namespace	urn:www.agenziaentrate.gov.it:specificheTecniche:sco:730				
type	DatoNP_Type				
facets	<table border="1"> <thead> <tr> <th>Kind</th> <th>Value</th> </tr> </thead> <tbody> <tr> <td>pattern</td> <td>[1-9]{1}[0-9]*</td> </tr> </tbody> </table>	Kind	Value	pattern	[1-9]{1}[0-9]*
Kind	Value				
pattern	[1-9]{1}[0-9]*				
source	<xs:element name="AddRegionalelrpef" type="cm:DatoNP_Type" minOccurs="0"/>				

element **Eccedenze_Type/AddRegionalelrpefCompF24**

diagram	
namespace	urn:www.agenziaentrate.gov.it:specificheTecniche:sco:730
type	DatoNP_Type
facets	Kind Value pattern [1-9]{1}[0-9]*
source	<xs:element name="AddRegionalelrpefCompF24" type="cm:DatoNP_Type" minOccurs="0"/>

element **Eccedenze_Type/CodiceCatastaleComune**

diagram	
namespace	urn:www.agenziaentrate.gov.it:specificheTecniche:sco:730
type	restriction of DatoAN_Type
facets	Kind Value pattern (([0-9A-Z-] "){1}([0-9A-Z&]; \\- \\. \\/ \\° \\^ \\(\\) \\À \\É \\È \\Ì \\Ò \\Ù \\Ü " \\ \\ \\ +)*
source	<xs:element name="CodiceCatastaleComune" minOccurs="0"> <xs:simpleType> <xs:restriction base="cm:DatoAN_Type"> <xs:length value="4"/> </xs:restriction> </xs:simpleType> </xs:element>

element **Eccedenze_Type/AddComunalelrpef**

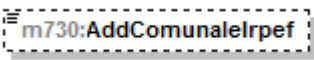
diagram	
namespace	urn:www.agenziaentrate.gov.it:specificheTecniche:sco:730
type	DatoNP_Type
facets	Kind Value pattern [1-9]{1}[0-9]*
source	<xs:element name="AddComunalelrpef" type="cm:DatoNP_Type" minOccurs="0"/>

element **Eccedenze_Type/AddComunalelrpefF24**

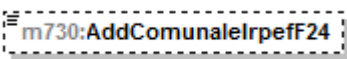
diagram	
namespace	urn:www.agenziaentrate.gov.it:specificheTecniche:sco:730
type	DatoNP_Type
facets	Kind Value pattern [1-9]{1}[0-9]*
source	<xs:element name="AddComunalelrpefF24" type="cm:DatoNP_Type" minOccurs="0"/>

complexType **Elemento_Integrativo_Type**

diagram	
namespace	urn:www.agenziaentrate.gov.it:specificheTecniche:sco:730
children	m730:lrpief m730:AddizionaleRegionalelrpief m730:AddComunalelrpief m730:CedolareSecca
source	<pre><xs:complexType name="Elemento_Integrativo_Type"> <xs:sequence> <xs:element name="lrpief" type="cm:DatoNP_Type" minOccurs="0"/> <xs:element name="AddizionaleRegionalelrpief" type="cm:DatoNP_Type" minOccurs="0"/> <xs:element name="AddComunalelrpief" type="cm:DatoNP_Type" minOccurs="0"/> <xs:element name="CedolareSecca" type="cm:DatoNP_Type" minOccurs="0"/> </xs:sequence> </xs:complexType></pre>

element **Elemento_Integrativo_Type/lrpief**

diagram					
namespace	urn:www.agenziaentrate.gov.it:specificheTecniche:sco:730				
type	DatoNP_Type				
facets	<table border="1"> <thead> <tr> <th>Kind</th> <th>Value</th> </tr> </thead> <tbody> <tr> <td>pattern</td> <td>[1-9]{1}[0-9]*</td> </tr> </tbody> </table>	Kind	Value	pattern	[1-9]{1}[0-9]*
Kind	Value				
pattern	[1-9]{1}[0-9]*				
source	<pre><xs:element name="lrpief" type="cm:DatoNP_Type" minOccurs="0"/></pre>				

element **Elemento_Integrativo_Type/AddizionaleRegionalelrpief**

diagram					
namespace	urn:www.agenziaentrate.gov.it:specificheTecniche:sco:730				
type	DatoNP_Type				
facets	<table border="1"> <thead> <tr> <th>Kind</th> <th>Value</th> </tr> </thead> <tbody> <tr> <td>pattern</td> <td>[1-9]{1}[0-9]*</td> </tr> </tbody> </table>	Kind	Value	pattern	[1-9]{1}[0-9]*
Kind	Value				
pattern	[1-9]{1}[0-9]*				
source	<pre><xs:element name="AddizionaleRegionalelrpief" type="cm:DatoNP_Type" minOccurs="0"/></pre>				

element **Elemento_Integrativo_Type/AddComunalelrpief**

diagram					
namespace	urn:www.agenziaentrate.gov.it:specificheTecniche:sco:730				
type	DatoNP_Type				
facets	<table border="1"> <thead> <tr> <th>Kind</th> <th>Value</th> </tr> </thead> <tbody> <tr> <td>pattern</td> <td>[1-9]{1}[0-9]*</td> </tr> </tbody> </table>	Kind	Value	pattern	[1-9]{1}[0-9]*
Kind	Value				
pattern	[1-9]{1}[0-9]*				
source	<pre><xs:element name="AddComunalelrpief" type="cm:DatoNP_Type" minOccurs="0"/></pre>				

element **Elemento_Integrativo_Type/CedolareSecca**

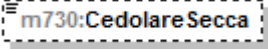
diagram	
namespace	urn:www.agenziaentrate.gov.it:specificheTecniche:sco:730
type	DatoNP_Type
facets	Kind Value pattern [1-9]{1}[0-9]*
source	<xs:element name="CedolareSecca" type="cm:DatoNP_Type" minOccurs="0"/>

complexType **Esenzione_Add_Comunale_Type**

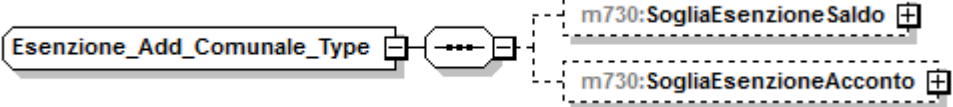
diagram	
namespace	urn:www.agenziaentrate.gov.it:specificheTecniche:sco:730
children	m730:SogliaEsenzioneSaldo m730:SogliaEsenzioneAcconto
source	<xs:complexType name="Esenzione_Add_Comunale_Type"> <xs:sequence> <xs:element name="SogliaEsenzioneSaldo" type="m730:Soglie_Esenzione_Type" minOccurs="0"/> <xs:element name="SogliaEsenzioneAcconto" type="m730:Soglie_Esenzione_Type" minOccurs="0"/> </xs:sequence> </xs:complexType>

element **Esenzione_Add_Comunale_Type/SogliaEsenzioneSaldo**

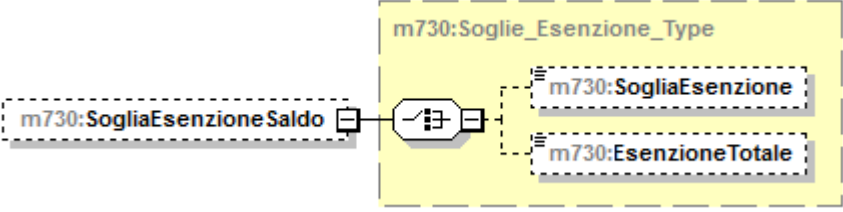
diagram	
namespace	urn:www.agenziaentrate.gov.it:specificheTecniche:sco:730
type	m730:Soglie_Esenzione_Type
children	m730:SogliaEsenzione m730:EsenzioneTotale
source	<xs:element name="SogliaEsenzioneSaldo" type="m730:Soglie_Esenzione_Type" minOccurs="0"/>

element **Esenzione_Add_Comunale_Type/SogliaEsenzioneAcconto**

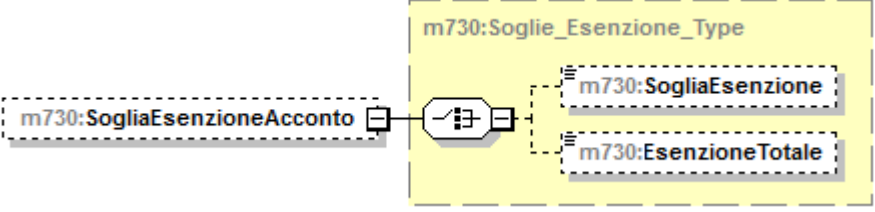
diagram	
namespace	urn:www.agenziaentrate.gov.it:specificheTecniche:sco:730

type	m730:Soglie Esenzione Type
children	m730:SogliaEsenzione m730:EsenzioneTotale
source	<code><xs:element name="SogliaEsenzioneAcconto" type="m730:Soglie_Esenzione_Type" minOccurs="0"/></code>

complexType **Esito_Liquidazione_Type**

diagram	
namespace	urn:www.agenziaentrate.gov.it:specificheTecniche:sco:730
children	m730:Credito m730:Debito
source	<code><xs:complexType name="Esito_Liquidazione_Type"> <xs:choice> <xs:element name="Credito" type="m730:Credito_Type"/> <xs:element name="Debito" type="m730:Debito_Type"/> </xs:choice> </xs:complexType></code>

element **Esito_Liquidazione_Type/Credito**

diagram	
namespace	urn:www.agenziaentrate.gov.it:specificheTecniche:sco:730
type	m730:Credito_Type
children	m730:NonRimborsabile m730:Credito m730:CreditoF24 m730:CreditoRimborso
source	<code><xs:element name="Credito" type="m730:Credito_Type"/></code>

element **Esito_Liquidazione_Type/Debito**

diagram	
namespace	urn:www.agenziaentrate.gov.it:specificheTecniche:sco:730
type	m730:Debito_Type

children	m730:NonVersare m730:ImportoDaTrattenere
source	<xs:element name="Debito" type="m730:Debito_Type"/>

complexType **FabbricatoAgev_Type**

diagram	
namespace	urn:www.agenziaentrate.gov.it:specificheTecniche:sco:730
children	m730:NumeroRigoRiferimento m730:NumModuloRiferimento m730:DatiContratto m730:CasellaInf30Giorni m730:AnnoDichiarazioneIcilmu m730:StatoEmergenza
source	<pre><xs:complexType name="FabbricatoAgev_Type"> <xs:sequence> <xs:element name="NumeroRigoRiferimento" type="m730:FabbricatoAgev_Numero_Rigo_Type"/> <xs:element name="NumModuloRiferimento" type="cm:DatoNP_Type"/> <xs:choice> <xs:element name="DatiContratto" type="m730:Dati_Contratto_Type"/> <xs:element name="CasellaInf30Giorni" type="cm:DatoCB_Type"/> </xs:choice> <xs:element name="AnnoDichiarazioneIcilmu" type="cm:DatoDA_Type" minOccurs="0"/> <xs:element name="StatoEmergenza" type="cm:DatoCB_Type" minOccurs="0"/> </xs:sequence> </xs:complexType></pre>

element **FabbricatoAgev_Type/NumeroRigoRiferimento**

diagram																									
namespace	urn:www.agenziaentrate.gov.it:specificheTecniche:sco:730																								
type	m730:FabbricatoAgev_Numero_Rigo_Type																								
facets	<table border="1"> <thead> <tr> <th>Kind</th> <th>Value</th> </tr> </thead> <tbody> <tr> <td>pattern</td> <td>[1-9]{1}[0-9]*</td> </tr> <tr> <td>enumeration</td> <td>1</td> </tr> <tr> <td>enumeration</td> <td>2</td> </tr> <tr> <td>enumeration</td> <td>3</td> </tr> <tr> <td>enumeration</td> <td>4</td> </tr> <tr> <td>enumeration</td> <td>5</td> </tr> <tr> <td>enumeration</td> <td>6</td> </tr> <tr> <td>enumeration</td> <td>7</td> </tr> <tr> <td>enumeration</td> <td>8</td> </tr> <tr> <td>enumeration</td> <td>9</td> </tr> <tr> <td>enumeration</td> <td>10</td> </tr> </tbody> </table>	Kind	Value	pattern	[1-9]{1}[0-9]*	enumeration	1	enumeration	2	enumeration	3	enumeration	4	enumeration	5	enumeration	6	enumeration	7	enumeration	8	enumeration	9	enumeration	10
Kind	Value																								
pattern	[1-9]{1}[0-9]*																								
enumeration	1																								
enumeration	2																								
enumeration	3																								
enumeration	4																								
enumeration	5																								
enumeration	6																								
enumeration	7																								
enumeration	8																								
enumeration	9																								
enumeration	10																								
source	<xs:element name="NumeroRigoRiferimento" type="m730:FabbricatoAgev_Numero_Rigo_Type"/>																								

element **FabbricatoAgev_Type/NumModuloRiferimento**

diagram	
namespace	urn:www.agenziaentrate.gov.it:specificheTecniche:sco:730
type	DatoNP_Type
facets	Kind Value pattern [1-9]{1}[0-9]*
source	<xs:element name="NumModuloRiferimento" type="cm:DatoNP_Type"/>

element **FabbricatoAgev_Type/DatiContratto**

diagram	
namespace	urn:www.agenziaentrate.gov.it:specificheTecniche:sco:730
type	m730:Dati_Contratto_Type
children	m730:DataRegContratto m730:SerieContratto m730:NumeroContratto m730:Sottonumero m730:CodiceUfficio
source	<xs:element name="DatiContratto" type="m730:Dati_Contratto_Type"/>

element **FabbricatoAgev_Type/CasellaInf30Giorni**

diagram	
namespace	urn:www.agenziaentrate.gov.it:specificheTecniche:sco:730
type	DatoCB_Type
facets	Kind Value pattern [01]
source	<xs:element name="CasellaInf30Giorni" type="cm:DatoCB_Type"/>

element **FabbricatoAgev_Type/AnnoDichiarazioneIcilmu**

diagram	
namespace	urn:www.agenziaentrate.gov.it:specificheTecniche:sco:730
type	DatoDA_Type
facets	Kind Value pattern (18 19 20)[0-9]{2}
source	<xs:element name="AnnoDichiarazioneIcilmu" type="cm:DatoDA_Type" minOccurs="0"/>

element **FabbricatoAgev_Type/StatoEmergenza**

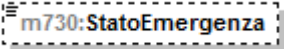
diagram	
namespace	urn:www.agenziaentrate.gov.it:specificheTecniche:sco:730
type	DatoCB_Type
facets	Kind Value pattern [01]
source	<code><xs:element name="StatoEmergenza" type="cm:DatoCB_Type" minOccurs="0"/></code>

complexType **FabbricatoOrd_Type**

diagram	
namespace	urn:www.agenziaentrate.gov.it:specificheTecniche:sco:730
children	m730:Rendita m730:Utilizzo m730:GiorniPossesso m730:PercPossesso m730:CodiceCanone m730:CanoneLocazione m730:CasiParticolari m730:CasellaContinuazione m730:CodiceComune m730:OpzioneCedolare m730:CasellaCasiPartimu
source	<pre><xs:complexType name="FabbricatoOrd_Type"> <xs:sequence> <xs:element name="Rendita" type="cm:DatoNP_Type" minOccurs="0"/> <xs:element name="Utilizzo"> <xs:simpleType> <xs:restriction base="m730:Utilizzo_Fabbricato_Type"/> </xs:simpleType> </xs:element> <xs:element name="GiorniPossesso" minOccurs="0"> <xs:simpleType> <xs:restriction base="cm:DatoNP_Type"> <xs:maxLength value="3"/> </xs:restriction> </xs:simpleType> </xs:element> <xs:element name="PercPossesso" type="cm:DatoPC_Type" minOccurs="0"/> </xs:sequence> </xs:complexType></pre>

	<pre> <xs:element name="CodiceCanone" type="m730:CodiceCanone_Type" minOccurs="0"/> <xs:element name="CanoneLocazione" type="cm:DatoNP_Type" minOccurs="0"/> <xs:element name="CasiParticolari" type="m730:CasiParticolariFabbricato_Type" minOccurs="0"/> <xs:element name="CasellaContinuazione" type="cm:DatoCB_Type" minOccurs="0"/> <xs:element name="CodiceComune" minOccurs="0"> <xs:simpleType> <xs:restriction base="cm:DatoAN_Type"> <xs:length value="4"/> </xs:restriction> </xs:simpleType> </xs:element> <xs:element name="OpzioneCedolare" type="cm:DatoCB_Type" minOccurs="0"/> <xs:element name="CasellaCasiPartImu" minOccurs="0"> <xs:simpleType> <xs:restriction base="cm:DatoN1_Type"> <xs:enumeration value="1"/> <xs:enumeration value="2"/> <xs:enumeration value="3"/> </xs:restriction> </xs:simpleType> </xs:element> </xs:sequence> </xs:complexType> </pre>
--	--

element **FabbricatoOrd_Type/Rendita**

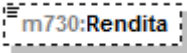
diagram					
namespace	urn:www.agenziaentrate.gov.it:specificheTecniche:sco:730				
type	DatoNP_Type				
facets	<table border="1"> <thead> <tr> <th>Kind</th> <th>Value</th> </tr> </thead> <tbody> <tr> <td>pattern</td> <td>[1-9]{1}[0-9]*</td> </tr> </tbody> </table>	Kind	Value	pattern	[1-9]{1}[0-9]*
Kind	Value				
pattern	[1-9]{1}[0-9]*				
source	<pre><xs:element name="Rendita" type="cm:DatoNP_Type" minOccurs="0"/></pre>				

element **FabbricatoOrd_Type/Utilizzo**

diagram																																	
namespace	urn:www.agenziaentrate.gov.it:specificheTecniche:sco:730																																
type	restriction of m730:Utilizzo Fabbricato_Type																																
facets	<table border="1"> <thead> <tr> <th>Kind</th> <th>Value</th> </tr> </thead> <tbody> <tr> <td>pattern</td> <td>[1-9]{1}[0-9]*</td> </tr> <tr> <td>enumeration</td> <td>1</td> </tr> <tr> <td>enumeration</td> <td>2</td> </tr> <tr> <td>enumeration</td> <td>3</td> </tr> <tr> <td>enumeration</td> <td>4</td> </tr> <tr> <td>enumeration</td> <td>5</td> </tr> <tr> <td>enumeration</td> <td>8</td> </tr> <tr> <td>enumeration</td> <td>9</td> </tr> <tr> <td>enumeration</td> <td>10</td> </tr> <tr> <td>enumeration</td> <td>11</td> </tr> <tr> <td>enumeration</td> <td>12</td> </tr> <tr> <td>enumeration</td> <td>14</td> </tr> <tr> <td>enumeration</td> <td>15</td> </tr> <tr> <td>enumeration</td> <td>16</td> </tr> <tr> <td>enumeration</td> <td>17</td> </tr> </tbody> </table>	Kind	Value	pattern	[1-9]{1}[0-9]*	enumeration	1	enumeration	2	enumeration	3	enumeration	4	enumeration	5	enumeration	8	enumeration	9	enumeration	10	enumeration	11	enumeration	12	enumeration	14	enumeration	15	enumeration	16	enumeration	17
Kind	Value																																
pattern	[1-9]{1}[0-9]*																																
enumeration	1																																
enumeration	2																																
enumeration	3																																
enumeration	4																																
enumeration	5																																
enumeration	8																																
enumeration	9																																
enumeration	10																																
enumeration	11																																
enumeration	12																																
enumeration	14																																
enumeration	15																																
enumeration	16																																
enumeration	17																																
source	<pre> <xs:element name="Utilizzo"> <xs:simpleType> <xs:restriction base="m730:Utilizzo_Fabbricato_Type"/> </xs:simpleType> </xs:element> </pre>																																

element **FabbricatoOrd_Type/GiorniPossesso**

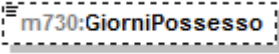
diagram					
namespace	urn:www.agenziaentrate.gov.it:specificheTecniche:sco:730				
type	restriction of DatoNP_Type				
facets	<table border="1"> <thead> <tr> <th>Kind</th> <th>Value</th> </tr> </thead> <tbody> <tr> <td>pattern</td> <td>[1-9]{1}[0-9]*</td> </tr> </tbody> </table>	Kind	Value	pattern	[1-9]{1}[0-9]*
Kind	Value				
pattern	[1-9]{1}[0-9]*				
source	<pre><xs:element name="GiorniPossesso" minOccurs="0"> <xs:simpleType> <xs:restriction base="cm:DatoNP_Type"> <xs:maxLength value="3"/> </xs:restriction> </xs:simpleType> </xs:element></pre>				

element **FabbricatoOrd_Type/PercPossesso**

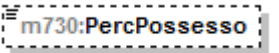
diagram					
namespace	urn:www.agenziaentrate.gov.it:specificheTecniche:sco:730				
type	DatoPC_Type				
facets	<table border="1"> <thead> <tr> <th>Kind</th> <th>Value</th> </tr> </thead> <tbody> <tr> <td>pattern</td> <td>[0-9]?[0-9](,(\d{1,3})?)? 100(,0{1,3})?</td> </tr> </tbody> </table>	Kind	Value	pattern	[0-9]?[0-9](,(\d{1,3})?)? 100(,0{1,3})?
Kind	Value				
pattern	[0-9]?[0-9](,(\d{1,3})?)? 100(,0{1,3})?				
source	<pre><xs:element name="PercPossesso" type="cm:DatoPC_Type" minOccurs="0"/></pre>				

element **FabbricatoOrd_Type/CodiceCanone**

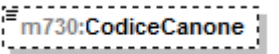
diagram													
namespace	urn:www.agenziaentrate.gov.it:specificheTecniche:sco:730												
type	m730:CodiceCanone_Type												
facets	<table border="1"> <thead> <tr> <th>Kind</th> <th>Value</th> </tr> </thead> <tbody> <tr> <td>pattern</td> <td>[1-9]</td> </tr> <tr> <td>enumeration</td> <td>1</td> </tr> <tr> <td>enumeration</td> <td>2</td> </tr> <tr> <td>enumeration</td> <td>3</td> </tr> <tr> <td>enumeration</td> <td>4</td> </tr> </tbody> </table>	Kind	Value	pattern	[1-9]	enumeration	1	enumeration	2	enumeration	3	enumeration	4
Kind	Value												
pattern	[1-9]												
enumeration	1												
enumeration	2												
enumeration	3												
enumeration	4												
source	<pre><xs:element name="CodiceCanone" type="m730:CodiceCanone_Type" minOccurs="0"/></pre>												

element **FabbricatoOrd_Type/CanoneLocazione**

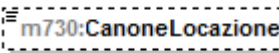
diagram					
namespace	urn:www.agenziaentrate.gov.it:specificheTecniche:sco:730				
type	DatoNP_Type				
facets	<table border="1"> <thead> <tr> <th>Kind</th> <th>Value</th> </tr> </thead> <tbody> <tr> <td>pattern</td> <td>[1-9]{1}[0-9]*</td> </tr> </tbody> </table>	Kind	Value	pattern	[1-9]{1}[0-9]*
Kind	Value				
pattern	[1-9]{1}[0-9]*				
source	<pre><xs:element name="CanoneLocazione" type="cm:DatoNP_Type" minOccurs="0"/></pre>				

element **FabbricatoOrd_Type/CasiParticolari**

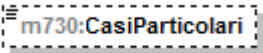
diagram															
namespace	urn:www.agenziaentrate.gov.it:specificheTecniche:sco:730														
type	m730:CasiParticolariFabbricato_Type														
facets	<table border="1"> <thead> <tr> <th>Kind</th> <th>Value</th> </tr> </thead> <tbody> <tr> <td>pattern</td> <td>[1-9]</td> </tr> <tr> <td>enumeration</td> <td>1</td> </tr> <tr> <td>enumeration</td> <td>3</td> </tr> <tr> <td>enumeration</td> <td>4</td> </tr> <tr> <td>enumeration</td> <td>5</td> </tr> <tr> <td>enumeration</td> <td>6</td> </tr> </tbody> </table>	Kind	Value	pattern	[1-9]	enumeration	1	enumeration	3	enumeration	4	enumeration	5	enumeration	6
Kind	Value														
pattern	[1-9]														
enumeration	1														
enumeration	3														
enumeration	4														
enumeration	5														
enumeration	6														
source	<code><xs:element name="CasiParticolari" type="m730:CasiParticolariFabbricato_Type" minOccurs="0"/></code>														

element **FabbricatoOrd_Type/CasellaContinuazione**

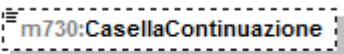
diagram					
namespace	urn:www.agenziaentrate.gov.it:specificheTecniche:sco:730				
type	DatoCB_Type				
facets	<table border="1"> <thead> <tr> <th>Kind</th> <th>Value</th> </tr> </thead> <tbody> <tr> <td>pattern</td> <td>[01]</td> </tr> </tbody> </table>	Kind	Value	pattern	[01]
Kind	Value				
pattern	[01]				
source	<code><xs:element name="CasellaContinuazione" type="cm:DatoCB_Type" minOccurs="0"/></code>				

element **FabbricatoOrd_Type/CodiceComune**

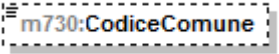
diagram					
namespace	urn:www.agenziaentrate.gov.it:specificheTecniche:sco:730				
type	restriction of DatoAN_Type				
facets	<table border="1"> <thead> <tr> <th>Kind</th> <th>Value</th> </tr> </thead> <tbody> <tr> <td>pattern</td> <td>([0-9A-Z-])&quot;}{1}([0-9A-Z&amp;:] [-\., /°\^\(\)\ À È É Ì Ò Ù Û &quot; \ \ \+)*</td> </tr> </tbody> </table>	Kind	Value	pattern	([0-9A-Z-])"}{1}([0-9A-Z&:] [-\., /°\^\(\)\ À È É Ì Ò Ù Û " \ \ \+)*
Kind	Value				
pattern	([0-9A-Z-])"}{1}([0-9A-Z&:] [-\., /°\^\(\)\ À È É Ì Ò Ù Û " \ \ \+)*				
source	<pre> <xs:element name="CodiceComune" minOccurs="0"> <xs:simpleType> <xs:restriction base="cm:DatoAN_Type"> <xs:length value="4"/> </xs:restriction> </xs:simpleType> </xs:element> </pre>				

element **FabbricatoOrd_Type/OpzioneCedolare**

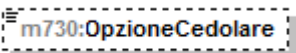
diagram					
namespace	urn:www.agenziaentrate.gov.it:specificheTecniche:sco:730				
type	DatoCB_Type				
facets	<table border="1"> <thead> <tr> <th>Kind</th> <th>Value</th> </tr> </thead> <tbody> <tr> <td>pattern</td> <td>[01]</td> </tr> </tbody> </table>	Kind	Value	pattern	[01]
Kind	Value				
pattern	[01]				
source	<code><xs:element name="OpzioneCedolare" type="cm:DatoCB_Type" minOccurs="0"/></code>				

element **FabbricatoOrd_Type/CasellaCasiPartImu**

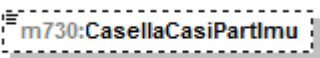
diagram											
namespace	urn:www.agenziaentrate.gov.it:specificheTecniche:sco:730										
type	restriction of DatoN1_Type										
facets	<table border="1"> <thead> <tr> <th>Kind</th> <th>Value</th> </tr> </thead> <tbody> <tr> <td>pattern</td> <td>[1-9]</td> </tr> <tr> <td>enumeration</td> <td>1</td> </tr> <tr> <td>enumeration</td> <td>2</td> </tr> <tr> <td>enumeration</td> <td>3</td> </tr> </tbody> </table>	Kind	Value	pattern	[1-9]	enumeration	1	enumeration	2	enumeration	3
Kind	Value										
pattern	[1-9]										
enumeration	1										
enumeration	2										
enumeration	3										
source	<pre><xs:element name="CasellaCasiPartImu" minOccurs="0"> <xs:simpleType> <xs:restriction base="cm:DatoN1_Type"> <xs:enumeration value="1"/> <xs:enumeration value="2"/> <xs:enumeration value="3"/> </xs:restriction> </xs:simpleType> </xs:element></pre>										

complexType **Familiari_PrimoModulo_Type**

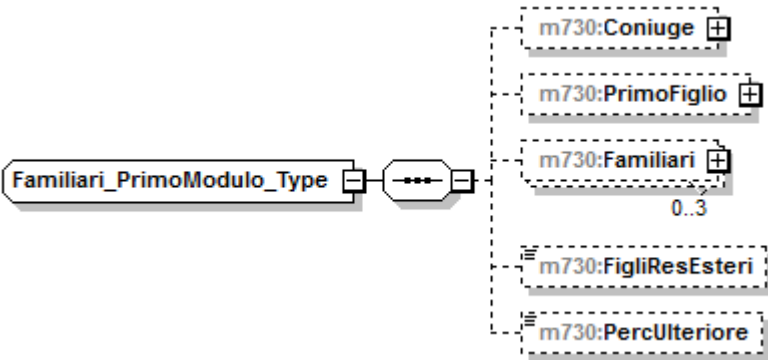
diagram	
namespace	urn:www.agenziaentrate.gov.it:specificheTecniche:sco:730
children	m730:Coniuge m730:PrimoFiglio m730:Familiari m730:FigliResEsteri m730:PercUlteriore
source	<pre><xs:complexType name="Familiari_PrimoModulo_Type"> <xs:sequence> <xs:element name="Coniuge" type="m730:Dati_Coniuge_Type" minOccurs="0"/> <xs:element name="PrimoFiglio" minOccurs="0"> <xs:complexType> <xs:complexContent> <xs:extension base="m730:Dati_Familiare_Type"> <xs:sequence> <xs:element name="Tipo"> <xs:simpleType> <xs:restriction base="cm:DatoAN_Type"> <xs:enumeration value="F"/> <xs:enumeration value="D"/> </xs:restriction> </xs:simpleType> </xs:element> </xs:sequence> </xs:extension> </xs:complexContent> </xs:complexType> </xs:element> <xs:element name="Familiari" minOccurs="0" maxOccurs="3"> <xs:complexType></pre>

	<pre> <xs:complexContent> <xs:extension base="m730:Dati_Familiare_Type"> <xs:sequence> <xs:element name="Tipo"> <xs:simpleType> <xs:restriction base="cm:DatoAN_Type"> <xs:enumeration value="F"/> <xs:enumeration value="D"/> <xs:enumeration value="A"/> </xs:restriction> </xs:simpleType> </xs:element> </xs:sequence> </xs:extension> </xs:complexContent> </xs:complexType> </xs:element> <xs:element name="FigliResEsteri" type="cm:DatoNP_Type" minOccurs="0"/> <xs:element name="PercUlteriore" type="cm:DatoPC_Type" minOccurs="0"/> </xs:sequence> </xs:complexType> </pre>
--	--

element **Familiari_PrimoModulo_Type/Coniuge**

diagram	<pre> classDiagram class m730Coniuge { } class m730DatiConiugeType { } class m730Tipo { } class m730CodiceFiscale { } class m730Mesi { } m730Coniuge .. m730DatiConiugeType m730DatiConiugeType .. m730Tipo m730DatiConiugeType .. m730CodiceFiscale m730DatiConiugeType .. m730Mesi </pre>
namespace	urn:www.agenziaentrate.gov.it:specificheTecniche:sco:730
type	m730:Dati_Coniuge_Type
children	m730:Tipo m730:CodiceFiscale m730:Mesi
source	<xs:element name="Coniuge" type="m730:Dati_Coniuge_Type" minOccurs="0"/>

element **Familiari_PrimoModulo_Type/PrimoFiglio**

diagram	
namespace	urn:www.agenziaentrate.gov.it:specificheTecniche:sco:730
type	extension of m730:Dati Familiare Type
children	m730:CodiceFiscale m730:Mesi m730:MesiMinore m730:PercDetraz m730:PercDetrazCon m730:Affidamento m730:Tipo
source	<pre> <xs:element name="PrimoFiglio" minOccurs="0"> <xs:complexType> <xs:complexContent> <xs:extension base="m730:Dati_Familiare_Type"> <xs:sequence> <xs:element name="Tipo"> <xs:simpleType> <xs:restriction base="cm:DatoAN_Type"> <xs:enumeration value="F"/> <xs:enumeration value="D"/> </xs:restriction> </xs:simpleType> </xs:element> </xs:sequence> </xs:extension> </xs:complexContent> </xs:complexType> </xs:element> </pre>

element **Familiari_PrimoModulo_Type/PrimoFiglio/Tipo**

diagram									
namespace	urn:www.agenziaentrate.gov.it:specificheTecniche:sco:730								
type	restriction of DatoAN_Type								
facets	<table border="0"> <tr> <td>Kind</td> <td>Value</td> </tr> <tr> <td>pattern</td> <td>([0-9A-Z-])&quot;){1}([0-9A-Z&amp;] ' \" \\. / ° \\v\\(\\ \\)À È É Ì Ò Ù Ü &quot; \\ \\ +)*</td> </tr> <tr> <td>enumeration</td> <td>F</td> </tr> <tr> <td>enumeration</td> <td>D</td> </tr> </table>	Kind	Value	pattern	([0-9A-Z-])"){1}([0-9A-Z&] ' \" \\. / ° \\v\\(\\ \\)À È É Ì Ò Ù Ü " \\ \\ +)*	enumeration	F	enumeration	D
Kind	Value								
pattern	([0-9A-Z-])"){1}([0-9A-Z&] ' \" \\. / ° \\v\\(\\ \\)À È É Ì Ò Ù Ü " \\ \\ +)*								
enumeration	F								
enumeration	D								
source	<pre> <xs:element name="Tipo"> <xs:simpleType> <xs:restriction base="cm:DatoAN_Type"> <xs:enumeration value="F"/> <xs:enumeration value="D"/> </xs:restriction> </xs:simpleType> </xs:element> </pre>								

	<pre> </xs:restriction> </xs:simpleType> </xs:element> </pre>
--	---

element **Familiari_PrimoModulo_Type/Familiari**

diagram	
namespace	urn:www.agenziaentrate.gov.it:specificheTecniche:sco:730
type	extension of m730:Dati_Familiare_Type
children	m730:CodiceFiscale m730:Mesi m730:MesiMinore m730:PercDetraz m730:PercDetrazCon m730:Affidamento m730:Tipo
source	<pre> <xs:element name="Familiari" minOccurs="0" maxOccurs="3"> <xs:complexType> <xs:complexContent> <xs:extension base="m730:Dati_Familiare_Type"> <xs:sequence> <xs:element name="Tipo"> <xs:simpleType> <xs:restriction base="cm:DatoAN_Type"> <xs:enumeration value="F"/> <xs:enumeration value="D"/> <xs:enumeration value="A"/> </xs:restriction> </xs:simpleType> </xs:element> </xs:sequence> </xs:extension> </xs:complexContent> </xs:complexType> </xs:element> </pre>

element **Familiari_PrimoModulo_Type/Familiari/Tipo**

diagram					
namespace	urn:www.agenziaentrate.gov.it:specificheTecniche:sco:730				
type	restriction of DatoAN_Type				
facets	<table border="1"> <thead> <tr> <th>Kind</th> <th>Value</th> </tr> </thead> <tbody> <tr> <td>pattern</td> <td>((0-9A-Z- &quot;){1}([0-9A-Z&amp;] ' \" . / ° \\ \\(\\) À É Ê Ï Ò Ù Û &quot; \\ \\ \\ +)*</td> </tr> </tbody> </table>	Kind	Value	pattern	((0-9A-Z- "){1}([0-9A-Z&] ' \" . / ° \\ \\(\\) À É Ê Ï Ò Ù Û " \\ \\ \\ +)*
Kind	Value				
pattern	((0-9A-Z- "){1}([0-9A-Z&] ' \" . / ° \\ \\(\\) À É Ê Ï Ò Ù Û " \\ \\ \\ +)*				

	enumeration F enumeration D enumeration A
source	<pre><xs:element name="Tipo"> <xs:simpleType> <xs:restriction base="cm:DatoAN_Type"> <xs:enumeration value="F"/> <xs:enumeration value="D"/> <xs:enumeration value="A"/> </xs:restriction> </xs:simpleType> </xs:element></pre>

element **Familiari_PrimoModulo_Type/FigliResEsteri**

diagram	
namespace	urn:www.agenziaentrate.gov.it:specificheTecniche:sco:730
type	DatoNP_Type
facets	Kind Value pattern [1-9]{1}[0-9]*
source	<pre><xs:element name="FigliResEsteri" type="cm:DatoNP_Type" minOccurs="0"/></pre>

element **Familiari_PrimoModulo_Type/PercUlteriore**

diagram	
namespace	urn:www.agenziaentrate.gov.it:specificheTecniche:sco:730
type	DatoPC_Type
facets	Kind Value pattern [0-9]?[0-9](, d(1,3))?[100,0(1,3)]?
source	<pre><xs:element name="PercUlteriore" type="cm:DatoPC_Type" minOccurs="0"/></pre>

complexType **Familiari_Type**

diagram	
namespace	urn:www.agenziaentrate.gov.it:specificheTecniche:sco:730
children	m730:PrimoModulo m730:Modulo
source	<pre><xs:complexType name="Familiari_Type"> <xs:sequence> <xs:element name="PrimoModulo"> <xs:complexType> <xs:complexContent> <xs:extension base="m730:Modulo_Familiari_Type"> <xs:sequence> <xs:element name="PercUlteriore" type="cm:DatoPC_Type" minOccurs="0"/> <xs:element name="FigliAffidoPread" type="cm:DatoNP_Type" minOccurs="0"/> </xs:sequence> </xs:extension> </xs:complexContent> </xs:complexType> </xs:element> </xs:sequence> </xs:complexType></pre>

	<pre> </xs:element> <xs:element name="Modulo" type="m730:Modulo_Familiari_Type" minOccurs="0" maxOccurs="unbounded"/> </xs:sequence> </xs:complexType> </pre>
--	---

element **Familiari_Type/PrimoModulo**

diagram	
namespace	urn:www.agenziaentrate.gov.it:specificheTecniche:sco:730
type	extension of m730:Modulo_Familiari_Type
children	m730:Coniuge m730:PrimoFiglio m730:Familiari m730:PercUlteriore m730:FigliAffidoPread
source	<pre> <xs:element name="PrimoModulo"> <xs:complexType> <xs:complexContent> <xs:extension base="m730:Modulo_Familiari_Type"> <xs:sequence> <xs:element name="PercUlteriore" type="cm:DatoPC_Type" minOccurs="0"/> <xs:element name="FigliAffidoPread" type="cm:DatoNP_Type" minOccurs="0"/> </xs:sequence> </xs:extension> </xs:complexContent> </xs:complexType> </xs:element> </pre>

element **Familiari_Type/PrimoModulo/PercUlteriore**

diagram					
namespace	urn:www.agenziaentrate.gov.it:specificheTecniche:sco:730				
type	DatoPC_Type				
facets	<table border="1"> <thead> <tr> <th>Kind</th> <th>Value</th> </tr> </thead> <tbody> <tr> <td>pattern</td> <td>[0-9]?[0-9](,\d{1,3})? 100,0{1,3}?</td> </tr> </tbody> </table>	Kind	Value	pattern	[0-9]?[0-9](,\d{1,3})? 100,0{1,3}?
Kind	Value				
pattern	[0-9]?[0-9](,\d{1,3})? 100,0{1,3}?				
source	<pre> <xs:element name="PercUlteriore" type="cm:DatoPC_Type" minOccurs="0"/> </pre>				

element **Familiari_Type/PrimoModulo/FigliAffidoPread**

diagram	
namespace	urn:www.agenziaentrate.gov.it:specificheTecniche:sco:730

type	DatoNP_Type
facets	Kind Value pattern [1-9]{1}[0-9]*
source	<code><xs:element name="FigliAffidoPread" type="cm:DatoNP_Type" minOccurs="0"/></code>

element Familiari_Type/Modulo

diagram	
namespace	urn:www.agenziaentrate.gov.it:specificheTecniche:sco:730
type	m730:Modulo_Familiari_Type
children	m730:Coniuge m730:PrimoFiglio m730:Familiari
source	<code><xs:element name="Modulo" type="m730:Modulo_Familiari_Type" minOccurs="0" maxOccurs="unbounded"/></code>

complexType Firma_Dichiarazione_Type

diagram	
namespace	urn:www.agenziaentrate.gov.it:specificheTecniche:sco:730
children	m730:NumeroModelli m730:FirmaDichiarazione m730:OpzioneInformativa m730:SoggettoFiscalmenteCarico
source	<pre> <xs:complexType name="Firma_Dichiarazione_Type"> <xs:sequence> <xs:element name="NumeroModelli" type="cm:DatoNP_Type"/> <xs:element name="FirmaDichiarazione" type="cm:DatoCB_Type" minOccurs="0"/> <xs:element name="OpzioneInformativa" type="cm:DatoCB_Type" minOccurs="0"/> <xs:element name="SoggettoFiscalmenteCarico" type="cm:DatoCB_Type" minOccurs="0"/> </xs:sequence> </xs:complexType> </pre>

element Firma_Dichiarazione_Type/NumeroModelli

diagram	
namespace	urn:www.agenziaentrate.gov.it:specificheTecniche:sco:730
type	DatoNP_Type
facets	Kind Value

	pattern [1-9]{1}[0-9]*
source	<xs:element name="NumeroModelli" type="cm:DatoNP_Type"/>

element **Firma_Dichiarazione_Type/FirmaDichiarazione**

diagram	
namespace	urn:www.agenziaentrate.gov.it:specificheTecniche:sco:730
type	DatoCB_Type
facets	Kind Value pattern [01]
source	<xs:element name="FirmaDichiarazione" type="cm:DatoCB_Type" minOccurs="0"/>

element **Firma_Dichiarazione_Type/OpzioneInformativa**

diagram	
namespace	urn:www.agenziaentrate.gov.it:specificheTecniche:sco:730
type	DatoCB_Type
facets	Kind Value pattern [01]
source	<xs:element name="OpzioneInformativa" type="cm:DatoCB_Type" minOccurs="0"/>

element **Firma_Dichiarazione_Type/SoggettoFiscalmenteCarico**

diagram	
namespace	urn:www.agenziaentrate.gov.it:specificheTecniche:sco:730
type	DatoCB_Type
facets	Kind Value pattern [01]
source	<xs:element name="SoggettoFiscalmenteCarico" type="cm:DatoCB_Type" minOccurs="0"/>

complexType **Fondo_Pensione_Dipendenti_Pubblici_Type**

diagram	
namespace	urn:www.agenziaentrate.gov.it:specificheTecniche:sco:730
children	m730:Contributi m730:QuotaTFR
source	<xs:complexType name="Fondo_Pensione_Dipendenti_Pubblici_Type"> <xs:sequence> <xs:element name="Contributi" type="m730:Contributi_Previdenza_Complementare_Type" minOccurs="0"/> <xs:element name="QuotaTFR" type="cm:DatoNP_Type" minOccurs="0"/> </xs:sequence> </xs:complexType>

element **Fondo_Pensione_Dipendenti_Pubblici_Type/Contributi**

diagram	
namespace	urn:www.agenziaentrate.gov.it:specificheTecniche:sco:730
type	m730:Contributi Previdenza Complementare Type
children	m730:EsclusiDalSostituto m730:NonEsclusiDalSostituto
source	<code><xs:element name="Contributi" type="m730:Contributi_Previdenza_Complementare_Type" minOccurs="0"/></code>

element **Fondo_Pensione_Dipendenti_Pubblici_Type/QuotaTFR**

diagram					
namespace	urn:www.agenziaentrate.gov.it:specificheTecniche:sco:730				
type	DatoNP_Type				
facets	<table border="1"> <thead> <tr> <th>Kind</th> <th>Value</th> </tr> </thead> <tbody> <tr> <td>pattern</td> <td>[1-9]{1}[0-9]*</td> </tr> </tbody> </table>	Kind	Value	pattern	[1-9]{1}[0-9]*
Kind	Value				
pattern	[1-9]{1}[0-9]*				
source	<code><xs:element name="QuotaTFR" type="cm:DatoNP_Type" minOccurs="0"/></code>				

complexType **Frontespizio_730_Type**

diagram	
namespace	urn:www.agenziaentrate.gov.it:specificheTecniche:sco:730
children	m730:SoggettoFiscale m730:DatiAnagrafici m730:StatoCivile m730:ResidenzaAnagrafica m730:DomicilioFiscale01012014 m730:DomicilioFiscale01012015 m730:CasiParticolariAddizionale m730:Firma
source	<pre> <xs:complexType name="Frontespizio_730_Type"> <xs:sequence> <xs:element name="SoggettoFiscale" type="m730:Soggetto_Fiscale_730_Type"/> <xs:element name="DatiAnagrafici" type="sc:Dati_Anagrafici_Type"/> <xs:element name="StatoCivile" type="m730:Stato_Civile_Type" minOccurs="0"/> <xs:element name="ResidenzaAnagrafica" type="m730:Residenza_Anagrafica_730_Type" minOccurs="0"/> </pre>

	<pre> <xs:element name="DomicilioFiscale01012014" type="m730:Domicilio_Fiscale_type"/> <xs:element name="DomicilioFiscale01012015" type="m730:Domicilio_Fiscale_type" minOccurs="0"/> <xs:element name="CasiParticolariAddizionale" type="cm:DatoCB_Type" minOccurs="0"/> <xs:element name="Firma" type="m730:Firma_Dichiarazione_Type"/> </xs:sequence> </xs:complexType> </pre>
--	---

element **Frontespizio_730_Type/SoggettoFiscale**

diagram	
namespace	urn:www.agenziaentrate.gov.it:specificheTecniche:sco:730
type	m730:Soggetto_Fiscale_730_Type
children	m730:CodiceFiscale m730:Email m730:Telefono m730:Cellulare
source	<code><xs:element name="SoggettoFiscale" type="m730:Soggetto_Fiscale_730_Type"/></code>

element **Frontespizio_730_Type/DatiAnagrafici**

diagram	
namespace	urn:www.agenziaentrate.gov.it:specificheTecniche:sco:730
type	Dati_Anagrafici_Type
children	Cognome Nome Sesso DataNascita ComuneNascita ProvinciaNascita
source	<code><xs:element name="DatiAnagrafici" type="sc:Dati_Anagrafici_Type"/></code>

element **Frontespizio_730_Type/StatoCivile**

diagram									
namespace	urn:www.agenziaentrate.gov.it:specificheTecniche:sco:730								
type	m730:Stato Civile Type								
facets	<table border="1"> <thead> <tr> <th>Kind</th> <th>Value</th> </tr> </thead> <tbody> <tr> <td>pattern</td> <td>[1-9]{1}[0-9]*</td> </tr> <tr> <td>enumeration</td> <td>7</td> </tr> <tr> <td>enumeration</td> <td>8</td> </tr> </tbody> </table>	Kind	Value	pattern	[1-9]{1}[0-9]*	enumeration	7	enumeration	8
Kind	Value								
pattern	[1-9]{1}[0-9]*								
enumeration	7								
enumeration	8								
source	<code><xs:element name="StatoCivile" type="m730:Stato_Civile_Type" minOccurs="0"/></code>								

element **Frontespizio_730_Type/ResidenzaAnagrafica**

diagram	
namespace	urn:www.agenziaentrate.gov.it:specificheTecniche:sco:730
type	m730:Residenza Anagrafica 730 Type
children	Comune Provincia CodiceComune Indirizzo Cap DataVariazione m730:Tipologia m730:NumCivico m730:Frazione m730:PrimaPresentazione
source	<code><xs:element name="ResidenzaAnagrafica" type="m730:Residenza_Anagrafica_730_Type" minOccurs="0"/></code>

element **Frontespizio_730_Type/DomicilioFiscale01012014**

diagram	
namespace	urn:www.agenziaentrate.gov.it:specificheTecniche:sco:730
type	m730:Domicilio_Fiscale_type
children	m730:Comune m730:Provincia m730:CodiceComune
source	<code><xs:element name="DomicilioFiscale01012014" type="m730:Domicilio_Fiscale_type"/></code>

element **Frontespizio_730_Type/DomicilioFiscale01012015**

diagram	
namespace	urn:www.agenziaentrate.gov.it:specificheTecniche:sco:730
type	m730:Domicilio_Fiscale_type
children	m730:Comune m730:Provincia m730:CodiceComune
source	<code><xs:element name="DomicilioFiscale01012015" type="m730:Domicilio_Fiscale_type"/></code>

element **Frontespizio_730_Type/CasiParticolariAddizionale**

diagram					
namespace	urn:www.agenziaentrate.gov.it:specificheTecniche:sco:730				
type	DatoCB_Type				
facets	<table border="1"> <thead> <tr> <th>Kind</th> <th>Value</th> </tr> </thead> <tbody> <tr> <td>pattern</td> <td>[01]</td> </tr> </tbody> </table>	Kind	Value	pattern	[01]
Kind	Value				
pattern	[01]				
source	<code><xs:element name="CasiParticolariAddizionale" type="cm:DatoCB_Type" minOccurs="0"/></code>				

element **Frontespizio_730_Type/Firma**

diagram	
namespace	urn:www.agenziaentrate.gov.it:specificheTecniche:sco:730
type	m730:Firma_Dichiarazione_Type
children	m730:NumeroModelli m730:FirmaDichiarazione m730:OpzioneInformativa m730:SoggettoFiscalmenteCarico
source	<code><xs:element name="Firma" type="m730:Firma_Dichiarazione_Type"/></code>

complexType **Frontespizio_Con_Type**

diagram	
namespace	urn:www.agenziaentrate.gov.it:specificheTecniche:sco:730
type	extension of m730:Frontespizio_730_Type
children	m730:SoggettoFiscale m730:DatiAnagrafici m730:StatoCivile m730:ResidenzaAnagrafica m730:DomicilioFiscale01012014 m730:DomicilioFiscale01012015 m730:CasiParticolariAddizionale m730:Firma
source	<code><xs:complexType name="Frontespizio_Con_Type"> <xs:complexContent> <xs:extension base="m730:Frontespizio_730_Type"/> </xs:complexContent> </xs:complexType></code>

complexType **Frontespizio_Dich_Type**

diagram	
namespace	urn:www.agenziaentrate.gov.it:specificheTecniche:sco:730
type	extension of m730:Frontespizio_730_Type
children	m730:SoggettoFiscale m730:DatiAnagrafici m730:StatoCivile m730:ResidenzaAnagrafica m730:DomicilioFiscale01012014 m730:DomicilioFiscale01012015 m730:CasiParticolariAddizionale m730:Firma m730:Rappresentante
source	<pre> <xs:complexType name="Frontespizio_Dich_Type"> <xs:complexContent> <xs:extension base="m730:Frontespizio_730_Type"> <xs:sequence> <xs:element name="Rappresentante" minOccurs="0"> <xs:complexType> <xs:sequence> <xs:element name="SoggettoFiscale" type="m730:Soggetto_Fiscale_730_Type"/> <xs:element name="DatiAnagrafici" type="sc:Dati_Anagrafici_Type"/> <xs:element name="ResidenzaAnagrafica" type="m730:Residenza_Rappresentante_Type" minOccurs="0"/> <xs:element name="Firma" type="cm:DatoCB_Type"/> </xs:sequence> </xs:complexType> </xs:element> </xs:sequence> </xs:extension> </xs:complexContent> </xs:complexType> </pre>

element **Frontespizio_Dich_Type/Rappresentante**

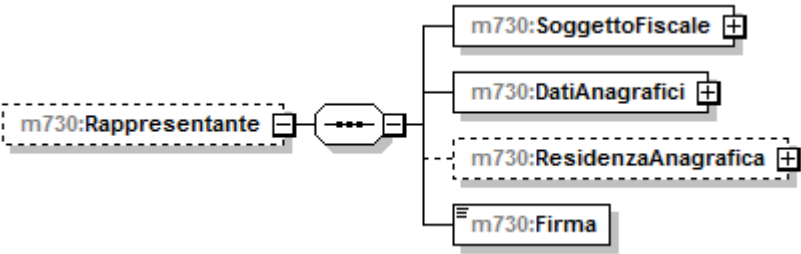
diagram	
namespace	urn:www.agenziaentrate.gov.it:specificheTecniche:sco:730
children	m730:SoggettoFiscale m730:DatiAnagrafici m730:ResidenzaAnagrafica m730:Firma
source	<pre> <xs:element name="Rappresentante" minOccurs="0"> <xs:complexType> <xs:sequence> <xs:element name="SoggettoFiscale" type="m730:Soggetto_Fiscale_730_Type"/> <xs:element name="DatiAnagrafici" type="sc:Dati_Anagrafici_Type"/> <xs:element name="ResidenzaAnagrafica" type="m730:Residenza_Rappresentante_Type" minOccurs="0"/> <xs:element name="Firma" type="cm:DatoCB_Type"/> </xs:sequence> </xs:complexType> </xs:element> </pre>

element **Frontespizio_Dich_Type/Rappresentante/SoggettoFiscale**

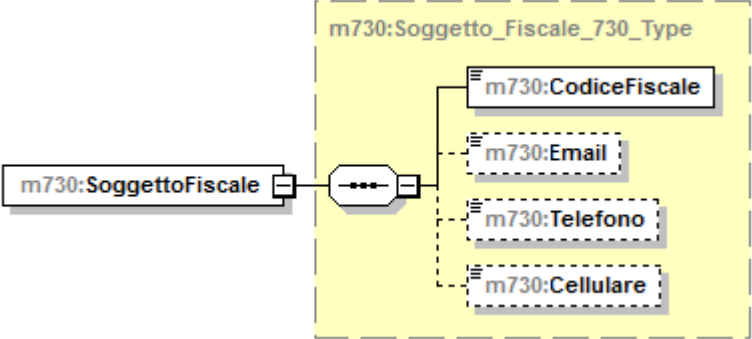
diagram	
namespace	urn:www.agenziaentrate.gov.it:specificheTecniche:sco:730
type	m730:Soggetto_Fiscale_730_Type
children	m730:CodiceFiscale m730:Email m730:Telefono m730:Cellulare
source	<pre> <xs:element name="SoggettoFiscale" type="m730:Soggetto_Fiscale_730_Type"/> </pre>

element **Frontespizio_Dich_Type/Rappresentante/DatiAnagrafici**

diagram	<p>The diagram illustrates the structure of the <code>sc:Dati_Anagrafici_Type</code> element. It is a complex type containing the following elements: <code>Cognome</code>, <code>Nome</code>, <code>Sesso</code>, <code>DataNascita</code>, <code>ComuneNascita</code>, and <code>ProvinciaNascita</code>. The element is connected to <code>m730:DatiAnagrafici</code>.</p>
namespace	urn:www.agenziaentrato.gov.it:specificheTecniche:sco:730
type	Dati_Anagrafici_Type
children	Cognome Nome Sesso DataNascita ComuneNascita ProvinciaNascita
source	<code><xs:element name="DatiAnagrafici" type="sc:Dati_Anagrafici_Type"/></code>

element **Frontespizio_Dich_Type/Rappresentante/ResidenzaAnagrafica**

diagram	<p>The diagram illustrates the structure of the <code>m730:Residenza_Rappresentante_Type</code> element. It is a complex type containing the following elements: <code>Comune</code>, <code>Provincia</code>, <code>CodiceComune</code>, <code>Indirizzo</code>, <code>Cap</code>, <code>m730:Tipologia</code>, <code>m730:NumCivico</code>, and <code>m730:Frazione</code>. The element is connected to <code>m730:ResidenzaAnagrafica</code>.</p>
namespace	urn:www.agenziaentrato.gov.it:specificheTecniche:sco:730
type	m730:Residenza_Rappresentante_Type
children	Comune Provincia CodiceComune Indirizzo Cap m730:Tipologia m730:NumCivico m730:Frazione
source	<code><xs:element name="ResidenzaAnagrafica" type="m730:Residenza_Rappresentante_Type" minOccurs="0"/></code>

element **Frontespizio_Dich_Type/Rappresentante/Firma**

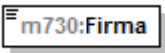
diagram	
namespace	urn:www.agenziaentrate.gov.it:specificheTecniche:sco:730
type	DatoCB_Type
facets	Kind Value pattern [01]
source	<xs:element name="Firma" type="cm:DatoCB_Type"/>

complexType **Fuori_Assistenza_Type**

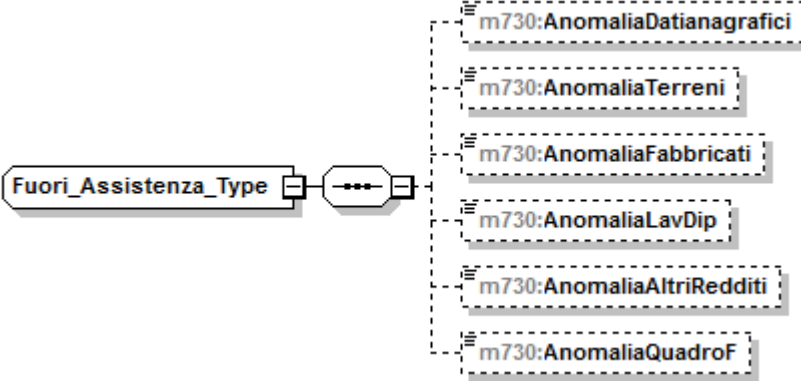
diagram	
namespace	urn:www.agenziaentrate.gov.it:specificheTecniche:sco:730
children	m730:AnomaliaDatianagrafici m730:AnomaliaTerreni m730:AnomaliaFabbricati m730:AnomaliaLavDip m730:AnomaliaAltriRedditi m730:AnomaliaQuadroF
source	<xs:complexType name="Fuori_Assistenza_Type"> <xs:sequence> <xs:element name="AnomaliaDatianagrafici" type="cm:DatoCB_Type" minOccurs="0"/> <xs:element name="AnomaliaTerreni" type="cm:DatoCB_Type" minOccurs="0"/> <xs:element name="AnomaliaFabbricati" type="cm:DatoCB_Type" minOccurs="0"/> <xs:element name="AnomaliaLavDip" type="cm:DatoCB_Type" minOccurs="0"/> <xs:element name="AnomaliaAltriRedditi" type="cm:DatoCB_Type" minOccurs="0"/> <xs:element name="AnomaliaQuadroF" type="cm:DatoCB_Type" minOccurs="0"/> </xs:sequence> </xs:complexType>

element **Fuori_Assistenza_Type/AnomaliaDatianagrafici**

diagram	
namespace	urn:www.agenziaentrate.gov.it:specificheTecniche:sco:730
type	DatoCB_Type
facets	Kind Value pattern [01]
source	<xs:element name="AnomaliaDatianagrafici" type="cm:DatoCB_Type" minOccurs="0"/>

element **Fuori_Assistenza_Type/AnomaliaTerreni**

diagram	
---------	---

namespace	urn:www.agenziaentrate.gov.it:specificheTecniche:sco:730
type	DatoCB_Type
facets	Kind Value pattern [01]
source	<xs:element name="AnomaliaTerreni" type="cm:DatoCB_Type" minOccurs="0"/>

element **Fuori_Assistenza_Type/AnomaliaFabbricati**

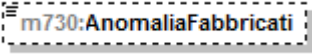
diagram	
namespace	urn:www.agenziaentrate.gov.it:specificheTecniche:sco:730
type	DatoCB_Type
facets	Kind Value pattern [01]
source	<xs:element name="AnomaliaFabbricati" type="cm:DatoCB_Type" minOccurs="0"/>

element **Fuori_Assistenza_Type/AnomaliaLavDip**

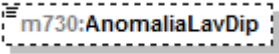
diagram	
namespace	urn:www.agenziaentrate.gov.it:specificheTecniche:sco:730
type	DatoCB_Type
facets	Kind Value pattern [01]
source	<xs:element name="AnomaliaLavDip" type="cm:DatoCB_Type" minOccurs="0"/>

element **Fuori_Assistenza_Type/AnomaliaAltriRedditi**

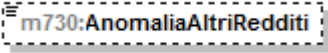
diagram	
namespace	urn:www.agenziaentrate.gov.it:specificheTecniche:sco:730
type	DatoCB_Type
facets	Kind Value pattern [01]
source	<xs:element name="AnomaliaAltriRedditi" type="cm:DatoCB_Type" minOccurs="0"/>

element **Fuori_Assistenza_Type/AnomaliaQuadroF**

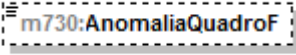
diagram	
namespace	urn:www.agenziaentrate.gov.it:specificheTecniche:sco:730
type	DatoCB_Type
facets	Kind Value pattern [01]
source	<xs:element name="AnomaliaQuadroF" type="cm:DatoCB_Type" minOccurs="0"/>

complexType **Giorni_Percentuale_Type**

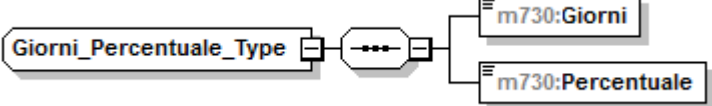
diagram	
namespace	urn:www.agenziaentrate.gov.it:specificheTecniche:sco:730
children	m730:Giorni m730:Percentuale
source	<pre><xs:complexType name="Giorni_Percentuale_Type"> <xs:sequence> <xs:element name="Giorni" type="cm:DatoNP_Type"/> <xs:element name="Percentuale" type="cm:DatoPC_Type"/> </xs:sequence> </xs:complexType></pre>

element **Giorni_Percentuale_Type/Giorni**

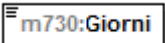
diagram	
namespace	urn:www.agenziaentrate.gov.it:specificheTecniche:sco:730
type	DatoNP_Type
facets	Kind Value pattern [1-9]{1}[0-9]*
source	<pre><xs:element name="Giorni" type="cm:DatoNP_Type"/></pre>

element **Giorni_Percentuale_Type/Percentuale**

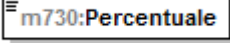
diagram	
namespace	urn:www.agenziaentrate.gov.it:specificheTecniche:sco:730
type	DatoPC_Type
facets	Kind Value pattern [0-9]?[0-9](,\d{1,3})? 100(,0{1,3})?
source	<pre><xs:element name="Percentuale" type="cm:DatoPC_Type"/></pre>

complexType **Importi_Rimborsare730-4_Type**

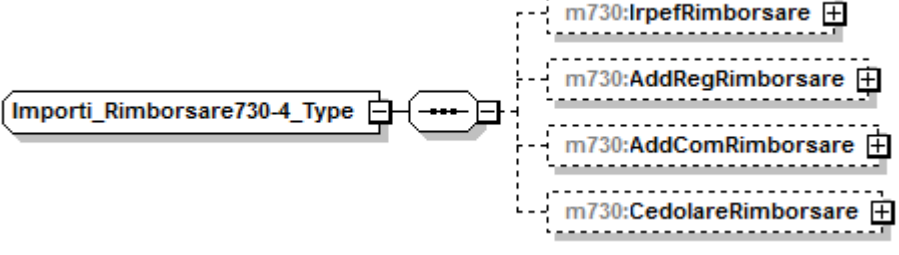
diagram	
namespace	urn:www.agenziaentrate.gov.it:specificheTecniche:sco:730
children	m730:IrpefRimborsare m730:AddRegRimborsare m730:AddComRimborsare m730:CedolareRimborsare
source	<pre><xs:complexType name="Importi_Rimborsare730-4_Type"> <xs:sequence> <xs:element name="IrpefRimborsare" type="m730:Importo_730-4" minOccurs="0"/> <xs:element name="AddRegRimborsare" minOccurs="0"/> </xs:sequence> </xs:complexType></pre>

	<pre> <xs:complexType> <xs:sequence> <xs:element name="ImportoAddizionale" type="m730:Importo_730-4"/> <xs:element name="CodiceRegioneDichiarante" type="sc:Codice_Regione_Type" minOccurs="0"/> <xs:element name="CodiceRegioneConiuge" type="sc:Codice_Regione_Type" minOccurs="0"/> </xs:sequence> </xs:complexType> </xs:element> <xs:element name="AddComRimborsare" minOccurs="0"> <xs:complexType> <xs:sequence> <xs:element name="ImportoAddizionale" type="m730:Importo_730-4"/> <xs:element name="CodiceComuneDichiarante" type="cm:DatoAN_Type" minOccurs="0"/> <xs:element name="CodiceComuneConiuge" type="cm:DatoAN_Type" minOccurs="0"/> </xs:sequence> </xs:complexType> </xs:element> <xs:element name="CedolareRimborsare" type="m730:Importo_730-4" minOccurs="0"/> </xs:sequence> </xs:complexType> </pre>
--	--

element **Importi_Rimborsare730-4_Type/IrpefRimborsare**

diagram	
namespace	urn:www.agenziaentrate.gov.it:specificheTecniche:sco:730
type	m730:Importo_730-4
children	m730:ImportoDichiarante m730:ImportoConiuge m730:ImportoTotale
source	<code><xs:element name="IrpefRimborsare" type="m730:Importo_730-4" minOccurs="0"/></code>

element **Importi_Rimborsare730-4_Type/AddRegRimborsare**

diagram	
namespace	urn:www.agenziaentrate.gov.it:specificheTecniche:sco:730
children	m730:ImportoAddizionale m730:CodiceRegioneDichiarante m730:CodiceRegioneConiuge
source	<pre> <xs:element name="AddRegRimborsare" minOccurs="0"> <xs:complexType> <xs:sequence> <xs:element name="ImportoAddizionale" type="m730:Importo_730-4"/> <xs:element name="CodiceRegioneDichiarante" type="sc:Codice_Regione_Type" minOccurs="0"/> <xs:element name="CodiceRegioneConiuge" type="sc:Codice_Regione_Type" minOccurs="0"/> </xs:sequence> </xs:complexType> </xs:element> </pre>

element **Importi_Rimborsare730-4_Type/AddRegRimborsare/ImportoAddizionale**

diagram	
namespace	urn:www.agenziaentrate.gov.it:specificheTecniche:sco:730
type	m730:Importo_730-4
children	m730:ImportoDichiarante m730:ImportoConiuge m730:ImportoTotale
source	<xs:element name="ImportoAddizionale" type="m730:Importo_730-4"/>

element **Importi_Rimborsare730-4_Type/AddRegRimborsare/CodiceRegioneDichiarante**

diagram																																															
namespace	urn:www.agenziaentrate.gov.it:specificheTecniche:sco:730																																														
type	Codice Regione Type																																														
facets	<table border="1"> <thead> <tr> <th>Kind</th> <th>Value</th> </tr> </thead> <tbody> <tr> <td>pattern</td> <td>([0-9A-Z-])&quot;{1}([0-9A-Z&amp;:] '-\., /'°\^\\(\) À É Ï Ò Ù Û &quot; \N { +)*</td> </tr> <tr><td>enumeration</td><td>1</td></tr> <tr><td>enumeration</td><td>2</td></tr> <tr><td>enumeration</td><td>3</td></tr> <tr><td>enumeration</td><td>4</td></tr> <tr><td>enumeration</td><td>5</td></tr> <tr><td>enumeration</td><td>6</td></tr> <tr><td>enumeration</td><td>7</td></tr> <tr><td>enumeration</td><td>8</td></tr> <tr><td>enumeration</td><td>9</td></tr> <tr><td>enumeration</td><td>10</td></tr> <tr><td>enumeration</td><td>11</td></tr> <tr><td>enumeration</td><td>12</td></tr> <tr><td>enumeration</td><td>13</td></tr> <tr><td>enumeration</td><td>14</td></tr> <tr><td>enumeration</td><td>15</td></tr> <tr><td>enumeration</td><td>16</td></tr> <tr><td>enumeration</td><td>17</td></tr> <tr><td>enumeration</td><td>18</td></tr> <tr><td>enumeration</td><td>19</td></tr> <tr><td>enumeration</td><td>20</td></tr> <tr><td>enumeration</td><td>21</td></tr> </tbody> </table>	Kind	Value	pattern	([0-9A-Z-])"{1}([0-9A-Z&:] '-\., /'°\^\\(\) À É Ï Ò Ù Û " \N { +)*	enumeration	1	enumeration	2	enumeration	3	enumeration	4	enumeration	5	enumeration	6	enumeration	7	enumeration	8	enumeration	9	enumeration	10	enumeration	11	enumeration	12	enumeration	13	enumeration	14	enumeration	15	enumeration	16	enumeration	17	enumeration	18	enumeration	19	enumeration	20	enumeration	21
Kind	Value																																														
pattern	([0-9A-Z-])"{1}([0-9A-Z&:] '-\., /'°\^\\(\) À É Ï Ò Ù Û " \N { +)*																																														
enumeration	1																																														
enumeration	2																																														
enumeration	3																																														
enumeration	4																																														
enumeration	5																																														
enumeration	6																																														
enumeration	7																																														
enumeration	8																																														
enumeration	9																																														
enumeration	10																																														
enumeration	11																																														
enumeration	12																																														
enumeration	13																																														
enumeration	14																																														
enumeration	15																																														
enumeration	16																																														
enumeration	17																																														
enumeration	18																																														
enumeration	19																																														
enumeration	20																																														
enumeration	21																																														
source	<xs:element name="CodiceRegioneDichiarante" type="sc:Codice_Regione_Type" minOccurs="0"/>																																														

element **Importi_Rimborsare730-4_Type/AddRegRimborsare/CodiceRegioneConiuge**

diagram	
namespace	urn:www.agenziaentrate.gov.it:specificheTecniche:sco:730
type	Codice Regione Type

facets	Kind	Value
	pattern	([0-9A-Z-]]"){1}([0-9A-Z&]] ' \\. / ° \\^\\(\\) À É Ê Ï Ò Ù Û " \\ \\ \\ +)*
	enumeration	1
	enumeration	2
	enumeration	3
	enumeration	4
	enumeration	5
	enumeration	6
	enumeration	7
	enumeration	8
	enumeration	9
	enumeration	10
	enumeration	11
	enumeration	12
	enumeration	13
	enumeration	14
	enumeration	15
	enumeration	16
	enumeration	17
	enumeration	18
	enumeration	19
enumeration	20	
enumeration	21	
source	<code><xs:element name="CodiceRegioneConiuge" type="sc:Codice_Regione_Type" minOccurs="0"/></code>	

element **Importi_Rimborsare730-4_Type/AddComRimborsare**

diagram	
namespace	urn:www.agenziaentrate.gov.it:specificheTecniche:sco:730
children	m730:ImportoAddizionale m730:CodiceComuneDichiarante m730:CodiceComuneConiuge
source	<pre> <xs:element name="AddComRimborsare" minOccurs="0"> <xs:complexType> <xs:sequence> <xs:element name="ImportoAddizionale" type="m730:Importo_730-4"/> <xs:element name="CodiceComuneDichiarante" type="cm:DatoAN_Type" minOccurs="0"/> <xs:element name="CodiceComuneConiuge" type="cm:DatoAN_Type" minOccurs="0"/> </xs:sequence> </xs:complexType> </xs:element> </pre>

element **Importi_Rimborsare730-4_Type/AddComRimborsare/ImportoAddizionale**

diagram	
namespace	urn:www.agenziaentrate.gov.it:specificheTecniche:sco:730
type	m730:Importo_730-4

children	m730:ImportoDichiarante m730:ImportoConiuge m730:ImportoTotale
source	<xs:element name="ImportoAddizionale" type="m730:Importo_730-4"/>

element **Importi_Rimborsare730-4_Type/AddComRimborsare/CodiceComuneDichiarante**

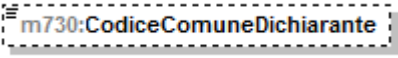
diagram	
namespace	urn:www.agenziaentrate.gov.it:specificheTecniche:sco:730
type	DatoAN_Type
facets	Kind Value pattern ([0-9A-Z-] \"){1}([0-9A-Z&] " - \., / "^\(\\) À É È Ì Ò Ù Û " \\ /+)*
source	<xs:element name="CodiceComuneDichiarante" type="cm:DatoAN_Type" minOccurs="0"/>

element **Importi_Rimborsare730-4_Type/AddComRimborsare/CodiceComuneConiuge**

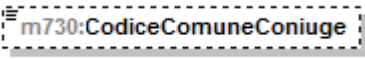
diagram	
namespace	urn:www.agenziaentrate.gov.it:specificheTecniche:sco:730
type	DatoAN_Type
facets	Kind Value pattern ([0-9A-Z-] \"){1}([0-9A-Z&] " - \., / "^\(\\) À É È Ì Ò Ù Û " \\ /+)*
source	<xs:element name="CodiceComuneConiuge" type="cm:DatoAN_Type" minOccurs="0"/>

element **Importi_Rimborsare730-4_Type/CedolareRimborsare**

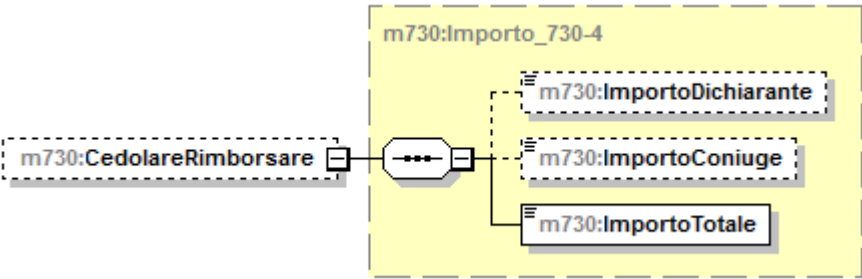
diagram	
namespace	urn:www.agenziaentrate.gov.it:specificheTecniche:sco:730
type	m730:Importo_730-4
children	m730:ImportoDichiarante m730:ImportoConiuge m730:ImportoTotale
source	<xs:element name="CedolareRimborsare" type="m730:Importo_730-4" minOccurs="0"/>

complexType **Importi_Rimborsare_730-4_Integrativo_Type**

diagram	
namespace	urn:www.agenziaentrate.gov.it:specificheTecniche:sco:730
type	extension of m730:Importi_Rimborsare730-4_Type
children	m730:IrpefRimborsare m730:AddRegRimborsare m730:AddComRimborsare m730:CedolareRimborsare m730:Tassazione SepRimborsare m730:IncrementoProduttivita m730:ContributoSolidarieta
source	<pre> <xs:complexType name="Importi_Rimborsare_730-4_Integrativo_Type"> <xs:complexContent> <xs:extension base="m730:Importi_Rimborsare730-4_Type"> <xs:sequence> <xs:element name="TassazioneSepRimborsare" type="m730:Importo_730-4" minOccurs="0"/> <xs:element name="IncrementoProduttivita" type="m730:Importo_730-4" minOccurs="0"/> <xs:element name="ContributoSolidarieta" type="m730:Importo_730-4" minOccurs="0"/> </xs:sequence> </xs:extension> </xs:complexContent> </xs:complexType> </pre>

element **Importi_Rimborsare_730-4_Integrativo_Type/TassazioneSepRimborsare**

diagram	
namespace	urn:www.agenziaentrate.gov.it:specificheTecniche:sco:730
type	m730:Importo_730-4
children	m730:ImportoDichiarante m730:ImportoConiuge m730:ImportoTotale
source	<pre> <xs:element name="TassazioneSepRimborsare" type="m730:Importo_730-4" minOccurs="0"/> </pre>

element **Importi_Rimborsare_730-4_Integrativo_Type/IncrementoProduttivita**

diagram	<p>The diagram illustrates the structure of the <code>m730:IncrementoProduttivita</code> element. It is connected to a container element <code>m730:Importo_730-4</code>. This container contains three sub-elements: <code>m730:ImportoDichiarante</code>, <code>m730:ImportoConiuge</code>, and <code>m730:ImportoTotale</code>.</p>
namespace	urn:www.agenziaentrate.gov.it:specificheTecniche:sco:730
type	m730:Importo_730-4
children	m730:ImportoDichiarante m730:ImportoConiuge m730:ImportoTotale
source	<code><xs:element name="IncrementoProduttivita" type="m730:Importo_730-4" minOccurs="0"/></code>

element **Importi_Rimborsare_730-4_Integrativo_Type/ContributoSolidarieta**

diagram	<p>The diagram illustrates the structure of the <code>m730:ContributoSolidarieta</code> element. It is connected to a container element <code>m730:Importo_730-4</code>. This container contains three sub-elements: <code>m730:ImportoDichiarante</code>, <code>m730:ImportoConiuge</code>, and <code>m730:ImportoTotale</code>.</p>
namespace	urn:www.agenziaentrate.gov.it:specificheTecniche:sco:730
type	m730:Importo_730-4
children	m730:ImportoDichiarante m730:ImportoConiuge m730:ImportoTotale
source	<code><xs:element name="ContributoSolidarieta" type="m730:Importo_730-4" minOccurs="0"/></code>

complexType **ImportiTrattenerere730-4**

<p>diagram</p>	
<p>namespace</p>	<p>urn:www.agenziaentrate.gov.it:specificheTecniche:sco:730</p>
<p>children</p>	<p>m730:IrpefTrattenerere m730:AddRegTrattenerere m730:AddComTrattenerere m730:IrpefPrimaRataTrattenerere m730:IrpefSecondaRataTrattenerere m730:TassSepAccontoTrattenerere m730:AddComAccontoTrattenerere m730:IncrProduitTrattenerere m730:CedolareTrattenerere m730:CedolarePrimaRataTratte... m730:CedolareSecondaRataTra... m730:ContribSolidTrattenerere</p>
<p>source</p>	<pre> <xs:complexType name="ImportiTrattenerere730-4"> <xs:sequence> <xs:element name="IrpefTrattenerere" type="m730:Importo_730-4" minOccurs="0"/> <xs:element name="AddRegTrattenerere" minOccurs="0"> <xs:complexType> <xs:sequence> <xs:element name="ImportoAddizionale" type="m730:Importo_730-4"/> <xs:element name="CodiceRegioneDichiarante" type="sc:Codice_Regione_Type" minOccurs="0"/> <xs:element name="CodiceRegioneConiuge" type="sc:Codice_Regione_Type" minOccurs="0"/> </xs:sequence> </xs:complexType> </xs:element> <xs:element name="AddComTrattenerere" minOccurs="0"> <xs:complexType> <xs:sequence> <xs:element name="ImportoAddizionale" type="m730:Importo_730-4"/> <xs:element name="CodiceComuneDichiarante" type="cm:DatoAN_Type" minOccurs="0"/> <xs:element name="CodiceComuneConiuge" type="cm:DatoAN_Type" minOccurs="0"/> </xs:sequence> </xs:complexType> </xs:element> <xs:element name="IrpefPrimaRataTrattenerere" type="m730:Importo_730-4" minOccurs="0"/> <xs:element name="IrpefSecondaRataTrattenerere" type="m730:Importo_730-4" minOccurs="0"/> <xs:element name="TassSepAccontoTrattenerere" type="m730:Importo_730-4" minOccurs="0"/> <xs:element name="AddComAccontoTrattenerere" minOccurs="0"> <xs:complexType> <xs:sequence> <xs:element name="ImportoAddizionale" type="m730:Importo_730-4"/> </xs:sequence> </xs:complexType> </xs:element> </xs:sequence> </xs:complexType> </pre>

	<pre> <xs:element name="CodiceComuneDichiarante" type="cm:DatoAN_Type" minOccurs="0"/> <xs:element name="CodiceComuneConiuge" type="cm:DatoAN_Type" minOccurs="0"/> </xs:sequence> </xs:complexType> </xs:element> <xs:element name="IncrProduTtrattenerere" type="m730:Importo_730-4" minOccurs="0"/> <xs:element name="CedolareTrattenerere" type="m730:Importo_730-4" minOccurs="0"/> <xs:element name="CedolarePrimaRataTrattenerere" type="m730:Importo_730-4" minOccurs="0"/> <xs:element name="CedolareSecondaRataTrattenerere" type="m730:Importo_730-4" minOccurs="0"/> <xs:element name="ContribSolidTrattenerere" type="m730:Importo_730-4" minOccurs="0"/> </xs:sequence> </xs:complexType> </pre>
--	--

element **ImportiTrattenerere730-4/IrpefTrattenerere**

diagram	
namespace	urn:www.agenziaentrate.gov.it:specificheTecniche:sco:730
type	m730:Importo_730-4
children	m730:ImportoDichiarante m730:ImportoConiuge m730:ImportoTotale
source	<pre><xs:element name="IrpefTrattenerere" type="m730:Importo_730-4" minOccurs="0"/></pre>

element **ImportiTrattenerere730-4/AddRegTrattenerere**

diagram	
namespace	urn:www.agenziaentrate.gov.it:specificheTecniche:sco:730
children	m730:ImportoAddizionale m730:CodiceRegioneDichiarante m730:CodiceRegioneConiuge
source	<pre> <xs:element name="AddRegTrattenerere" minOccurs="0"> <xs:complexType> <xs:sequence> <xs:element name="ImportoAddizionale" type="m730:Importo_730-4"/> <xs:element name="CodiceRegioneDichiarante" type="sc:Codice_Regione_Type" minOccurs="0"/> <xs:element name="CodiceRegioneConiuge" type="sc:Codice_Regione_Type" minOccurs="0"/> </xs:sequence> </xs:complexType> </xs:element> </pre>

	enumeration 2
	enumeration 3
	enumeration 4
	enumeration 5
	enumeration 6
	enumeration 7
	enumeration 8
	enumeration 9
	enumeration 10
	enumeration 11
	enumeration 12
	enumeration 13
	enumeration 14
	enumeration 15
	enumeration 16
	enumeration 17
	enumeration 18
	enumeration 19
	enumeration 20
	enumeration 21
source	<xs:element name="CodiceRegioneConiuge" type="sc:Codice_Regione_Type" minOccurs="0"/>

element **ImportiTrattener730-4/AddComTrattener**

diagram	
namespace	urn:www.agenziaentrate.gov.it:specificheTecniche:sco:730
children	m730:ImportoAddizionale m730:CodiceComuneDichiarante m730:CodiceComuneConiuge
source	<pre><xs:element name="AddComTrattener" minOccurs="0"> <xs:complexType> <xs:sequence> <xs:element name="ImportoAddizionale" type="m730:Importo_730-4"/> <xs:element name="CodiceComuneDichiarante" type="cm:DatoAN_Type" minOccurs="0"/> <xs:element name="CodiceComuneConiuge" type="cm:DatoAN_Type" minOccurs="0"/> </xs:sequence> </xs:complexType> </xs:element></pre>

element **ImportiTrattener730-4/AddComTrattener/ImportoAddizionale**

diagram	
namespace	urn:www.agenziaentrate.gov.it:specificheTecniche:sco:730
type	m730:Importo_730-4
children	m730:ImportoDichiarante m730:ImportoConiuge m730:ImportoTotale

source	<xs:element name="ImportoAddizionale" type="m730:Importo_730-4"/>
--------	---

element **ImportiTrattenerere730-4/AddComTrattenerere/CodiceComuneDichiarante**

diagram	
namespace	urn:www.agenziaentrate.gov.it:specificheTecniche:sco:730
type	DatoAN_Type
facets	Kind Value pattern ([0-9A-Z-] \"){1}([0-9A-Z&:] ' - \., / ° ^\(\\ \\) À È É Ì Ò Ù Û " \\ \\ \\ +)*
source	<xs:element name="CodiceComuneDichiarante" type="cm:DatoAN_Type" minOccurs="0"/>

element **ImportiTrattenerere730-4/AddComTrattenerere/CodiceComuneConiuge**

diagram	
namespace	urn:www.agenziaentrate.gov.it:specificheTecniche:sco:730
type	DatoAN_Type
facets	Kind Value pattern ([0-9A-Z-] \"){1}([0-9A-Z&:] ' - \., / ° ^\(\\ \\ \\) À È É Ì Ò Ù Û " \\ \\ \\ +)*
source	<xs:element name="CodiceComuneConiuge" type="cm:DatoAN_Type" minOccurs="0"/>

element **ImportiTrattenerere730-4/IrpefPrimaRataTrattenerere**

diagram	
namespace	urn:www.agenziaentrate.gov.it:specificheTecniche:sco:730
type	m730:Importo_730-4
children	m730:ImportoDichiarante m730:ImportoConiuge m730:ImportoTotale
source	<xs:element name="IrpefPrimaRataTrattenerere" type="m730:Importo_730-4" minOccurs="0"/>

element **ImportiTrattenerere730-4/IrpefSecondaRataTrattenerere**

diagram	
namespace	urn:www.agenziaentrate.gov.it:specificheTecniche:sco:730
type	m730:Importo_730-4
children	m730:ImportoDichiarante m730:ImportoConiuge m730:ImportoTotale
source	<xs:element name="IrpefSecondaRataTratten..." type="m730:Importo_730-4" minOccurs="0"/>

namespace	urn:www.agenziaentrate.gov.it:specificheTecniche:sco:730
type	m730:Importo_730-4
children	m730:ImportoDichiarante m730:ImportoConiuge m730:ImportoTotale
source	<xs:element name="IrpefSecondaRataTrattenerere" type="m730:Importo_730-4" minOccurs="0"/>

element **ImportiTrattenerere730-4/TassSepAccontoTrattenerere**

diagram	
namespace	urn:www.agenziaentrate.gov.it:specificheTecniche:sco:730
type	m730:Importo_730-4
children	m730:ImportoDichiarante m730:ImportoConiuge m730:ImportoTotale
source	<xs:element name="TassSepAccontoTrattenerere" type="m730:Importo_730-4" minOccurs="0"/>

element **ImportiTrattenerere730-4/AddComAccontoTrattenerere**

diagram	
namespace	urn:www.agenziaentrate.gov.it:specificheTecniche:sco:730
children	m730:ImportoAddizionale m730:CodiceComuneDichiarante m730:CodiceComuneConiuge
source	<pre><xs:element name="AddComAccontoTrattenerere" minOccurs="0"> <xs:complexType> <xs:sequence> <xs:element name="ImportoAddizionale" type="m730:Importo_730-4"/> <xs:element name="CodiceComuneDichiarante" type="cm:DatoAN_Type" minOccurs="0"/> <xs:element name="CodiceComuneConiuge" type="cm:DatoAN_Type" minOccurs="0"/> </xs:sequence> </xs:complexType> </xs:element></pre>

children	m730:ImportoDichiarante m730:ImportoConiuge m730:ImportoTotale
source	<code><xs:element name="IncrProdutTrattenerere" type="m730:Importo_730-4" minOccurs="0"/></code>

element **ImportiTrattenerere730-4/CedolareTrattenerere**

diagram	
namespace	urn:www.agenziaentrate.gov.it:specificheTecniche:sco:730
type	m730:Importo_730-4
children	m730:ImportoDichiarante m730:ImportoConiuge m730:ImportoTotale
source	<code><xs:element name="CedolareTrattenerere" type="m730:Importo_730-4" minOccurs="0"/></code>

element **ImportiTrattenerere730-4/CedolarePrimaRataTrattenerere**

diagram	
namespace	urn:www.agenziaentrate.gov.it:specificheTecniche:sco:730
type	m730:Importo_730-4
children	m730:ImportoDichiarante m730:ImportoConiuge m730:ImportoTotale
source	<code><xs:element name="CedolarePrimaRataTrattenerere" type="m730:Importo_730-4" minOccurs="0"/></code>

element **ImportiTrattenerere730-4/CedolareSecondaRataTrattenerere**

diagram	
namespace	urn:www.agenziaentrate.gov.it:specificheTecniche:sco:730
type	m730:Importo_730-4

children	m730:ImportoDichiarante m730:ImportoConiuge m730:ImportoTotale
source	<code><xs:element name="CedolareSecondaRataTrattenerere" type="m730:Importo_730-4" minOccurs="0"/></code>

element **ImportiTrattenerere730-4/ContribSolidTrattenerere**

diagram	
namespace	urn:www.agenziaentrate.gov.it:specificheTecniche:sco:730
type	m730:Importo_730-4
children	m730:ImportoDichiarante m730:ImportoConiuge m730:ImportoTotale
source	<code><xs:element name="ContribSolidTrattenerere" type="m730:Importo_730-4" minOccurs="0"/></code>

complexType **Importo_730-4**

diagram	
namespace	urn:www.agenziaentrate.gov.it:specificheTecniche:sco:730
children	m730:ImportoDichiarante m730:ImportoConiuge m730:ImportoTotale
source	<pre> <xs:complexType name="Importo_730-4"> <xs:sequence> <xs:element name="ImportoDichiarante" type="cm:DatoNP_Type" minOccurs="0"/> <xs:element name="ImportoConiuge" type="cm:DatoNP_Type" minOccurs="0"/> <xs:element name="ImportoTotale" type="cm:DatoNP_Type"/> </xs:sequence> </xs:complexType> </pre>

element **Importo_730-4/ImportoDichiarante**

diagram					
namespace	urn:www.agenziaentrate.gov.it:specificheTecniche:sco:730				
type	DatoNP_Type				
facets	<table border="1"> <thead> <tr> <th>Kind</th> <th>Value</th> </tr> </thead> <tbody> <tr> <td>pattern</td> <td>[1-9]{1}[0-9]*</td> </tr> </tbody> </table>	Kind	Value	pattern	[1-9]{1}[0-9]*
Kind	Value				
pattern	[1-9]{1}[0-9]*				
source	<code><xs:element name="ImportoDichiarante" type="cm:DatoNP_Type" minOccurs="0"/></code>				

element **Importo_730-4/ImportoConiuge**

diagram					
namespace	urn:www.agenziaentrate.gov.it:specificheTecniche:sco:730				
type	DatoNP_Type				
facets	<table border="1"> <tr> <td>Kind</td> <td>Value</td> </tr> <tr> <td>pattern</td> <td>[1-9]{1}[0-9]*</td> </tr> </table>	Kind	Value	pattern	[1-9]{1}[0-9]*
Kind	Value				
pattern	[1-9]{1}[0-9]*				
source	<code><xs:element name="ImportoConiuge" type="cm:DatoNP_Type" minOccurs="0"/></code>				

element **Importo_730-4/ImportoTotale**

diagram					
namespace	urn:www.agenziaentrate.gov.it:specificheTecniche:sco:730				
type	DatoNP_Type				
facets	<table border="1"> <tr> <td>Kind</td> <td>Value</td> </tr> <tr> <td>pattern</td> <td>[1-9]{1}[0-9]*</td> </tr> </table>	Kind	Value	pattern	[1-9]{1}[0-9]*
Kind	Value				
pattern	[1-9]{1}[0-9]*				
source	<code><xs:element name="ImportoTotale" type="cm:DatoNP_Type"/></code>				

complexType **Imposta_Lorda_Type**

diagram	
namespace	urn:www.agenziaentrate.gov.it:specificheTecniche:sco:730
children	m730:RedditoComplessivo m730:DeduzioneAbitazPrincipale m730:OneriDeducibili m730:RedditoImponibile m730:CompensiAttSport m730:ImportoImpostaLorda
source	<code><xs:complexType name="Imposta_Lorda_Type"> <xs:sequence> <xs:element name="RedditoComplessivo" type="cm:DatoNP_Type" minOccurs="0"/> <xs:element name="DeduzioneAbitazPrincipale" type="cm:DatoNP_Type" minOccurs="0"/> <xs:element name="OneriDeducibili" type="cm:DatoNP_Type" minOccurs="0"/> <xs:element name="RedditoImponibile" type="cm:DatoNP_Type" minOccurs="0"/> <xs:element name="CompensiAttSport" type="cm:DatoNP_Type" minOccurs="0"/> <xs:element name="ImportoImpostaLorda" type="cm:DatoNP_Type" minOccurs="0"/> </xs:sequence> </xs:complexType></code>

element **Imposta_Lorda_Type/RedditoComplessivo**

diagram	
---------	--

namespace	urn:www.agenziaentrate.gov.it:specificheTecniche:sco:730
type	DatoNP_Type
facets	Kind Value pattern [1-9]{1}[0-9]*
source	<xs:element name="RedditoComplessivo" type="cm:DatoNP_Type" minOccurs="0"/>

element Imposta_Lorda_Type/DeduzioneAbitazPrincipale

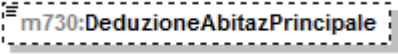
diagram	
namespace	urn:www.agenziaentrate.gov.it:specificheTecniche:sco:730
type	DatoNP_Type
facets	Kind Value pattern [1-9]{1}[0-9]*
source	<xs:element name="DeduzioneAbitazPrincipale" type="cm:DatoNP_Type" minOccurs="0"/>

element Imposta_Lorda_Type/OneriDeducibili

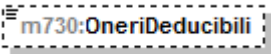
diagram	
namespace	urn:www.agenziaentrate.gov.it:specificheTecniche:sco:730
type	DatoNP_Type
facets	Kind Value pattern [1-9]{1}[0-9]*
source	<xs:element name="OneriDeducibili" type="cm:DatoNP_Type" minOccurs="0"/>

element Imposta_Lorda_Type/RedditoImponibile

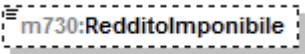
diagram	
namespace	urn:www.agenziaentrate.gov.it:specificheTecniche:sco:730
type	DatoNP_Type
facets	Kind Value pattern [1-9]{1}[0-9]*
source	<xs:element name="RedditoImponibile" type="cm:DatoNP_Type" minOccurs="0"/>

element Imposta_Lorda_Type/CompensiAttSport

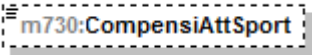
diagram	
namespace	urn:www.agenziaentrate.gov.it:specificheTecniche:sco:730
type	DatoNP_Type
facets	Kind Value pattern [1-9]{1}[0-9]*
source	<xs:element name="CompensiAttSport" type="cm:DatoNP_Type" minOccurs="0"/>

element **Imposta_Lorda_Type/ImportoImpostaLorda**

diagram	
namespace	urn:www.agenziaentrate.gov.it:specificheTecniche:sco:730
type	DatoNP_Type
facets	Kind Value pattern [1-9]{1}[0-9]*
source	<xs:element name="ImportoImpostaLorda" type="cm:DatoNP_Type" minOccurs="0"/>

complexType **Imposta_Netta_Type**

diagram	
namespace	urn:www.agenziaentrate.gov.it:specificheTecniche:sco:730
children	m730:ImportoImpostaNetta m730:CredAltriSisma m730:CredAbitazSisma m730:CredImpEstere m730:CredErogCultura m730:CredCanNonPerc m730:CredDetrazIncapienti m730:Ritenute m730:Differenza m730:EccedenzaIrpef m730:AccontiVersati m730:RestituzioneBonus m730:CredRimborsatiSost m730:BonusIrpefSpettante m730:BonusIrpefRiconosciuto m730:RestituzioneBonusIrpef
source	<xs:complexType name="Imposta_Netta_Type"> <xs:sequence> <xs:element name="ImportoImpostaNetta" type="cm:DatoNP_Type" minOccurs="0"/>

	<pre> <xs:element name="CredAltriSisma" type="cm:DatoNP_Type" minOccurs="0"/> <xs:element name="CredAbitazSisma" type="cm:DatoNP_Type" minOccurs="0"/> <xs:element name="CredImpEstere" type="cm:DatoNP_Type" minOccurs="0"/> <xs:element name="CredErogCultura" type="cm:DatoNP_Type" minOccurs="0"/> <xs:element name="CredCanNonPerc" type="cm:DatoNP_Type" minOccurs="0"/> <xs:element name="CredDetrazIncapienti" type="cm:DatoNP_Type" minOccurs="0"/> <xs:element name="Ritenute" type="cm:DatoNP_Type" minOccurs="0"/> <xs:element name="Differenza" type="cm:DatoNU_Type" minOccurs="0"/> <xs:element name="EccedenzaIrpef" type="cm:DatoNU_Type" minOccurs="0"/> <xs:element name="AccontiVersati" type="cm:DatoNP_Type" minOccurs="0"/> <xs:element name="RestituzioneBonus" type="cm:DatoNP_Type" minOccurs="0"/> <xs:element name="CredRimborsatiSost" type="cm:DatoNP_Type" minOccurs="0"/> <xs:element name="BonusIrpefSpettante" type="cm:DatoNP_Type" minOccurs="0"/> <xs:element name="BonusIrpefRiconosciuto" type="cm:DatoNP_Type" minOccurs="0"/> <xs:element name="RestituzioneBonusIrpef" type="cm:DatoNP_Type" minOccurs="0"/> </xs:sequence> </xs:complexType> </pre>
--	--

element **Imposta_Netta_Type/ImportoImpostaNetta**

diagram					
namespace	urn:www.agenziaentrate.gov.it:specificheTecniche:sco:730				
type	DatoNP_Type				
facets	<table border="1"> <thead> <tr> <th>Kind</th> <th>Value</th> </tr> </thead> <tbody> <tr> <td>pattern</td> <td>[1-9]{1}[0-9]*</td> </tr> </tbody> </table>	Kind	Value	pattern	[1-9]{1}[0-9]*
Kind	Value				
pattern	[1-9]{1}[0-9]*				
source	<code><xs:element name="ImportoImpostaNetta" type="cm:DatoNP_Type" minOccurs="0"/></code>				

element **Imposta_Netta_Type/CredAltriSisma**

diagram					
namespace	urn:www.agenziaentrate.gov.it:specificheTecniche:sco:730				
type	DatoNP_Type				
facets	<table border="1"> <thead> <tr> <th>Kind</th> <th>Value</th> </tr> </thead> <tbody> <tr> <td>pattern</td> <td>[1-9]{1}[0-9]*</td> </tr> </tbody> </table>	Kind	Value	pattern	[1-9]{1}[0-9]*
Kind	Value				
pattern	[1-9]{1}[0-9]*				
source	<code><xs:element name="CredAltriSisma" type="cm:DatoNP_Type" minOccurs="0"/></code>				

element **Imposta_Netta_Type/CredAbitazSisma**

diagram					
namespace	urn:www.agenziaentrate.gov.it:specificheTecniche:sco:730				
type	DatoNP_Type				
facets	<table border="1"> <thead> <tr> <th>Kind</th> <th>Value</th> </tr> </thead> <tbody> <tr> <td>pattern</td> <td>[1-9]{1}[0-9]*</td> </tr> </tbody> </table>	Kind	Value	pattern	[1-9]{1}[0-9]*
Kind	Value				
pattern	[1-9]{1}[0-9]*				
source	<code><xs:element name="CredAbitazSisma" type="cm:DatoNP_Type" minOccurs="0"/></code>				

element **Imposta_Netta_Type/CredImpEstere**

diagram	
namespace	urn:www.agenziaentrate.gov.it:specificheTecniche:sco:730

type	DatoNP_Type
facets	Kind Value pattern [1-9]{1}[0-9]*
source	<xs:element name="CredImpEstere" type="cm:DatoNP_Type" minOccurs="0"/>

element **Imposta_Netta_Type/CredErogCultura**

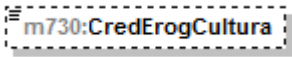
diagram	
namespace	urn:www.agenziaentrate.gov.it:specificheTecniche:sco:730
type	DatoNP_Type
facets	Kind Value pattern [1-9]{1}[0-9]*
source	<xs:element name="CredErogCultura" type="cm:DatoNP_Type" minOccurs="0"/>

element **Imposta_Netta_Type/CredCanNonPerc**

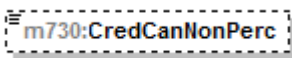
diagram	
namespace	urn:www.agenziaentrate.gov.it:specificheTecniche:sco:730
type	DatoNP_Type
facets	Kind Value pattern [1-9]{1}[0-9]*
source	<xs:element name="CredCanNonPerc" type="cm:DatoNP_Type" minOccurs="0"/>

element **Imposta_Netta_Type/CredDetrazIncapienti**

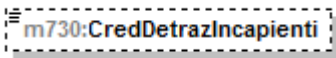
diagram	
namespace	urn:www.agenziaentrate.gov.it:specificheTecniche:sco:730
type	DatoNP_Type
facets	Kind Value pattern [1-9]{1}[0-9]*
source	<xs:element name="CredDetrazIncapienti" type="cm:DatoNP_Type" minOccurs="0"/>

element **Imposta_Netta_Type/Ritenute**

diagram	
namespace	urn:www.agenziaentrate.gov.it:specificheTecniche:sco:730
type	DatoNP_Type
facets	Kind Value pattern [1-9]{1}[0-9]*
source	<xs:element name="Ritenute" type="cm:DatoNP_Type" minOccurs="0"/>

element **Imposta_Netta_Type/Differenza**

diagram	
---------	---

namespace	urn:www.agenziaentrate.gov.it:specificheTecniche:sco:730
type	DatoNU_Type
facets	Kind Value pattern (\-[1-9] [1-9])[0-9]*
source	<xs:element name="Differenza" type="cm:DatoNU_Type" minOccurs="0"/>

element **Imposta_Netta_Type/EccedenzaIrpef**

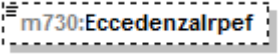
diagram	
namespace	urn:www.agenziaentrate.gov.it:specificheTecniche:sco:730
type	DatoNU_Type
facets	Kind Value pattern (\-[1-9] [1-9])[0-9]*
source	<xs:element name="EccedenzaIrpef" type="cm:DatoNU_Type" minOccurs="0"/>

element **Imposta_Netta_Type/AccountiVersati**

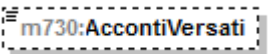
diagram	
namespace	urn:www.agenziaentrate.gov.it:specificheTecniche:sco:730
type	DatoNP_Type
facets	Kind Value pattern [1-9]{1}[0-9]*
source	<xs:element name="AccountiVersati" type="cm:DatoNP_Type" minOccurs="0"/>

element **Imposta_Netta_Type/RestituzioneBonus**

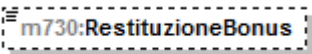
diagram	
namespace	urn:www.agenziaentrate.gov.it:specificheTecniche:sco:730
type	DatoNP_Type
facets	Kind Value pattern [1-9]{1}[0-9]*
source	<xs:element name="RestituzioneBonus" type="cm:DatoNP_Type" minOccurs="0"/>

element **Imposta_Netta_Type/CredRimborsatiSost**

diagram	
namespace	urn:www.agenziaentrate.gov.it:specificheTecniche:sco:730
type	DatoNP_Type
facets	Kind Value pattern [1-9]{1}[0-9]*
source	<xs:element name="CredRimborsatiSost" type="cm:DatoNP_Type" minOccurs="0"/>

element **Imposta_Netta_Type/BonusIrpefSpettante**

diagram	
namespace	urn:www.agenziaentrate.gov.it:specificheTecniche:sco:730
type	DatoNP_Type
facets	Kind Value pattern [1-9]{1}[0-9]*
source	<code><xs:element name="BonusIrpefSpettante" type="cm:DatoNP_Type" minOccurs="0"/></code>

element **Imposta_Netta_Type/BonusIrpefRiconosciuto**

diagram	
namespace	urn:www.agenziaentrate.gov.it:specificheTecniche:sco:730
type	DatoNP_Type
facets	Kind Value pattern [1-9]{1}[0-9]*
source	<code><xs:element name="BonusIrpefRiconosciuto" type="cm:DatoNP_Type" minOccurs="0"/></code>

element **Imposta_Netta_Type/RestituzioneBonusIrpef**

diagram	
namespace	urn:www.agenziaentrate.gov.it:specificheTecniche:sco:730
type	DatoNP_Type
facets	Kind Value pattern [1-9]{1}[0-9]*
source	<code><xs:element name="RestituzioneBonusIrpef" type="cm:DatoNP_Type" minOccurs="0"/></code>

complexType **Imposte_Rimborsate_Type**

diagram	
namespace	urn:www.agenziaentrate.gov.it:specificheTecniche:sco:730
children	m730:TipoReddito m730:TassazioneSeparata
source	<code><xs:complexType name="Imposte_Rimborsate_Type"> <xs:sequence> <xs:element name="TipoReddito" type="m730:Tipo_Reddito_Da1a8_Type"/> <xs:element name="TassazioneSeparata" type="m730:Tassazione_Separata_Type" minOccurs="0"/> </xs:sequence> </xs:complexType></code>

element **Imposte_Rimborsate_Type/TipoReddito**

diagram	
namespace	urn:www.agenziaentrate.gov.it:specificheTecniche:sco:730

type	m730:Tipo_Reddito_Da1a8_Type	
facets	Kind	Value
	pattern	[1-9]{1}[0-9]*
	enumeration	1
	enumeration	2
	enumeration	3
	enumeration	4
	enumeration	5
	enumeration	6
	enumeration	7
	enumeration	8
source	<xs:element name="TipoReddito" type="m730:Tipo_Reddito_Da1a8_Type"/>	

element **Imposte_Rimborsate_Type/TassazioneSeparata**

diagram		
namespace	urn:www.agenziaentrate.gov.it:specificheTecniche:sco:730	
type	m730:Tassazione_Separata_Type	
children	m730:Opzione m730:Anno m730:RedditoRitenute	
source	<xs:element name="TassazioneSeparata" type="m730:Tassazione_Separata_Type" minOccurs="0"/>	

complexType **Incremento_Produttivita_Type**

diagram		
namespace	urn:www.agenziaentrate.gov.it:specificheTecniche:sco:730	
children	m730:ImportoTassazOrdinaria m730:ImportoImpostaSostitutiva m730:RitenuteImpostaSostitutiva m730:Art51Ordinaria m730:Art51Sostitutiva m730:TassazOrdinaria m730:TassazSostitutiva	
source	<pre><xs:complexType name="Incremento_Produttivita_Type"> <xs:sequence> <xs:element name="ImportoTassazOrdinaria" type="cm:DatoNP_Type" minOccurs="0"/> <xs:element name="ImportoImpostaSostitutiva" type="cm:DatoNP_Type" minOccurs="0"/> <xs:element name="RitenuteImpostaSostitutiva" type="cm:DatoNP_Type" minOccurs="0"/> </xs:sequence> </xs:complexType></pre>	

	<pre> <xs:element name="Art51Ordinaria" type="cm:DatoNP_Type" minOccurs="0"/> <xs:element name="Art51Sostitutiva" type="cm:DatoNP_Type" minOccurs="0"/> <xs:choice minOccurs="0"> <xs:element name="TassazOrdinaria" type="cm:DatoCB_Type"/> <xs:element name="TassazSostitutiva" type="cm:DatoCB_Type"/> </xs:choice> </xs:sequence> </xs:complexType> </pre>
--	--

element **Incremento_Produttivita_Type/ImportoTassazOrdinaria**

diagram					
namespace	urn:www.agenziaentrate.gov.it:specificheTecniche:sco:730				
type	DatoNP_Type				
facets	<table border="1"> <tr> <td>Kind</td> <td>Value</td> </tr> <tr> <td>pattern</td> <td>[1-9]{1}[0-9]*</td> </tr> </table>	Kind	Value	pattern	[1-9]{1}[0-9]*
Kind	Value				
pattern	[1-9]{1}[0-9]*				
source	<pre><xs:element name="ImportoTassazOrdinaria" type="cm:DatoNP_Type" minOccurs="0"/></pre>				

element **Incremento_Produttivita_Type/ImportoImpostaSostitutiva**

diagram					
namespace	urn:www.agenziaentrate.gov.it:specificheTecniche:sco:730				
type	DatoNP_Type				
facets	<table border="1"> <tr> <td>Kind</td> <td>Value</td> </tr> <tr> <td>pattern</td> <td>[1-9]{1}[0-9]*</td> </tr> </table>	Kind	Value	pattern	[1-9]{1}[0-9]*
Kind	Value				
pattern	[1-9]{1}[0-9]*				
source	<pre><xs:element name="ImportoImpostaSostitutiva" type="cm:DatoNP_Type" minOccurs="0"/></pre>				

element **Incremento_Produttivita_Type/RitenuteImpostaSostitutiva**

diagram					
namespace	urn:www.agenziaentrate.gov.it:specificheTecniche:sco:730				
type	DatoNP_Type				
facets	<table border="1"> <tr> <td>Kind</td> <td>Value</td> </tr> <tr> <td>pattern</td> <td>[1-9]{1}[0-9]*</td> </tr> </table>	Kind	Value	pattern	[1-9]{1}[0-9]*
Kind	Value				
pattern	[1-9]{1}[0-9]*				
source	<pre><xs:element name="RitenuteImpostaSostitutiva" type="cm:DatoNP_Type" minOccurs="0"/></pre>				

element **Incremento_Produttivita_Type/Art51Ordinaria**

diagram					
namespace	urn:www.agenziaentrate.gov.it:specificheTecniche:sco:730				
type	DatoNP_Type				
facets	<table border="1"> <tr> <td>Kind</td> <td>Value</td> </tr> <tr> <td>pattern</td> <td>[1-9]{1}[0-9]*</td> </tr> </table>	Kind	Value	pattern	[1-9]{1}[0-9]*
Kind	Value				
pattern	[1-9]{1}[0-9]*				
source	<pre><xs:element name="Art51Ordinaria" type="cm:DatoNP_Type" minOccurs="0"/></pre>				

element **Incremento_Produttivita_Type/Art51Sostitutiva**

diagram	
namespace	urn:www.agenziaentrate.gov.it:specificheTecniche:sco:730
type	DatoNP_Type
facets	Kind Value pattern [1-9]{1}[0-9]*
source	<code><xs:element name="Art51Sostitutiva" type="cm:DatoNP_Type" minOccurs="0"/></code>

element **Incremento_Produttivita_Type/TassazOrdinaria**

diagram	
namespace	urn:www.agenziaentrate.gov.it:specificheTecniche:sco:730
type	DatoCB_Type
facets	Kind Value pattern [01]
source	<code><xs:element name="TassazOrdinaria" type="cm:DatoCB_Type"/></code>

element **Incremento_Produttivita_Type/TassazSostitutiva**

diagram	
namespace	urn:www.agenziaentrate.gov.it:specificheTecniche:sco:730
type	DatoCB_Type
facets	Kind Value pattern [01]
source	<code><xs:element name="TassazSostitutiva" type="cm:DatoCB_Type"/></code>

complexType **Inquilini_Abitazione_Principale_Type**

diagram	
namespace	urn:www.agenziaentrate.gov.it:specificheTecniche:sco:730
children	m730:Tipologia m730:GiorniPercentuale
source	<code><xs:complexType name="Inquilini_Abitazione_Principale_Type"> <xs:sequence> <xs:element name="Tipologia" type="m730:Tipo_Inquilino_Type"/> <xs:element name="GiorniPercentuale" type="m730:Giorni_Percentuale_Type"/> </xs:sequence> </xs:complexType></code>

element **Inquilini_Abitazione_Principale_Type/Tipologia**

diagram	
namespace	urn:www.agenziaentrate.gov.it:specificheTecniche:sco:730

type	m730:Tipo_Inquilino_Type	
facets	Kind	Value
	pattern	[1-9]{1}[0-9]*
	enumeration	1
	enumeration	2
	enumeration	3
	enumeration	4
source	<xs:element name="Tipologia" type="m730:Tipo_Inquilino_Type"/>	

element **Inquilini_Abitazione_Principale_Type/GiorniPercentuale**

diagram		
namespace	urn:www.agenziaentrate.gov.it:specificheTecniche:sco:730	
type	m730:Giorni_Percentuale_Type	
children	m730:Giorni m730:Percentuale	
source	<xs:element name="GiorniPercentuale" type="m730:Giorni_Percentuale_Type"/>	

complexType **Intervento_Recupero_Patrimonio_Edilizio_Type**

diagram		
namespace	urn:www.agenziaentrate.gov.it:specificheTecniche:sco:730	
children	m730:Anno m730:Periodo m730:CodiceFiscale m730:CasellaInterventiParticolari m730:CodiceSituazioniParticolari m730:AnnoSituazioniParticolari m730:RideterminazioneRate m730:NRate m730:Spesa m730:NOrdineImmobile	
source	<pre><xs:complexType name="Intervento_Recupero_Patrimonio_Edilizio_Type"> <xs:sequence> <!--<xs:element name="Anno" type="cm:DatoDA_Type" minOccurs="0"/>--></pre>	

	<pre> <xs:element name="Anno"> <xs:simpleType> <xs:restriction base="m730:Anno_Recupero_Patrimonio_Edilizio_Type"/> </xs:simpleType> </xs:element> <xs:element name="Periodo" type="m730:Periodo_Spese_Ristrutturazione_Type" minOccurs="0"/> <xs:element name="CodiceFiscale" type="cm:DatoCF_Type" minOccurs="0"/> <xs:element name="CasellaInterventiParticolari" minOccurs="0"> <xs:simpleType> <xs:restriction base="cm:DatoN1_Type"> <xs:enumeration value="1"/> <xs:enumeration value="3"/> <xs:enumeration value="4"/> </xs:restriction> </xs:simpleType> </xs:element> <xs:element name="CodiceSituazioniParticolari" type="m730:Casella_Codice_Type" minOccurs="0"/> <xs:element name="AnnoSituazioniParticolari" type="m730:Anno_Patrimonio_Edilizio_Situazioni_Particolari_Type" minOccurs="0"/> <xs:element name="RideterminazioneRate" type="m730:Rideterminazione_Rate_Type" minOccurs="0"/> <xs:element name="NRate" type="m730:N_Rate_Type"/> <xs:element name="Spesa" type="cm:DatoNP_Type"/> <xs:element name="NOrdinImmobile" type="cm:DatoNP_Type" minOccurs="0"/> </xs:sequence> </xs:complexType> </pre>
--	---

element **Intervento_Recupero_Patrimonio_Edilizio_Type/Anno**

diagram																									
namespace	urn:www.agenziaentrate.gov.it:specificheTecniche:sco:730																								
type	restriction of m730:Anno_Recupero_Patrimonio_Edilizio_Type																								
facets	<table border="1"> <thead> <tr> <th>Kind</th> <th>Value</th> </tr> </thead> <tbody> <tr> <td>pattern</td> <td>[1-9]{1}[0-9]*</td> </tr> <tr> <td>enumeration</td> <td>2005</td> </tr> <tr> <td>enumeration</td> <td>2006</td> </tr> <tr> <td>enumeration</td> <td>2007</td> </tr> <tr> <td>enumeration</td> <td>2008</td> </tr> <tr> <td>enumeration</td> <td>2009</td> </tr> <tr> <td>enumeration</td> <td>2010</td> </tr> <tr> <td>enumeration</td> <td>2011</td> </tr> <tr> <td>enumeration</td> <td>2012</td> </tr> <tr> <td>enumeration</td> <td>2013</td> </tr> <tr> <td>enumeration</td> <td>2014</td> </tr> </tbody> </table>	Kind	Value	pattern	[1-9]{1}[0-9]*	enumeration	2005	enumeration	2006	enumeration	2007	enumeration	2008	enumeration	2009	enumeration	2010	enumeration	2011	enumeration	2012	enumeration	2013	enumeration	2014
Kind	Value																								
pattern	[1-9]{1}[0-9]*																								
enumeration	2005																								
enumeration	2006																								
enumeration	2007																								
enumeration	2008																								
enumeration	2009																								
enumeration	2010																								
enumeration	2011																								
enumeration	2012																								
enumeration	2013																								
enumeration	2014																								
source	<pre> <xs:element name="Anno"> <xs:simpleType> <xs:restriction base="m730:Anno_Recupero_Patrimonio_Edilizio_Type"/> </xs:simpleType> </xs:element> </pre>																								

element **Intervento_Recupero_Patrimonio_Edilizio_Type/Periodo**

diagram											
namespace	urn:www.agenziaentrate.gov.it:specificheTecniche:sco:730										
type	m730:Periodo_Spese_Ristrutturazione_Type										
facets	<table border="1"> <thead> <tr> <th>Kind</th> <th>Value</th> </tr> </thead> <tbody> <tr> <td>pattern</td> <td>[1-9]</td> </tr> <tr> <td>enumeration</td> <td>1</td> </tr> <tr> <td>enumeration</td> <td>2</td> </tr> <tr> <td>enumeration</td> <td>3</td> </tr> </tbody> </table>	Kind	Value	pattern	[1-9]	enumeration	1	enumeration	2	enumeration	3
Kind	Value										
pattern	[1-9]										
enumeration	1										
enumeration	2										
enumeration	3										

	enumeration 4
source	<xs:element name="Periodo" type="m730:Periodo_Spese_Ristrutturazione_Type" minOccurs="0"/>

element **Intervento_Ricupero_Patrimonio_Edilizio_Type/CodiceFiscale**

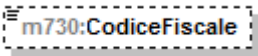
diagram					
namespace	urn:www.agenziaentrate.gov.it:specificheTecniche:sco:730				
type	DatoCF_Type				
facets	<table border="1"> <thead> <tr> <th>Kind</th> <th>Value</th> </tr> </thead> <tbody> <tr> <td>pattern</td> <td>[0-9]{11}[A-Z]{6}[0-9LMNPQRSTUVWXYZ]{2}[A-Z]{1}[0-9LMNPQRSTUVWXYZ]{2}[A-Z]{1}[0-9LMNPQRSTUVWXYZ]{3}[A-Z]{1}</td> </tr> </tbody> </table>	Kind	Value	pattern	[0-9]{11}[A-Z]{6}[0-9LMNPQRSTUVWXYZ]{2}[A-Z]{1}[0-9LMNPQRSTUVWXYZ]{2}[A-Z]{1}[0-9LMNPQRSTUVWXYZ]{3}[A-Z]{1}
Kind	Value				
pattern	[0-9]{11}[A-Z]{6}[0-9LMNPQRSTUVWXYZ]{2}[A-Z]{1}[0-9LMNPQRSTUVWXYZ]{2}[A-Z]{1}[0-9LMNPQRSTUVWXYZ]{3}[A-Z]{1}				
source	<xs:element name="CodiceFiscale" type="cm:DatoCF_Type" minOccurs="0"/>				

element **Intervento_Ricupero_Patrimonio_Edilizio_Type/CasellaInterventiParticolari**

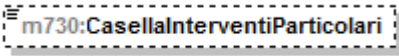
diagram											
namespace	urn:www.agenziaentrate.gov.it:specificheTecniche:sco:730										
type	restriction of DatoN1_Type										
facets	<table border="1"> <thead> <tr> <th>Kind</th> <th>Value</th> </tr> </thead> <tbody> <tr> <td>pattern</td> <td>[1-9]</td> </tr> <tr> <td>enumeration</td> <td>1</td> </tr> <tr> <td>enumeration</td> <td>3</td> </tr> <tr> <td>enumeration</td> <td>4</td> </tr> </tbody> </table>	Kind	Value	pattern	[1-9]	enumeration	1	enumeration	3	enumeration	4
Kind	Value										
pattern	[1-9]										
enumeration	1										
enumeration	3										
enumeration	4										
source	<pre><xs:element name="CasellaInterventiParticolari" minOccurs="0"> <xs:simpleType> <xs:restriction base="cm:DatoN1_Type"> <xs:enumeration value="1"/> <xs:enumeration value="3"/> <xs:enumeration value="4"/> </xs:restriction> </xs:simpleType> </xs:element></pre>										

element **Intervento_Ricupero_Patrimonio_Edilizio_Type/CodiceSituazioniParticolari**

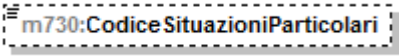
diagram									
namespace	urn:www.agenziaentrate.gov.it:specificheTecniche:sco:730								
type	m730:Casella_Codice_Type								
facets	<table border="1"> <thead> <tr> <th>Kind</th> <th>Value</th> </tr> </thead> <tbody> <tr> <td>pattern</td> <td>[1-9]</td> </tr> <tr> <td>enumeration</td> <td>1</td> </tr> <tr> <td>enumeration</td> <td>4</td> </tr> </tbody> </table>	Kind	Value	pattern	[1-9]	enumeration	1	enumeration	4
Kind	Value								
pattern	[1-9]								
enumeration	1								
enumeration	4								
source	<xs:element name="CodiceSituazioniParticolari" type="m730:Casella_Codice_Type" minOccurs="0"/>								

element **Intervento_Ricupero_Patrimonio_Edilizio_Type/AnnoSituazioniParticolari**

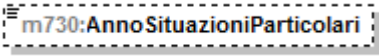
diagram	
namespace	urn:www.agenziaentrate.gov.it:specificheTecniche:sco:730
type	m730:Anno Patrimonio Edilizio Situazioni Particolari_Type

facets	Kind	Value
	pattern	[1-9]{1}[0-9]*
	enumeration	2010
	enumeration	2011
source	<xs:element name="AnnoSituazioniParticolari" type="m730:Anno_Patrimonio_Edilizio_Situazioni_Particolari_Type" minOccurs="0"/>	

element **Intervento_Ricupero_Patrimonio_Edilizio_Type/RideterminazioneRate**

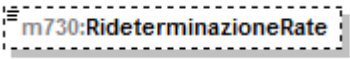
diagram		
namespace	urn:www.agenziaentrate.gov.it:specificheTecniche:sco:730	
type	m730:Rideterminazione_Rate_Type	
facets	Kind	Value
	pattern	[1-9]{1}[0-9]*
	enumeration	10
source	<xs:element name="RideterminazioneRate" type="m730:Rideterminazione_Rate_Type" minOccurs="0"/>	

element **Intervento_Ricupero_Patrimonio_Edilizio_Type/NRate**

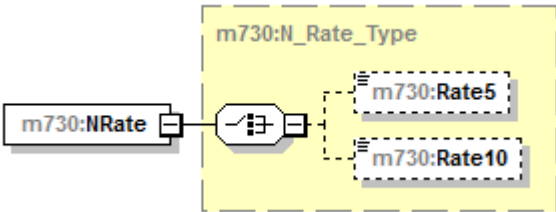
diagram		
namespace	urn:www.agenziaentrate.gov.it:specificheTecniche:sco:730	
type	m730:N_Rate_Type	
children	m730:Rate5 m730:Rate10	
source	<xs:element name="NRate" type="m730:N_Rate_Type"/>	

element **Intervento_Ricupero_Patrimonio_Edilizio_Type/Spesa**

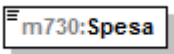
diagram		
namespace	urn:www.agenziaentrate.gov.it:specificheTecniche:sco:730	
type	DatoNP_Type	
facets	Kind	Value
	pattern	[1-9]{1}[0-9]*
source	<xs:element name="Spesa" type="cm:DatoNP_Type"/>	

element **Intervento_Ricupero_Patrimonio_Edilizio_Type/NOrdineImmobile**

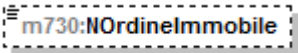
diagram		
namespace	urn:www.agenziaentrate.gov.it:specificheTecniche:sco:730	
type	DatoNP_Type	
facets	Kind	Value
	pattern	[1-9]{1}[0-9]*

source	<xs:element name="NOrdinelImmobile" type="cm:DatoNP_Type" minOccurs="0"/>
--------	---

complexType **Intervento_Risparmio_Energetico_Type**

diagram	
namespace	urn:www.agenziaentrate.gov.it:specificheTecniche:sco:730
children	m730:Tipointervento m730:Anno m730:Periodo2013 m730:CasiParticolari m730:RideterminazioneRate m730:RipartizioneRate m730:NumeroRata m730:Spesa
source	<pre> <xs:complexType name="Intervento_Risparmio_Energetico_Type"> <xs:sequence> <xs:element name="Tipointervento" type="m730:Tipo_Intervento_Type"/> <xs:element name="Anno"> <xs:simpleType> <xs:restriction base="m730:Anno_Risparmio_Energetico_Type"/> </xs:simpleType> </xs:element> <xs:element name="Periodo2013" minOccurs="0"> <xs:simpleType> <xs:restriction base="cm:DatoN1_Type"> <xs:enumeration value="1"/> <xs:enumeration value="2"/> </xs:restriction> </xs:simpleType> </xs:element> <xs:element name="CasiParticolari" type="m730:Casi_Particolari_Risp_Ener_Type" minOccurs="0"/> <xs:element name="RideterminazioneRate" type="m730:Rate_Risparmio_Energetico_Type" minOccurs="0"/> <xs:element name="RipartizioneRate" type="m730:Ripart_Risparmio_Energetico_Type"/> <xs:element name="NumeroRata" type="m730:Numero_Rata_Risparmi_Energetico_Type"/> <xs:element name="Spesa" type="cm:DatoNP_Type"/> </xs:sequence> </xs:complexType> </pre>

element **Intervento_Risparmio_Energetico_Type/Tipointervento**

diagram							
namespace	urn:www.agenziaentrate.gov.it:specificheTecniche:sco:730						
type	m730:Tipo_Intervento_Type						
facets	<table border="1"> <thead> <tr> <th>Kind</th> <th>Value</th> </tr> </thead> <tbody> <tr> <td>pattern</td> <td>[1-9]</td> </tr> <tr> <td>enumeration</td> <td>1</td> </tr> </tbody> </table>	Kind	Value	pattern	[1-9]	enumeration	1
Kind	Value						
pattern	[1-9]						
enumeration	1						

	enumeration 2 enumeration 3 enumeration 4
source	<xs:element name="TipoIntervento" type="m730:Tipo_Intervento_Type"/>

element **Intervento_Risparmio_Energetico_Type/Anno**

diagram																	
namespace	urn:www.agenziaentrate.gov.it:specificheTecniche:sco:730																
type	restriction of m730:Anno_Risparmio_Energetico_Type																
facets	<table border="1"> <thead> <tr> <th>Kind</th> <th>Value</th> </tr> </thead> <tbody> <tr> <td>pattern</td> <td>[1-9]{1}[0-9]*</td> </tr> <tr> <td>enumeration</td> <td>2008</td> </tr> <tr> <td>enumeration</td> <td>2010</td> </tr> <tr> <td>enumeration</td> <td>2011</td> </tr> <tr> <td>enumeration</td> <td>2012</td> </tr> <tr> <td>enumeration</td> <td>2013</td> </tr> <tr> <td>enumeration</td> <td>2014</td> </tr> </tbody> </table>	Kind	Value	pattern	[1-9]{1}[0-9]*	enumeration	2008	enumeration	2010	enumeration	2011	enumeration	2012	enumeration	2013	enumeration	2014
Kind	Value																
pattern	[1-9]{1}[0-9]*																
enumeration	2008																
enumeration	2010																
enumeration	2011																
enumeration	2012																
enumeration	2013																
enumeration	2014																
source	<pre><xs:element name="Anno"> <xs:simpleType> <xs:restriction base="m730:Anno_Risparmio_Energetico_Type"/> </xs:simpleType> </xs:element></pre>																

element **Intervento_Risparmio_Energetico_Type/Periodo2013**

diagram									
namespace	urn:www.agenziaentrate.gov.it:specificheTecniche:sco:730								
type	restriction of DatoN1_Type								
facets	<table border="1"> <thead> <tr> <th>Kind</th> <th>Value</th> </tr> </thead> <tbody> <tr> <td>pattern</td> <td>[1-9]</td> </tr> <tr> <td>enumeration</td> <td>1</td> </tr> <tr> <td>enumeration</td> <td>2</td> </tr> </tbody> </table>	Kind	Value	pattern	[1-9]	enumeration	1	enumeration	2
Kind	Value								
pattern	[1-9]								
enumeration	1								
enumeration	2								
source	<pre><xs:element name="Periodo2013" minOccurs="0"> <xs:simpleType> <xs:restriction base="cm:DatoN1_Type"> <xs:enumeration value="1"/> <xs:enumeration value="2"/> </xs:restriction> </xs:simpleType> </xs:element></pre>								

element **Intervento_Risparmio_Energetico_Type/CasiParticolari**

diagram											
namespace	urn:www.agenziaentrate.gov.it:specificheTecniche:sco:730										
type	m730:Casi_Particolari_Risp_Ener_Type										
facets	<table border="1"> <thead> <tr> <th>Kind</th> <th>Value</th> </tr> </thead> <tbody> <tr> <td>pattern</td> <td>[1-9]</td> </tr> <tr> <td>enumeration</td> <td>1</td> </tr> <tr> <td>enumeration</td> <td>2</td> </tr> <tr> <td>enumeration</td> <td>3</td> </tr> </tbody> </table>	Kind	Value	pattern	[1-9]	enumeration	1	enumeration	2	enumeration	3
Kind	Value										
pattern	[1-9]										
enumeration	1										
enumeration	2										
enumeration	3										
source	<xs:element name="CasiParticolari" type="m730:Casi_Particolari_Risp_Ener_Type" minOccurs="0"/>										

element **Intervento_Risparmio_Energetico_Type/RideterminazioneRate**

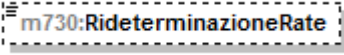
diagram																					
namespace	urn:www.agenziaentrate.gov.it:specificheTecniche:sco:730																				
type	m730:Rate Risparmio Energetico Type																				
facets	<table border="1"> <thead> <tr> <th>Kind</th> <th>Value</th> </tr> </thead> <tbody> <tr> <td>pattern</td> <td>[1-9]{1}[0-9]*</td> </tr> <tr> <td>enumeration</td> <td>3</td> </tr> <tr> <td>enumeration</td> <td>4</td> </tr> <tr> <td>enumeration</td> <td>5</td> </tr> <tr> <td>enumeration</td> <td>6</td> </tr> <tr> <td>enumeration</td> <td>7</td> </tr> <tr> <td>enumeration</td> <td>8</td> </tr> <tr> <td>enumeration</td> <td>9</td> </tr> <tr> <td>enumeration</td> <td>10</td> </tr> </tbody> </table>	Kind	Value	pattern	[1-9]{1}[0-9]*	enumeration	3	enumeration	4	enumeration	5	enumeration	6	enumeration	7	enumeration	8	enumeration	9	enumeration	10
Kind	Value																				
pattern	[1-9]{1}[0-9]*																				
enumeration	3																				
enumeration	4																				
enumeration	5																				
enumeration	6																				
enumeration	7																				
enumeration	8																				
enumeration	9																				
enumeration	10																				
source	<code><xs:element name="RideterminazioneRate" type="m730:Rate_Risparmio_Energetico_Type" minOccurs="0"/></code>																				

element **Intervento_Risparmio_Energetico_Type/RipartizioneRate**

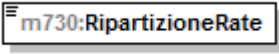
diagram																			
namespace	urn:www.agenziaentrate.gov.it:specificheTecniche:sco:730																		
type	m730:Ripart Risparmio Energetico Type																		
facets	<table border="1"> <thead> <tr> <th>Kind</th> <th>Value</th> </tr> </thead> <tbody> <tr> <td>pattern</td> <td>[1-9]{1}[0-9]*</td> </tr> <tr> <td>enumeration</td> <td>4</td> </tr> <tr> <td>enumeration</td> <td>5</td> </tr> <tr> <td>enumeration</td> <td>6</td> </tr> <tr> <td>enumeration</td> <td>7</td> </tr> <tr> <td>enumeration</td> <td>8</td> </tr> <tr> <td>enumeration</td> <td>9</td> </tr> <tr> <td>enumeration</td> <td>10</td> </tr> </tbody> </table>	Kind	Value	pattern	[1-9]{1}[0-9]*	enumeration	4	enumeration	5	enumeration	6	enumeration	7	enumeration	8	enumeration	9	enumeration	10
Kind	Value																		
pattern	[1-9]{1}[0-9]*																		
enumeration	4																		
enumeration	5																		
enumeration	6																		
enumeration	7																		
enumeration	8																		
enumeration	9																		
enumeration	10																		
source	<code><xs:element name="RipartizioneRate" type="m730:Ripart_Risparmio_Energetico_Type"/></code>																		

element **Intervento_Risparmio_Energetico_Type/NumeroRata**

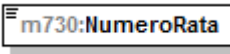
diagram																			
namespace	urn:www.agenziaentrate.gov.it:specificheTecniche:sco:730																		
type	m730:Numero Rata Risparmi Energetico Type																		
facets	<table border="1"> <thead> <tr> <th>Kind</th> <th>Value</th> </tr> </thead> <tbody> <tr> <td>pattern</td> <td>[1-9]{1}[0-9]*</td> </tr> <tr> <td>enumeration</td> <td>1</td> </tr> <tr> <td>enumeration</td> <td>2</td> </tr> <tr> <td>enumeration</td> <td>3</td> </tr> <tr> <td>enumeration</td> <td>4</td> </tr> <tr> <td>enumeration</td> <td>5</td> </tr> <tr> <td>enumeration</td> <td>6</td> </tr> <tr> <td>enumeration</td> <td>7</td> </tr> </tbody> </table>	Kind	Value	pattern	[1-9]{1}[0-9]*	enumeration	1	enumeration	2	enumeration	3	enumeration	4	enumeration	5	enumeration	6	enumeration	7
Kind	Value																		
pattern	[1-9]{1}[0-9]*																		
enumeration	1																		
enumeration	2																		
enumeration	3																		
enumeration	4																		
enumeration	5																		
enumeration	6																		
enumeration	7																		
source	<code><xs:element name="NumeroRata" type="m730:Numero_Rata_Risparmi_Energetico_Type"/></code>																		

element **Intervento_Risparmio_Energetico_Type/Spesa**

diagram	
namespace	urn:www.agenziaentrate.gov.it:specificheTecniche:sco:730
type	DatoNP_Type
facets	Kind Value pattern [1-9]{1}[0-9]*
source	<code><xs:element name="Spesa" type="cm:DatoNP_Type"/></code>

complexType **Lavoro_Dipendente_Type**

diagram	
namespace	urn:www.agenziaentrate.gov.it:specificheTecniche:sco:730
children	m730:TipologiaReddito m730:TipoContratto m730:Reddito
source	<code><xs:complexType name="Lavoro_Dipendente_Type"> <xs:sequence> <xs:element name="TipologiaReddito" type="m730:Tipo_Reddito_Da1a4_Type"/> <xs:element name="TipoContratto" type="m730:Indeterminato_Determinato_Type" minOccurs="0"/> <xs:element name="Reddito" type="cm:DatoNP_Type"/> </xs:sequence> </xs:complexType></code>

element **Lavoro_Dipendente_Type/TipologiaReddito**

diagram	
namespace	urn:www.agenziaentrate.gov.it:specificheTecniche:sco:730
type	m730:Tipo_Reddito_Da1a4_Type
facets	Kind Value pattern [1-9] enumeration 1 enumeration 2 enumeration 3 enumeration 4
source	<code><xs:element name="TipologiaReddito" type="m730:Tipo_Reddito_Da1a4_Type"/></code>

element **Lavoro_Dipendente_Type/TipoContratto**

diagram	
namespace	urn:www.agenziaentrate.gov.it:specificheTecniche:sco:730
type	m730:Indeterminato_Determinato_Type
facets	Kind Value pattern [1-9] enumeration 1 enumeration 2

source	<xs:element name="TipoContratto" type="m730:Indeterminato_Determinato_Type" minOccurs="0"/>
--------	---

element **Lavoro_Dipendente_Type/Reddito**

diagram					
namespace	urn:www.agenziaentrate.gov.it:specificheTecniche:sco:730				
type	DatoNP_Type				
facets	<table border="1"> <tr> <th>Kind</th> <th>Value</th> </tr> <tr> <td>pattern</td> <td>[1-9]{1}[0-9]*</td> </tr> </table>	Kind	Value	pattern	[1-9]{1}[0-9]*
Kind	Value				
pattern	[1-9]{1}[0-9]*				
source	<xs:element name="Reddito" type="cm:DatoNP_Type"/>				

complexType **Misura_Acconti_Type**

diagram	
namespace	urn:www.agenziaentrate.gov.it:specificheTecniche:sco:730
children	m730:IrpefMisuralInferiore m730:AddComunaleMisuralInferiore m730:CedolareSeccaMisuralInferiore m730:NumeroRate
source	<pre> <xs:complexType name="Misura_Acconti_Type"> <xs:sequence> <xs:element name="IrpefMisuralInferiore" type="m730:Casella_Acconto_Type" minOccurs="0"/> <xs:element name="AddComunaleMisuralInferiore" type="m730:Casella_Acconto_Type" minOccurs="0"/> <xs:element name="CedolareSeccaMisuralInferiore" type="m730:Casella_Acconto_Type" minOccurs="0"/> <xs:element name="NumeroRate" minOccurs="0"/> </xs:sequence> <xs:simpleType> <xs:restriction base="cm:DatoN1_Type"> <xs:enumeration value="2"/> <xs:enumeration value="3"/> <xs:enumeration value="4"/> <xs:enumeration value="5"/> <xs:enumeration value="6"/> <xs:enumeration value="7"/> </xs:restriction> </xs:simpleType> </xs:complexType> </pre>

element **Misura_Acconti_Type/IrpefMisuralInferiore**

diagram	
---------	--

namespace	urn:www.agenziaentrate.gov.it:specificheTecniche:sco:730
type	m730:Casella_Aconto_Type
children	m730:Casella m730:ImportoMisuralInferiore
source	<xs:element name="IrpefMisuralInferiore" type="m730:Casella_Aconto_Type" minOccurs="0"/>

element **Misura_Aconti_Type/AddComunaleMisuralInferiore**

diagram	
namespace	urn:www.agenziaentrate.gov.it:specificheTecniche:sco:730
type	m730:Casella_Aconto_Type
children	m730:Casella m730:ImportoMisuralInferiore
source	<xs:element name="AddComunaleMisuralInferiore" type="m730:Casella_Aconto_Type" minOccurs="0"/>

element **Misura_Aconti_Type/CedolareSeccaMisuralInferiore**

diagram	
namespace	urn:www.agenziaentrate.gov.it:specificheTecniche:sco:730
type	m730:Casella_Aconto_Type
children	m730:Casella m730:ImportoMisuralInferiore
source	<xs:element name="CedolareSeccaMisuralInferiore" type="m730:Casella_Aconto_Type" minOccurs="0"/>

element **Misura_Aconti_Type/NumeroRate**

diagram																	
namespace	urn:www.agenziaentrate.gov.it:specificheTecniche:sco:730																
type	restriction of DatoN1_Type																
facets	<table border="1"> <thead> <tr> <th>Kind</th> <th>Value</th> </tr> </thead> <tbody> <tr> <td>pattern</td> <td>[1-9]</td> </tr> <tr> <td>enumeration</td> <td>2</td> </tr> <tr> <td>enumeration</td> <td>3</td> </tr> <tr> <td>enumeration</td> <td>4</td> </tr> <tr> <td>enumeration</td> <td>5</td> </tr> <tr> <td>enumeration</td> <td>6</td> </tr> <tr> <td>enumeration</td> <td>7</td> </tr> </tbody> </table>	Kind	Value	pattern	[1-9]	enumeration	2	enumeration	3	enumeration	4	enumeration	5	enumeration	6	enumeration	7
Kind	Value																
pattern	[1-9]																
enumeration	2																
enumeration	3																
enumeration	4																
enumeration	5																
enumeration	6																
enumeration	7																
source	<xs:element name="NumeroRate" minOccurs="0"> <xs:simpleType>																

	<pre> <xs:restriction base="cm:DatoN1_Type"> <xs:enumeration value="2"/> <xs:enumeration value="3"/> <xs:enumeration value="4"/> <xs:enumeration value="5"/> <xs:enumeration value="6"/> <xs:enumeration value="7"/> </xs:restriction> </xs:simpleType> </xs:element> </pre>
--	--

complexType **Mod730_Integrativo_Type**

diagram	
namespace	urn:www.agenziaentrate.gov.it:specificheTecniche:sco:730
children	m730:ImportiRimborsare m730:ImportoRimborsato m730:ImportoRimborsatoAgenzia m730:CasellaRimbAgenziaCasiPart
source	<pre> <xs:complexType name="Mod730_Integrativo_Type"> <xs:sequence> <xs:element name="ImportiRimborsare" type="m730:Importi_Rimborsare_730-4_Integrativo_Type"/> <xs:element name="ImportoRimborsato" type="cm:DatoNP_Type" minOccurs="0"/> <xs:element name="ImportoRimborsatoAgenzia" type="cm:DatoNP_Type" minOccurs="0"/> <xs:element name="CasellaRimbAgenziaCasiPart" type="cm:DatoCB_Type" minOccurs="0"/> </xs:sequence> </xs:complexType> </pre>

element **Mod730_Integrativo_Type/ImportiRimborsare**

diagram	
namespace	urn:www.agenziaentrate.gov.it:specificheTecniche:sco:730
type	m730:Importi_Rimborsare_730-4_Integrativo_Type

children	m730:IrpefRimborsare m730:AddRegRimborsare m730:AddComRimborsare m730:CedolareRimborsare m730:TassazioneSepRimborsare m730:IncrementoProduttivita m730:ContributoSolidarieta
source	<xs:element name="ImportiRimborsare" type="m730:Importi_Rimborsare_730-4_Integrativo_Type"/>

element **Mod730_Integrativo_Type/ImportoRimborsato**

diagram	
namespace	urn:www.agenziaentrate.gov.it:specificheTecniche:sco:730
type	DatoNP_Type
facets	Kind Value pattern [1-9]{1}[0-9]*
source	<xs:element name="ImportoRimborsato" type="cm:DatoNP_Type" minOccurs="0"/>

element **Mod730_Integrativo_Type/ImportoRimborsatoAgenzia**

diagram	
namespace	urn:www.agenziaentrate.gov.it:specificheTecniche:sco:730
type	DatoNP_Type
facets	Kind Value pattern [1-9]{1}[0-9]*
source	<xs:element name="ImportoRimborsatoAgenzia" type="cm:DatoNP_Type" minOccurs="0"/>

element **Mod730_Integrativo_Type/CasellaRimbAgenziaCasiPart**

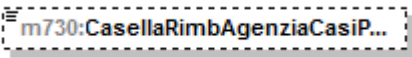
diagram	
namespace	urn:www.agenziaentrate.gov.it:specificheTecniche:sco:730
type	DatoCB_Type
facets	Kind Value pattern [01]
source	<xs:element name="CasellaRimbAgenziaCasiPart" type="cm:DatoCB_Type" minOccurs="0"/>

complexType **Modulo_Altri_Redditivi_Type**

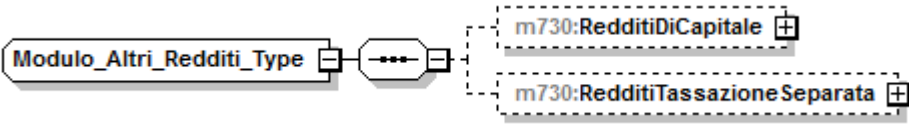
diagram	
namespace	urn:www.agenziaentrate.gov.it:specificheTecniche:sco:730
children	m730:RedditiDiCapitale m730:RedditiTassazioneSeparata
source	<xs:complexType name="Modulo_Altri_Redditivi_Type"> <xs:sequence> <xs:element name="RedditiDiCapitale" type="m730:Redditi_Capitale_Type" minOccurs="0"/> <xs:element name="RedditiTassazioneSeparata" type="m730:Redditi_Tassazione_Separata_Type" minOccurs="0"/> </xs:sequence> </xs:complexType>

element **Modulo_Altri_Reddit_Type/RedditiDiCapitale**

diagram	
namespace	urn:www.agenziaentrate.gov.it:specificheTecniche:sco:730
type	m730:Redditi_Capitale_Type
children	m730:Utili m730:AltriRedditiDiCapitale m730:LavoroAutonomo m730:RedditiDiversi m730:RedditiDiversiDetraz
source	<code><xs:element name="RedditiDiCapitale" type="m730:Redditi_Capitale_Type" minOccurs="0"/></code>

element **Modulo_Altri_Reddit_Type/RedditiTassazioneSeparata**

diagram	
namespace	urn:www.agenziaentrate.gov.it:specificheTecniche:sco:730
type	m730:Redditi_Tassazione_Separata_Type
children	m730:RedditiErede m730:ImposteRimborsate
source	<code><xs:element name="RedditiTassazioneSeparata" type="m730:Redditi_Tassazione_Separata_Type" minOccurs="0"/></code>

complexType **Modulo_Annotazioni_Type**

diagram	
namespace	urn:www.agenziaentrate.gov.it:specificheTecniche:sco:730
children	m730:Annotazione
source	<pre> <xs:complexType name="Modulo_Annotazioni_Type"> <xs:sequence> <xs:element name="Annotazione" type="m730:Annotazione_Type" maxOccurs="10"/> </xs:sequence> </xs:complexType> </pre>

element **Modulo_Anotazioni_Type/Annotazione**

diagram	
namespace	urn:www.agenziaentrate.gov.it:specificheTecniche:sco:730
type	m730:Annotazione_Type
children	m730:Codice m730:RigoQuadro m730:ModuloQuadro m730:Importo
source	<code><xs:element name="Annotazione" type="m730:Annotazione_Type" maxOccurs="10"/></code>

complexType **Modulo_Crediti_Imposta_Type**

diagram	
namespace	urn:www.agenziaentrate.gov.it:specificheTecniche:sco:730
children	m730:CreditoImpostaFondiPensione m730:CreditoImpostaRedditiEsteri m730:CreditoPrimaCasaSismaAbruzzo m730:CreditoAltriSismaAbruzzo
source	<pre> <xs:complexType name="Modulo_Crediti_Imposta_Type"> <xs:sequence> <xs:element name="CreditoImpostaFondiPensione" type="m730:Crediti_Imposta_Fondi_Pensione_Type" minOccurs="0"/> <xs:element name="CreditoImpostaRedditiEsteri" type="m730:Crediti_Imposta_Redditi_Esteri_Type" minOccurs="0"/> <xs:element name="CreditoPrimaCasaSismaAbruzzo" type="m730:Credito_Immobile_Sisma_Abruzzo_Type" minOccurs="0"/> <xs:element name="CreditoAltriSismaAbruzzo" type="m730:Crediti_Imposta_Altri_Sisma_Abruzzo_Type" minOccurs="0"/> </xs:sequence> </xs:complexType> </pre>

element **Modulo_Crediti_Imposta_Type/CreditiImpostaFondiPensione**

diagram	
namespace	urn:www.agenziaentrate.gov.it:specificheTecniche:sco:730
type	m730:Crediti_Imposta_Fondi_Pensione_Type
children	m730:AnnoAnticipazione m730:Reintegro m730:SommaReintegrata m730:CreditoAnno
source	<code><xs:element name="CreditiImpostaFondiPensione" type="m730:Crediti_Imposta_Fondi_Pensione_Type" minOccurs="0"/></code>

element **Modulo_Crediti_Imposta_Type/CreditiImpostaRedditiEsteri**

diagram	
namespace	urn:www.agenziaentrate.gov.it:specificheTecniche:sco:730
type	m730:Crediti_Imposta_Redditi_Esteri_Type
children	m730:StatoEstero m730:Anno m730:RedditoEstero m730:ImpostaEstera m730:RedditoComplessivo m730:Imposta_Lorda m730:ImpostaNetta m730:CreditoDichiarazioniPrecedenti m730:DiCuiStatoEstero
source	<code><xs:element name="CreditiImpostaRedditiEsteri" type="m730:Crediti_Imposta_Redditi_Esteri_Type" minOccurs="0"/></code>

element **Modulo_Crediti_Imposta_Type/CreditoPrimaCasaSismaAbruzzo**

diagram	
namespace	urn:www.agenziaentrate.gov.it:specificheTecniche:sco:730
type	m730:Credito_Immibile_Sisma_Abruzzo_Type
children	m730:CodiceFiscale m730:NumeroRata m730:TotaleCredito
source	<code><xs:element name="CreditoPrimaCasaSismaAbruzzo" type="m730:Credito_Immibile_Sisma_Abruzzo_Type" minOccurs="0"/></code>

element **Modulo_Crediti_Imposta_Type/CreditoAltriSismaAbruzzo**

diagram	
namespace	urn:www.agenziaentrate.gov.it:specificheTecniche:sco:730
type	m730:Crediti_Imposta_Altri_Sisma_Abruzzo_Type
children	m730:Impresa_Professione m730:CreditoImmibileSismaA... m730:Rateazione
source	<code><xs:element name="CreditoAltriSismaAbruzzo" type="m730:Crediti_Imposta_Altri_Sisma_Abruzzo_Type" minOccurs="0"/></code>

complexType **Modulo_Fabbricato_Type**

diagram	
namespace	urn:www.agenziaentrate.gov.it:specificheTecniche:sco:730
children	m730:FabbricatoOrd m730:FabbricatoAgev
source	<pre> <xs:complexType name="Modulo_Fabbricato_Type"> <xs:sequence> <xs:element name="FabbricatoOrd" type="m730:FabbricatoOrd_Type" minOccurs="0" maxOccurs="8"/> <xs:element name="FabbricatoAgev" type="m730:FabbricatoAgev_Type" minOccurs="0" maxOccurs="3"/> </xs:sequence> </xs:complexType> </pre>

element **Modulo_Fabbricato_Type/FabbricatoOrd**

<p>diagram</p>	
<p>namespace</p>	<p>urn:www.agenziaentrate.gov.it:specificheTecniche:sco:730</p>
<p>type</p>	<p>m730:FabbricatoOrd_Type</p>
<p>children</p>	<p>m730:Rendita m730:Utilizzo m730:GiorniPossesso m730:PercPossesso m730:CodiceCanone m730:CanoneLocazione m730:CasiParticolari m730:CasellaContinuazione m730:CodiceComune m730:OpzioneCedolare m730:CasellaCasiPartimu</p>
<p>source</p>	<p><xs:element name="FabbricatoOrd" type="m730:FabbricatoOrd_Type" minOccurs="0" maxOccurs="8"/></p>

element **Modulo_Fabbricato_Type/FabbricatoAgev**

<p>diagram</p>	
----------------	--

namespace	urn:www.agenziaentrate.gov.it:specificheTecniche:sco:730
type	m730:FabbricatoAgev_Type
children	m730:NumeroRigoRiferimento m730:NumModuloRiferimento m730:DatiContratto m730:CasellaInf30Giorni m730:AnnoDichiarazioneIcilmu m730:StatoEmergenza
source	<xs:element name="FabbricatoAgev" type="m730:FabbricatoAgev_Type" minOccurs="0" maxOccurs="3"/>

complexType **Modulo_Familiari_Type**

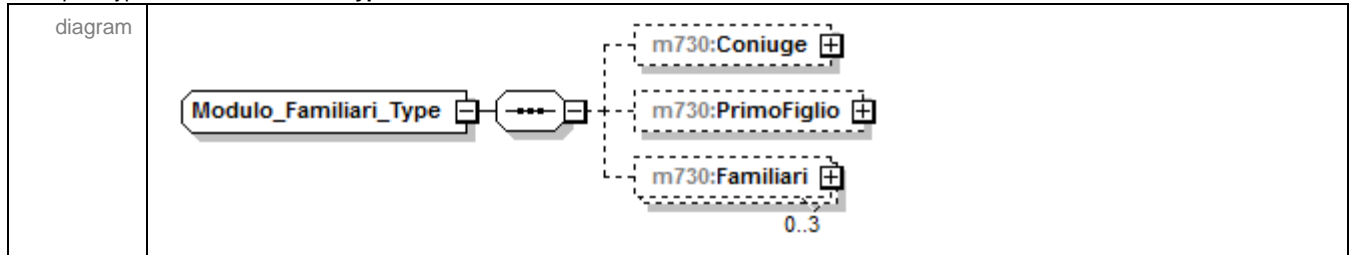

namespace	urn:www.agenziaentrate.gov.it:specificheTecniche:sco:730
-----------	--

children	m730:Coniuge m730:PrimoFiglio m730:Familiari
----------	--

source	<pre> <xs:complexType name="Modulo_Familiari_Type"> <xs:sequence> <xs:element name="Coniuge" type="m730:Dati_Coniuge_Type" minOccurs="0"/> <xs:element name="PrimoFiglio" minOccurs="0"> <xs:complexType> <xs:complexContent> <xs:extension base="m730:Dati_Familiare_Type"> <xs:sequence> <xs:element name="Tipo"> <xs:simpleType> <xs:restriction base="cm:DatoAN_Type"> <xs:enumeration value="F"/> <xs:enumeration value="D"/> </xs:restriction> </xs:simpleType> </xs:element> </xs:sequence> </xs:extension> </xs:complexContent> </xs:complexType> </xs:element> <xs:element name="Familiari" minOccurs="0" maxOccurs="3"> <xs:complexType> <xs:complexContent> <xs:extension base="m730:Dati_Familiare_Type"> <xs:sequence> <xs:element name="Tipo"> <xs:simpleType> <xs:restriction base="cm:DatoAN_Type"> <xs:enumeration value="F"/> <xs:enumeration value="D"/> <xs:enumeration value="A"/> </xs:restriction> </xs:simpleType> </xs:element> </xs:sequence> </xs:extension> </xs:complexContent> </xs:complexType> </xs:element> </xs:sequence> </xs:complexType> </pre>
--------	--

element **Modulo_Familiari_Type/Coniuge**

diagram	
namespace	urn:www.agenziaentrate.gov.it:specificheTecniche:sco:730
type	m730:Dati_Coniuge_Type
children	m730:Tipo m730:CodiceFiscale m730:Mesi
source	<code><xs:element name="Coniuge" type="m730:Dati_Coniuge_Type" minOccurs="0"/></code>

element **Modulo_Familiari_Type/PrimoFiglio**

diagram	
namespace	urn:www.agenziaentrate.gov.it:specificheTecniche:sco:730
type	extension of m730:Dati_Familiare_Type
children	m730:CodiceFiscale m730:Mesi m730:MesiMinore m730:PercDetraz m730:PercDetrazCon m730:Affidamento m730:Tipo
source	<pre> <xs:element name="PrimoFiglio" minOccurs="0"> <xs:complexType> <xs:complexContent> <xs:extension base="m730:Dati_Familiare_Type"> <xs:sequence> <xs:element name="Tipo"> <xs:simpleType> <xs:restriction base="cm:DatoAN_Type"> <xs:enumeration value="F"/> <xs:enumeration value="D"/> </xs:restriction> </xs:simpleType> </xs:element> <xs:element name="PrimoFiglioData"> <xs:complexType base="cm:DatoAN_Type"> <xs:sequence> <xs:element name="PercDetraz" type="cm:DatoAN_Type"/> <xs:element name="PercDetrazCon" type="cm:DatoAN_Type"/> </xs:sequence> </xs:complexType> </xs:element> <xs:element name="Affidamento" type="cm:DatoAN_Type"/> </xs:sequence> </xs:extension> </xs:complexContent> </xs:complexType> </xs:element> </pre>

	<pre> </xs:extension> </xs:complexContent> </xs:complexType> </xs:element> </pre>
--	---

element **Modulo_Familiari_Type/PrimoFiglio/Tipo**

diagram									
namespace	urn:www.agenziaentrate.gov.it:specificheTecniche:sco:730								
type	restriction of DatoAN_Type								
facets	<table border="0"> <tr> <td>Kind</td> <td>Value</td> </tr> <tr> <td>pattern</td> <td>{([0-9A-Z-])&quot;}{1}([0-9A-Z&amp;:] ' \" / ° ^\(\\ \\) À É Ê Ï Ò Ù Ü &quot; \\ \\ \\ +)*</td> </tr> <tr> <td>enumeration</td> <td>F</td> </tr> <tr> <td>enumeration</td> <td>D</td> </tr> </table>	Kind	Value	pattern	{([0-9A-Z-])"}{1}([0-9A-Z&:] ' \" / ° ^\(\\ \\) À É Ê Ï Ò Ù Ü " \\ \\ \\ +)*	enumeration	F	enumeration	D
Kind	Value								
pattern	{([0-9A-Z-])"}{1}([0-9A-Z&:] ' \" / ° ^\(\\ \\) À É Ê Ï Ò Ù Ü " \\ \\ \\ +)*								
enumeration	F								
enumeration	D								
source	<pre> <xs:element name="Tipo"> <xs:simpleType> <xs:restriction base="cm:DatoAN_Type"> <xs:enumeration value="F"/> <xs:enumeration value="D"/> </xs:restriction> </xs:simpleType> </xs:element> </pre>								

element **Modulo_Familiari_Type/Familiari**

diagram	
namespace	urn:www.agenziaentrate.gov.it:specificheTecniche:sco:730
type	extension of m730:Dati_Familiare_Type
children	m730:CodiceFiscale m730:Mesi m730:MesiMinore m730:PercDetraz m730:PercDetrazCon m730:Affidamento m730:Tipo
source	<pre> <xs:element name="Familiari" minOccurs="0" maxOccurs="3"> <xs:complexType> <xs:complexContent> <xs:extension base="m730:Dati_Familiare_Type"> <xs:sequence> <xs:element name="Tipo"> <xs:simpleType> <xs:restriction base="cm:DatoAN_Type"> </pre>

	<pre> <xs:enumeration value="F"/> <xs:enumeration value="D"/> <xs:enumeration value="A"/> </xs:restriction> </xs:simpleType> </xs:element> </xs:sequence> </xs:extension> </xs:complexContent> </xs:complexType> </xs:element> </pre>
--	---

element **Modulo_Familiari_Type/Familiari/Tipo**

diagram											
namespace	urn:www.agenziaentrate.gov.it:specificheTecniche:sco:730										
type	restriction of DatoAN_Type										
facets	<table border="1"> <thead> <tr> <th>Kind</th> <th>Value</th> </tr> </thead> <tbody> <tr> <td>pattern</td> <td>([0-9A-Z\-\-] \&quot;){1}([0-9A-Z&amp;:] \- \., / \° \v\(\) \À \É \ \Ò \Ù \ &quot; \N \ +)*</td> </tr> <tr> <td>enumeration</td> <td>F</td> </tr> <tr> <td>enumeration</td> <td>D</td> </tr> <tr> <td>enumeration</td> <td>A</td> </tr> </tbody> </table>	Kind	Value	pattern	([0-9A-Z\-\-] \"){1}([0-9A-Z&:] \- \., / \° \v\(\) \À \É \ \Ò \Ù \ " \N \ +)*	enumeration	F	enumeration	D	enumeration	A
Kind	Value										
pattern	([0-9A-Z\-\-] \"){1}([0-9A-Z&:] \- \., / \° \v\(\) \À \É \ \Ò \Ù \ " \N \ +)*										
enumeration	F										
enumeration	D										
enumeration	A										
source	<pre> <xs:element name="Tipo"> <xs:simpleType> <xs:restriction base="cm:DatoAN_Type"> <xs:enumeration value="F"/> <xs:enumeration value="D"/> <xs:enumeration value="A"/> </xs:restriction> </xs:simpleType> </xs:element> </pre>										

complexType **Modulo_Lavoro_Dip_Type**

diagram	
namespace	urn:www.agenziaentrate.gov.it:specificheTecniche:sco:730
children	m730:LavoroDipendente m730:AltriRedditiAssLavDip
source	<pre> <xs:complexType name="Modulo_Lavoro_Dip_Type"> <xs:sequence> <xs:element name="LavoroDipendente" type="m730:Lavoro_Dipendente_Type" minOccurs="0" maxOccurs="3"/> <xs:element name="AltriRedditiAssLavDip" type="m730:Altri_Redditi_Ass_Lavd_Type" minOccurs="0" maxOccurs="3"/> </xs:sequence> </xs:complexType> </pre>

element **Modulo_Lavoro_Dip_Type/LavoroDipendente**

diagram	
namespace	urn:www.agenziaentrate.gov.it:specificheTecniche:sco:730
type	m730:Lavoro_Dipendente_Type
children	m730:TipologiaReddito m730:TipoContratto m730:Reddito
source	<code><xs:element name="LavoroDipendente" type="m730:Lavoro_Dipendente_Type" minOccurs="0" maxOccurs="3"/></code>

element **Modulo_Lavoro_Dip_Type/AltriRedditiAssLavDip**

diagram	
namespace	urn:www.agenziaentrate.gov.it:specificheTecniche:sco:730
type	m730:Altri_Redditi_Ass_Lavd_Type
children	m730:AssegnoDelConiuge m730:ImportoRedditoAssimilato
source	<code><xs:element name="AltriRedditiAssLavDip" type="m730:Altri_Redditi_Ass_Lavd_Type" minOccurs="0" maxOccurs="3"/></code>

complexType **Modulo_Oneri_Type**

<p>diagram</p>	
<p>namespace</p>	<p>urn:www.agenziaentrate.gov.it:specificheTecniche:sco:730</p>
<p>children</p>	<p>m730:SpeseDetrazioni m730:SpeseDeduzioni m730:InterventoRecuperoPatrimonioEdilizio m730:DatiCatastaliRecuperoPatrimonioEdilizio m730:InterventoRisparmioEnergetico m730:CanoniLocazione m730:DatiAltreDetrazioni m730:SpeseArredo</p>
<p>source</p>	<pre><xs:complexType name="Modulo_Oneri_Type"> <xs:sequence> <xs:element name="SpeseDetrazioni" type="m730:Detrazioni_Modulo_Type" minOccurs="0"/> <xs:element name="SpeseDeduzioni" type="m730:Deduzioni_Modulo_Type" minOccurs="0"/> <xs:element name="InterventoRecuperoPatrimonioEdilizio" type="m730:Intervento_Recupero_Patrimonio_Edilizio_Type" minOccurs="0" maxOccurs="4"/> <xs:element name="DatiCatastaliRecuperoPatrimonioEdilizio" type="m730:Sezione_Dati_Catastali_Recupero_Patrimonio_Edilizio_Type" minOccurs="0"/> <xs:element name="InterventoRisparmioEnergetico" type="m730:Intervento_Risparmio_Energetico_Type" minOccurs="0" maxOccurs="3"/> <xs:element name="CanoniLocazione" type="m730:Detrazioni_Canoni_Locazione_Type" minOccurs="0"/> <xs:element name="DatiAltreDetrazioni" type="m730:Dati_Altre_Detrazioni_Modulo_Type" minOccurs="0"/> <xs:element name="SpeseArredo" type="m730:Spese_Arredo_Type" minOccurs="0" maxOccurs="2"/> </xs:sequence> </xs:complexType></pre>

element **Modulo_Oneri_Type/SpeseDetrazioni**

<p>diagram</p>	
----------------	--

namespace	urn:www.agenziaentrate.gov.it:specificheTecniche:sco:730
type	m730:Detrazioni Modulo Type
children	m730:VeicoliDisabili m730:AcquistoCaniGuida m730:SpeseRateizzate m730:AltreSpese
source	<xs:element name="SpeseDetrazioni" type="m730:Detrazioni_Modulo_Type" minOccurs="0"/>

element **Modulo_Oneri_Type/SpeseDeduzioni**

diagram	<pre> classDiagram class m730SpeseDeduzioni class m730DetrazioniModuloType["m730:Detrazioni_Modulo_Type"] class m730AssegnoConiuge class m730AltriOneri class m730AcquistoCostruzioneAbitLocazione["m730:AcquistoCostruzioneAbitLocazione"] m730SpeseDeduzioni -- m730DetrazioniModuloType m730DetrazioniModuloType -- m730AssegnoConiuge m730DetrazioniModuloType -- m730AltriOneri m730DetrazioniModuloType -- m730AcquistoCostruzioneAbitLocazione </pre>
namespace	urn:www.agenziaentrate.gov.it:specificheTecniche:sco:730
type	m730:Deduzioni Modulo Type
children	m730:AssegnoConiuge m730:AltriOneri m730:AcquistoCostruzioneAbitLocazione
source	<xs:element name="SpeseDeduzioni" type="m730:Deduzioni_Modulo_Type" minOccurs="0"/>

element **Modulo_Oneri_Type/InterventoRecuperoPatrimonioEdilizio**

diagram	<pre> classDiagram class m730InterventoRecuperoPatrimonioEdilizio["m730:InterventoRecuperoPatri..."] class m730InterventoRecuperoPatrimonioEdilizioType["m730:Intervento_Recupero_Patrimonio_Edilizio_Type"] class m730Anno class m730Periodo class m730CodiceFiscale class m730CasellaInterventiParticolari class m730CodiceSituazioniParticolari class m730AnnoSituazioniParticolari class m730RideterminazioneRate class m730NRate class m730Spesa class m730NOrdineImmobile m730InterventoRecuperoPatrimonioEdilizio -- m730InterventoRecuperoPatrimonioEdilizioType m730InterventoRecuperoPatrimonioEdilizioType -- m730Anno m730InterventoRecuperoPatrimonioEdilizioType -- m730Periodo m730InterventoRecuperoPatrimonioEdilizioType -- m730CodiceFiscale m730InterventoRecuperoPatrimonioEdilizioType -- m730CasellaInterventiParticolari m730InterventoRecuperoPatrimonioEdilizioType -- m730CodiceSituazioniParticolari m730InterventoRecuperoPatrimonioEdilizioType -- m730AnnoSituazioniParticolari m730InterventoRecuperoPatrimonioEdilizioType -- m730RideterminazioneRate m730InterventoRecuperoPatrimonioEdilizioType -- m730NRate m730InterventoRecuperoPatrimonioEdilizioType -- m730Spesa m730InterventoRecuperoPatrimonioEdilizioType -- m730NOrdineImmobile </pre>
namespace	urn:www.agenziaentrate.gov.it:specificheTecniche:sco:730
type	m730:Intervento Recupero Patrimonio Edilizio Type

children	m730:Anno m730:Periodo m730:CodiceFiscale m730:CasellaInterventiParticolari m730:CodiceSituazioniParticolari m730:AnnoSituazioniParticolari m730:RideterminazioneRate m730:NRate m730:Spesa m730:NOrdinImmobile
source	<code><xs:element name="InterventoRecuperoPatrimonioEdilizio" type="m730:Intervento_Recupero_Patrimonio_Edilizio_Type" minOccurs="0" maxOccurs="4"/></code>

element **Modulo_Oneri_Type/DatiCatastaliRecuperoPatrimonioEdilizio**

diagram	
namespace	urn:www.agenziaentrate.gov.it:specificheTecniche:sco:730
type	m730:Sezione Dati Catastali Recupero Patrimonio Edilizio Type
children	m730:DatiCatastaliRecuperoPatrimonioEdilizio m730:DatiRegistrazioneAccatastamentoRecuperoPatrimonio Edilizio
source	<code><xs:element name="DatiCatastaliRecuperoPatrimonioEdilizio" type="m730:Sezione_Dati_Catastali_Recupero_Patrimonio_Edilizio_Type" minOccurs="0"/></code>

element **Modulo_Oneri_Type/InterventoRisparmioEnergetico**

diagram	
namespace	urn:www.agenziaentrate.gov.it:specificheTecniche:sco:730
type	m730:Intervento Risparmio Energetico Type
children	m730:TipoIntervento m730:Anno m730:Periodo2013 m730:CasiParticolari m730:RideterminazioneRate m730:RipartizioneRate m730:NumeroRata m730:Spesa
source	<code><xs:element name="InterventoRisparmioEnergetico" type="m730:Intervento_Risparmio_Energetico_Type" minOccurs="0" maxOccurs="3"/></code>

element **Modulo_Oneri_Type/CanoniLocazione**

diagram	
namespace	urn:www.agenziaentrate.gov.it:specificheTecniche:sco:730
type	m730:Detrazioni_Canoni_Locazione_Type
children	m730:InquiliniAbitazionePrincipale m730:DipendentiTrasferiti
source	<code><xs:element name="CanoniLocazione" type="m730:Detrazioni_Canoni_Locazione_Type" minOccurs="0"/></code>

element **Modulo_Oneri_Type/DatiAltreDetrazioni**

diagram	
namespace	urn:www.agenziaentrate.gov.it:specificheTecniche:sco:730
type	m730:Dati_Altre_Detrazioni_Modulo_Type
children	m730:AltreDetrazioni
source	<code><xs:element name="DatiAltreDetrazioni" type="m730:Dati_Altre_Detrazioni_Modulo_Type" minOccurs="0"/></code>

element **Modulo_Oneri_Type/SpeseArredo**

diagram	
namespace	urn:www.agenziaentrate.gov.it:specificheTecniche:sco:730
type	m730:Spese_Arredo_Type
children	m730:NumeroRata m730:Importo
source	<code><xs:element name="SpeseArredo" type="m730:Spese_Arredo_Type" minOccurs="0" maxOccurs="2"/></code>

complexType **Modulo_PL_Type**

diagram	
namespace	urn:www.agenziaentrate.gov.it:specificheTecniche:sco:730
children	m730:CredImpEsteri
source	<code><xs:complexType name="Modulo_PL_Type"> <xs:sequence></code>

	<pre><xs:element name="CredImpEstero" type="m730:Cred_Imp_Estero_Type" minOccurs="0"/> </xs:sequence> </xs:complexType></pre>
--	---

element **Modulo_PL_Type/CredImpEstero**

diagram	
namespace	urn:www.agenziaentrate.gov.it:specificheTecniche:sco:730
type	m730:Cred_Imp_Estero_Type
children	m730:Anno m730:TotCredito m730:CreditoStato
source	<pre><xs:element name="CredImpEstero" type="m730:Cred_Imp_Estero_Type" minOccurs="0"/></pre>

complexType **Modulo_Terreno_Type**

diagram	
namespace	urn:www.agenziaentrate.gov.it:specificheTecniche:sco:730
children	m730:Terreno
source	<pre><xs:complexType name="Modulo_Terreno_Type"> <xs:sequence> <xs:element name="Terreno" type="m730:Terreno_Type" maxOccurs="8"/> </xs:sequence> </xs:complexType></pre>

element **Modulo_Terreno_Type/Terreno**

diagram	
namespace	urn:www.agenziaentrate.gov.it:specificheTecniche:sco:730
type	m730:Terreno_Type
children	m730:RedDominicale m730:Titolo m730:RedAgrario m730:GiorniPossesso m730:PercPossesso m730:CanoneVincolistico m730:CasiParticolari m730:CasellaContinuazione m730:CasellalmuNonDovuta m730:CasellaColtivatoreDiretto
source	<code><xs:element name="Terreno" type="m730:Terreno_Type" maxOccurs="8"/></code>

complexType **N_Rate_Type**

diagram	
namespace	urn:www.agenziaentrate.gov.it:specificheTecniche:sco:730
children	m730:Rate5 m730:Rate10
source	<pre> <xs:complexType name="N_Rate_Type"> <xs:choice> <xs:element name="Rate5" type="m730:Rate5_Type" minOccurs="0"/> <xs:element name="Rate10" type="m730:Rate10_Type" minOccurs="0"/> </xs:choice> </xs:complexType> </pre>

element **N_Rate_Type/Rate5**

diagram	
---------	--

namespace	urn:www.agenziaentrate.gov.it:specificheTecniche:sco:730								
type	m730:Rate5_Type								
facets	<table border="0"> <tr> <td>Kind</td> <td>Value</td> </tr> <tr> <td>pattern</td> <td>[1-9]{1}[0-9]*</td> </tr> <tr> <td>enumeration</td> <td>4</td> </tr> <tr> <td>enumeration</td> <td>5</td> </tr> </table>	Kind	Value	pattern	[1-9]{1}[0-9]*	enumeration	4	enumeration	5
Kind	Value								
pattern	[1-9]{1}[0-9]*								
enumeration	4								
enumeration	5								
source	<xs:element name="Rate5" type="m730:Rate5_Type" minOccurs="0"/>								

element **N_Rate_Type/Rate10**

diagram																									
namespace	urn:www.agenziaentrate.gov.it:specificheTecniche:sco:730																								
type	m730:Rate10_Type																								
facets	<table border="0"> <tr> <td>Kind</td> <td>Value</td> </tr> <tr> <td>pattern</td> <td>[1-9]{1}[0-9]*</td> </tr> <tr> <td>enumeration</td> <td>1</td> </tr> <tr> <td>enumeration</td> <td>2</td> </tr> <tr> <td>enumeration</td> <td>3</td> </tr> <tr> <td>enumeration</td> <td>4</td> </tr> <tr> <td>enumeration</td> <td>5</td> </tr> <tr> <td>enumeration</td> <td>6</td> </tr> <tr> <td>enumeration</td> <td>7</td> </tr> <tr> <td>enumeration</td> <td>8</td> </tr> <tr> <td>enumeration</td> <td>9</td> </tr> <tr> <td>enumeration</td> <td>10</td> </tr> </table>	Kind	Value	pattern	[1-9]{1}[0-9]*	enumeration	1	enumeration	2	enumeration	3	enumeration	4	enumeration	5	enumeration	6	enumeration	7	enumeration	8	enumeration	9	enumeration	10
Kind	Value																								
pattern	[1-9]{1}[0-9]*																								
enumeration	1																								
enumeration	2																								
enumeration	3																								
enumeration	4																								
enumeration	5																								
enumeration	6																								
enumeration	7																								
enumeration	8																								
enumeration	9																								
enumeration	10																								
source	<xs:element name="Rate10" type="m730:Rate10_Type" minOccurs="0"/>																								

complexType **Oneri_Non_Abbattuti_Type**

diagram	
namespace	urn:www.agenziaentrate.gov.it:specificheTecniche:sco:730
children	m730:DetrazSpeseAssPersonale m730:DetrazErogazBiennaleVenezia m730:DetrazErogazSpettacolo m730:DetrazErogazSettoreMusicale m730:DeduzContributiPaesiSviluppo m730:DeduzOnlus m730:DetrazOspedaleGalliera m730:PrevidenzaCompDipPubbli... m730:InteressiMutuiAgrari m730:ArtBonus

	m730:DetrazOspedaleGalliera m730:PrevidenzaComplDipPubblici m730:InteressiMutuiAgrari m730:ArtBonus
source	<pre><xs:complexType name="Oneri_Non_Abbattuti_Type"> <xs:sequence> <xs:element name="DetrazSpeseAssPersonale" type="cm:DatoNP_Type" minOccurs="0"/> <xs:element name="DetrazErogazBiennaleVenezia" type="cm:DatoNP_Type" minOccurs="0"/> <xs:element name="DetrazErogazSpettacolo" type="cm:DatoNP_Type" minOccurs="0"/> <xs:element name="DetrazErogazSettoreMusicale" type="cm:DatoNP_Type" minOccurs="0"/> <xs:element name="DeduzContributiPaesiSviluppo" type="cm:DatoNP_Type" minOccurs="0"/> <xs:element name="DeduzOnlus" type="cm:DatoNP_Type" minOccurs="0"/> <xs:element name="DetrazOspedaleGalliera" type="cm:DatoNP_Type" minOccurs="0"/> <xs:element name="PrevidenzaComplDipPubblici" type="cm:DatoNP_Type" minOccurs="0"/> <xs:element name="InteressiMutuiAgrari" type="cm:DatoNP_Type" minOccurs="0"/> <xs:element name="ArtBonus" type="cm:DatoNP_Type" minOccurs="0"/> </xs:sequence> </xs:complexType></pre>

element [Oneri_Non_Abbattuti_Type/DetrazSpeseAssPersonale](#)

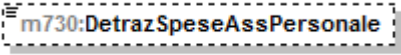
diagram					
namespace	urn:www.agenziaentrate.gov.it:specificheTecniche:sco:730				
type	DatoNP_Type				
facets	<table border="1"> <tr> <td>Kind</td> <td>Value</td> </tr> <tr> <td>pattern</td> <td>[1-9]{1}[0-9]*</td> </tr> </table>	Kind	Value	pattern	[1-9]{1}[0-9]*
Kind	Value				
pattern	[1-9]{1}[0-9]*				
source	<pre><xs:element name="DetrazSpeseAssPersonale" type="cm:DatoNP_Type" minOccurs="0"/></pre>				

element [Oneri_Non_Abbattuti_Type/DetrazErogazBiennaleVenezia](#)

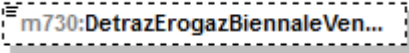
diagram					
namespace	urn:www.agenziaentrate.gov.it:specificheTecniche:sco:730				
type	DatoNP_Type				
facets	<table border="1"> <tr> <td>Kind</td> <td>Value</td> </tr> <tr> <td>pattern</td> <td>[1-9]{1}[0-9]*</td> </tr> </table>	Kind	Value	pattern	[1-9]{1}[0-9]*
Kind	Value				
pattern	[1-9]{1}[0-9]*				
source	<pre><xs:element name="DetrazErogazBiennaleVenezia" type="cm:DatoNP_Type" minOccurs="0"/></pre>				

element [Oneri_Non_Abbattuti_Type/DetrazErogazSpettacolo](#)

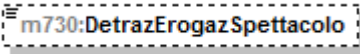
diagram					
namespace	urn:www.agenziaentrate.gov.it:specificheTecniche:sco:730				
type	DatoNP_Type				
facets	<table border="1"> <tr> <td>Kind</td> <td>Value</td> </tr> <tr> <td>pattern</td> <td>[1-9]{1}[0-9]*</td> </tr> </table>	Kind	Value	pattern	[1-9]{1}[0-9]*
Kind	Value				
pattern	[1-9]{1}[0-9]*				
source	<pre><xs:element name="DetrazErogazSpettacolo" type="cm:DatoNP_Type" minOccurs="0"/></pre>				

element [Oneri_Non_Abbattuti_Type/DetrazErogazSettoreMusicale](#)

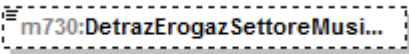
diagram	
namespace	urn:www.agenziaentrate.gov.it:specificheTecniche:sco:730
type	DatoNP_Type

facets	Kind Value pattern [1-9]{1}[0-9]*
source	<xs:element name="DetrazErogazSettoreMusicale" type="cm:DatoNP_Type" minOccurs="0"/>

element **Oneri_Non_Abbattuti_Type/DeduzContributiPaesiSviluppo**

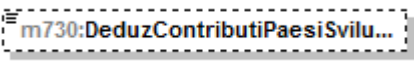
diagram	
namespace	urn:www.agenziaentrate.gov.it:specificheTecniche:sco:730
type	DatoNP_Type
facets	Kind Value pattern [1-9]{1}[0-9]*
source	<xs:element name="DeduzContributiPaesiSviluppo" type="cm:DatoNP_Type" minOccurs="0"/>

element **Oneri_Non_Abbattuti_Type/DeduzOnlus**

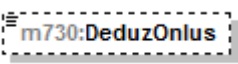
diagram	
namespace	urn:www.agenziaentrate.gov.it:specificheTecniche:sco:730
type	DatoNP_Type
facets	Kind Value pattern [1-9]{1}[0-9]*
source	<xs:element name="DeduzOnlus" type="cm:DatoNP_Type" minOccurs="0"/>

element **Oneri_Non_Abbattuti_Type/DetrazOspedaleGalliera**

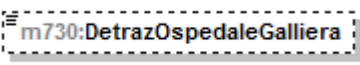
diagram	
namespace	urn:www.agenziaentrate.gov.it:specificheTecniche:sco:730
type	DatoNP_Type
facets	Kind Value pattern [1-9]{1}[0-9]*
source	<xs:element name="DetrazOspedaleGalliera" type="cm:DatoNP_Type" minOccurs="0"/>

element **Oneri_Non_Abbattuti_Type/PrevidenzaComplDipPubblici**

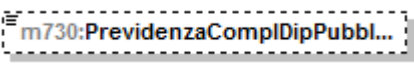
diagram	
namespace	urn:www.agenziaentrate.gov.it:specificheTecniche:sco:730
type	DatoNP_Type
facets	Kind Value pattern [1-9]{1}[0-9]*
source	<xs:element name="PrevidenzaComplDipPubblici" type="cm:DatoNP_Type" minOccurs="0"/>

element **Oneri_Non_Abbattuti_Type/InteressiMutuiAgrari**

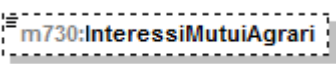
diagram	
namespace	urn:www.agenziaentrate.gov.it:specificheTecniche:sco:730

type	DatoNP_Type
facets	Kind Value pattern [1-9]{1}[0-9]*
source	<code><xs:element name="InteressiMutuiAgrari" type="cm:DatoNP_Type" minOccurs="0"/></code>

element **Oneri_Non_Abbattuti_Type/ArtBonus**

diagram	
namespace	urn:www.agenziaentrate.gov.it:specificheTecniche:sco:730
type	DatoNP_Type
facets	Kind Value pattern [1-9]{1}[0-9]*
source	<code><xs:element name="ArtBonus" type="cm:DatoNP_Type" minOccurs="0"/></code>

complexType **Oneri_Type**

diagram	
namespace	urn:www.agenziaentrate.gov.it:specificheTecniche:sco:730
children	m730:PrimoModulo m730:Modulo
source	<code><xs:complexType name="Oneri_Type"> <xs:sequence> <xs:element name="PrimoModulo" type="m730:PrimoModulo_Oneri_Type"/> <xs:element name="Modulo" type="m730:Modulo_Oneri_Type" minOccurs="0" maxOccurs="unbounded"/> </xs:sequence> </xs:complexType></code>

element **Oneri_Type/PrimoModulo**

<p>diagram</p>	<p>The diagram illustrates the structure of the <code>m730:PrimoModulo</code> element. It is composed of a container element <code>m730:PrimoModulo_Oneri_Type</code>, which is highlighted in yellow. This container includes the following sub-elements:</p> <ul style="list-style-type: none"> <code>m730:SpeseDetrazioni</code> <code>m730:SpeseDeduzioni</code> <code>m730:InterventoRecuperoPatri...</code> (multiplicity: 0..4) <code>m730:DatiCatastaliRecuperoPat...</code> (multiplicity: 0..3) <code>m730:InterventoRisparmioEner...</code> (multiplicity: 0..3) <code>m730:CanoniLocazione</code> <code>m730:DatiAltreDetrazioni</code> <code>m730:OneriNonAbbattuti</code> <code>m730:SpeseArredo</code> (multiplicity: 0..2)
<p>namespace</p>	<p>urn:www.agenziaentrate.gov.it:specificheTecniche:sco:730</p>
<p>type</p>	<p>m730:PrimoModulo_Oneri_Type</p>
<p>children</p>	<p>m730:SpeseDetrazioni m730:SpeseDeduzioni m730:InterventoRecuperoPatrimonioEdilizio m730:DatiCatastaliRecuperoPatrimonioEdilizio m730:InterventoRisparmioEnergetico m730:CanoniLocazione m730:DatiAltreDetrazioni m730:OneriNonAbbattuti m730:SpeseArredo</p>
<p>source</p>	<p><code><xs:element name="PrimoModulo" type="m730:PrimoModulo_Oneri_Type"/></code></p>

element **Oneri_Type/Modulo**

diagram	
namespace	urn:www.agenziaentrate.gov.it:specificheTecniche:sco:730
type	m730:Modulo_Oneri_Type
children	m730:SpeseDetrazioni m730:SpeseDeduzioni m730:InterventoRecuperoPatrimonioEdilizio m730:DatiCatastaliRecuperoPatrimonioEdilizio m730:InterventoRisparmioEnergetico m730:CanoniLocazione m730:DatiAltreDetrazioni m730:SpeseArredo
source	<code><xs:element name="Modulo" type="m730:Modulo_Oneri_Type" minOccurs="0" maxOccurs="unbounded"/></code>

complexType **Opzione_Produttivita_Type**

diagram	
namespace	urn:www.agenziaentrate.gov.it:specificheTecniche:sco:730
source	<code><xs:complexType name="Opzione_Produttivita_Type"/></code>

complexType **Periodo_Di_Lavoro_Type**

diagram	
namespace	urn:www.agenziaentrate.gov.it:specificheTecniche:sco:730
children	m730:GiorniLavoroDipendente m730:GiorniPensione
source	<code><xs:complexType name="Periodo_Di_Lavoro_Type"> <xs:sequence> <xs:element name="GiorniLavoroDipendente" type="cm:DatoGA_Type" minOccurs="0"/> <xs:element name="GiorniPensione" type="cm:DatoGA_Type" minOccurs="0"/> </xs:sequence> </xs:complexType></code>

	<pre></xs:sequence> </xs:complexType></pre>
--	---

element **Periodo_Di_Lavoro_Type/GiorniLavoroDipendente**

diagram	
namespace	urn:www.agenziaentrate.gov.it:specificheTecniche:sco:730
type	DatoGA Type
facets	Kind Value pattern [1-9](((1-9)[0-9]) ((12)[0-9][0-9]) (3[0-5][0-9]) (36[0-5]))
source	<pre><xs:element name="GiorniLavoroDipendente" type="cm:DatoGA_Type" minOccurs="0"/></pre>

element **Periodo_Di_Lavoro_Type/GiorniPensione**

diagram	
namespace	urn:www.agenziaentrate.gov.it:specificheTecniche:sco:730
type	DatoGA Type
facets	Kind Value pattern [1-9](((1-9)[0-9]) ((12)[0-9][0-9]) (3[0-5][0-9]) (36[0-5]))
source	<pre><xs:element name="GiorniPensione" type="cm:DatoGA_Type" minOccurs="0"/></pre>

complexType **Primo_Modulo_Acconti_Ritenute_Type**

diagram	
namespace	urn:www.agenziaentrate.gov.it:specificheTecniche:sco:730
children	m730:Accontilrpef m730:AltreRitenute m730:Eccedenze m730:RitenuteAccontiSospesi m730:MisuraAcconti m730:EsenzioneAddComunale m730:Dati730Integrativo m730:AccontiAltriDati
source	<pre><xs:complexType name="Primo_Modulo_Acconti_Ritenute_Type"> <xs:sequence> <xs:element name="Accontilrpef" type="m730:Acconti_Irpef_Anno_Imposta_Type" minOccurs="0"/> <xs:element name="AltreRitenute" type="m730:Altre_Ritenute_Type" minOccurs="0"/> <xs:element name="Eccedenze" type="m730:Eccedenze_Type" minOccurs="0"/> <xs:element name="RitenuteAccontiSospesi" type="m730:Ritenute_Acconti_Sospesi_Type" minOccurs="0"/> <xs:element name="MisuraAcconti" type="m730:Misura_Acconti_Type" minOccurs="0"/> <xs:element name="EsenzioneAddComunale" type="m730:Esenzione_Add_Comunale_Type" minOccurs="0"/> </xs:sequence> </xs:complexType></pre>

	<pre> <xs:element name="Dati730Integrativo" type="m730:Dati_730Integrativo_Type" minOccurs="0"/> <xs:element name="AccontiAltriDati" type="m730:Acconti_Altri_Dati_Type" minOccurs="0"/> </xs:sequence> </xs:complexType> </pre>
--	--

element **Primo Modulo Acconti Ritenute Type/Accontilrpef**

diagram	
namespace	urn:www.agenziaentrate.gov.it:specificheTecniche:sco:730
type	m730:Acconti_Irpef_Anno_Imposta_Type
children	m730:PrimaRataAccontilrpef m730:SecondaRataAccontilrpef m730:AccontoAddComunale m730:AccontoAddComunaleF24 m730:PrimaRataAccontoCedolare m730:SecondaRataAccontoCedolare
source	<pre><xs:element name="Accontilrpef" type="m730:Acconti_Irpef_Anno_Imposta_Type" minOccurs="0"/></pre>

element **Primo Modulo Acconti Ritenute Type/AltreRitenute**

diagram	
namespace	urn:www.agenziaentrate.gov.it:specificheTecniche:sco:730
type	m730:Altre_Ritenute_Type
children	m730:AltreRitenuteIrpef m730:AddizionaleRegionale m730:AddizionaleComunale m730:AddRegionaleIrpefAttivitaSport m730:AddComunaleIrpefAttivitaSport m730:IrpefLavoriSocialmenteUtili

	m730:AddRegionaleIrpefLavoriSoc_Utili
source	<xs:element name="AltreRitenute" type="m730:Altre_Ritenute_Type" minOccurs="0"/>

element **Primo_Modulo_Aconti_Ritenute_Type/Eccedenze**

diagram	
namespace	urn:www.agenziaentrate.gov.it:specificheTecniche:sco:730
type	m730:Eccedenze Type
children	m730:Irpef m730:IrpefCompF24 m730:SostitutivaQuadroRT m730:SostitutivaQuadroRTcompF24 m730:CedolareSecca m730:CedolareSeccaCompF24 m730:CodiceRegione m730:AddRegionaleIrpef m730:AddRegionaleIrpefCompF24 m730:CodiceCatastaleComune m730:AddComunaleIrpef m730:AddComunaleIrpefF24
source	<xs:element name="Eccedenze" type="m730:Eccedenze_Type" minOccurs="0"/>

element **Primo_Modulo_Acconti_Ritenute_Type/RitenuteAccontiSospesi**

<p>diagram</p>	
<p>namespace</p>	<p>urn:www.agenziaentrate.gov.it:specificheTecniche:sco:730</p>
<p>type</p>	<p>m730:Ritenute_Acconti_Sospesi_Type</p>
<p>children</p>	<p>m730:CodiceEvento m730:Irpef m730:AddRegionaleIrpef m730:AddComunaleIrpef m730:SostitutivaProduttivita m730:CedolareSecca m730:ContribSolidarieta</p>
<p>source</p>	<p><code><xs:element name="RitenuteAccontiSospesi" type="m730:Ritenute_Acconti_Sospesi_Type" minOccurs="0"/></code></p>

element **Primo_Modulo_Acconti_Ritenute_Type/MisuraAcconti**

<p>diagram</p>	
<p>namespace</p>	<p>urn:www.agenziaentrate.gov.it:specificheTecniche:sco:730</p>
<p>type</p>	<p>m730:Misura_Acconti_Type</p>
<p>children</p>	<p>m730:IrpefMisuralInferiore m730:AddComunaleMisuralInferiore m730:CedolareSeccaMisuralInferiore m730:NumeroRate</p>
<p>source</p>	<p><code><xs:element name="MisuraAcconti" type="m730:Misura_Acconti_Type" minOccurs="0"/></code></p>

element **Primo_Modulo_Acconti_Ritenute_Type/EsenzioneAddComunale**

diagram	
namespace	urn:www.agenziaentrate.gov.it:specificheTecniche:sco:730
type	m730:Esenzione_Add_Comunale_Type
children	m730:SogliaEsenzioneSaldo m730:SogliaEsenzioneAcconto
source	<code><xs:element name="EsenzioneAddComunale" type="m730:Esenzione_Add_Comunale_Type" minOccurs="0"/></code>

element **Primo_Modulo_Acconti_Ritenute_Type/Dati730Integrativo**

diagram	
namespace	urn:www.agenziaentrate.gov.it:specificheTecniche:sco:730
type	m730:Dati_730Integrativo_Type
children	m730:Rimborso m730:Credito
source	<code><xs:element name="Dati730Integrativo" type="m730:Dati_730Integrativo_Type" minOccurs="0"/></code>

element **Primo_Modulo_Acconti_Ritenute_Type/AccontiAltriDati**

diagram	
namespace	urn:www.agenziaentrate.gov.it:specificheTecniche:sco:730
type	m730:Acconti_Altri_Dati_Type
children	m730:IncapientiDetrazioneFigli m730:IncapientiDetrazioneLocazione m730:RestituzioneBonusFiscale m730:RestituzioneBonusStraordinario m730:Pignoramento
source	<code><xs:element name="AccontiAltriDati" type="m730:Acconti_Altri_Dati_Type" minOccurs="0"/></code>

complexType **Primo_Modulo_Crediti_Imposta_Type**

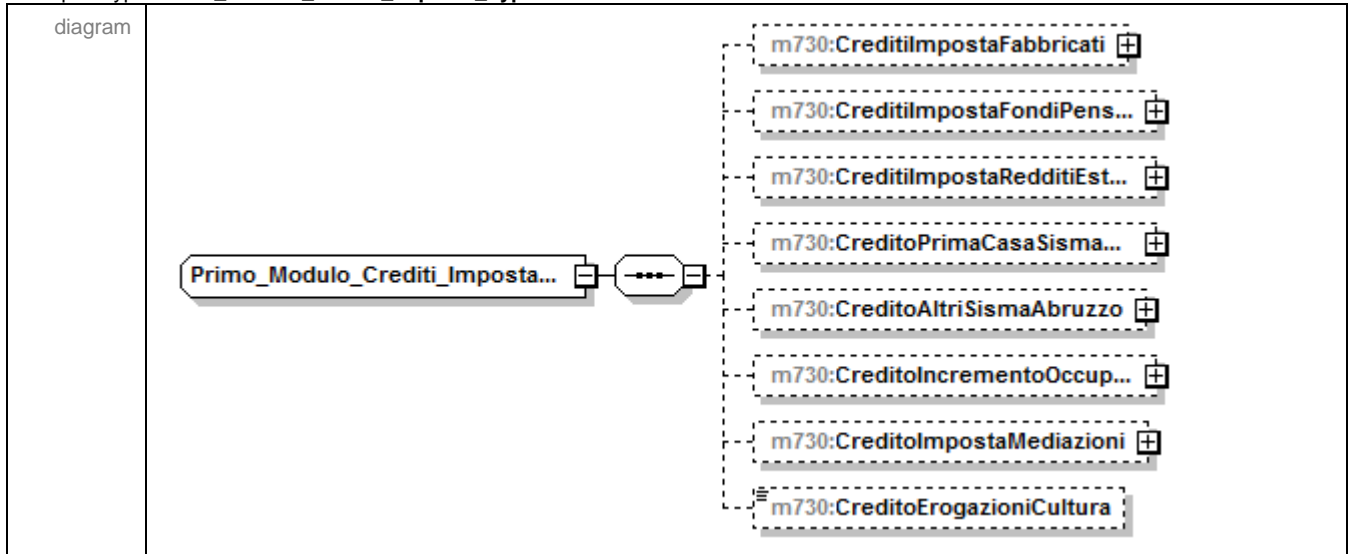

namespace urn:www.agenziaentrate.gov.it:specificheTecniche:sco:730

children [m730:CreditoImpostaFabbricati](#) [m730:CreditoImpostaFondiPensione](#) [m730:CreditoImpostaRedditiEsteri](#) [m730:CreditoPrimaCasaSismaAbruzzo](#) [m730:CreditoAltriSismaAbruzzo](#) [m730:CreditoIncrementoOccupazione](#) [m730:CreditoImpostaMediazioni](#) [m730:CreditoErogazioniCultura](#)

```
<xs:complexType name="Primo_Modulo_Crediti_Imposta_Type">
  <xs:sequence>
    <xs:element name="CreditoImpostaFabbricati" type="m730:Crediti_Imposta_Fabbricati_Type" minOccurs="0"/>
    <xs:element name="CreditoImpostaFondiPensione" minOccurs="0">
      <xs:complexType>
        <xs:complexContent>
          <xs:extension base="m730:Crediti_Imposta_Fondi_Pensione_Type">
            <xs:sequence>
              <xs:element name="ResiduoPrecedenteDichiarazione" type="cm:DatoNP_Type" minOccurs="0"/>
              <xs:element name="DiCuiCompensatoF24" type="cm:DatoNP_Type" minOccurs="0"/>
            </xs:sequence>
          </xs:extension>
        </xs:complexContent>
      </xs:complexType>
    </xs:element>
    <xs:element name="CreditoImpostaRedditiEsteri" type="m730:Crediti_Imposta_Redditi_Esteri_Type" minOccurs="0"/>
    <xs:element name="CreditoPrimaCasaSismaAbruzzo" minOccurs="0">
      <xs:complexType>
        <xs:complexContent>
          <xs:extension base="m730:Credito_Immobile_Sisma_Abruzzo_Type">
            <xs:sequence>
              <xs:element name="ResiduoPrecedenteDichiarazione" type="cm:DatoNP_Type" minOccurs="0"/>
            </xs:sequence>
          </xs:extension>
        </xs:complexContent>
      </xs:complexType>
    </xs:element>
    <xs:element name="CreditoAltriSismaAbruzzo" type="m730:Crediti_Imposta_Altri_Sisma_Abruzzo_Type"
      minOccurs="0"/>
    <xs:element name="CreditoIncrementoOccupazione" minOccurs="0">
      <xs:complexType>
        <xs:sequence>
          <xs:element name="ResiduoPrecedenteDichiarazione" type="cm:DatoNP_Type" minOccurs="0"/>
          <xs:element name="DiCuiCompensatoF24" type="cm:DatoNP_Type" minOccurs="0"/>
        </xs:sequence>
      </xs:complexType>
    </xs:element>
    <xs:element name="CreditoImpostaMediazioni" type="m730:Residuo_Credito_Compens_Annolmposta_Type"
      minOccurs="0"/>
  </xs:sequence>
</xs:complexType>
```

	<pre><xs:element name="CreditoErogazioniCultura" type="cm:DatoNP_Type" minOccurs="0"/> </xs:sequence> </xs:complexType></pre>
--	---

element **Primo_Modulo_Crediti_Imposta_Type/CreditiImpostaFabbricati**

diagram	
namespace	urn:www.agenziaentrate.gov.it:specificheTecniche:sco:730
type	m730:Crediti_Imposta_Fabbricati_Type
children	m730:ResiduoFabbricati m730:CanoniLocazioneNonPercepiti
source	<pre><xs:element name="CreditiImpostaFabbricati" type="m730:Crediti_Imposta_Fabbricati_Type" minOccurs="0"/></pre>

element **Primo_Modulo_Crediti_Imposta_Type/CreditiImpostaFondiPensione**

diagram	
namespace	urn:www.agenziaentrate.gov.it:specificheTecniche:sco:730
type	extension of m730:Crediti_Imposta_Fondi_Pensione_Type
children	m730:AnnoAnticipazione m730:Reintegro m730:SommaReintegrata m730:CreditoAnno m730:ResiduoPrecedenteDichiarazione m730:DiCuiCompensatoF24
source	<pre><xs:element name="CreditiImpostaFondiPensione" minOccurs="0"> <xs:complexType> <xs:complexContent> <xs:extension base="m730:Crediti_Imposta_Fondi_Pensione_Type"> <xs:sequence> <xs:element name="ResiduoPrecedenteDichiarazione" type="cm:DatoNP_Type" minOccurs="0"/> <xs:element name="DiCuiCompensatoF24" type="cm:DatoNP_Type" minOccurs="0"/> </xs:sequence> </xs:extension> </xs:complexContent> </xs:complexType> </xs:element></pre>

element **Primo_Modulo_Crediti_Imposta_Type/CreditiImpostaFondiPensione/ResiduoPrecedenteDichiarazione**

diagram	
namespace	urn:www.agenziaentrate.gov.it:specificheTecniche:sco:730
type	DatoNP_Type
facets	Kind Value pattern [1-9]{1}[0-9]*
source	<xs:element name="ResiduoPrecedenteDichiarazione" type="cm:DatoNP_Type" minOccurs="0"/>

element **Primo_Modulo_Crediti_Imposta_Type/CreditiImpostaFondiPensione/DiCuiCompensatoF24**

diagram	
namespace	urn:www.agenziaentrate.gov.it:specificheTecniche:sco:730
type	DatoNP_Type
facets	Kind Value pattern [1-9]{1}[0-9]*
source	<xs:element name="DiCuiCompensatoF24" type="cm:DatoNP_Type" minOccurs="0"/>

element **Primo_Modulo_Crediti_Imposta_Type/CreditiImpostaRedditiEsteri**

diagram	
namespace	urn:www.agenziaentrate.gov.it:specificheTecniche:sco:730
type	m730:Crediti_Imposta_Redditi_Esteri_Type
children	m730:StatoEestero m730:Anno m730:RedditoEestero m730:ImpostaEstera m730:RedditoComplessivo m730:Imposta_Lorda m730:ImpostaNetta m730:CreditoDichiarazioniPrecedenti m730:DiCuiStatoEestero
source	<xs:element name="CreditiImpostaRedditiEsteri" type="m730:Crediti_Imposta_Redditi_Esteri_Type" minOccurs="0"/>

element **Primo_Modulo_Crediti_Imposta_Type/CreditoPrimaCasaSismaAbruzzo**

diagram	
namespace	urn:www.agenziaentrate.gov.it:specificheTecniche:sco:730
type	extension of m730:Credito_Immobil_Sisma_Abruzzo_Type
children	m730:CodiceFiscale m730:NumeroRata m730:TotaleCredito m730:ResiduoPrecedenteDichiarazione
source	<pre><xs:element name="CreditoPrimaCasaSismaAbruzzo" minOccurs="0"> <xs:complexType> <xs:complexContent> <xs:extension base="m730:Credito_Immobil_Sisma_Abruzzo_Type"> <xs:sequence> <xs:element name="ResiduoPrecedenteDichiarazione" type="cm:DatoNP_Type" minOccurs="0"/> </xs:sequence> </xs:extension> </xs:complexContent> </xs:complexType> </xs:element></pre>

element **Primo_Modulo_Crediti_Imposta_Type/CreditoPrimaCasaSismaAbruzzo/ResiduoPrecedenteDichiarazione**

diagram					
namespace	urn:www.agenziaentrate.gov.it:specificheTecniche:sco:730				
type	DatoNP_Type				
facets	<table border="1"> <thead> <tr> <th>Kind</th> <th>Value</th> </tr> </thead> <tbody> <tr> <td>pattern</td> <td>[1-9]{1}[0-9]*</td> </tr> </tbody> </table>	Kind	Value	pattern	[1-9]{1}[0-9]*
Kind	Value				
pattern	[1-9]{1}[0-9]*				
source	<pre><xs:element name="ResiduoPrecedenteDichiarazione" type="cm:DatoNP_Type" minOccurs="0"/></pre>				

element **Primo_Modulo_Crediti_Imposta_Type/CreditoAltriSismaAbruzzo**

diagram	
namespace	urn:www.agenziaentrate.gov.it:specificheTecniche:sco:730
type	m730:Crediti_Imposta_Altri_Sisma_Abruzzo_Type
children	m730:Impresa_Professione m730:CreditoImmobil_SismaA... m730:Rateazione

source	<xs:element name="CreditoAltriSismaAbruzzo" type="m730:Crediti_Imposta_Altri_Sisma_Abruzzo_Type" minOccurs="0"/>
--------	--

element **Primo_Modulo_Crediti_Imposta_Type/CreditoIncrementoOccupazione**

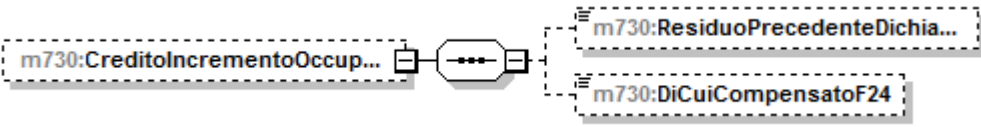
diagram	
namespace	urn:www.agenziaentrate.gov.it:specificheTecniche:sco:730
children	m730:ResiduoPrecedenteDichiarazione m730:DiCuiCompensatoF24
source	<xs:element name="CreditoIncrementoOccupazione" minOccurs="0"> <xs:complexType> <xs:sequence> <xs:element name="ResiduoPrecedenteDichiarazione" type="cm:DatoNP_Type" minOccurs="0"/> <xs:element name="DiCuiCompensatoF24" type="cm:DatoNP_Type" minOccurs="0"/> </xs:sequence> </xs:complexType> </xs:element>

element **Primo_Modulo_Crediti_Imposta_Type/CreditoIncrementoOccupazione/ResiduoPrecedenteDichiarazione**

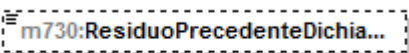
diagram	
namespace	urn:www.agenziaentrate.gov.it:specificheTecniche:sco:730
type	DatoNP_Type
facets	Kind Value pattern [1-9]{1}[0-9]*
source	<xs:element name="ResiduoPrecedenteDichiarazione" type="cm:DatoNP_Type" minOccurs="0"/>

element **Primo_Modulo_Crediti_Imposta_Type/CreditoIncrementoOccupazione/DiCuiCompensatoF24**

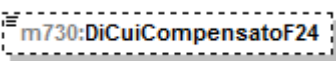
diagram	
namespace	urn:www.agenziaentrate.gov.it:specificheTecniche:sco:730
type	DatoNP_Type
facets	Kind Value pattern [1-9]{1}[0-9]*
source	<xs:element name="DiCuiCompensatoF24" type="cm:DatoNP_Type" minOccurs="0"/>

element **Primo_Modulo_Crediti_Imposta_Type/CreditoImpostaMediazioni**

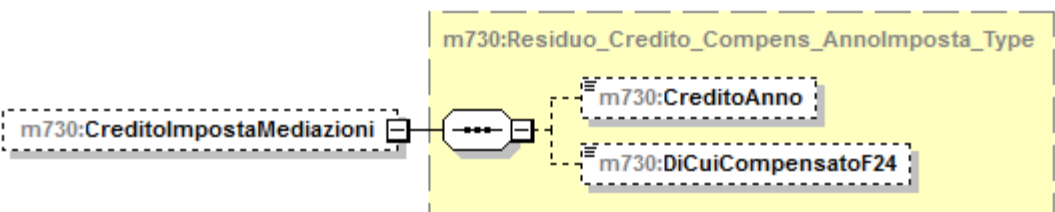
diagram	
namespace	urn:www.agenziaentrate.gov.it:specificheTecniche:sco:730
type	m730:Residuo_Credito_Compens_AnnolImposta_Type

children	m730:CreditoAnno m730:DiCuiCompensatoF24
source	<code><xs:element name="CreditoImpostaMediazioni" type="m730:Residuo_Credito_Compens_Annolmposta_Type" minOccurs="0"/></code>

element **Primo_Modulo_Crediti_Imposta_Type/CreditoErogazioniCultura**

diagram	
namespace	urn:www.agenziaentrate.gov.it:specificheTecniche:sco:730
type	DatoNP_Type
facets	Kind Value pattern [1-9]{1}[0-9]*
source	<code><xs:element name="CreditoErogazioniCultura" type="cm:DatoNP_Type" minOccurs="0"/></code>

complexType **Primo_Modulo_Lavoro_Dip_Type**

diagram	
namespace	urn:www.agenziaentrate.gov.it:specificheTecniche:sco:730
children	m730:LavoroDipendente m730:IncrementoProduttivita m730:PeriodoLavoro m730:AltriRedditiAssLavDip m730:RitenuteLavoroDipendente m730:BonusIrpef m730:RedditoAlNettoContribPensi... m730:ContribSolidarietaTrattenu... m730:CasellaCasiParticolari
source	<pre><xs:complexType name="Primo_Modulo_Lavoro_Dip_Type"> <xs:sequence> <xs:element name="LavoroDipendente" type="m730:Lavoro_Dipendente_Type" minOccurs="0" maxOccurs="3"/> <xs:element name="IncrementoProduttivita" type="m730:Incremento_Produttivita_Type" minOccurs="0"/> <xs:element name="PeriodoLavoro" type="m730:Periodo_Di_Lavoro_Type" minOccurs="0"/> <xs:element name="AltriRedditiAssLavDip" type="m730:Altri_Redditi_Ass_Lavd_Type" minOccurs="0" maxOccurs="3"/> <xs:element name="RitenuteLavoroDipendente" type="m730:Ritenute_Lavoro_Dip_Type" minOccurs="0"/> <xs:element name="BonusIrpef" type="m730:Bonus_Irpef_Type" minOccurs="0"/> <xs:element name="RedditoAlNettoContribPensi..." type="cm:DatoNP_Type" minOccurs="0"/> <xs:element name="ContribSolidarietaTrattenu..." type="cm:DatoNP_Type" minOccurs="0"/> <xs:element name="CasellaCasiParticolari" minOccurs="0"/> </xs:sequence> <xs:simpleType> <xs:restriction base="cm:DatoN1_Type"></pre>

```

<xs:enumeration value="1"/>
<xs:enumeration value="2"/>
<xs:enumeration value="3"/>
</xs:restriction>
</xs:simpleType>
</xs:element>
</xs:sequence>
</xs:complexType>

```

element **Primo_Modulo_Lavoro_Dip_Type/LavoroDipendente**

diagram	
namespace	urn:www.agenziaentrte.gov.it:specificheTecniche:sco:730
type	m730:Lavoro_Dipendente_Type
children	m730:TipologiaReddito m730:TipoContratto m730:Reddito
source	<code><xs:element name="LavoroDipendente" type="m730:Lavoro_Dipendente_Type" minOccurs="0" maxOccurs="3"/></code>

element **Primo_Modulo_Lavoro_Dip_Type/IncrementoProduttivita**

diagram	
namespace	urn:www.agenziaentrte.gov.it:specificheTecniche:sco:730
type	m730:Incremento_Produttivita_Type
children	m730:ImportoTassazOrdinaria m730:ImportoImpostaSostitutiva m730:RitenuteImpostaSostitutiva m730:Art51Ordinaria m730:Art51Sostitutiva m730:TassazOrdinaria m730:TassazSostitutiva
source	<code><xs:element name="IncrementoProduttivita" type="m730:Incremento_Produttivita_Type" minOccurs="0"/></code>

element **Primo_Modulo_Lavoro_Dip_Type/PeriodoLavoro**

diagram	
namespace	urn:www.agenziaentrate.gov.it:specificheTecniche:sco:730
type	m730:Periodo_Di_Lavoro_Type
children	m730:GiorniLavoroDipendente m730:GiorniPensione
source	<code><xs:element name="PeriodoLavoro" type="m730:Periodo_Di_Lavoro_Type" minOccurs="0"/></code>

element **Primo_Modulo_Lavoro_Dip_Type/AltriRedditiAssLavDip**

diagram	
namespace	urn:www.agenziaentrate.gov.it:specificheTecniche:sco:730
type	m730:Altri_Redditi_Ass_Lavd_Type
children	m730:AssegnoDelConiuge m730:ImportoRedditoAssimilato
source	<code><xs:element name="AltriRedditiAssLavDip" type="m730:Altri_Redditi_Ass_Lavd_Type" minOccurs="0" maxOccurs="3"/></code>

element **Primo_Modulo_Lavoro_Dip_Type/RitenuteLavoroDipendente**

diagram	
namespace	urn:www.agenziaentrate.gov.it:specificheTecniche:sco:730
type	m730:Ritenute_Lavoro_Dip_Type
children	m730:Ritlrpef m730:RitAddRegionale m730:RitAccAddComunale m730:RitSaldoAddComunale m730:RitAccAddComAnnoPres
source	<code><xs:element name="RitenuteLavoroDipendente" type="m730:Ritenute_Lavoro_Dip_Type" minOccurs="0"/></code>

element **Primo_Modulo_Lavoro_Dip_Type/BonusIrpef**

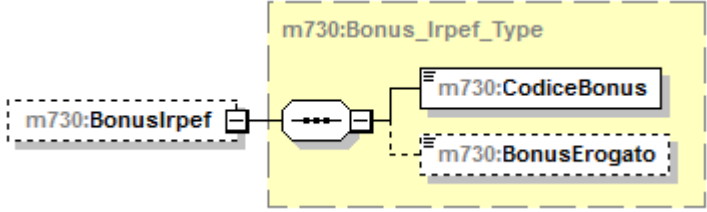
diagram	
namespace	urn:www.agenziaentrate.gov.it:specificheTecniche:sco:730
type	m730:Bonus_Irpef_Type
children	m730:CodiceBonus m730:BonusErogato
source	<code><xs:element name="BonusIrpef" type="m730:Bonus_Irpef_Type" minOccurs="0"/></code>

element **Primo_Modulo_Lavoro_Dip_Type/RedditoAlNettoContribPensioni**

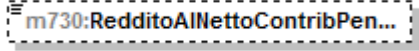
diagram					
namespace	urn:www.agenziaentrate.gov.it:specificheTecniche:sco:730				
type	DatoNP_Type				
facets	<table border="1"> <thead> <tr> <th>Kind</th> <th>Value</th> </tr> </thead> <tbody> <tr> <td>pattern</td> <td>[1-9]{1}[0-9]*</td> </tr> </tbody> </table>	Kind	Value	pattern	[1-9]{1}[0-9]*
Kind	Value				
pattern	[1-9]{1}[0-9]*				
source	<code><xs:element name="RedditoAlNettoContribPensioni" type="cm:DatoNP_Type" minOccurs="0"/></code>				

element **Primo_Modulo_Lavoro_Dip_Type/ContribSolidarietaTrattenuto**

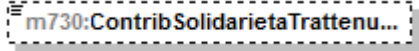
diagram					
namespace	urn:www.agenziaentrate.gov.it:specificheTecniche:sco:730				
type	DatoNP_Type				
facets	<table border="1"> <thead> <tr> <th>Kind</th> <th>Value</th> </tr> </thead> <tbody> <tr> <td>pattern</td> <td>[1-9]{1}[0-9]*</td> </tr> </tbody> </table>	Kind	Value	pattern	[1-9]{1}[0-9]*
Kind	Value				
pattern	[1-9]{1}[0-9]*				
source	<code><xs:element name="ContribSolidarietaTrattenuto" type="cm:DatoNP_Type" minOccurs="0"/></code>				

element **Primo_Modulo_Lavoro_Dip_Type/CasellaCasiParticolari**

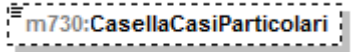
diagram											
namespace	urn:www.agenziaentrate.gov.it:specificheTecniche:sco:730										
type	restriction of DatoN1_Type										
facets	<table border="1"> <thead> <tr> <th>Kind</th> <th>Value</th> </tr> </thead> <tbody> <tr> <td>pattern</td> <td>[1-9]</td> </tr> <tr> <td>enumeration</td> <td>1</td> </tr> <tr> <td>enumeration</td> <td>2</td> </tr> <tr> <td>enumeration</td> <td>3</td> </tr> </tbody> </table>	Kind	Value	pattern	[1-9]	enumeration	1	enumeration	2	enumeration	3
Kind	Value										
pattern	[1-9]										
enumeration	1										
enumeration	2										
enumeration	3										
source	<code><xs:element name="CasellaCasiParticolari" minOccurs="0"> <xs:simpleType> <xs:restriction base="cm:DatoN1_Type"> <xs:enumeration value="1"/> <xs:enumeration value="2"/></code>										

	<pre> <xs:enumeration value="3"/> </xs:restriction> </xs:simpleType> </xs:element> </pre>
--	---

complexType **Primo_Modulo_PL_Type**

diagram	
namespace	urn:www.agenziaentrate.gov.it:specificheTecniche:sco:730
children	m730:Prospetto m730:ProspettoRideterminato
source	<pre> <xs:complexType name="Primo_Modulo_PL_Type"> <xs:sequence> <xs:element name="Prospetto"> <xs:complexType> <xs:complexContent> <xs:extension base="m730:Prospetto_Type"> <xs:sequence> <xs:element name="Addizionali" type="m730:Addizionali_Type" minOccurs="0"/> <xs:element name="CedolareSecca" type="m730:Cedolare_Secca_Type" minOccurs="0"/> <xs:element name="ContributoSolidarieta" type="m730:Contributo_Solidarieta_Type" minOccurs="0"/> <xs:element name="LiquidazioneImposte" minOccurs="0"> <xs:complexType> <xs:sequence> <xs:element name="Esitolrpef" type="m730:Esito_Liquidazione_Type" minOccurs="0"/> <xs:element name="EsitoAddRegionale" minOccurs="0"> <xs:complexType> <xs:complexContent> <xs:extension base="m730:Esito_Liquidazione_Type"> <xs:sequence> <xs:element name="CodAddReg" type="sc:Codice_Regione_Type"/> </xs:sequence> </xs:extension> </xs:complexContent> </xs:complexType> </xs:element> <xs:element name="EsitoAddComunale" minOccurs="0"> <xs:complexType> <xs:complexContent> <xs:extension base="m730:Esito_Liquidazione_Type"> <xs:sequence> <xs:element name="CodiceAddCom" type="cm:DatoAN_Type"/> </xs:sequence> </xs:extension> </xs:complexContent> </xs:complexType> </xs:element> <xs:element name="PrimaRataAcclrpef" type="cm:DatoNP_Type" minOccurs="0"/> <xs:element name="SecondaRataAcclrpef" type="cm:DatoNP_Type" minOccurs="0"/> <xs:element name="AccontoTassSep" type="m730:Debito_Type" minOccurs="0"/> <xs:element name="AccontoAddComunale" minOccurs="0"> <xs:complexType> <xs:sequence> <xs:element name="CodiceAddComAcconto" type="cm:DatoAN_Type"/> <xs:element name="AccontoAddCom" type="cm:DatoNP_Type"/> </xs:sequence> </xs:complexType> </xs:element> <xs:element name="ImpSostProdut" type="m730:Debito_Type" minOccurs="0"/> <xs:element name="EsitoCedolareSecca" type="m730:Esito_Liquidazione_Type" minOccurs="0"/> <xs:element name="PrimaRataAccCedolare" type="cm:DatoNP_Type" minOccurs="0"/> <xs:element name="SecondaRataAccCedolare" type="cm:DatoNP_Type" minOccurs="0"/> <xs:element name="ContribSolidarietaDebito" type="m730:Debito_Type" minOccurs="0"/> </pre>

```

</xs:sequence>
</xs:complexType>
</xs:element>
<xs:element name="AltriDati" type="m730:Altri_Dati_Type" minOccurs="0"/>
<xs:element name="CredImpEstero" type="m730:Cred_Imp_Estero_Type" minOccurs="0"/>
<xs:element name="DatiCreditiF24" type="m730:Crediti_F24_Type" minOccurs="0"/>
</xs:sequence>
</xs:extension>
</xs:complexContent>
</xs:complexType>
</xs:element>
<xs:element name="ProspettoRideterminato" minOccurs="0">
<xs:complexType>
<xs:complexContent>
<xs:extension base="m730:Prospetto_Type">
<xs:sequence>
<xs:element name="RedditoAgevolazioniFiscali" type="cm:DatoNP_Type" minOccurs="0"/>
</xs:sequence>
</xs:extension>
</xs:complexContent>
</xs:complexType>
</xs:element>
</xs:sequence>
</xs:complexType>

```

element **Primo_Modulo_PL_Type/Prospetto**

diagram

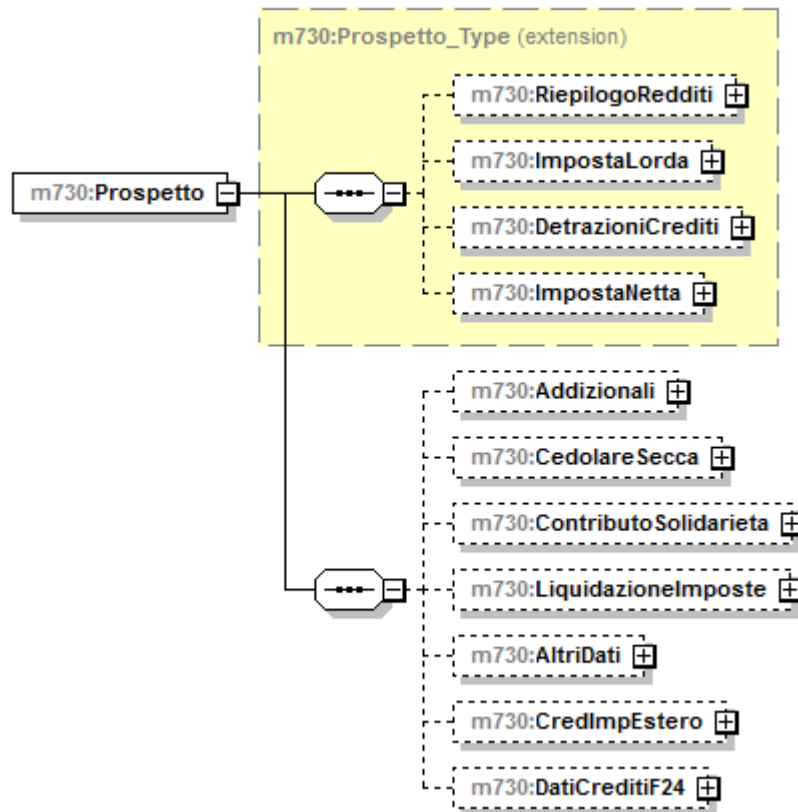

namespace urn:www.agenziaentrate.gov.it:specificheTecniche:sco:730

type extension of [m730:Prospetto_Type](#)

children [m730:RiepilogoRedditi](#) [m730:ImpostaLorda](#) [m730:DetrazioniCrediti](#) [m730:ImpostaNetta](#) [m730:Addizionali](#) [m730:CedolareSecca](#) [m730:ContributoSolidarieta](#) [m730:LiquidazioneImposte](#) [m730:AltriDati](#) [m730:CredImpEstero](#) [m730:DatiCreditiF24](#)

source

```
<xs:element name="Prospetto">
  <xs:complexType>
    <xs:complexContent>
      <xs:extension base="m730:Prospetto_Type">
        <xs:sequence>
          <xs:element name="Addizionali" type="m730:Addizionali_Type" minOccurs="0"/>
          <xs:element name="CedolareSecca" type="m730:Cedolare_Secca_Type" minOccurs="0"/>
          <xs:element name="ContributoSolidarieta" type="m730:Contributo_Solidarieta_Type" minOccurs="0"/>
          <xs:element name="LiquidazioneImposte" minOccurs="0">
            <xs:complexType>
              <xs:sequence>
                <xs:element name="EsitoIrpef" type="m730:Esito_Liquidazione_Type" minOccurs="0"/>
                <xs:element name="EsitoAddRegionale" minOccurs="0">
                  <xs:complexType>
                    <xs:complexContent>
                      <xs:extension base="m730:Esito_Liquidazione_Type">
                        <xs:sequence>
                          <xs:element name="CodAddReg" type="sc:Codice_Regione_Type"/>
                        </xs:sequence>
                      </xs:extension>
                    </xs:complexContent>
                  </xs:complexType>
                </xs:element>
                <xs:element name="EsitoAddComunale" minOccurs="0">
                  <xs:complexType>
                    <xs:complexContent>
                      <xs:extension base="m730:Esito_Liquidazione_Type">
                        <xs:sequence>
                          <xs:element name="CodiceAddCom" type="cm:DatoAN_Type"/>
                        </xs:sequence>
                      </xs:extension>
                    </xs:complexContent>
                  </xs:complexType>
                </xs:element>
                <xs:element name="PrimaRataAcclIrpef" type="cm:DatoNP_Type" minOccurs="0"/>
                <xs:element name="SecondaRataAcclIrpef" type="cm:DatoNP_Type" minOccurs="0"/>
                <xs:element name="AccontoTassSep" type="m730:Debito_Type" minOccurs="0"/>
                <xs:element name="AccontoAddComunale" minOccurs="0">
                  <xs:complexType>
                    <xs:sequence>
                      <xs:element name="CodiceAddComAcconto" type="cm:DatoAN_Type"/>
                      <xs:element name="AccontoAddCom" type="cm:DatoNP_Type"/>
                    </xs:sequence>
                  </xs:complexType>
                </xs:element>
                <xs:element name="ImpSostProdut" type="m730:Debito_Type" minOccurs="0"/>
                <xs:element name="EsitoCedolareSecca" type="m730:Esito_Liquidazione_Type" minOccurs="0"/>
                <xs:element name="PrimaRataAccCedolare" type="cm:DatoNP_Type" minOccurs="0"/>
                <xs:element name="SecondaRataAccCedolare" type="cm:DatoNP_Type" minOccurs="0"/>
                <xs:element name="ContribSolidarietaDebito" type="m730:Debito_Type" minOccurs="0"/>
              </xs:sequence>
            </xs:complexType>
          </xs:element>
          <xs:element name="AltriDati" type="m730:Altri_Dati_Type" minOccurs="0"/>
          <xs:element name="CredImpEstero" type="m730:Cred_Imp_Estero_Type" minOccurs="0"/>
          <xs:element name="DatiCreditiF24" type="m730:Crediti_F24_Type" minOccurs="0"/>
        </xs:sequence>
      </xs:extension>
    </xs:complexContent>
  </xs:complexType>
</xs:element>
```

element **Primo_Modulo_PL_Type/Prospetto/Addizionali**

<p>diagram</p>	
<p>namespace</p>	<p>urn:www.agenziaentrate.gov.it:specificheTecniche:sco:730</p>
<p>type</p>	<p>m730:Addizionali_Type</p>
<p>children</p>	<p>m730:Imponibile m730:AddRegDovuta m730:AddRegCertif m730:EccedenzaAddReg m730:AddComDovuta m730:AddComCertif m730:EccedenzaAddCom m730:AccontoAddCom m730:AccontoAddComCertif</p>
<p>source</p>	<p><code><xs:element name="Addizionali" type="m730:Addizionali_Type" minOccurs="0"/></code></p>

element **Primo_Modulo_PL_Type/Prospetto/CedolareSecca**

<p>diagram</p>	
<p>namespace</p>	<p>urn:www.agenziaentrate.gov.it:specificheTecniche:sco:730</p>
<p>type</p>	<p>m730:Cedolare Secca Type</p>
<p>children</p>	<p>m730:CedolareDovuta m730:EccedenzaCedolareSecca m730:AccontoCedolare</p>
<p>source</p>	<p><code><xs:element name="CedolareSecca" type="m730:Cedolare_Secca_Type" minOccurs="0"/></code></p>

element **Primo_Modulo_PL_Type/Prospetto/ContributoSolidarieta**

diagram	
namespace	urn:www.agenziaentrate.gov.it:specificheTecniche:sco:730
type	m730:Contributo_Solidarieta_Type
children	m730:ImponibileContributo m730:ContributoDovuto m730:ContributoCertificaz
source	<code><xs:element name="ContributoSolidarieta" type="m730:Contributo_Solidarieta_Type" minOccurs="0"/></code>

element **Primo_Modulo_PL_Type/Prospetto/LiquidazioneImposte**

diagram	
namespace	urn:www.agenziaentrate.gov.it:specificheTecniche:sco:730
children	m730:EsitoLrpef m730:EsitoAddRegionale m730:EsitoAddComunale m730:PrimaRataAcclrpef m730:SecondaRataAcclrpef m730:AccontoTassSep m730:AccontoAddComunale m730:ImpSostProduit m730:EsitoCedolareSecca m730:PrimaRataAccCedolare m730:SecondaRataAccCedolare m730:ContribSolidarietaDebito
source	<pre> <xs:element name="LiquidazioneImposte" minOccurs="0"> <xs:complexType> <xs:sequence> <xs:element name="EsitoLrpef" type="m730:Esito_Liquidazione_Type" minOccurs="0"/> <xs:element name="EsitoAddRegionale" minOccurs="0"> </pre>

```

<xs:complexType>
  <xs:complexContent>
    <xs:extension base="m730:Esito_Liquidazione_Type">
      <xs:sequence>
        <xs:element name="CodAddReg" type="sc:Codice_Regione_Type"/>
      </xs:sequence>
    </xs:extension>
  </xs:complexContent>
</xs:complexType>
</xs:element>
<xs:element name="EsitoAddComunale" minOccurs="0">
  <xs:complexType>
    <xs:complexContent>
      <xs:extension base="m730:Esito_Liquidazione_Type">
        <xs:sequence>
          <xs:element name="CodiceAddCom" type="cm:DatoAN_Type"/>
        </xs:sequence>
      </xs:extension>
    </xs:complexContent>
  </xs:complexType>
</xs:element>
<xs:element name="PrimaRataAcclrpef" type="cm:DatoNP_Type" minOccurs="0"/>
<xs:element name="SecondaRataAcclrpef" type="cm:DatoNP_Type" minOccurs="0"/>
<xs:element name="AccontoTassSep" type="m730:Debito_Type" minOccurs="0"/>
<xs:element name="AccontoAddComunale" minOccurs="0">
  <xs:complexType>
    <xs:sequence>
      <xs:element name="CodiceAddComAcconto" type="cm:DatoAN_Type"/>
      <xs:element name="AccontoAddCom" type="cm:DatoNP_Type"/>
    </xs:sequence>
  </xs:complexType>
</xs:element>
<xs:element name="ImpSostProduit" type="m730:Debito_Type" minOccurs="0"/>
<xs:element name="EsitoCedolareSecca" type="m730:Esito_Liquidazione_Type" minOccurs="0"/>
<xs:element name="PrimaRataAccCedolare" type="cm:DatoNP_Type" minOccurs="0"/>
<xs:element name="SecondaRataAccCedolare" type="cm:DatoNP_Type" minOccurs="0"/>
<xs:element name="ContribSolidarietaDebito" type="m730:Debito_Type" minOccurs="0"/>
</xs:sequence>
</xs:complexType>
</xs:element>

```

element **Primo_Modulo_PL_Type/Prospetto/LiquidazioneImposte/EsitoIrpef**

diagram	<pre> classDiagram class m730EsitoIrpef { } class m730EsitoLiquidazione_Type { } class m730Credito { } class m730Debito { } m730EsitoIrpef .. > m730EsitoLiquidazione_Type m730EsitoLiquidazione_Type -- m730Credito m730EsitoLiquidazione_Type -- m730Debito </pre>
namespace	urn:www.agenziaentrate.gov.it:specificheTecniche:sco:730
type	m730:Esito Liquidazione Type
children	m730:Credito m730:Debito
source	<xs:element name="EsitoIrpef" type="m730:Esito_Liquidazione_Type" minOccurs="0"/>

element **Primo_Modulo_PL_Type/Prospetto/LiquidazioneImposte/EsitoAddRegionale**

diagram	
namespace	urn:www.agenziaentrate.gov.it:specificheTecniche:sco:730
type	extension of m730:Esito_Liquidazione_Type
children	m730:Credito m730:Debito m730:CodAddReg
source	<pre><xs:element name="EsitoAddRegionale" minOccurs="0"> <xs:complexType> <xs:complexContent> <xs:extension base="m730:Esito_Liquidazione_Type"> <xs:sequence> <xs:element name="CodAddReg" type="sc:Codice_Regione_Type"/> </xs:sequence> </xs:extension> </xs:complexContent> </xs:complexType> </xs:element></pre>

element **Primo_Modulo_PL_Type/Prospetto/LiquidazioneImposte/EsitoAddRegionale/CodAddReg**

diagram																																															
namespace	urn:www.agenziaentrate.gov.it:specificheTecniche:sco:730																																														
type	Codice_Regione_Type																																														
facets	<table border="1"> <thead> <tr> <th>Kind</th> <th>Value</th> </tr> </thead> <tbody> <tr> <td>pattern</td> <td>([0-9A-Z\-\-] &quot;){1}([0-9A-Z&amp;:] '\-\. , /° \\ (\) À È É Ì Ò Ù Û &quot; \\ / +)*</td> </tr> <tr><td>enumeration</td><td>1</td></tr> <tr><td>enumeration</td><td>2</td></tr> <tr><td>enumeration</td><td>3</td></tr> <tr><td>enumeration</td><td>4</td></tr> <tr><td>enumeration</td><td>5</td></tr> <tr><td>enumeration</td><td>6</td></tr> <tr><td>enumeration</td><td>7</td></tr> <tr><td>enumeration</td><td>8</td></tr> <tr><td>enumeration</td><td>9</td></tr> <tr><td>enumeration</td><td>10</td></tr> <tr><td>enumeration</td><td>11</td></tr> <tr><td>enumeration</td><td>12</td></tr> <tr><td>enumeration</td><td>13</td></tr> <tr><td>enumeration</td><td>14</td></tr> <tr><td>enumeration</td><td>15</td></tr> <tr><td>enumeration</td><td>16</td></tr> <tr><td>enumeration</td><td>17</td></tr> <tr><td>enumeration</td><td>18</td></tr> <tr><td>enumeration</td><td>19</td></tr> <tr><td>enumeration</td><td>20</td></tr> <tr><td>enumeration</td><td>21</td></tr> </tbody> </table>	Kind	Value	pattern	([0-9A-Z\-\-] "){1}([0-9A-Z&:] '\-\. , /° \\ (\) À È É Ì Ò Ù Û " \\ / +)*	enumeration	1	enumeration	2	enumeration	3	enumeration	4	enumeration	5	enumeration	6	enumeration	7	enumeration	8	enumeration	9	enumeration	10	enumeration	11	enumeration	12	enumeration	13	enumeration	14	enumeration	15	enumeration	16	enumeration	17	enumeration	18	enumeration	19	enumeration	20	enumeration	21
Kind	Value																																														
pattern	([0-9A-Z\-\-] "){1}([0-9A-Z&:] '\-\. , /° \\ (\) À È É Ì Ò Ù Û " \\ / +)*																																														
enumeration	1																																														
enumeration	2																																														
enumeration	3																																														
enumeration	4																																														
enumeration	5																																														
enumeration	6																																														
enumeration	7																																														
enumeration	8																																														
enumeration	9																																														
enumeration	10																																														
enumeration	11																																														
enumeration	12																																														
enumeration	13																																														
enumeration	14																																														
enumeration	15																																														
enumeration	16																																														
enumeration	17																																														
enumeration	18																																														
enumeration	19																																														
enumeration	20																																														
enumeration	21																																														
source	<pre><xs:element name="CodAddReg" type="sc:Codice_Regione_Type"/></pre>																																														

type	DatoNP_Type
facets	Kind Value pattern [1-9]{1}[0-9]*
source	<code><xs:element name="SecondaRataAcclrpef" type="cm:DatoNP_Type" minOccurs="0"/></code>

element **Primo_Modulo_PL_Type/Prospetto/LiquidazioneImposte/AccontoTassSep**

diagram	
namespace	urn:www.agenziaentrate.gov.it:specificheTecniche:sco:730
type	m730:Debito_Type
children	m730:NonVersare m730:ImportoDaTrattenere
source	<code><xs:element name="AccontoTassSep" type="m730:Debito_Type" minOccurs="0"/></code>

element **Primo_Modulo_PL_Type/Prospetto/LiquidazioneImposte/AccontoAddComunale**

diagram	
namespace	urn:www.agenziaentrate.gov.it:specificheTecniche:sco:730
children	m730:CodiceAddComAcconto m730:AccontoAddCom
source	<pre> <xs:element name="AccontoAddComunale" minOccurs="0"> <xs:complexType> <xs:sequence> <xs:element name="CodiceAddComAcconto" type="cm:DatoAN_Type"/> <xs:element name="AccontoAddCom" type="cm:DatoNP_Type"/> </xs:sequence> </xs:complexType> </xs:element> </pre>

element **Primo_Modulo_PL_Type/Prospetto/LiquidazioneImposte/AccontoAddComunale/CodiceAddComAcconto**

diagram	
namespace	urn:www.agenziaentrate.gov.it:specificheTecniche:sco:730
type	DatoAN_Type
facets	Kind Value pattern ([0-9A-Z-] \"){1}([0-9A-Z&:] [-\ ., / ° ^\(\ \)\ À È É Ì Ò Ú Û " \ \\ \ +)*
source	<code><xs:element name="CodiceAddComAcconto" type="cm:DatoAN_Type"/></code>

element **Primo_Modulo_PL_Type/Prospetto/LiquidazioneImposte/AccontoAddComunale/AccontoAddCom**

diagram	
---------	--

namespace	urn:www.agenziaentrate.gov.it:specificheTecniche:sco:730
type	DatoNP_Type
facets	Kind Value pattern [1-9]{1}[0-9]*
source	<xs:element name="AccontoAddCom" type="cm:DatoNP_Type"/>

element **Primo_Modulo_PL_Type/Prospetto/LiquidazioneImposte/ImpSostProdut**

diagram	
namespace	urn:www.agenziaentrate.gov.it:specificheTecniche:sco:730
type	m730:Debito_Type
children	m730:NonVersare m730:ImportoDaTrattenere
source	<xs:element name="ImpSostProdut" type="m730:Debito_Type" minOccurs="0"/>

element **Primo_Modulo_PL_Type/Prospetto/LiquidazioneImposte/EsitoCedolareSecca**

diagram	
namespace	urn:www.agenziaentrate.gov.it:specificheTecniche:sco:730
type	m730:Esito_Liquidazione_Type
children	m730:Credito m730:Debito
source	<xs:element name="EsitoCedolareSecca" type="m730:Esito_Liquidazione_Type" minOccurs="0"/>

element **Primo_Modulo_PL_Type/Prospetto/LiquidazioneImposte/PrimaRataAccCedolare**

diagram	
namespace	urn:www.agenziaentrate.gov.it:specificheTecniche:sco:730
type	DatoNP_Type
facets	Kind Value pattern [1-9]{1}[0-9]*
source	<xs:element name="PrimaRataAccCedolare" type="cm:DatoNP_Type" minOccurs="0"/>

element **Primo_Modulo_PL_Type/Prospetto/LiquidazioneImposte/SecondaRataAccCedolare**

diagram	
---------	--

namespace	urn:www.agenziaentrate.gov.it:specificheTecniche:sco:730
type	DatoNP_Type
facets	Kind Value pattern [1-9]{1}[0-9]*
source	<xs:element name="SecondaRataAccCedolare" type="cm:DatoNP_Type" minOccurs="0"/>

element **Primo_Modulo_PL_Type/Prospetto/LiquidazioneImposte/ContribSolidarietaDebito**

diagram	<pre> classDiagram class m730_ContribSolidarietaDebito class m730_Debito_Type { m730_NonVersare m730_ImportoDaTrattenere } m730_ContribSolidarietaDebito -- m730_Debito_Type </pre>
namespace	urn:www.agenziaentrate.gov.it:specificheTecniche:sco:730
type	m730:Debito_Type
children	m730:NonVersare m730:ImportoDaTrattenere
source	<xs:element name="ContribSolidarietaDebito" type="m730:Debito_Type" minOccurs="0"/>

element **Primo_Modulo_PL_Type/Prospetto/AltriDati**

<p>diagram</p>	
<p>namespace</p>	<p>urn:www.agenziaentrate.gov.it:specificheTecniche:sco:730</p>
<p>type</p>	<p>m730:Altri_Dati_Type</p>
<p>children</p>	<p>m730:ResiduoCreditoErogazioneCultura m730:ResiduoCreditoPrimaCasa m730:ResiduoCreditoOccupazione m730:ResiduoCreditoSisma m730:ResiduoCreditoFondiPensione m730:ResiduoCreditoMediazioni m730:TotSpeseSanitarieRateizzate m730:RedditoAgevolazioniFiscali m730:RedditoComplessivoAcconto m730:RigoDifferenzaAcconto m730:RedditiFondiariniNonImponibili m730:RedditoAbitazionePrincipalePertinenze m730:ResiduoDeduzioneSommeRestituite</p>
<p>source</p>	<p><xs:element name="AltriDati" type="m730:Altri_Dati_Type" minOccurs="0"/></p>

element **Primo_Modulo_PL_Type/Prospetto/CredImpEstero**

<p>diagram</p>	
----------------	--

namespace	urn:www.agenziaentrate.gov.it:specificheTecniche:sco:730
type	m730:Cred_Imp_Estero_Type
children	m730:Anno m730:TotCredito m730:CreditoStato
source	<xs:element name="CredImpEstero" type="m730:Cred_Imp_Estero_Type" minOccurs="0"/>

element **Primo_Modulo_PL_Type/Prospetto/DatiCreditiF24**

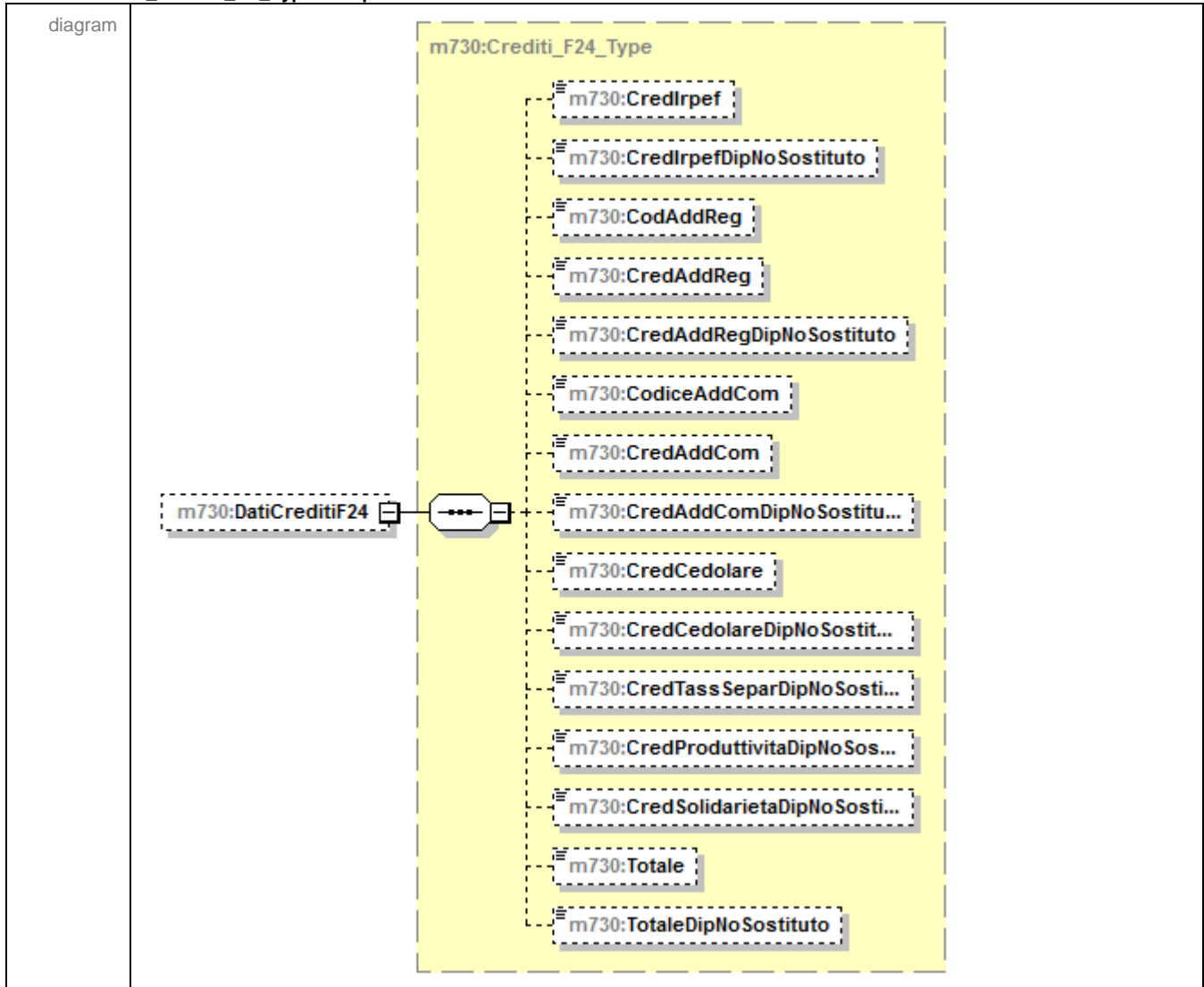

namespace	urn:www.agenziaentrate.gov.it:specificheTecniche:sco:730
type	m730:Crediti_F24_Type
children	m730:Credlrpef m730:CredlrpefDipNoSostituto m730:CodAddReg m730:CredAddReg m730:CredAddRegDipNoSostituto m730:CodiceAddCom m730:CredAddCom m730:CredAddComDipNoSostituto m730:CredCedolare m730:CredCedolareDipNoSostituto m730:CredTassSeparDipNoSostituto m730:CredProduttivitaDipNoSostituto m730:CredSolidarietaDipNoSostituto m730:Totale m730:TotaleDipNoSostituto
source	<xs:element name="DatiCreditiF24" type="m730:Crediti_F24_Type" minOccurs="0"/>

element **Primo_Modulo_PL_Type/ProspettoRideterminato**

diagram	
namespace	urn:www.agenziaentrate.gov.it:specificheTecniche:sco:730
type	extension of m730:Prospetto_Type
children	m730:RiepilogoRedditi m730:ImpostaLorda m730:DetrazioniCrediti m730:ImpostaNetta m730:RedditoAgevolazioniFiscali
source	<pre> <xs:element name="ProspettoRideterminato" minOccurs="0"> <xs:complexType> <xs:complexContent> <xs:extension base="m730:Prospetto_Type"> <xs:sequence> <xs:element name="RedditoAgevolazioniFiscali" type="cm:DatoNP_Type" minOccurs="0"/> </xs:sequence> </xs:extension> </xs:complexContent> </xs:complexType> </xs:element> </pre>

element **Primo_Modulo_PL_Type/ProspettoRideterminato/RedditoAgevolazioniFiscali**

diagram					
namespace	urn:www.agenziaentrate.gov.it:specificheTecniche:sco:730				
type	DatoNP_Type				
facets	<table border="1"> <thead> <tr> <th>Kind</th> <th>Value</th> </tr> </thead> <tbody> <tr> <td>pattern</td> <td>[1-9]{1}[0-9]*</td> </tr> </tbody> </table>	Kind	Value	pattern	[1-9]{1}[0-9]*
Kind	Value				
pattern	[1-9]{1}[0-9]*				
source	<pre> <xs:element name="RedditoAgevolazioniFiscali" type="cm:DatoNP_Type" minOccurs="0"/> </pre>				

complexType **PrimoModulo_Oneri_Type**

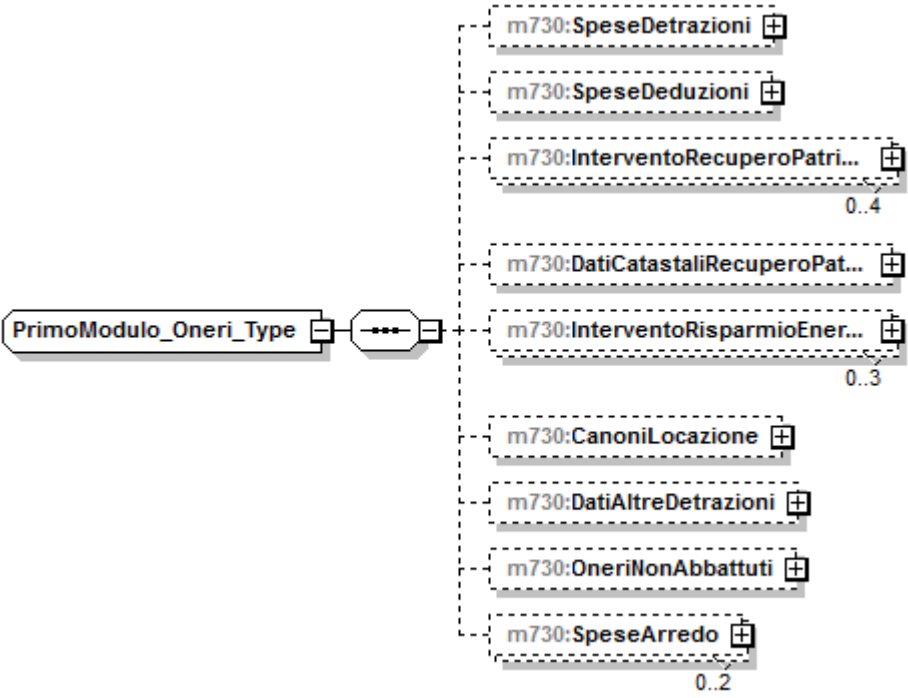
<p>diagram</p>	
<p>namespace</p>	<p>urn:www.agenziaentrate.gov.it:specificheTecniche:sco:730</p>
<p>children</p>	<p>m730:SpeseDetrazioni m730:SpeseDeduzioni m730:InterventoRecuperoPatrimonioEdilizio m730:DatiCatastaliRecuperoPatrimonioEdilizio m730:InterventoRisparmioEnergetico m730:CanoniLocazione m730:DatiAltreDetrazioni m730:OneriNonAbbattuti m730:SpeseArredo</p>
<p>source</p>	<pre><xs:complexType name="PrimoModulo_Oneri_Type"> <xs:sequence> <xs:element name="SpeseDetrazioni" type="m730:Detrazioni_Type" minOccurs="0"/> <xs:element name="SpeseDeduzioni" type="m730:Deduzioni_Type" minOccurs="0"/> <xs:element name="InterventoRecuperoPatrimonioEdilizio" type="m730:Intervento_Recupero_Patrimonio_Edilizio_Type" minOccurs="0" maxOccurs="4"/> <xs:element name="DatiCatastaliRecuperoPatrimonioEdilizio" type="m730:Sezione_Dati_Catastali_Recupero_Patrimonio_Edilizio_Type" minOccurs="0"/> <xs:element name="InterventoRisparmioEnergetico" type="m730:Intervento_Risparmio_Energetico_Type" minOccurs="0" maxOccurs="3"/> <xs:element name="CanoniLocazione" type="m730:Detrazioni_Canoni_Locazione_Type" minOccurs="0"/> <xs:element name="DatiAltreDetrazioni" type="m730:Dati_Altre_Detrazioni_Type" minOccurs="0"/> <xs:element name="OneriNonAbbattuti" type="m730:Oneri_Non_Abbattuti_Type" minOccurs="0"/> <xs:element name="SpeseArredo" type="m730:Spese_Arredo_Type" minOccurs="0" maxOccurs="2"/> </xs:sequence> </xs:complexType></pre>

element **PrimoModulo_Oneri_Type/SpeseDetrazioni**

<p>diagram</p>	
<p>namespace</p>	<p>urn:www.agenziaentrate.gov.it:specificheTecniche:sco:730</p>
<p>type</p>	<p>m730:Detrazioni_Type</p>
<p>children</p>	<p>m730:CasellaRateazione m730:SpeseDeterminatePatologie m730:SpeseSanitarie m730:SpeseFamNonACarico m730:SpeseSanitarieDisabili m730:VeicoliDisabili m730:AcquistoCaniGuida m730:SpeseRateizzate m730:MutuiAbPrincipale m730:AltreSpese</p>
<p>source</p>	<p><xs:element name="SpeseDetrazioni" type="m730:Detrazioni_Type" minOccurs="0"/></p>

element **PrimoModulo_Oneri_Type/SpeseDeduzioni**

<p>diagram</p>	
<p>namespace</p>	<p>urn:www.agenziaentrate.gov.it:specificheTecniche:sco:730</p>
<p>type</p>	<p>m730:Deduzioni_Type</p>
<p>children</p>	<p>m730:ContributiPrevAss m730:AssegnoConiuge m730:ContributiColf m730:ErogazioniIstituzioniReligiose m730:SpesePortatoriHandicap m730:AltriOneri m730:DeducibilitaOrdinaria m730:LavoratoriPrimaOccupazione m730:FondiInSquilibrioFinanziario m730:FamiliariACarico m730:FondoPensioneDipendentiPubblici m730:AcquistoCostruzioneAbitLocazione</p>
<p>source</p>	<p><code><xs:element name="SpeseDeduzioni" type="m730:Deduzioni_Type" minOccurs="0"/></code></p>

element **PrimoModulo_Oneri_Type/InterventoRecuperoPatrimonioEdilizio**

diagram	
namespace	urn:www.agenziaentrate.gov.it:specificheTecniche:sco:730
type	m730:Intervento Recupero Patrimonio Edilizio Type
children	m730:Anno m730:Periodo m730:CodiceFiscale m730:CasellaInterventiParticolari m730:CodiceSituazioniParticolari m730:AnnoSituazioniParticolari m730:RideterminazioneRate m730:NRate m730:Spesa m730:NOrdineImmobile
source	<code><xs:element name="InterventoRecuperoPatrimonioEdilizio" type="m730:Intervento_Recupero_Patrimonio_Edilizio_Type" minOccurs="0" maxOccurs="4"/></code>

element **PrimoModulo_Oneri_Type/DatiCatastaliRecuperoPatrimonioEdilizio**

diagram	
namespace	urn:www.agenziaentrate.gov.it:specificheTecniche:sco:730
type	m730:Sezione Dati Catastali Recupero Patrimonio Edilizio Type
children	m730:DatiCatastaliRecuperoPatrimonioEdilizio m730:DatiRegistrazioneAccatastamentoRecuperoPatrimonio Edilizio
source	<code><xs:element name="DatiCatastaliRecuperoPatrimonioEdilizio" type="m730:Sezione_Dati_Catastali_Recupero_Patrimonio_Edilizio_Type" minOccurs="0"/></code>

element **PrimoModulo_Oneri_Type/InterventoRisparmioEnergetico**

<p>diagram</p>	
<p>namespace</p>	<p>urn:www.agenziaentrate.gov.it:specificheTecniche:sco:730</p>
<p>type</p>	<p>m730:Intervento_Risparmio_Energetico_Type</p>
<p>children</p>	<p>m730:TipoIntervento m730:Anno m730:Periodo2013 m730:CasiParticolari m730:RideterminazioneRate m730:RipartizioneRate m730:NumeroRata m730:Spesa</p>
<p>source</p>	<p><code><xs:element name="InterventoRisparmioEnergetico" type="m730:Intervento_Risparmio_Energetico_Type" minOccurs="0" maxOccurs="3"/></code></p>

element **PrimoModulo_Oneri_Type/CanoniLocazione**

<p>diagram</p>	
<p>namespace</p>	<p>urn:www.agenziaentrate.gov.it:specificheTecniche:sco:730</p>
<p>type</p>	<p>m730:Detrazioni_Canoni_Locazione_Type</p>
<p>children</p>	<p>m730:InquiliniAbitazionePrincipale m730:DipendentiTrasferiti</p>
<p>source</p>	<p><code><xs:element name="CanoniLocazione" type="m730:Detrazioni_Canoni_Locazione_Type" minOccurs="0"/></code></p>

element **PrimoModulo_Oneri_Type/DatiAltreDetrazioni**

diagram	
namespace	urn:www.agenziaentrate.gov.it:specificheTecniche:sco:730
type	m730:Dati_Altre_Detrazioni_Type
children	m730:SpeseCaniGuida m730:AffittoTerreniAgricoliGiovani m730:AltreDetrazioni
source	<xs:element name="DatiAltreDetrazioni" type="m730:Dati_Altre_Detrazioni_Type" minOccurs="0"/>

element **PrimoModulo_Oneri_Type/OneriNonAbbattuti**

diagram	
namespace	urn:www.agenziaentrate.gov.it:specificheTecniche:sco:730
type	m730:Oneri_Non_Abbattuti_Type
children	m730:DetrazSpeseAssPersonale m730:DetrazErogazBiennaleVenezia m730:DetrazErogazSpettacolo m730:DetrazErogazSettoreMusicale m730:DeduzContributiPaesiSviluppo m730:DeduzOnlus m730:DetrazOspedaleGalliera m730:PrevidenzaCompIDipPubblici m730:InteressiMutuiAgrari m730:ArtBonus
source	<xs:element name="OneriNonAbbattuti" type="m730:Oneri_Non_Abbattuti_Type" minOccurs="0"/>

element **PrimoModulo_Oneri_Type/SpeseArredo**

diagram	
namespace	urn:www.agenziaentrate.gov.it:specificheTecniche:sco:730
type	m730:Spese_Arredo_Type
children	m730:NumeroRata m730:Importo
source	<code><xs:element name="SpeseArredo" type="m730:Spese_Arredo_Type" minOccurs="0" maxOccurs="2"/></code>

complexType **Prospetto_Annotazioni_Type**

diagram	
namespace	urn:www.agenziaentrate.gov.it:specificheTecniche:sco:730
children	m730:Modulo_Annotazioni
source	<pre> <xs:complexType name="Prospetto_Annotazioni_Type"> <xs:sequence> <xs:element name="Modulo_Annotazioni" type="m730:Modulo_Annotazioni_Type" maxOccurs="unbounded"/> </xs:sequence> </xs:complexType> </pre>

element **Prospetto_Annotazioni_Type/Modulo_Annotazioni**

diagram	
namespace	urn:www.agenziaentrate.gov.it:specificheTecniche:sco:730
type	m730:Modulo_Annotazioni_Type
children	m730:Annotazione
source	<code><xs:element name="Modulo_Annotazioni" type="m730:Modulo_Annotazioni_Type" maxOccurs="unbounded"/></code>

complexType **Prospetto_Liquidazione_Type**

diagram	
namespace	urn:www.agenziaentrate.gov.it:specificheTecniche:sco:730
children	m730:PrimoModulo m730:Modulo

source	<pre><xs:complexType name="Prospetto_Liquidazione_Type"> <xs:sequence> <xs:element name="PrimoModulo" type="m730:Primo_Modulo_PL_Type"/> <xs:element name="Modulo" type="m730:Modulo_PL_Type" minOccurs="0" maxOccurs="unbounded"/> </xs:sequence> </xs:complexType></pre>
--------	--

element **Prospetto_Liquidazione_Type/PrimoModulo**

diagram	
namespace	urn:www.agenziaentrate.gov.it:specificheTecniche:sco:730
type	m730:Primo_Modulo_PL_Type
children	m730:Prospetto m730:ProspettoRideterminato
source	<pre><xs:element name="PrimoModulo" type="m730:Primo_Modulo_PL_Type"/></pre>

element **Prospetto_Liquidazione_Type/Modulo**

diagram	
namespace	urn:www.agenziaentrate.gov.it:specificheTecniche:sco:730
type	m730:Modulo_PL_Type
children	m730:CredImpEstero
source	<pre><xs:element name="Modulo" type="m730:Modulo_PL_Type" minOccurs="0" maxOccurs="unbounded"/></pre>

complexType **Prospetto_Type**

diagram	
namespace	urn:www.agenziaentrate.gov.it:specificheTecniche:sco:730
children	m730:RiepilogoRedditi m730:ImpostaLorda m730:DetrazioniCrediti m730:ImpostaNetta
source	<pre><xs:complexType name="Prospetto_Type"> <xs:sequence> <xs:element name="RiepilogoRedditi" type="m730:Riepilogo_Redditi_Type" minOccurs="0"/> <xs:element name="ImpostaLorda" type="m730:Imposta_Lorda_Type" minOccurs="0"/> <xs:element name="DetrazioniCrediti" type="m730:Detrazione_Crediti_Type" minOccurs="0"/> </xs:sequence> </xs:complexType></pre>

```
<xs:element name="ImpostaNetta" type="m730:Imposta_Netta_Type" minOccurs="0"/>
</xs:sequence>
</xs:complexType>
```

element **Prospetto_Type/RiepilogoRedditi**

diagram	
namespace	urn:www.agenziaentrate.gov.it:specificheTecniche:sco:730
type	m730:Riepilogo_Redditi_Type
children	m730:Dominicali m730:Agrari m730:Fabbricati m730:LavDip m730:AltriRedditi m730:ImponibileCedolare m730:ImponibileCedolareOrdinario m730:ImponibileCedolareAgevolato m730:AbitazionePrincipalePertinenza
source	<pre><xs:element name="RiepilogoRedditi" type="m730:Riepilogo_Redditi_Type" minOccurs="0"/></pre>

element **Prospetto_Type/ImpostaLorda**

diagram	
namespace	urn:www.agenziaentrate.gov.it:specificheTecniche:sco:730

type	m730:Imposta_Lorda_Type
children	m730:RedditoComplessivo m730:DeduzioneAbitazPrincipale m730:OneriDeducibili m730:RedditoImponibile m730:CompensiAttSport m730:ImportoImpostaLorda
source	<xs:element name="ImpostaLorda" type="m730:Imposta_Lorda_Type" minOccurs="0"/>

element **Prospetto_Type/DetrazioniCrediti**

diagram	
namespace	urn:www.agenziaentrate.gov.it:specificheTecniche:sco:730
type	m730:Detrazione_Crediti_Type
children	m730:DetrazioneConiuge m730:DetrazioneFigli m730:UlterioreDetrazioneFigli m730:DetrazioneFamiliari m730:DetrazioneLavDip m730:DetrazionePens m730:DetrazioneAltriRedditi m730:DetrazioneOneri m730:DetrazioneRistrutturazione m730:DetrazioniArredolmmobili m730:DetrazioneRisparmioEnergetico m730:DetrazioneLocEAgricoliGiochi m730:AltreDetrazioni m730:CreditoPrimaCasa m730:CreditoOccupazione m730:CreditoFondiPensione m730:CreditoMediazioni m730:TotaleDetrazioniCrediti

	m730:DetrazioneLocEAgricoliGiovani m730:AltreDetrazioni m730:CreditoPrimaCasa m730:CreditoOccupazione m730:CreditoFondiPensione m730:CreditoMediazioni m730:TotaleDetrazioniCrediti
source	<xs:element name="DetrazioniCrediti" type="m730:Detrazione_Crediti_Type" minOccurs="0"/>

element **Prospetto_Type/ImpostaNetta**

diagram	
namespace	urn:www.agenziaentrate.gov.it:specificheTecniche:sco:730
type	m730:Imposta_Netta_Type
children	m730:ImportoImpostaNetta m730:CredAltriSisma m730:CredAbitazSisma m730:CredImpEstere m730:CredErogCultura m730:CredCanNonPerc m730:CredDetrazIncapienti m730:Ritenute m730:Differenza m730:EccedenzaIrpef m730:AccontiVersati m730:RestituzioneBonus m730:CredRimborsatiSost m730:BonusIrpefSpettante m730:BonusIrpefRiconosciuto m730:RestituzioneBonusIrpef
source	<xs:element name="ImpostaNetta" type="m730:Imposta_Netta_Type" minOccurs="0"/>

complexType **Quadro_I_Type**

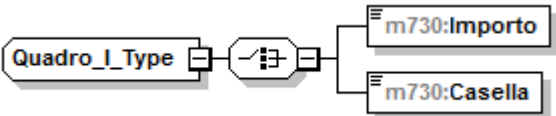
diagram	
namespace	urn:www.agenziaentrate.gov.it:specificheTecniche:sco:730
children	m730:Importo m730:Casella
source	<pre><xs:complexType name="Quadro_I_Type"> <xs:choice> <xs:element name="Importo" type="cm:DatoNP_Type"/> <xs:element name="Casella" type="cm:DatoCB_Type"/> </xs:choice> </xs:complexType></pre>

element **Quadro_I_Type/Importo**

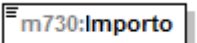
diagram	
namespace	urn:www.agenziaentrate.gov.it:specificheTecniche:sco:730
type	DatoNP_Type
facets	Kind Value pattern [1-9]{1}[0-9]*
source	<pre><xs:element name="Importo" type="cm:DatoNP_Type"/></pre>

element **Quadro_I_Type/Casella**

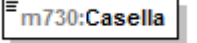
diagram	
namespace	urn:www.agenziaentrate.gov.it:specificheTecniche:sco:730
type	DatoCB_Type
facets	Kind Value pattern [01]
source	<pre><xs:element name="Casella" type="cm:DatoCB_Type"/></pre>

complexType **Redditi_Capitale_Type**

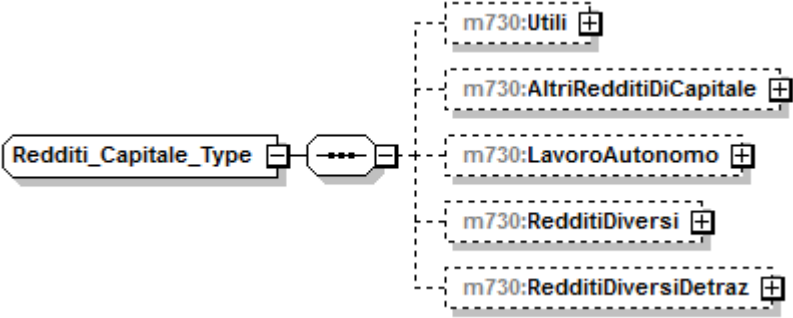
diagram	
namespace	urn:www.agenziaentrate.gov.it:specificheTecniche:sco:730
children	m730:Utili m730:AltriRedditiDiCapitale m730:LavoroAutonomo m730:RedditiDiversi m730:RedditiDiversiDetraz
source	<pre><xs:complexType name="Redditi_Capitale_Type"></pre>

	<pre> <xs:sequence> <xs:element name="Utili" type="m730:Altri_Reddito_Utili_Type" minOccurs="0"/> <xs:element name="AltriRedditiDiCapitale" type="m730:Sezione_Altri_Redd_Type" minOccurs="0"/> <xs:element name="LavoroAutonomo" type="m730:Altri_Reddito_Lavoro_Autonomo_Type" minOccurs="0"/> <xs:element name="RedditiDiversi" type="m730:Altri_Reddito_Diversi_Type" minOccurs="0"/> <xs:element name="RedditiDiversiDetraz" type="m730:Altri_Reddito_Diversi_Detr_Type" minOccurs="0"/> </xs:sequence> </xs:complexType> </pre>
--	---

element **Redditi_Capitale_Type/Utili**

diagram	
namespace	urn:www.agenziaentrate.gov.it:specificheTecniche:sco:730
type	m730:Altri_Reddito_Utili_Type
children	m730:Tipo_Reddito m730:RedditiRitenute
source	<pre><xs:element name="Utili" type="m730:Altri_Reddito_Utili_Type" minOccurs="0"/></pre>

element **Redditi_Capitale_Type/AltriRedditiDiCapitale**

diagram	
namespace	urn:www.agenziaentrate.gov.it:specificheTecniche:sco:730
type	m730:Sezione_Altri_Redd_Type
children	m730:TipoReddito m730:RedditiRitenute
source	<pre><xs:element name="AltriRedditiDiCapitale" type="m730:Sezione_Altri_Redd_Type" minOccurs="0"/></pre>

element **Redditi_Capitale_Type/LavoroAutonomo**

diagram	
namespace	urn:www.agenziaentrate.gov.it:specificheTecniche:sco:730
type	m730:Altri_Reddito_Lavoro_Autonomo_Type
children	m730:TipoReddito m730:RedditiRitenute
source	<pre><xs:element name="LavoroAutonomo" type="m730:Altri_Reddito_Lavoro_Autonomo_Type" minOccurs="0"/></pre>

element **Redditi_Capitale_Type/RedditiDiversi**

diagram	<p>The diagram shows a dashed box labeled 'm730:Altri_Redditi_Diversi_Type'. Inside, a solid box 'm730:RedditiDiversi' is connected to a central connector. This connector is linked to two other elements: a solid box 'm730:TipoReddito' and a dashed box 'm730:RedditiRitenuteSpese' with a plus sign.</p>
namespace	urn:www.agenziaentrate.gov.it:specificheTecniche:sco:730
type	m730:Altri_Redditi_Diversi_Type
children	m730:TipoReddito m730:RedditiRitenuteSpese
source	<xs:element name="RedditiDiversi" type="m730:Altri_Redditi_Diversi_Type" minOccurs="0"/>

element **Redditi_Capitale_Type/RedditiDiversiDetraz**

diagram	<p>The diagram shows a dashed box labeled 'm730:Altri_Redditi_Diversi_Detr_Type'. Inside, a dashed box 'm730:RedditiDiversiDetraz' is connected to a central connector. This connector is linked to two other elements: a solid box 'm730:Tipo_Reddito' and a dashed box 'm730:RedditiRitenuteSpese' with a plus sign.</p>
namespace	urn:www.agenziaentrate.gov.it:specificheTecniche:sco:730
type	m730:Altri_Redditi_Diversi_Detr_Type
children	m730:Tipo_Reddito m730:RedditiRitenuteSpese
source	<xs:element name="RedditiDiversiDetraz" type="m730:Altri_Redditi_Diversi_Detr_Type" minOccurs="0"/>

complexType **Redditi_Eredi_Legatari_Type**

diagram	<p>The diagram shows a solid box 'Redditi_Eredi_Legatari_Type' connected to a central connector. This connector is linked to two other connectors. The top connector is linked to a dashed box labeled 'm730:Tassazione_Separata_Type (extension)', which contains three elements: a dashed box 'm730:Opzione', a solid box 'm730:Anno', and a dashed box 'm730:RedditoRitenute' with a plus sign. The bottom connector is linked to three elements: a solid box 'm730:TipoReddito', a dashed box 'm730:RedditoTotale', and a dashed box 'm730:QuotaImposteSuccessioni'.</p>
namespace	urn:www.agenziaentrate.gov.it:specificheTecniche:sco:730
type	extension of m730:Tassazione_Separata_Type

children	m730:Opzione m730:Anno m730:RedditoRitenute m730:TipoReddito m730:RedditoTotale m730:QuotalmposteSuccessioni
source	<pre><xs:complexType name="Redditi_Eredi_Legatari_Type"> <xs:complexContent> <xs:extension base="m730:Tassazione_Separata_Type"> <xs:sequence> <xs:element name="TipoReddito" type="m730:Tipo_Reddito_Da1a12_Type"/> <xs:element name="RedditoTotale" type="cm:DatoNP_Type" minOccurs="0"/> <xs:element name="QuotalmposteSuccessioni" type="cm:DatoNP_Type" minOccurs="0"/> </xs:sequence> </xs:extension> </xs:complexContent> </xs:complexType></pre>

element **Redditi_Eredi_Legatari_Type/TipoReddito**

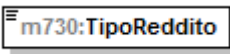
diagram																													
namespace	urn:www.agenziaentrate.gov.it:specificheTecniche:sco:730																												
type	m730:Tipo_Reddito_Da1a12_Type																												
facets	<table border="1"> <thead> <tr> <th>Kind</th> <th>Value</th> </tr> </thead> <tbody> <tr> <td>pattern</td> <td>[1-9]{1}[0-9]*</td> </tr> <tr> <td>enumeration</td> <td>1</td> </tr> <tr> <td>enumeration</td> <td>2</td> </tr> <tr> <td>enumeration</td> <td>3</td> </tr> <tr> <td>enumeration</td> <td>4</td> </tr> <tr> <td>enumeration</td> <td>5</td> </tr> <tr> <td>enumeration</td> <td>6</td> </tr> <tr> <td>enumeration</td> <td>7</td> </tr> <tr> <td>enumeration</td> <td>8</td> </tr> <tr> <td>enumeration</td> <td>9</td> </tr> <tr> <td>enumeration</td> <td>10</td> </tr> <tr> <td>enumeration</td> <td>11</td> </tr> <tr> <td>enumeration</td> <td>12</td> </tr> </tbody> </table>	Kind	Value	pattern	[1-9]{1}[0-9]*	enumeration	1	enumeration	2	enumeration	3	enumeration	4	enumeration	5	enumeration	6	enumeration	7	enumeration	8	enumeration	9	enumeration	10	enumeration	11	enumeration	12
Kind	Value																												
pattern	[1-9]{1}[0-9]*																												
enumeration	1																												
enumeration	2																												
enumeration	3																												
enumeration	4																												
enumeration	5																												
enumeration	6																												
enumeration	7																												
enumeration	8																												
enumeration	9																												
enumeration	10																												
enumeration	11																												
enumeration	12																												
source	<pre><xs:element name="TipoReddito" type="m730:Tipo_Reddito_Da1a12_Type"/></pre>																												

element **Redditi_Eredi_Legatari_Type/RedditoTotale**

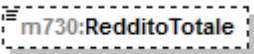
diagram					
namespace	urn:www.agenziaentrate.gov.it:specificheTecniche:sco:730				
type	DatoNP_Type				
facets	<table border="1"> <thead> <tr> <th>Kind</th> <th>Value</th> </tr> </thead> <tbody> <tr> <td>pattern</td> <td>[1-9]{1}[0-9]*</td> </tr> </tbody> </table>	Kind	Value	pattern	[1-9]{1}[0-9]*
Kind	Value				
pattern	[1-9]{1}[0-9]*				
source	<pre><xs:element name="RedditoTotale" type="cm:DatoNP_Type" minOccurs="0"/></pre>				

element **Redditi_Eredi_Legatari_Type/QuotalmposteSuccessioni**

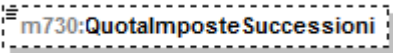
diagram					
namespace	urn:www.agenziaentrate.gov.it:specificheTecniche:sco:730				
type	DatoNP_Type				
facets	<table border="1"> <thead> <tr> <th>Kind</th> <th>Value</th> </tr> </thead> <tbody> <tr> <td>pattern</td> <td>[1-9]{1}[0-9]*</td> </tr> </tbody> </table>	Kind	Value	pattern	[1-9]{1}[0-9]*
Kind	Value				
pattern	[1-9]{1}[0-9]*				
source	<pre><xs:element name="QuotalmposteSuccessioni" type="cm:DatoNP_Type" minOccurs="0"/></pre>				

complexType **Redditi_Fabbricati_Type**

diagram	
namespace	urn:www.agenziaentrate.gov.it:specificheTecniche:sco:730
children	m730:Modulo
source	<pre><xs:complexType name="Redditi_Fabbricati_Type"> <xs:sequence> <xs:element name="Modulo" type="m730:Modulo_Fabbricato_Type" maxOccurs="unbounded"/> </xs:sequence> </xs:complexType></pre>

element **Redditi_Fabbricati_Type/Modulo**

diagram	
namespace	urn:www.agenziaentrate.gov.it:specificheTecniche:sco:730
type	m730:Modulo_Fabbricato_Type
children	m730:FabbricatoOrd m730:FabbricatoAgev
source	<pre><xs:element name="Modulo" type="m730:Modulo_Fabbricato_Type" maxOccurs="unbounded"/></pre>

complexType **Redditi_Lavoro_Dip_Type**

diagram	
namespace	urn:www.agenziaentrate.gov.it:specificheTecniche:sco:730
children	m730:PrimoModulo m730:Modulo
source	<pre><xs:complexType name="Redditi_Lavoro_Dip_Type"> <xs:annotation> <xs:documentation>Quadro C - Redditi di Lavoro Dipendente e Assimilati</xs:documentation> </xs:annotation> <xs:sequence> <xs:element name="PrimoModulo" type="m730:Primo_Modulo_Lavoro_Dip_Type"/> <xs:element name="Modulo" type="m730:Modulo_Lavoro_Dip_Type" minOccurs="0" maxOccurs="unbounded"/> </xs:sequence> </xs:complexType></pre>

element **Redditi_Lavoro_Dip_Type/PrimoModulo**

<p>diagram</p>	
<p>namespace</p>	<p>urn:www.agenziaentrate.gov.it:specificheTecniche:sco:730</p>
<p>type</p>	<p>m730:Primo_Modulo_Lavoro_Dip_Type</p>
<p>children</p>	<p>m730:LavoroDipendente m730:IncrementoProduttivita m730:PeriodoLavoro m730:AltriRedditiAssLavDip m730:RitenuteLavoroDipendente m730:Bonuslrpef m730:RedditoAlNettoContribPensioni m730:ContribSolidarietaTrattenuato m730:CasellaCasiParticolari</p>
<p>source</p>	<p><code><xs:element name="PrimoModulo" type="m730:Primo_Modulo_Lavoro_Dip_Type"/></code></p>

element **Redditi_Lavoro_Dip_Type/Modulo**

<p>diagram</p>	
<p>namespace</p>	<p>urn:www.agenziaentrate.gov.it:specificheTecniche:sco:730</p>
<p>type</p>	<p>m730:Modulo_Lavoro_Dip_Type</p>
<p>children</p>	<p>m730:LavoroDipendente m730:AltriRedditiAssLavDip</p>
<p>source</p>	<p><code><xs:element name="Modulo" type="m730:Modulo_Lavoro_Dip_Type" minOccurs="0" maxOccurs="unbounded"/></code></p>

complexType **Redditi_Ritenute_Spese_Type**

diagram	
namespace	urn:www.agenziaentrate.gov.it:specificheTecniche:sco:730
type	extension of m730:Redditi_Ritenute_Type
children	m730:ImportoRedditi m730:ImportoRitenute m730:ImportoSpese
source	<pre><xs:complexType name="Redditi_Ritenute_Spese_Type"> <xs:complexContent> <xs:extension base="m730:Redditi_Ritenute_Type"> <xs:sequence> <xs:element name="ImportoSpese" type="cm:DatoNP_Type" minOccurs="0"/> </xs:sequence> </xs:extension> </xs:complexContent> </xs:complexType></pre>

element **Redditi_Ritenute_Spese_Type/ImportoSpese**

diagram					
namespace	urn:www.agenziaentrate.gov.it:specificheTecniche:sco:730				
type	DatoNP_Type				
facets	<table border="1"> <thead> <tr> <th>Kind</th> <th>Value</th> </tr> </thead> <tbody> <tr> <td>pattern</td> <td>[1-9]{1}[0-9]*</td> </tr> </tbody> </table>	Kind	Value	pattern	[1-9]{1}[0-9]*
Kind	Value				
pattern	[1-9]{1}[0-9]*				
source	<pre><xs:element name="ImportoSpese" type="cm:DatoNP_Type" minOccurs="0"/></pre>				

complexType **Redditi_Ritenute_Type**

diagram	
namespace	urn:www.agenziaentrate.gov.it:specificheTecniche:sco:730
children	m730:ImportoRedditi m730:ImportoRitenute
source	<pre><xs:complexType name="Redditi_Ritenute_Type"> <xs:sequence> <xs:element name="ImportoRedditi" type="cm:DatoNP_Type" minOccurs="0"/> <xs:element name="ImportoRitenute" type="cm:DatoNP_Type" minOccurs="0"/> </xs:sequence> </xs:complexType></pre>

element **Redditi_Ritenute_Type/ImportoRedditi**

diagram					
namespace	urn:www.agenziaentrate.gov.it:specificheTecniche:sco:730				
type	DatoNP_Type				
facets	<table border="1"> <thead> <tr> <th>Kind</th> <th>Value</th> </tr> </thead> <tbody> <tr> <td>pattern</td> <td>[1-9]{1}[0-9]*</td> </tr> </tbody> </table>	Kind	Value	pattern	[1-9]{1}[0-9]*
Kind	Value				
pattern	[1-9]{1}[0-9]*				
source	<xs:element name="ImportoRedditi" type="cm:DatoNP_Type" minOccurs="0"/>				

element **Redditi_Ritenute_Type/ImportoRitenute**

diagram					
namespace	urn:www.agenziaentrate.gov.it:specificheTecniche:sco:730				
type	DatoNP_Type				
facets	<table border="1"> <thead> <tr> <th>Kind</th> <th>Value</th> </tr> </thead> <tbody> <tr> <td>pattern</td> <td>[1-9]{1}[0-9]*</td> </tr> </tbody> </table>	Kind	Value	pattern	[1-9]{1}[0-9]*
Kind	Value				
pattern	[1-9]{1}[0-9]*				
source	<xs:element name="ImportoRitenute" type="cm:DatoNP_Type" minOccurs="0"/>				

complexType **Redditi_Tassazione_Separata_Type**

diagram	
namespace	urn:www.agenziaentrate.gov.it:specificheTecniche:sco:730
children	m730:RedditiErede m730:ImposteRimborsate
source	<pre><xs:complexType name="Redditi_Tassazione_Separata_Type"> <xs:sequence> <xs:element name="RedditiErede" type="m730:Redditi_Eredi_Legatari_Type" minOccurs="0"/> <xs:element name="ImposteRimborsate" type="m730:Imposte_Rimborsate_Type" minOccurs="0"/> </xs:sequence> </xs:complexType></pre>

element **Redditi_Tassazione_Separata_Type/RedditiErede**

diagram	
namespace	urn:www.agenziaentrate.gov.it:specificheTecniche:sco:730
type	m730:Redditi_Eredi_Legatari_Type
children	m730:Opzione m730:Anno m730:RedditoRitenute m730:TipoReddito m730:RedditoTotale m730:QuotaImposteSuccessioni
source	<code><xs:element name="RedditiErede" type="m730:Redditi_Eredi_Legatari_Type" minOccurs="0"/></code>

element **Redditi_Tassazione_Separata_Type/ImposteRimborsate**

diagram	
namespace	urn:www.agenziaentrate.gov.it:specificheTecniche:sco:730
type	m730:Imposte_Rimborsate_Type
children	m730:TipoReddito m730:TassazioneSeparata
source	<code><xs:element name="ImposteRimborsate" type="m730:Imposte_Rimborsate_Type" minOccurs="0"/></code>

complexType **Redditi_Terreni_Type**

diagram	
namespace	urn:www.agenziaentrate.gov.it:specificheTecniche:sco:730
children	m730:Modulo
source	<code><xs:complexType name="Redditi_Terreni_Type"> <xs:sequence> <xs:element name="Modulo" type="m730:Modulo_Terreno_Type" maxOccurs="unbounded"/> </xs:sequence> </xs:complexType></code>

element **Redditi_Terreni_Type/Modulo**

diagram	
namespace	urn:www.agenziaentrate.gov.it:specificheTecniche:sco:730
type	m730:Modulo_Terreno_Type
children	m730:Terreno
source	<code><xs:element name="Modulo" type="m730:Modulo_Terreno_Type" maxOccurs="unbounded"/></code>

complexType **Reddito_Erede_Type**

diagram	
namespace	urn:www.agenziaentrate.gov.it:specificheTecniche:sco:730
type	extension of m730:Tassazione_Separata_Type
children	m730:Opzione m730:Anno m730:RedditoRitenute
source	<pre> <xs:complexType name="Reddito_Erede_Type"> <xs:complexContent> <xs:extension base="m730:Tassazione_Separata_Type"/> </xs:complexContent> </xs:complexType> </pre>

complexType **Residenza_Anagrafica_730_Type**

diagram	
namespace	urn:www.agenziaentrate.gov.it:specificheTecniche:sco:730
type	extension of Residenza_Anagrafica_Type
children	Comune Provincia CodiceComune Indirizzo Cap DataVariazione m730:Tipologia m730:NumCivico m730:Frazione m730:PrimaPresentazione
source	<pre> <xs:complexType name="Residenza_Anagrafica_730_Type"> <xs:complexContent> <xs:extension base="sc:Residenza_Anagrafica_Type"> <xs:sequence> <xs:element name="Tipologia" type="cm:DatoAN_Type" minOccurs="0"/> <xs:element name="NumCivico" type="cm:DatoAN_Type" minOccurs="0"/> <xs:element name="Frazione" type="cm:DatoAN_Type" minOccurs="0"/> <xs:element name="PrimaPresentazione" type="cm:DatoCB_Type" minOccurs="0"/> </xs:sequence> </xs:extension> </xs:complexContent> </xs:complexType> </pre>

element **Residenza_Anagrafica_730_Type/Tipologia**

diagram					
namespace	urn:www.agenziaentrate.gov.it:specificheTecniche:sco:730				
type	DatoAN_Type				
facets	<table border="1"> <thead> <tr> <th>Kind</th> <th>Value</th> </tr> </thead> <tbody> <tr> <td>pattern</td> <td>([0-9A-Z-] \&quot;){1}([0-9A-Z&amp;#39; \- \., / \^\(\)\ À É È Ì Ò Ù Û &quot; \ \ \\ +)*</td> </tr> </tbody> </table>	Kind	Value	pattern	([0-9A-Z-] \"){1}([0-9A-Z&#39; \- \., / \^\(\)\ À É È Ì Ò Ù Û " \ \ \\ +)*
Kind	Value				
pattern	([0-9A-Z-] \"){1}([0-9A-Z&#39; \- \., / \^\(\)\ À É È Ì Ò Ù Û " \ \ \\ +)*				
source	<pre><xs:element name="Tipologia" type="cm:DatoAN_Type" minOccurs="0"/></pre>				

element **Residenza_Anagrafica_730_Type/NumCivico**

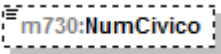
diagram					
namespace	urn:www.agenziaentrate.gov.it:specificheTecniche:sco:730				
type	DatoAN_Type				
facets	<table border="1"> <thead> <tr> <th>Kind</th> <th>Value</th> </tr> </thead> <tbody> <tr> <td>pattern</td> <td>(([0-9A-Z\-\]]&quot;){1}([0-9A-Z&amp;:] \-\ \.\ / ^ \^\(\ \)\ À É È Ì Ò Ù Û &quot; \ \ \ +)*</td> </tr> </tbody> </table>	Kind	Value	pattern	(([0-9A-Z\-\]]"){1}([0-9A-Z&:] \-\ \.\ / ^ \^\(\ \)\ À É È Ì Ò Ù Û " \ \ \ +)*
Kind	Value				
pattern	(([0-9A-Z\-\]]"){1}([0-9A-Z&:] \-\ \.\ / ^ \^\(\ \)\ À É È Ì Ò Ù Û " \ \ \ +)*				
source	<xs:element name="NumCivico" type="cm:DatoAN_Type" minOccurs="0"/>				

element **Residenza_Anagrafica_730_Type/Frazione**

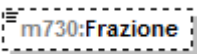
diagram					
namespace	urn:www.agenziaentrate.gov.it:specificheTecniche:sco:730				
type	DatoAN_Type				
facets	<table border="1"> <thead> <tr> <th>Kind</th> <th>Value</th> </tr> </thead> <tbody> <tr> <td>pattern</td> <td>(([0-9A-Z\-\]]&quot;){1}([0-9A-Z&amp;:] \-\ \.\ / ^ \^\(\ \)\ À É È Ì Ò Ù Û &quot; \ \ \ +)*</td> </tr> </tbody> </table>	Kind	Value	pattern	(([0-9A-Z\-\]]"){1}([0-9A-Z&:] \-\ \.\ / ^ \^\(\ \)\ À É È Ì Ò Ù Û " \ \ \ +)*
Kind	Value				
pattern	(([0-9A-Z\-\]]"){1}([0-9A-Z&:] \-\ \.\ / ^ \^\(\ \)\ À É È Ì Ò Ù Û " \ \ \ +)*				
source	<xs:element name="Frazione" type="cm:DatoAN_Type" minOccurs="0"/>				

element **Residenza_Anagrafica_730_Type/PrimaPresentazione**

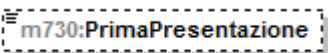
diagram					
namespace	urn:www.agenziaentrate.gov.it:specificheTecniche:sco:730				
type	DatoCB_Type				
facets	<table border="1"> <thead> <tr> <th>Kind</th> <th>Value</th> </tr> </thead> <tbody> <tr> <td>pattern</td> <td>[01]</td> </tr> </tbody> </table>	Kind	Value	pattern	[01]
Kind	Value				
pattern	[01]				
source	<xs:element name="PrimaPresentazione" type="cm:DatoCB_Type" minOccurs="0"/>				

facets	Kind Value pattern ([0-9A-Z-] \"){1}([0-9A-Z&#39; \" \- _ / ° \"^\(\\) À É È Ì Ò Ù Ú Û " \\ \\ \\ +)*
source	<xs:element name="NumCivico" type="cm:DatoAN_Type" minOccurs="0"/>

element **Residenza_Rappresentante_Type/Frazione**

diagram	
namespace	urn:www.agenziaentrate.gov.it:specificheTecniche:sco:730
type	DatoAN_Type
facets	Kind Value pattern ([0-9A-Z-] \"){1}([0-9A-Z&#39; \" \- _ / ° \"^\(\\) À É È Ì Ò Ù Ú Û " \\ \\ \\ +)*
source	<xs:element name="Frazione" type="cm:DatoAN_Type" minOccurs="0"/>

complexType **Residenza_Type**

diagram	
namespace	urn:www.agenziaentrate.gov.it:specificheTecniche:sco:730
children	m730:Comune m730:Provincia m730:CodiceComune m730:Cap m730:Tipologia m730:Indirizzo m730:NumCivico m730:Frazione m730:Email m730:Telefono
source	<xs:complexType name="Residenza_Type"> <xs:sequence> <xs:element name="Comune" type="cm:DatoAN_Type" minOccurs="0"/> <xs:element name="Provincia" type="cm:PR_Type" minOccurs="0"/> <xs:element name="CodiceComune" type="cm:DatoAN_Type" minOccurs="0"/> <xs:element name="Cap" type="cm:DatoAN_Type" minOccurs="0"/> <xs:element name="Tipologia" type="cm:DatoAN_Type" minOccurs="0"/> <xs:element name="Indirizzo" type="cm:DatoAN_Type" minOccurs="0"/> <xs:element name="NumCivico" type="cm:DatoAN_Type" minOccurs="0"/> <xs:element name="Frazione" type="cm:DatoAN_Type" minOccurs="0"/> <xs:element name="Email" type="cm:DatoEM_Type" minOccurs="0"/> <xs:element name="Telefono" type="cm:DatoAN_Type" minOccurs="0"/> </xs:sequence> </xs:complexType>

element **Residenza_Type/Comune**

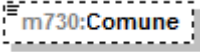
diagram	
namespace	urn:www.agenziaentrate.gov.it:specificheTecniche:sco:730
type	DatoAN_Type
facets	Kind Value pattern ([0-9A-Z- "}{1}{[0-9A-Z&] " - \., / "^\(\\) À É È Ì Ò Ù Û "; \\ /+)*
source	<xs:element name="Comune" type="cm:DatoAN_Type" minOccurs="0"/>

element **Residenza_Type/Provincia**

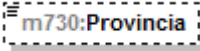
diagram	
namespace	urn:www.agenziaentrate.gov.it:specificheTecniche:sco:730
type	PR_Type
source	<xs:element name="Provincia" type="cm:PR_Type" minOccurs="0"/>

element **Residenza_Type/CodiceComune**

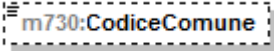
diagram	
namespace	urn:www.agenziaentrate.gov.it:specificheTecniche:sco:730
type	DatoAN_Type
facets	Kind Value pattern ([0-9A-Z- "}{1}{[0-9A-Z&] " - \., / "^\(\\) À É È Ì Ò Ù Û "; \\ /+)*
source	<xs:element name="CodiceComune" type="cm:DatoAN_Type" minOccurs="0"/>

element **Residenza_Type/Cap**

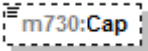
diagram	
namespace	urn:www.agenziaentrate.gov.it:specificheTecniche:sco:730
type	DatoAN_Type
facets	Kind Value pattern ([0-9A-Z- "}{1}{[0-9A-Z&] " - \., / "^\(\\) À É È Ì Ò Ù Û "; \\ /+)*
source	<xs:element name="Cap" type="cm:DatoAN_Type" minOccurs="0"/>

element **Residenza_Type/Tipologia**

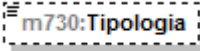
diagram	
namespace	urn:www.agenziaentrate.gov.it:specificheTecniche:sco:730
type	DatoAN_Type
facets	Kind Value pattern ([0-9A-Z- "}{1}{[0-9A-Z&] " - \., / "^\(\\) À É È Ì Ò Ù Û "; \\ /+)*
source	<xs:element name="Tipologia" type="cm:DatoAN_Type" minOccurs="0"/>

element **Residenza_Type/Indirizzo**

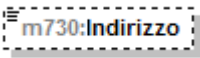
diagram	
namespace	urn:www.agenziaentrate.gov.it:specificheTecniche:sco:730
type	DatoAN_Type
facets	Kind Value pattern ([0-9A-Z\-\-]*)"}{1}([0-9A-Z&:] ' \" data-bbox="194 203 721 228"/>
source	<xs:element name="Indirizzo" type="cm:DatoAN_Type" minOccurs="0"/>

element **Residenza_Type/NumCivico**

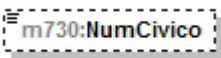
diagram	
namespace	urn:www.agenziaentrate.gov.it:specificheTecniche:sco:730
type	DatoAN_Type
facets	Kind Value pattern ([0-9A-Z\-\-]*)"}{1}([0-9A-Z&:] ' \" data-bbox="194 369 721 394"/>
source	<xs:element name="NumCivico" type="cm:DatoAN_Type" minOccurs="0"/>

element **Residenza_Type/Frazione**

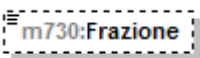
diagram	
namespace	urn:www.agenziaentrate.gov.it:specificheTecniche:sco:730
type	DatoAN_Type
facets	Kind Value pattern ([0-9A-Z\-\-]*)"}{1}([0-9A-Z&:] ' \" data-bbox="194 537 721 562"/>
source	<xs:element name="Frazione" type="cm:DatoAN_Type" minOccurs="0"/>

element **Residenza_Type/Email**

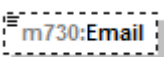
diagram	
namespace	urn:www.agenziaentrate.gov.it:specificheTecniche:sco:730
type	DatoEM_Type
facets	Kind Value pattern [a-zA-Z0-9._%'\-"?^~=]+@[a-zA-Z0-9.\-]+\.[a-zA-Z]{2,4}
source	<xs:element name="Email" type="cm:DatoEM_Type" minOccurs="0"/>

element **Residenza_Type/Telefono**

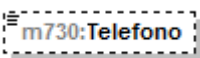
diagram	
namespace	urn:www.agenziaentrate.gov.it:specificheTecniche:sco:730
type	DatoAN_Type
facets	Kind Value pattern ([0-9A-Z\-\-]*)"}{1}([0-9A-Z&:] ' \" data-bbox="194 873 721 898"/>

source	<code><xs:element name="Telefono" type="cm:DatoAN_Type" minOccurs="0"/></code>
--------	--

complexType **Residuo_Credito_Compens_Annolmposta_Type**

diagram	
namespace	urn:www.agenziaentrate.gov.it:specificheTecniche:sco:730
type	extension of m730:Residuo_Credito_Compens_Type
children	m730:CreditoAnno m730:DiCuiCompensatoF24
source	<pre> <xs:complexType name="Residuo_Credito_Compens_Annolmposta_Type"> <xs:complexContent> <xs:extension base="m730:Residuo_Credito_Compens_Type"/> </xs:complexContent> </xs:complexType> </pre>

complexType **Residuo_Credito_Compens_Type**

diagram	
namespace	urn:www.agenziaentrate.gov.it:specificheTecniche:sco:730
children	m730:CreditoAnno m730:DiCuiCompensatoF24
source	<pre> <xs:complexType name="Residuo_Credito_Compens_Type"> <xs:sequence> <xs:element name="CreditoAnno" type="cm:DatoNP_Type" minOccurs="0"/> <xs:element name="DiCuiCompensatoF24" type="cm:DatoNP_Type" minOccurs="0"/> </xs:sequence> </xs:complexType> </pre>

element **Residuo_Credito_Compens_Type/CreditoAnno**

diagram					
namespace	urn:www.agenziaentrate.gov.it:specificheTecniche:sco:730				
type	DatoNP_Type				
facets	<table border="1"> <tr> <td>Kind</td> <td>Value</td> </tr> <tr> <td>pattern</td> <td>[1-9]{1}[0-9]*</td> </tr> </table>	Kind	Value	pattern	[1-9]{1}[0-9]*
Kind	Value				
pattern	[1-9]{1}[0-9]*				
source	<code><xs:element name="CreditoAnno" type="cm:DatoNP_Type" minOccurs="0"/></code>				

element **Residuo_Credito_Compens_Type/DiCuiCompensatoF24**

diagram	
namespace	urn:www.agenziaentrate.gov.it:specificheTecniche:sco:730

type	DatoNP_Type
facets	Kind Value pattern [1-9]{1}[0-9]*
source	<xs:element name="DiCuiCompensatoF24" type="cm:DatoNP_Type" minOccurs="0"/>

complexType Rettifica_Type

diagram	
namespace	urn:www.agenziaentrate.gov.it:specificheTecniche:sco:730
children	m730:Quadro m730:Rigo m730:Colonna m730:Modulo m730:DatoRimosso
source	<pre><xs:complexType name="Rettifica_Type"> <xs:sequence> <xs:element name="Quadro" type="cm:DatoAN_Type"/> <xs:element name="Rigo" type="cm:DatoNP_Type"/> <xs:element name="Colonna" type="cm:DatoNP_Type" minOccurs="0"/> <xs:element name="Modulo" type="cm:DatoNP_Type"/> <xs:element name="DatoRimosso" type="cm:DatoCB_Type" minOccurs="0"/> </xs:sequence> </xs:complexType></pre>

element Rettifica_Type/Quadro

diagram	
namespace	urn:www.agenziaentrate.gov.it:specificheTecniche:sco:730
type	DatoAN_Type
facets	Kind Value pattern ([0-9A-Z-] \"){1}([0-9A-Z&] ! - \., / \^\(\ \) \Â \É \È \Ì \Ò \Ù \Û \" \ \ \ +)*
source	<xs:element name="Quadro" type="cm:DatoAN_Type"/>

element Rettifica_Type/Rigo

diagram	
namespace	urn:www.agenziaentrate.gov.it:specificheTecniche:sco:730
type	DatoNP_Type
facets	Kind Value pattern [1-9]{1}[0-9]*
source	<xs:element name="Rigo" type="cm:DatoNP_Type"/>

element **Rettifica_Type/Colonna**

diagram					
namespace	urn:www.agenziaentrate.gov.it:specificheTecniche:sco:730				
type	DatoNP_Type				
facets	<table border="1"> <tr> <td>Kind</td> <td>Value</td> </tr> <tr> <td>pattern</td> <td>[1-9]{1}[0-9]*</td> </tr> </table>	Kind	Value	pattern	[1-9]{1}[0-9]*
Kind	Value				
pattern	[1-9]{1}[0-9]*				
source	<xs:element name="Colonna" type="cm:DatoNP_Type" minOccurs="0"/>				

element **Rettifica_Type/Modulo**

diagram					
namespace	urn:www.agenziaentrate.gov.it:specificheTecniche:sco:730				
type	DatoNP_Type				
facets	<table border="1"> <tr> <td>Kind</td> <td>Value</td> </tr> <tr> <td>pattern</td> <td>[1-9]{1}[0-9]*</td> </tr> </table>	Kind	Value	pattern	[1-9]{1}[0-9]*
Kind	Value				
pattern	[1-9]{1}[0-9]*				
source	<xs:element name="Modulo" type="cm:DatoNP_Type"/>				

element **Rettifica_Type/DatoRimosso**

diagram					
namespace	urn:www.agenziaentrate.gov.it:specificheTecniche:sco:730				
type	DatoCB_Type				
facets	<table border="1"> <tr> <td>Kind</td> <td>Value</td> </tr> <tr> <td>pattern</td> <td>[01]</td> </tr> </table>	Kind	Value	pattern	[01]
Kind	Value				
pattern	[01]				
source	<xs:element name="DatoRimosso" type="cm:DatoCB_Type" minOccurs="0"/>				

complexType **Riepilogo_Redditi_Type**

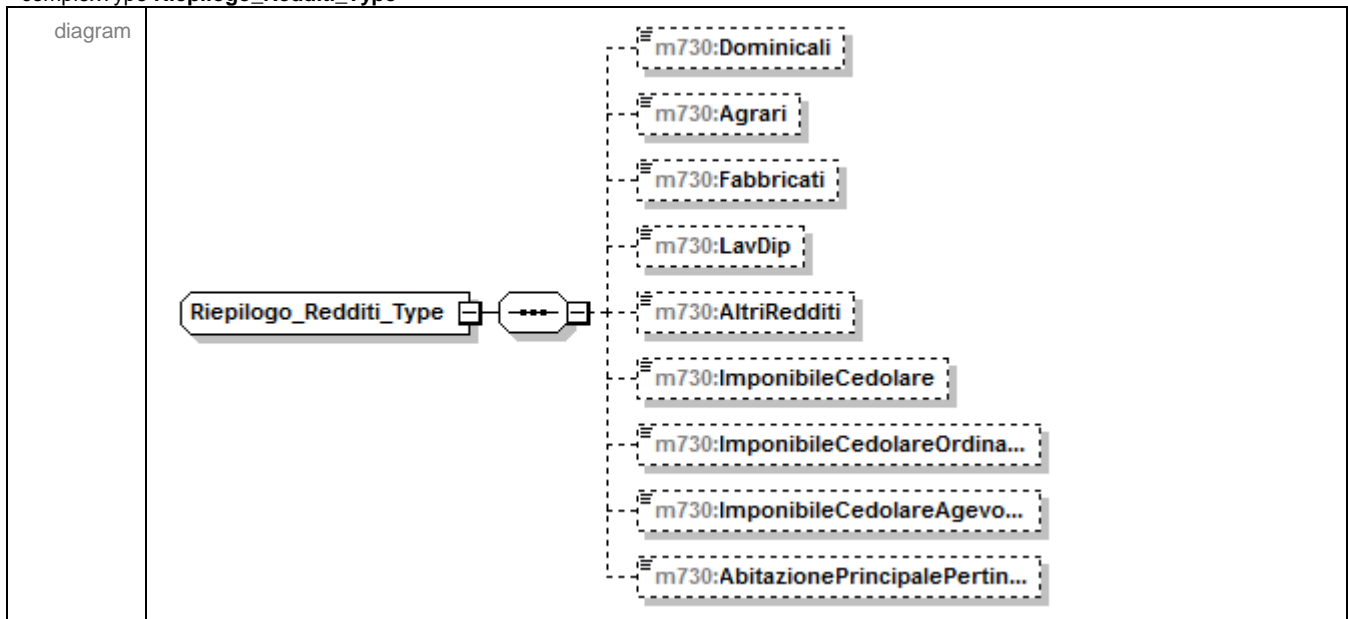

namespace	urn:www.agenziaentrate.gov.it:specificheTecniche:sco:730
children	m730:Dominicali m730:Agrari m730:Fabbricati m730:LavDip m730:AltriRedditi m730:ImponibileCedolare m730:ImponibileCedolareOrdinario m730:ImponibileCedolareAgevolato m730:AbitazionePrincipalePertinenze
source	<xs:complexType name="Riepilogo_Redditi_Type"> <xs:sequence> <xs:element name="Dominicali" type="cm:DatoNP_Type" minOccurs="0"/> <xs:element name="Agrari" type="cm:DatoNP_Type" minOccurs="0"/> <xs:element name="Fabbricati" type="cm:DatoNP_Type" minOccurs="0"/> <xs:element name="LavDip" type="cm:DatoNP_Type" minOccurs="0"/> <xs:element name="AltriRedditi" type="cm:DatoNP_Type" minOccurs="0"/> <xs:element name="ImponibileCedolare" type="cm:DatoNP_Type" minOccurs="0"/> <xs:element name="ImponibileCedolareOrdinario" type="cm:DatoNP_Type" minOccurs="0"/> <xs:element name="ImponibileCedolareAgevolato" type="cm:DatoNP_Type" minOccurs="0"/> <xs:element name="AbitazionePrincipalePertinenze" type="cm:DatoNP_Type" minOccurs="0"/> </xs:sequence> </xs:complexType>

element Riepilogo_Redditi_Type/Dominicali

diagram	
namespace	urn:www.agenziaentrate.gov.it:specificheTecniche:sco:730
type	DatoNP_Type
facets	Kind Value pattern [1-9]{1}[0-9]*
source	<xs:element name="Dominicali" type="cm:DatoNP_Type" minOccurs="0"/>

element Riepilogo_Redditi_Type/Agrari

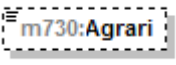
diagram	
namespace	urn:www.agenziaentrate.gov.it:specificheTecniche:sco:730
type	DatoNP_Type
facets	Kind Value pattern [1-9]{1}[0-9]*
source	<xs:element name="Agrari" type="cm:DatoNP_Type" minOccurs="0"/>

element Riepilogo_Redditi_Type/Fabbricati

diagram	
namespace	urn:www.agenziaentrate.gov.it:specificheTecniche:sco:730
type	DatoNP_Type
facets	Kind Value pattern [1-9]{1}[0-9]*
source	<xs:element name="Fabbricati" type="cm:DatoNP_Type" minOccurs="0"/>

element Riepilogo_Redditi_Type/LavDip

diagram	
---------	---

namespace	urn:www.agenziaentrate.gov.it:specificheTecniche:sco:730
type	DatoNP_Type
facets	Kind Value pattern [1-9]{1}[0-9]*
source	<xs:element name="LavDip" type="cm:DatoNP_Type" minOccurs="0"/>

element **Riepilogo_Reddito_Type/AltriRedditi**

diagram	
namespace	urn:www.agenziaentrate.gov.it:specificheTecniche:sco:730
type	DatoNP_Type
facets	Kind Value pattern [1-9]{1}[0-9]*
source	<xs:element name="AltriRedditi" type="cm:DatoNP_Type" minOccurs="0"/>

element **Riepilogo_Reddito_Type/ImponibileCedolare**

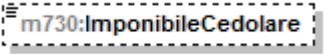
diagram	
namespace	urn:www.agenziaentrate.gov.it:specificheTecniche:sco:730
type	DatoNP_Type
facets	Kind Value pattern [1-9]{1}[0-9]*
source	<xs:element name="ImponibileCedolare" type="cm:DatoNP_Type" minOccurs="0"/>

element **Riepilogo_Reddito_Type/ImponibileCedolareOrdinario**

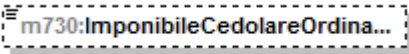
diagram	
namespace	urn:www.agenziaentrate.gov.it:specificheTecniche:sco:730
type	DatoNP_Type
facets	Kind Value pattern [1-9]{1}[0-9]*
source	<xs:element name="ImponibileCedolareOrdinario" type="cm:DatoNP_Type" minOccurs="0"/>

element **Riepilogo_Reddito_Type/ImponibileCedolareAgevolato**

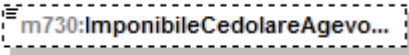
diagram	
namespace	urn:www.agenziaentrate.gov.it:specificheTecniche:sco:730
type	DatoNP_Type
facets	Kind Value pattern [1-9]{1}[0-9]*
source	<xs:element name="ImponibileCedolareAgevolato" type="cm:DatoNP_Type" minOccurs="0"/>

element **Riepilogo_Redditi_Type/AbitazionePrincipalePertinenze**

diagram					
namespace	urn:www.agenziaentrate.gov.it:specificheTecniche:sco:730				
type	DatoNP_Type				
facets	<table border="1"> <thead> <tr> <th>Kind</th> <th>Value</th> </tr> </thead> <tbody> <tr> <td>pattern</td> <td>[1-9]{1}[0-9]*</td> </tr> </tbody> </table>	Kind	Value	pattern	[1-9]{1}[0-9]*
Kind	Value				
pattern	[1-9]{1}[0-9]*				
source	<xs:element name="AbitazionePrincipalePertinenze" type="cm:DatoNP_Type" minOccurs="0"/>				

complexType **Ritenute_Acconti_Sospesi_Type**

diagram	
namespace	urn:www.agenziaentrate.gov.it:specificheTecniche:sco:730
children	m730:CodiceEvento m730:Irpel m730:AddRegionaleIrpel m730:AddComunaleIrpel m730:SostitutivaProduttivita m730:CedolareSecca m730:ContribSolidarieta
source	<pre><xs:complexType name="Ritenute_Acconti_Sospesi_Type"> <xs:sequence> <xs:element name="CodiceEvento" type="m730:Codice_Evento_Eccezionale_Type" minOccurs="0"/> <xs:element name="Irpel" type="cm:DatoNP_Type" minOccurs="0"/> <xs:element name="AddRegionaleIrpel" type="cm:DatoNP_Type" minOccurs="0"/> <xs:element name="AddComunaleIrpel" type="cm:DatoNP_Type" minOccurs="0"/> <xs:element name="SostitutivaProduttivita" type="cm:DatoNP_Type" minOccurs="0"/> <xs:element name="CedolareSecca" type="cm:DatoNP_Type" minOccurs="0"/> <xs:element name="ContribSolidarieta" type="cm:DatoNP_Type" minOccurs="0"/> </xs:sequence> </xs:complexType></pre>

element **Ritenute_Acconti_Sospesi_Type/CodiceEvento**

diagram															
namespace	urn:www.agenziaentrate.gov.it:specificheTecniche:sco:730														
type	m730:Codice_Evento_Eccezionale_Type														
facets	<table border="1"> <thead> <tr> <th>Kind</th> <th>Value</th> </tr> </thead> <tbody> <tr> <td>pattern</td> <td>[1-9]</td> </tr> <tr> <td>enumeration</td> <td>1</td> </tr> <tr> <td>enumeration</td> <td>2</td> </tr> <tr> <td>enumeration</td> <td>3</td> </tr> <tr> <td>enumeration</td> <td>4</td> </tr> <tr> <td>enumeration</td> <td>5</td> </tr> </tbody> </table>	Kind	Value	pattern	[1-9]	enumeration	1	enumeration	2	enumeration	3	enumeration	4	enumeration	5
Kind	Value														
pattern	[1-9]														
enumeration	1														
enumeration	2														
enumeration	3														
enumeration	4														
enumeration	5														

	enumeration 6 enumeration 7 enumeration 8
source	<xs:element name="CodiceEvento" type="m730:Codice_Evento_Eccezionale_Type" minOccurs="0"/>

element **Ritenute_Acconti_Sospesi_Type/Irpef**

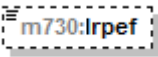
diagram	
namespace	urn:www.agenziaentrate.gov.it:specificheTecniche:sco:730
type	DatoNP_Type
facets	Kind Value pattern [1-9]{1}[0-9]*
source	<xs:element name="Irpef" type="cm:DatoNP_Type" minOccurs="0"/>

element **Ritenute_Acconti_Sospesi_Type/AddRegionaleIrpef**

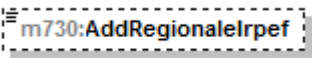
diagram	
namespace	urn:www.agenziaentrate.gov.it:specificheTecniche:sco:730
type	DatoNP_Type
facets	Kind Value pattern [1-9]{1}[0-9]*
source	<xs:element name="AddRegionaleIrpef" type="cm:DatoNP_Type" minOccurs="0"/>

element **Ritenute_Acconti_Sospesi_Type/AddComunaleIrpef**

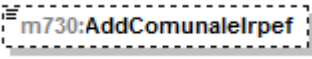
diagram	
namespace	urn:www.agenziaentrate.gov.it:specificheTecniche:sco:730
type	DatoNP_Type
facets	Kind Value pattern [1-9]{1}[0-9]*
source	<xs:element name="AddComunaleIrpef" type="cm:DatoNP_Type" minOccurs="0"/>

element **Ritenute_Acconti_Sospesi_Type/SostitutivaProduttivita**

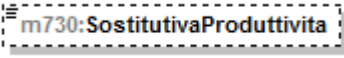
diagram	
namespace	urn:www.agenziaentrate.gov.it:specificheTecniche:sco:730
type	DatoNP_Type
facets	Kind Value pattern [1-9]{1}[0-9]*
source	<xs:element name="SostitutivaProduttivita" type="cm:DatoNP_Type" minOccurs="0"/>

element **Ritenute_Acconti_Sospesi_Type/CedolareSecca**

diagram	
---------	---

namespace	urn:www.agenziaentrate.gov.it:specificheTecniche:sco:730
type	DatoNP_Type
facets	Kind Value pattern [1-9]{1}[0-9]*
source	<xs:element name="CedolareSecca" type="cm:DatoNP_Type" minOccurs="0"/>

element Ritenute_Acconti_Sospesi_Type/ContribSolidarieta

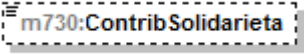
diagram	
namespace	urn:www.agenziaentrate.gov.it:specificheTecniche:sco:730
type	DatoNP_Type
facets	Kind Value pattern [1-9]{1}[0-9]*
source	<xs:element name="ContribSolidarieta" type="cm:DatoNP_Type" minOccurs="0"/>

complexType Ritenute_Lavoro_Dip_Type

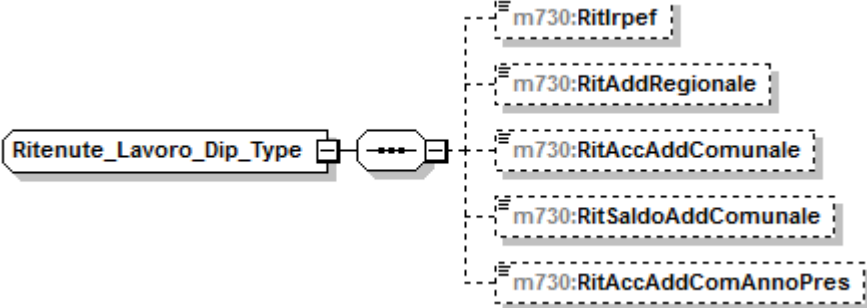
diagram	
namespace	urn:www.agenziaentrate.gov.it:specificheTecniche:sco:730
children	m730:Ritlrpef m730:RitAddRegionale m730:RitAccAddComunale m730:RitSaldoAddComunale m730:RitAccAddComAnnoPres
source	<xs:complexType name="Ritenute_Lavoro_Dip_Type"> <xs:sequence> <xs:element name="Ritlrpef" type="cm:DatoNP_Type" minOccurs="0"/> <xs:element name="RitAddRegionale" type="cm:DatoNP_Type" minOccurs="0"/> <xs:element name="RitAccAddComunale" type="cm:DatoNP_Type" minOccurs="0"/> <xs:element name="RitSaldoAddComunale" type="cm:DatoNP_Type" minOccurs="0"/> <xs:element name="RitAccAddComAnnoPres" type="cm:DatoNP_Type" minOccurs="0"/> </xs:sequence> </xs:complexType>

element Ritenute_Lavoro_Dip_Type/Ritlrpef

diagram	
namespace	urn:www.agenziaentrate.gov.it:specificheTecniche:sco:730
type	DatoNP_Type
facets	Kind Value pattern [1-9]{1}[0-9]*
source	<xs:element name="Ritlrpef" type="cm:DatoNP_Type" minOccurs="0"/>

element **Ritenute_Lavoro_Dip_Type/RitAddRegionale**

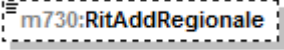
diagram	
namespace	urn:www.agenziaentrate.gov.it:specificheTecniche:sco:730
type	DatoNP_Type
facets	Kind Value pattern [1-9]{1}[0-9]*
source	<xs:element name="RitAddRegionale" type="cm:DatoNP_Type" minOccurs="0"/>

element **Ritenute_Lavoro_Dip_Type/RitAccAddComunale**

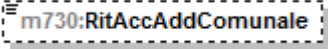
diagram	
namespace	urn:www.agenziaentrate.gov.it:specificheTecniche:sco:730
type	DatoNP_Type
facets	Kind Value pattern [1-9]{1}[0-9]*
source	<xs:element name="RitAccAddComunale" type="cm:DatoNP_Type" minOccurs="0"/>

element **Ritenute_Lavoro_Dip_Type/RitSaldoAddComunale**

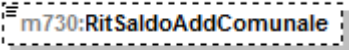
diagram	
namespace	urn:www.agenziaentrate.gov.it:specificheTecniche:sco:730
type	DatoNP_Type
facets	Kind Value pattern [1-9]{1}[0-9]*
source	<xs:element name="RitSaldoAddComunale" type="cm:DatoNP_Type" minOccurs="0"/>

element **Ritenute_Lavoro_Dip_Type/RitAccAddComAnnoPres**

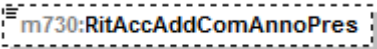
diagram	
namespace	urn:www.agenziaentrate.gov.it:specificheTecniche:sco:730
type	DatoNP_Type
facets	Kind Value pattern [1-9]{1}[0-9]*
source	<xs:element name="RitAccAddComAnnoPres" type="cm:DatoNP_Type" minOccurs="0"/>

complexType **Sezione_Altri_Redd_Type**

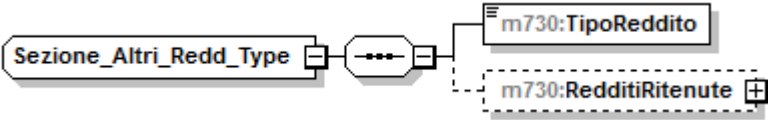
diagram	
namespace	urn:www.agenziaentrate.gov.it:specificheTecniche:sco:730
children	m730:TipoReddito m730:RedditiRitenute

source	<pre><xs:complexType name="Sezione_Altri_Redd_Type"> <xs:sequence> <xs:element name="TipoReddito" type="m730:Tipo_Reddito_Da1a8_Type"/> <xs:element name="RedditiRitenute" type="m730:Redditi_Ritenute_Type" minOccurs="0"/> </xs:sequence> </xs:complexType></pre>
--------	---

element **Sezione_Altri_Redd_Type/TipoReddito**

diagram																					
namespace	urn:www.agenziaentrate.gov.it:specificheTecniche:sco:730																				
type	m730:Tipo_Reddito_Da1a8_Type																				
facets	<table border="1"> <thead> <tr> <th>Kind</th> <th>Value</th> </tr> </thead> <tbody> <tr> <td>pattern</td> <td>[1-9]{1}[0-9]*</td> </tr> <tr> <td>enumeration</td> <td>1</td> </tr> <tr> <td>enumeration</td> <td>2</td> </tr> <tr> <td>enumeration</td> <td>3</td> </tr> <tr> <td>enumeration</td> <td>4</td> </tr> <tr> <td>enumeration</td> <td>5</td> </tr> <tr> <td>enumeration</td> <td>6</td> </tr> <tr> <td>enumeration</td> <td>7</td> </tr> <tr> <td>enumeration</td> <td>8</td> </tr> </tbody> </table>	Kind	Value	pattern	[1-9]{1}[0-9]*	enumeration	1	enumeration	2	enumeration	3	enumeration	4	enumeration	5	enumeration	6	enumeration	7	enumeration	8
Kind	Value																				
pattern	[1-9]{1}[0-9]*																				
enumeration	1																				
enumeration	2																				
enumeration	3																				
enumeration	4																				
enumeration	5																				
enumeration	6																				
enumeration	7																				
enumeration	8																				
source	<pre><xs:element name="TipoReddito" type="m730:Tipo_Reddito_Da1a8_Type"/></pre>																				

element **Sezione_Altri_Redd_Type/RedditiRitenute**

diagram	
namespace	urn:www.agenziaentrate.gov.it:specificheTecniche:sco:730
type	m730:Redditi_Ritenute_Type
children	m730:ImportoRedditi m730:ImportoRitenute
source	<pre><xs:element name="RedditiRitenute" type="m730:Redditi_Ritenute_Type" minOccurs="0"/></pre>

complexType **Sezione_Dati_Catastali_Recupero_Patrimonio_Edilizio_Type**

diagram	
namespace	urn:www.agenziaentrate.gov.it:specificheTecniche:sco:730
children	m730:DatiCatastaliRecuperoPatrimonioEdilizio m730:DatiRegistrazioneAccatastamentoRecuperoPatrimonio_Edilizio
source	<pre><xs:complexType name="Sezione_Dati_Catastali_Recupero_Patrimonio_Edilizio_Type"> <xs:sequence> <xs:element name="DatiCatastaliRecuperoPatrimonioEdilizio" minOccurs="0" maxOccurs="2"/> </xs:sequence> </xs:complexType></pre>

```

<xs:complexContent>
  <xs:extension base="m730:Dati_Catastali_Recupero_Patrimonio_Edilizio_Type"/>
</xs:complexContent>
</xs:complexType>
</xs:element>
<xs:element name="DatiRegistrazioneAccatastamentoRecuperoPatrimonio_Edilizio"
  type="m730:Dati_Registrazione_Accatastamento_Recupero_Patrimonio_Edilizio_Type" minOccurs="0"/>
</xs:sequence>
</xs:complexType>

```

element **Sezione Dati Catastali Recupero Patrimonio Edilizio Type/DatiCatastaliRecuperoPatrimonioEdilizio**

diagram	
namespace	urn:www.agenziaentrate.gov.it:specificheTecniche:sco:730
type	extension of m730:Dati Catastali Recupero Patrimonio Edilizio Type
children	m730:NOrdImmobile m730:Condominio m730:CodiceComune m730:TerreniUrbano m730:SezioneUrbanaComuneCatastale m730:Foglio m730:Particella m730:Subalterno
source	<pre> <xs:element name="DatiCatastaliRecuperoPatrimonioEdilizio" minOccurs="0" maxOccurs="2"> <xs:complexType> <xs:complexContent> <xs:extension base="m730:Dati_Catastali_Recupero_Patrimonio_Edilizio_Type"/> </xs:complexContent> </xs:complexType> </xs:element> </pre>

element

Sezione Dati Catastali Recupero Patrimonio Edilizio_Type/DatiRegistrazioneAccatastamentoRecuperoPatrimonio_Edilizio

diagram	
namespace	urn:www.agenziaentrate.gov.it:specificheTecniche:sco:730
type	m730:Dati_Registrazione_Accatastamento_Recupero_Patrimonio_Edilizio_Type
children	m730:NOrdImmobile m730:Condominio m730:EstremiRegistrazioneContratto m730:DataDomandaAccatastamento m730:NumeroDomandaAccatastamento m730:ProvinciaUfficioDomandaAccatastamento
source	<code><xs:element name="DatiRegistrazioneAccatastamentoRecuperoPatrimonio_Edilizio" type="m730:Dati_Registrazione_Accatastamento_Recupero_Patrimonio_Edilizio_Type" minOccurs="0"/></code>

complexType Soggetto_Assistenza_FiscaliDoc_type

diagram	
namespace	urn:www.agenziaentrate.gov.it:specificheTecniche:sco:730
children	m730:DataConsegna m730:TipologiaSoggettoAssFisc m730:SostitutoCF m730:DatiCafDoc m730:DatiProfessionistaDoc m730:DatiAssociazioneDoc m730:AgenziaEntrate
source	<code><xs:complexType name="Soggetto_Assistenza_FiscaliDoc_type"> <xs:sequence> <xs:element name="DataConsegna" type="cm:DatoDT_Type"/> <xs:element name="TipologiaSoggettoAssFisc" type="m730:Tipologia_Soggetto_AssFisc_Type"/> <xs:choice> <xs:element name="SostitutoCF" type="cm:DatoCF_Type"/> <xs:element name="DatiCafDoc"/> <xs:complexType> <xs:complexContent> <xs:extension base="m730:Dati_CAF_Type"> <xs:sequence> <xs:element name="CFResponsabile" type="cm:DatoCF_Type"/> <xs:element name="CognomeResponsabile" type="cm:DatoAN_Type"/> </xs:sequence> </xs:complexContent> </xs:complexType> </xs:choice> </xs:sequence> </xs:complexType></code>

element **Soggetto_Assistenza_FiscaliDoc_type/SostitutoCF**

diagram	
namespace	urn:www.agenziaentrate.gov.it:specificheTecniche:sco:730
type	DatoCF_Type
facets	Kind Value pattern [0-9]{11}[A-Z]{6}[0-9LMNPQRSTUUV]{2}[A-Z]{1}[0-9LMNPQRSTUUV]{2}[A-Z]{1}[0-9LMNPQRSTUUV]{3}[A-Z]{1}
source	<xs:element name="SostitutoCF" type="cm:DatoCF_Type"/>

element **Soggetto_Assistenza_FiscaliDoc_type/DatiCafDoc**

diagram	
namespace	urn:www.agenziaentrate.gov.it:specificheTecniche:sco:730
type	extension of m730:Dati_CAF_Type
children	m730:CFCaf m730:DenominazioneCaf m730:NumeroAlbo m730:CFResponsabile m730:CognomeResponsabile m730:NomeResponsabile
source	<xs:element name="DatiCafDoc"> <xs:complexType> <xs:complexContent> <xs:extension base="m730:Dati_CAF_Type"> <xs:sequence> <xs:element name="CFResponsabile" type="cm:DatoCF_Type"/> <xs:element name="CognomeResponsabile" type="cm:DatoAN_Type"/> <xs:element name="NomeResponsabile" type="cm:DatoAN_Type"/> </xs:sequence> </xs:extension> </xs:complexContent> </xs:complexType> </xs:element>

element **Soggetto_Assistenza_FiscaliDoc_type/DatiCafDoc/CFResponsabile**

diagram	
namespace	urn:www.agenziaentrate.gov.it:specificheTecniche:sco:730
type	DatoCF_Type
facets	Kind Value pattern [0-9]{11}[A-Z]{6}[0-9LMNPQRSTUUV]{2}[A-Z]{1}[0-9LMNPQRSTUUV]{2}[A-Z]{1}[0-9LMNPQRSTUUV]{3}[A-Z]{1}

source	<xs:element name="CFResponsabile" type="cm:DatoCF_Type"/>
--------	---

element **Soggetto_Assistenza_FiscaliDoc_type/DatiCafDoc/CognomeResponsabile**

diagram	
namespace	urn:www.agenziaentrate.gov.it:specificheTecniche:sco:730
type	DatoAN_Type
facets	Kind Value pattern ([0-9A-Z-] \"){1}([0-9A-Z&:] ' - \., / ^ \^\(\\) À É È Ì Ò Ù Û " \ \\ / +)*
source	<xs:element name="CognomeResponsabile" type="cm:DatoAN_Type"/>

element **Soggetto_Assistenza_FiscaliDoc_type/DatiCafDoc/NomeResponsabile**

diagram	
namespace	urn:www.agenziaentrate.gov.it:specificheTecniche:sco:730
type	DatoAN_Type
facets	Kind Value pattern ([0-9A-Z-] \"){1}([0-9A-Z&:] ' - \., / ^ \^\(\\) À É È Ì Ò Ù Û " \ \\ / +)*
source	<xs:element name="NomeResponsabile" type="cm:DatoAN_Type"/>

element **Soggetto_Assistenza_FiscaliDoc_type/DatiProfessionistaDoc**

diagram	
namespace	urn:www.agenziaentrate.gov.it:specificheTecniche:sco:730
type	extension of m730:Dati_Professionista_Type
children	m730:CFProfessionista m730:CognomeProfessionista m730:NomeProfessionista m730:DatiNascitaProfessionista
source	<xs:element name="DatiProfessionistaDoc"> <xs:complexType> <xs:complexContent> <xs:extension base="m730:Dati_Professionista_Type"> <xs:sequence> <xs:element name="DatiNascitaProfessionista" type="m730:Dati_Nascita_PF_Type"/> </xs:sequence> </xs:extension> </xs:complexContent> </xs:complexType> </xs:element>

element **Soggetto_Assistenza_FiscaliDoc_type/DatiProfessionistaDoc/DatiNascitaProfessionista**

diagram	
namespace	urn:www.agenziaentrate.gov.it:specificheTecniche:sco:730
type	m730:Dati_Nascita_PF_Type
children	m730:Sesso m730:DataNascita m730:ComuneNascita m730:ProvinciaNascita
source	<code><xs:element name="DatiNascitaProfessionista" type="m730:Dati_Nascita_PF_Type"/></code>

element **Soggetto_Assistenza_FiscaliDoc_type/DatiAssociazioneDoc**

diagram	
namespace	urn:www.agenziaentrate.gov.it:specificheTecniche:sco:730
type	extension of m730:Dati_Associazioni_Professionale_Type
children	m730:CFAssociazione m730:DenominazioneAssociazione m730:CFProfessionista m730:CognomeProfessionista m730:NomeProfessionista m730:DatiNascitaProfessionista
source	<pre> <xs:element name="DatiAssociazioneDoc"> <xs:complexType> <xs:complexContent> <xs:extension base="m730:Dati_Associazioni_Professionale_Type"> <xs:sequence> <xs:element name="DatiNascitaProfessionista" type="m730:Dati_Nascita_PF_Type"/> </xs:sequence> </xs:extension> </xs:complexContent> </xs:complexType> </xs:element> </pre>

element **Soggetto_Assistenza_FiscaliDoc_type/DatiAssociazioneDoc/DatiNascitaProfessionista**

diagram	
namespace	urn:www.agenziaentrate.gov.it:specificheTecniche:sco:730
type	m730:Dati_Nascita_PF_Type
children	m730:Sesso m730:DataNascita m730:ComuneNascita m730:ProvinciaNascita
source	<code><xs:element name="DatiNascitaProfessionista" type="m730:Dati_Nascita_PF_Type"/></code>

element **Soggetto_Assistenza_FiscaliDoc_type/AgenziaEntrate**

diagram	
namespace	urn:www.agenziaentrate.gov.it:specificheTecniche:sco:730
type	DatoCB_Type
facets	Kind Value pattern [01]
source	<code><xs:element name="AgenziaEntrate" type="cm:DatoCB_Type"/></code>

complexType **Soggetto_Fiscale_730_Type**

diagram	
namespace	urn:www.agenziaentrate.gov.it:specificheTecniche:sco:730
children	m730:CodiceFiscale m730:Email m730:Telefono m730:Cellulare
source	<pre> <xs:complexType name="Soggetto_Fiscale_730_Type"> <xs:sequence> <xs:element name="CodiceFiscale" type="cm:DatoCF_Type"/> <xs:element name="Email" type="cm:DatoEM_Type" minOccurs="0"/> <xs:element name="Telefono" type="cm:DatoAN_Type" minOccurs="0"/> <xs:element name="Cellulare" type="cm:DatoAN_Type" minOccurs="0"/> </xs:sequence> </xs:complexType> </pre>

element **Soggetto_Fiscale_730_Type/CodiceFiscale**

diagram	
namespace	urn:www.agenziaentrate.gov.it:specificheTecniche:sco:730
type	DatoCF_Type
facets	Kind Value pattern [0-9]{11}[A-Z]{6}[0-9LMNPQRSTUVWXYZ]{2}[A-Z]{1}[0-9LMNPQRSTUVWXYZ]{2}[A-Z]{1}[0-9LMNPQRSTUVWXYZ]{3}[A-Z]{1}
source	<xs:element name="CodiceFiscale" type="cm:DatoCF_Type"/>

element **Soggetto_Fiscale_730_Type/Email**

diagram	
namespace	urn:www.agenziaentrate.gov.it:specificheTecniche:sco:730
type	DatoEM_Type
facets	Kind Value pattern [a-zA-Z0-9._%!\"?^~=]+@[a-zA-Z0-9.\-]+\.[a-zA-Z]{2,4}
source	<xs:element name="Email" type="cm:DatoEM_Type" minOccurs="0"/>

element **Soggetto_Fiscale_730_Type/Telefono**

diagram	
namespace	urn:www.agenziaentrate.gov.it:specificheTecniche:sco:730
type	DatoAN_Type
facets	Kind Value pattern (([0-9A-Z-] \"){1}([0-9A-Z&] '\- \., / \° \^\(\ \)\À È É Ì Ò Ù Û " \ \\ \ +)*
source	<xs:element name="Telefono" type="cm:DatoAN_Type" minOccurs="0"/>

element **Soggetto_Fiscale_730_Type/Cellulare**

diagram	
namespace	urn:www.agenziaentrate.gov.it:specificheTecniche:sco:730
type	DatoAN_Type
facets	Kind Value pattern (([0-9A-Z-] \"){1}([0-9A-Z&] '\- \., / \° \^\(\ \)\À È É Ì Ò Ù Û " \ \\ \ +)*
source	<xs:element name="Cellulare" type="cm:DatoAN_Type" minOccurs="0"/>

complexType **Soglie_Esenzione_Type**

diagram	
namespace	urn:www.agenziaentrate.gov.it:specificheTecniche:sco:730
children	m730:SogliaEsenzione m730:EsenzioneTotale

source	<pre> <xs:complexType name="Soglie_Esenzione_Type"> <xs:choice> <xs:element name="SogliaEsenzione" type="cm:DatoNP_Type" minOccurs="0"/> <xs:element name="EsenzioneTotale" minOccurs="0"> <xs:simpleType> <xs:restriction base="cm:DatoN1_Type"> <xs:enumeration value="1"/> <xs:enumeration value="2"/> </xs:restriction> </xs:simpleType> </xs:element> </xs:choice> </xs:complexType> </pre>
--------	--

element **Soglie_Esenzione_Type/SogliaEsenzione**

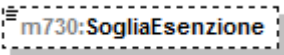
diagram					
namespace	urn:www.agenziaentrate.gov.it:specificheTecniche:sco:730				
type	DatoNP_Type				
facets	<table border="1"> <thead> <tr> <th>Kind</th> <th>Value</th> </tr> </thead> <tbody> <tr> <td>pattern</td> <td>[1-9]{1}[0-9]*</td> </tr> </tbody> </table>	Kind	Value	pattern	[1-9]{1}[0-9]*
Kind	Value				
pattern	[1-9]{1}[0-9]*				
source	<pre><xs:element name="SogliaEsenzione" type="cm:DatoNP_Type" minOccurs="0"/></pre>				

element **Soglie_Esenzione_Type/EsenzioneTotale**

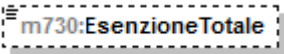
diagram									
namespace	urn:www.agenziaentrate.gov.it:specificheTecniche:sco:730								
type	restriction of DatoN1_Type								
facets	<table border="1"> <thead> <tr> <th>Kind</th> <th>Value</th> </tr> </thead> <tbody> <tr> <td>pattern</td> <td>[1-9]</td> </tr> <tr> <td>enumeration</td> <td>1</td> </tr> <tr> <td>enumeration</td> <td>2</td> </tr> </tbody> </table>	Kind	Value	pattern	[1-9]	enumeration	1	enumeration	2
Kind	Value								
pattern	[1-9]								
enumeration	1								
enumeration	2								
source	<pre> <xs:element name="EsenzioneTotale" minOccurs="0"> <xs:simpleType> <xs:restriction base="cm:DatoN1_Type"> <xs:enumeration value="1"/> <xs:enumeration value="2"/> </xs:restriction> </xs:simpleType> </xs:element> </pre>								

complexType **Sostituto_Type**

diagram	
namespace	urn:www.agenziaentrate.gov.it:specificheTecniche:sco:730
children	m730:CodiceFiscale m730:DatiAnagraficiPF m730:DenominazionePNF m730:Residenza m730:Fax m730:CodiceSede
source	<pre> <xs:complexType name="Sostituto_Type"> <xs:sequence> <xs:element name="CodiceFiscale" type="cm:DatoCF_Type" minOccurs="0"/> <xs:choice> <xs:element name="DatiAnagraficiPF" minOccurs="0"> <xs:complexType> <xs:sequence> <xs:element name="Cognome" type="cm:DatoAN_Type" minOccurs="0"/> <xs:element name="Nome" type="cm:DatoAN_Type" minOccurs="0"/> </xs:sequence> </xs:complexType> </xs:element> <xs:element name="DenominazionePNF" type="cm:DatoAN_Type" minOccurs="0"/> </xs:choice> <xs:element name="Residenza" type="m730:Residenza_Type" minOccurs="0"/> <xs:element name="Fax" type="cm:DatoAN_Type" minOccurs="0"/> <xs:element name="CodiceSede" type="cm:DatoAN_Type" minOccurs="0"/> </xs:sequence> </xs:complexType> </pre>

element **Sostituto_Type/CodiceFiscale**

diagram					
namespace	urn:www.agenziaentrate.gov.it:specificheTecniche:sco:730				
type	DatoCF_Type				
facets	<table border="1"> <thead> <tr> <th>Kind</th> <th>Value</th> </tr> </thead> <tbody> <tr> <td>pattern</td> <td>[0-9]{1}[A-Z]{6}[0-9LMNPQRSTUVWXYZ]{2}[A-Z]{1}[0-9LMNPQRSTUVWXYZ]{2}[A-Z]{1}[0-9LMNPQRSTUVWXYZ]{3}[A-Z]{1}</td> </tr> </tbody> </table>	Kind	Value	pattern	[0-9]{1}[A-Z]{6}[0-9LMNPQRSTUVWXYZ]{2}[A-Z]{1}[0-9LMNPQRSTUVWXYZ]{2}[A-Z]{1}[0-9LMNPQRSTUVWXYZ]{3}[A-Z]{1}
Kind	Value				
pattern	[0-9]{1}[A-Z]{6}[0-9LMNPQRSTUVWXYZ]{2}[A-Z]{1}[0-9LMNPQRSTUVWXYZ]{2}[A-Z]{1}[0-9LMNPQRSTUVWXYZ]{3}[A-Z]{1}				
source	<pre><xs:element name="CodiceFiscale" type="cm:DatoCF_Type" minOccurs="0"/></pre>				

element **Sostituto_Type/DatiAnagraficiPF**

diagram	
namespace	urn:www.agenziaentrate.gov.it:specificheTecniche:sco:730

children	m730:Cognome m730:Nome
source	<pre><xs:element name="DatiAnagraficiPF" minOccurs="0"> <xs:complexType> <xs:sequence> <xs:element name="Cognome" type="cm:DatoAN_Type" minOccurs="0"/> <xs:element name="Nome" type="cm:DatoAN_Type" minOccurs="0"/> </xs:sequence> </xs:complexType> </xs:element></pre>

element **Sostituto_Type/DatiAnagraficiPF/Cognome**

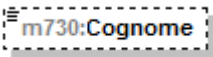
diagram					
namespace	urn:www.agenziaentrate.gov.it:specificheTecniche:sco:730				
type	DatoAN_Type				
facets	<table border="1"> <thead> <tr> <th>Kind</th> <th>Value</th> </tr> </thead> <tbody> <tr> <td>pattern</td> <td>([0-9A-Z\-\]]&quot;){1}([0-9A-Z&amp;:] \- \., / ^ \^\(\ \)\ À É È Ì Ò Ù Ú Û&quot; \ \ \ /+)*</td> </tr> </tbody> </table>	Kind	Value	pattern	([0-9A-Z\-\]]"){1}([0-9A-Z&:] \- \., / ^ \^\(\ \)\ À É È Ì Ò Ù Ú Û" \ \ \ /+)*
Kind	Value				
pattern	([0-9A-Z\-\]]"){1}([0-9A-Z&:] \- \., / ^ \^\(\ \)\ À É È Ì Ò Ù Ú Û" \ \ \ /+)*				
source	<pre><xs:element name="Cognome" type="cm:DatoAN_Type" minOccurs="0"/></pre>				

element **Sostituto_Type/DatiAnagraficiPF/Nome**

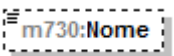
diagram					
namespace	urn:www.agenziaentrate.gov.it:specificheTecniche:sco:730				
type	DatoAN_Type				
facets	<table border="1"> <thead> <tr> <th>Kind</th> <th>Value</th> </tr> </thead> <tbody> <tr> <td>pattern</td> <td>([0-9A-Z\-\]]&quot;){1}([0-9A-Z&amp;:] \- \., / ^ \^\(\ \)\ À É È Ì Ò Ù Ú Û&quot; \ \ \ /+)*</td> </tr> </tbody> </table>	Kind	Value	pattern	([0-9A-Z\-\]]"){1}([0-9A-Z&:] \- \., / ^ \^\(\ \)\ À É È Ì Ò Ù Ú Û" \ \ \ /+)*
Kind	Value				
pattern	([0-9A-Z\-\]]"){1}([0-9A-Z&:] \- \., / ^ \^\(\ \)\ À É È Ì Ò Ù Ú Û" \ \ \ /+)*				
source	<pre><xs:element name="Nome" type="cm:DatoAN_Type" minOccurs="0"/></pre>				

element **Sostituto_Type/DenominazionePNF**

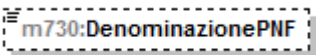
diagram					
namespace	urn:www.agenziaentrate.gov.it:specificheTecniche:sco:730				
type	DatoAN_Type				
facets	<table border="1"> <thead> <tr> <th>Kind</th> <th>Value</th> </tr> </thead> <tbody> <tr> <td>pattern</td> <td>([0-9A-Z\-\]]&quot;){1}([0-9A-Z&amp;:] \- \., / ^ \^\(\ \)\ À É È Ì Ò Ù Ú Û&quot; \ \ \ /+)*</td> </tr> </tbody> </table>	Kind	Value	pattern	([0-9A-Z\-\]]"){1}([0-9A-Z&:] \- \., / ^ \^\(\ \)\ À É È Ì Ò Ù Ú Û" \ \ \ /+)*
Kind	Value				
pattern	([0-9A-Z\-\]]"){1}([0-9A-Z&:] \- \., / ^ \^\(\ \)\ À É È Ì Ò Ù Ú Û" \ \ \ /+)*				
source	<pre><xs:element name="DenominazionePNF" type="cm:DatoAN_Type" minOccurs="0"/></pre>				

element **Sostituto_Type/Residenza**

diagram	
namespace	urn:www.agenziaentrate.gov.it:specificheTecniche:sco:730
type	m730:Residenza_Type
children	m730:Comune m730:Provincia m730:CodiceComune m730:Cap m730:Tipologia m730:Indirizzo m730:NumCivico m730:Frazione m730:Email m730:Telefono
source	<code><xs:element name="Residenza" type="m730:Residenza_Type" minOccurs="0"/></code>

element **Sostituto_Type/Fax**

diagram					
namespace	urn:www.agenziaentrate.gov.it:specificheTecniche:sco:730				
type	DatoAN_Type				
facets	<table border="0"> <tr> <td>Kind</td> <td>Value</td> </tr> <tr> <td>pattern</td> <td>(([0-9A-Z-] \&quot;){1}([0-9A-Z&amp;:] \- \., / \^\(\ \)\ À È É Ì Ò Ù Û &quot; \ \\ \+)*</td> </tr> </table>	Kind	Value	pattern	(([0-9A-Z-] \"){1}([0-9A-Z&:] \- \., / \^\(\ \)\ À È É Ì Ò Ù Û " \ \\ \+)*
Kind	Value				
pattern	(([0-9A-Z-] \"){1}([0-9A-Z&:] \- \., / \^\(\ \)\ À È É Ì Ò Ù Û " \ \\ \+)*				
source	<code><xs:element name="Fax" type="cm:DatoAN_Type" minOccurs="0"/></code>				

element **Sostituto_Type/CodiceSede**

diagram					
namespace	urn:www.agenziaentrate.gov.it:specificheTecniche:sco:730				
type	DatoAN_Type				
facets	<table border="0"> <tr> <td>Kind</td> <td>Value</td> </tr> <tr> <td>pattern</td> <td>(([0-9A-Z-] \&quot;){1}([0-9A-Z&amp;:] \- \., / \^\(\ \)\ À È É Ì Ò Ù Û &quot; \ \\ \+)*</td> </tr> </table>	Kind	Value	pattern	(([0-9A-Z-] \"){1}([0-9A-Z&:] \- \., / \^\(\ \)\ À È É Ì Ò Ù Û " \ \\ \+)*
Kind	Value				
pattern	(([0-9A-Z-] \"){1}([0-9A-Z&:] \- \., / \^\(\ \)\ À È É Ì Ò Ù Û " \ \\ \+)*				
source	<code><xs:element name="CodiceSede" type="cm:DatoAN_Type" minOccurs="0"/></code>				

complexType **Spese_Arredo_Type**

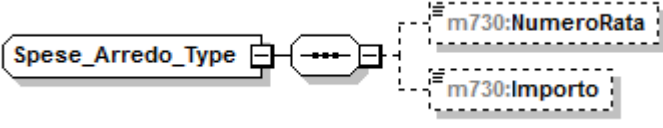
diagram	
namespace	urn:www.agenziaentrate.gov.it:specificheTecniche:sco:730
children	m730:NumeroRata m730:Importo
source	<pre><xs:complexType name="Spese_Arredo_Type"> <xs:sequence> <xs:element name="NumeroRata" type="m730:Numero_RateDa1A2_Type" minOccurs="0"/> <xs:element name="Importo" type="cm:DatoNP_Type" minOccurs="0"/> </xs:sequence> </xs:complexType></pre>

element **Spese_Arredo_Type/NumeroRata**

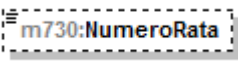
diagram									
namespace	urn:www.agenziaentrate.gov.it:specificheTecniche:sco:730								
type	m730:Numero_RateDa1A2_Type								
facets	<table border="1"> <thead> <tr> <th>Kind</th> <th>Value</th> </tr> </thead> <tbody> <tr> <td>pattern</td> <td>[1-9]</td> </tr> <tr> <td>enumeration</td> <td>1</td> </tr> <tr> <td>enumeration</td> <td>2</td> </tr> </tbody> </table>	Kind	Value	pattern	[1-9]	enumeration	1	enumeration	2
Kind	Value								
pattern	[1-9]								
enumeration	1								
enumeration	2								
source	<pre><xs:element name="NumeroRata" type="m730:Numero_RateDa1A2_Type" minOccurs="0"/></pre>								

element **Spese_Arredo_Type/Importo**

diagram					
namespace	urn:www.agenziaentrate.gov.it:specificheTecniche:sco:730				
type	DatoNP_Type				
facets	<table border="1"> <thead> <tr> <th>Kind</th> <th>Value</th> </tr> </thead> <tbody> <tr> <td>pattern</td> <td>[1-9]{1}[0-9]*</td> </tr> </tbody> </table>	Kind	Value	pattern	[1-9]{1}[0-9]*
Kind	Value				
pattern	[1-9]{1}[0-9]*				
source	<pre><xs:element name="Importo" type="cm:DatoNP_Type" minOccurs="0"/></pre>				

complexType **Spese_Rateizzate_Anni_Precedenti_Type**

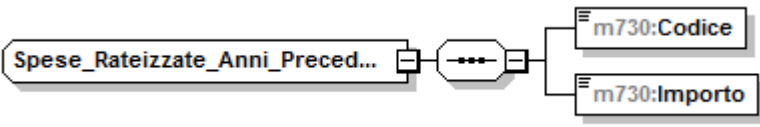
diagram	
namespace	urn:www.agenziaentrate.gov.it:specificheTecniche:sco:730
children	m730:Codice m730:Importo
source	<pre><xs:complexType name="Spese_Rateizzate_Anni_Precedenti_Type"> <xs:sequence> <xs:element name="Codice" type="m730:Codice_Spese_Rateizzate_Anni_Precedenti_Type"/> <xs:element name="Importo" type="cm:DatoNP_Type"/> </xs:sequence> </xs:complexType></pre>

	<code></xs:complexType></code>
--	--------------------------------------

element **Spese_Rateizzate_Anni_Precedenti_Type/Codice**

diagram											
namespace	urn:www.agenziaentrate.gov.it:specificheTecniche:sco:730										
type	m730:Codice Spese_Rateizzate_Anni_Precedenti_Type										
facets	<table border="1"><thead><tr><th>Kind</th><th>Value</th></tr></thead><tbody><tr><td>pattern</td><td>[1-9]{1}[0-9]*</td></tr><tr><td>enumeration</td><td>2</td></tr><tr><td>enumeration</td><td>3</td></tr><tr><td>enumeration</td><td>4</td></tr></tbody></table>	Kind	Value	pattern	[1-9]{1}[0-9]*	enumeration	2	enumeration	3	enumeration	4
Kind	Value										
pattern	[1-9]{1}[0-9]*										
enumeration	2										
enumeration	3										
enumeration	4										
source	<code><xs:element name="Codice" type="m730:Codice_Spese_Rateizzate_Anni_Precedenti_Type"/></code>										

element **Spese_Rateizzate_Anni_Precedenti_Type/Importo**

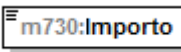
diagram					
namespace	urn:www.agenziaentrate.gov.it:specificheTecniche:sco:730				
type	DatoNP_Type				
facets	<table border="1"><thead><tr><th>Kind</th><th>Value</th></tr></thead><tbody><tr><td>pattern</td><td>[1-9]{1}[0-9]*</td></tr></tbody></table>	Kind	Value	pattern	[1-9]{1}[0-9]*
Kind	Value				
pattern	[1-9]{1}[0-9]*				
source	<code><xs:element name="Importo" type="cm:DatoNP_Type"/></code>				

complexType **Spese_Rateizzate_Type**

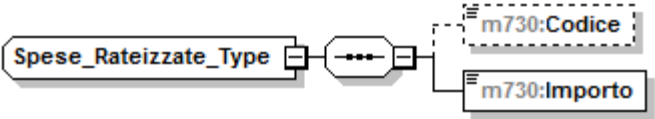
diagram	
namespace	urn:www.agenziaentrate.gov.it:specificheTecniche:sco:730
children	m730:Codice m730:Importo
source	<pre><xs:complexType name="Spese_Rateizzate_Type"> <xs:sequence> <xs:element name="Codice" type="m730:Codice_Spese_Rateizzate_Type" minOccurs="0"/> <xs:element name="Importo" type="cm:DatoNP_Type"/> </xs:sequence> </xs:complexType></pre>

element **Spese_Rateizzate_Type/Codice**

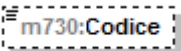
diagram													
namespace	urn:www.agenziaentrate.gov.it:specificheTecniche:sco:730												
type	m730:Codice Spese_Rateizzate_Type												
facets	<table border="1"><thead><tr><th>Kind</th><th>Value</th></tr></thead><tbody><tr><td>pattern</td><td>[1-9]{1}[0-9]*</td></tr><tr><td>enumeration</td><td>1</td></tr><tr><td>enumeration</td><td>2</td></tr><tr><td>enumeration</td><td>3</td></tr><tr><td>enumeration</td><td>4</td></tr></tbody></table>	Kind	Value	pattern	[1-9]{1}[0-9]*	enumeration	1	enumeration	2	enumeration	3	enumeration	4
Kind	Value												
pattern	[1-9]{1}[0-9]*												
enumeration	1												
enumeration	2												
enumeration	3												
enumeration	4												

source	<code><xs:element name="Codice" type="m730:Codice_Spese_Rateizzate_Type" minOccurs="0"/></code>
--------	---

element **Spese_Rateizzate_Type/Importo**

diagram					
namespace	urn:www.agenziaentrate.gov.it:specificheTecniche:sco:730				
type	DatoNP_Type				
facets	<table border="1"> <tr> <th>Kind</th> <th>Value</th> </tr> <tr> <td>pattern</td> <td>[1-9]{1}[0-9]*</td> </tr> </table>	Kind	Value	pattern	[1-9]{1}[0-9]*
Kind	Value				
pattern	[1-9]{1}[0-9]*				
source	<code><xs:element name="Importo" type="cm:DatoNP_Type"/></code>				

complexType **Tassazione_Separata_Type**

diagram	
namespace	urn:www.agenziaentrate.gov.it:specificheTecniche:sco:730
children	m730:Opzione m730:Anno m730:RedditoRitenute
source	<pre> <xs:complexType name="Tassazione_Separata_Type"> <xs:sequence> <xs:element name="Opzione" type="cm:DatoCB_Type" minOccurs="0"/> <xs:element name="Anno" type="cm:DatoDA_Type"/> <xs:element name="RedditoRitenute" type="m730:Redditi_Ritenute_Type" minOccurs="0"/> </xs:sequence> </xs:complexType> </pre>

element **Tassazione_Separata_Type/Opzione**

diagram					
namespace	urn:www.agenziaentrate.gov.it:specificheTecniche:sco:730				
type	DatoCB_Type				
facets	<table border="1"> <tr> <th>Kind</th> <th>Value</th> </tr> <tr> <td>pattern</td> <td>[01]</td> </tr> </table>	Kind	Value	pattern	[01]
Kind	Value				
pattern	[01]				
source	<code><xs:element name="Opzione" type="cm:DatoCB_Type" minOccurs="0"/></code>				

element **Tassazione_Separata_Type/Anno**

diagram					
namespace	urn:www.agenziaentrate.gov.it:specificheTecniche:sco:730				
type	DatoDA_Type				
facets	<table border="1"> <tr> <th>Kind</th> <th>Value</th> </tr> <tr> <td>pattern</td> <td>(18 19 20)[0-9]{2}</td> </tr> </table>	Kind	Value	pattern	(18 19 20)[0-9]{2}
Kind	Value				
pattern	(18 19 20)[0-9]{2}				
source	<code><xs:element name="Anno" type="cm:DatoDA_Type"/></code>				

element **Tassazione_Separata_Type/RedditoRitenute**

diagram	
namespace	urn:www.agenziaentrate.gov.it:specificheTecniche:sco:730
type	m730:Redditi_Ritenute_Type
children	m730:ImportoRedditi m730:ImportoRitenute
source	<code><xs:element name="RedditoRitenute" type="m730:Redditi_Ritenute_Type" minOccurs="0"/></code>

complexType **Terreno_Type**

diagram	
namespace	urn:www.agenziaentrate.gov.it:specificheTecniche:sco:730
children	m730:RedDominicale m730:Titolo m730:RedAgrario m730:GiorniPossesso m730:PercPossesso m730:CanoneVincolistico m730:CasiParticolari m730:CasellaContinuazione m730:CasellalmuNonDovuta m730:CasellaColtivatoreDiretto
source	<pre> <xs:complexType name="Terreno_Type"> <xs:sequence> <xs:element name="RedDominicale" type="cm:DatoNP_Type" minOccurs="0"/> <xs:element name="Titolo" type="m730:TitoloTerreno_Type"/> <xs:element name="RedAgrario" type="cm:DatoNP_Type" minOccurs="0"/> <xs:element name="GiorniPossesso" type="cm:DatoGA_Type" minOccurs="0"/> <xs:element name="PercPossesso" type="cm:DatoPC_Type" minOccurs="0"/> <xs:element name="CanoneVincolistico" type="cm:DatoNP_Type" minOccurs="0"/> <xs:element name="CasiParticolari" type="m730:CasiParticolariTerreni_Type" minOccurs="0"/> <xs:element name="CasellaContinuazione" type="cm:DatoCB_Type" minOccurs="0"/> <xs:element name="CasellalmuNonDovuta" minOccurs="0"/> </xs:sequence> <xs:simpleType> <xs:restriction base="cm:DatoN1_Type"> </pre>

	<pre> <xs:enumeration value="1"/> <xs:enumeration value="2"/> <xs:enumeration value="3"/> </xs:restriction> </xs:simpleType> </xs:element> <xs:element name="CasellaColtivatoreDiretto" type="cm:DatoCB_Type" minOccurs="0"/> </xs:sequence> </xs:complexType> </pre>
--	---

element **Terreno_Type/RedDominicale**

diagram					
namespace	urn:www.agenziaentrate.gov.it:specificheTecniche:sco:730				
type	DatoNP_Type				
facets	<table border="1"> <thead> <tr> <th>Kind</th> <th>Value</th> </tr> </thead> <tbody> <tr> <td>pattern</td> <td>[1-9]{1}[0-9]*</td> </tr> </tbody> </table>	Kind	Value	pattern	[1-9]{1}[0-9]*
Kind	Value				
pattern	[1-9]{1}[0-9]*				
source	<pre><xs:element name="RedDominicale" type="cm:DatoNP_Type" minOccurs="0"/></pre>				

element **Terreno_Type/Titolo**

diagram																					
namespace	urn:www.agenziaentrate.gov.it:specificheTecniche:sco:730																				
type	m730:TitoloTerreno_Type																				
facets	<table border="1"> <thead> <tr> <th>Kind</th> <th>Value</th> </tr> </thead> <tbody> <tr> <td>pattern</td> <td>[1-9]{1}[0-9]*</td> </tr> <tr> <td>enumeration</td> <td>1</td> </tr> <tr> <td>enumeration</td> <td>2</td> </tr> <tr> <td>enumeration</td> <td>3</td> </tr> <tr> <td>enumeration</td> <td>4</td> </tr> <tr> <td>enumeration</td> <td>5</td> </tr> <tr> <td>enumeration</td> <td>6</td> </tr> <tr> <td>enumeration</td> <td>7</td> </tr> <tr> <td>enumeration</td> <td>10</td> </tr> </tbody> </table>	Kind	Value	pattern	[1-9]{1}[0-9]*	enumeration	1	enumeration	2	enumeration	3	enumeration	4	enumeration	5	enumeration	6	enumeration	7	enumeration	10
Kind	Value																				
pattern	[1-9]{1}[0-9]*																				
enumeration	1																				
enumeration	2																				
enumeration	3																				
enumeration	4																				
enumeration	5																				
enumeration	6																				
enumeration	7																				
enumeration	10																				
source	<pre><xs:element name="Titolo" type="m730:TitoloTerreno_Type"/></pre>																				

element **Terreno_Type/RedAgrario**

diagram					
namespace	urn:www.agenziaentrate.gov.it:specificheTecniche:sco:730				
type	DatoNP_Type				
facets	<table border="1"> <thead> <tr> <th>Kind</th> <th>Value</th> </tr> </thead> <tbody> <tr> <td>pattern</td> <td>[1-9]{1}[0-9]*</td> </tr> </tbody> </table>	Kind	Value	pattern	[1-9]{1}[0-9]*
Kind	Value				
pattern	[1-9]{1}[0-9]*				
source	<pre><xs:element name="RedAgrario" type="cm:DatoNP_Type" minOccurs="0"/></pre>				

element **Terreno_Type/GiorniPossesso**

diagram	
namespace	urn:www.agenziaentrate.gov.it:specificheTecniche:sco:730

type	DatoGA_Type
facets	Kind Value pattern [1-9]{1}([0-9]{1}){1}([12][0-9]{1}){1}([3][0-5]{1}){1}([36][0-5]{1})
source	<xs:element name="GiorniPossesso" type="cm:DatoGA_Type" minOccurs="0"/>

element Terreno_Type/PercPossesso

diagram	
namespace	urn:www.agenziaentrate.gov.it:specificheTecniche:sco:730
type	DatoPC_Type
facets	Kind Value pattern [0-9]?[0-9](,\d{1,3})? 100,0{1,3}?
source	<xs:element name="PercPossesso" type="cm:DatoPC_Type" minOccurs="0"/>

element Terreno_Type/CanoneVincolistico

diagram	
namespace	urn:www.agenziaentrate.gov.it:specificheTecniche:sco:730
type	DatoNP_Type
facets	Kind Value pattern [1-9]{1}[0-9]*
source	<xs:element name="CanoneVincolistico" type="cm:DatoNP_Type" minOccurs="0"/>

element Terreno_Type/CasiParticolari

diagram	
namespace	urn:www.agenziaentrate.gov.it:specificheTecniche:sco:730
type	m730:CasiParticolariTerreni_Type
facets	Kind Value pattern [1-9] enumeration 2 enumeration 3 enumeration 4 enumeration 6
source	<xs:element name="CasiParticolari" type="m730:CasiParticolariTerreni_Type" minOccurs="0"/>

element Terreno_Type/CasellaContinuazione

diagram	
namespace	urn:www.agenziaentrate.gov.it:specificheTecniche:sco:730
type	DatoCB_Type
facets	Kind Value pattern [01]
source	<xs:element name="CasellaContinuazione" type="cm:DatoCB_Type" minOccurs="0"/>

element **Terreno_Type/CasellalmuNonDovuta**

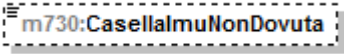
diagram					
namespace	urn:www.agenziaentrate.gov.it:specificheTecniche:sco:730				
type	DatoCB_Type				
facets	<table border="1"> <tr> <td>Kind</td> <td>Value</td> </tr> <tr> <td>pattern</td> <td>[01]</td> </tr> </table>	Kind	Value	pattern	[01]
Kind	Value				
pattern	[01]				
source	<code><xs:element name="CasellalmuNonDovuta" type="cm:DatoCB_Type" minOccurs="0"/></code>				

element **Terreno_Type/CasellaColtivatoreDiretto**

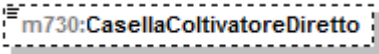
diagram					
namespace	urn:www.agenziaentrate.gov.it:specificheTecniche:sco:730				
type	<u>DatoCB_Type</u>				
facets	<table border="1"> <tr> <td>Kind</td> <td>Value</td> </tr> <tr> <td>pattern</td> <td>[01]</td> </tr> </table>	Kind	Value	pattern	[01]
Kind	Value				
pattern	[01]				
source	<code><xs:element name="CasellaColtivatoreDiretto" type="cm:DatoCB_Type" minOccurs="0"/></code>				

complexType **Versamenti_F24_Type**

<p>diagram</p>	
<p>namespace</p>	<p>urn:www.agenziaentrate.gov.it:specificheTecniche:sco:730</p>
<p>children</p>	<p>m730:F24DebitoIrpef m730:F24DebitoCodRegione m730:F24DebitoAddReg m730:F24DebitoCodComune m730:F24DebitoAddCom m730:F24DebitoPrimaRataAcclrpef m730:F24DebitoAccontoTassSep m730:F24DebitoCodComuneAcconto m730:F24DebitoAccontoAddCom m730:F24DebitoImpSostProdut m730:F24DebitoCedolare m730:F24DebitoPrimaRataAccCedolare m730:F24DebitoContribSolidarieta m730:F24DebitoCodRegioneConiuge m730:F24DebitoAddRegConiuge m730:F24DebitoCodComuneConiuge m730:F24DebitoAddComConiuge m730:F24DebitoCodComuneAccConiuge m730:F24DebitoAccontoAddComConiuge m730:F24DebitoSecondaRataAcclrpef m730:F24DebitoSecondaRataAccCedolare</p>

source	<pre> <xs:complexType name="Versamenti_F24_Type"> <xs:sequence> <xs:element name="F24DebitoIrpef" type="cm:DatoNP_Type" minOccurs="0"/> <xs:element name="F24DebitoCodRegione" type="sc:Codice_Regione_Type" minOccurs="0"/> <xs:element name="F24DebitoAddReg" type="cm:DatoNP_Type" minOccurs="0"/> <xs:element name="F24DebitoCodComune" type="cm:DatoAN_Type" minOccurs="0"/> <xs:element name="F24DebitoAddCom" type="cm:DatoNP_Type" minOccurs="0"/> <xs:element name="F24DebitoPrimaRataAcclrpef" type="cm:DatoNP_Type" minOccurs="0"/> <xs:element name="F24DebitoAccontoTassSep" type="cm:DatoNP_Type" minOccurs="0"/> <xs:element name="F24DebitoCodComuneAcconto" type="cm:DatoAN_Type" minOccurs="0"/> <xs:element name="F24DebitoAccontoAddCom" type="cm:DatoNP_Type" minOccurs="0"/> <xs:element name="F24DebitoImpSostProdut" type="cm:DatoNP_Type" minOccurs="0"/> <xs:element name="F24DebitoCedolare" type="cm:DatoNP_Type" minOccurs="0"/> <xs:element name="F24DebitoPrimaRataAccCedolare" type="cm:DatoNP_Type" minOccurs="0"/> <xs:element name="F24DebitoContribSolidarieta" type="cm:DatoNP_Type" minOccurs="0"/> <xs:element name="F24DebitoCodRegioneConiuge" type="sc:Codice_Regione_Type" minOccurs="0"/> <xs:element name="F24DebitoAddRegConiuge" type="cm:DatoNP_Type" minOccurs="0"/> <xs:element name="F24DebitoCodComuneConiuge" type="cm:DatoAN_Type" minOccurs="0"/> <xs:element name="F24DebitoAddComConiuge" type="cm:DatoNP_Type" minOccurs="0"/> <xs:element name="F24DebitoCodComuneAccontoConiuge" type="cm:DatoAN_Type" minOccurs="0"/> <xs:element name="F24DebitoAccontoAddComConiuge" type="cm:DatoNP_Type" minOccurs="0"/> <xs:element name="F24DebitoSecondaRataAcclrpef" type="cm:DatoNP_Type" minOccurs="0"/> <xs:element name="F24DebitoSecondaRataAccCedolare" type="cm:DatoNP_Type" minOccurs="0"/> </xs:sequence> </xs:complexType> </pre>
--------	--

element **Versamenti_F24_Type/F24DebitoIrpef**

diagram					
namespace	urn:www.agenziaentrate.gov.it:specificheTecniche:sco:730				
type	DatoNP_Type				
facets	<table border="1"> <thead> <tr> <th>Kind</th> <th>Value</th> </tr> </thead> <tbody> <tr> <td>pattern</td> <td>[1-9]{1}[0-9]*</td> </tr> </tbody> </table>	Kind	Value	pattern	[1-9]{1}[0-9]*
Kind	Value				
pattern	[1-9]{1}[0-9]*				
source	<pre><xs:element name="F24DebitoIrpef" type="cm:DatoNP_Type" minOccurs="0"/></pre>				

element **Versamenti_F24_Type/F24DebitoCodRegione**

diagram																																							
namespace	urn:www.agenziaentrate.gov.it:specificheTecniche:sco:730																																						
type	Codice_Regione_Type																																						
facets	<table border="1"> <thead> <tr> <th>Kind</th> <th>Value</th> </tr> </thead> <tbody> <tr> <td>pattern</td> <td>{([0-9A-Z-])&quot;}{1}([0-9A-Z&amp;:] [-\., /°\^\\(\) À É È Ì Ò Ù Û &quot; \\ / +)*</td> </tr> <tr> <td>enumeration</td> <td>1</td> </tr> <tr> <td>enumeration</td> <td>2</td> </tr> <tr> <td>enumeration</td> <td>3</td> </tr> <tr> <td>enumeration</td> <td>4</td> </tr> <tr> <td>enumeration</td> <td>5</td> </tr> <tr> <td>enumeration</td> <td>6</td> </tr> <tr> <td>enumeration</td> <td>7</td> </tr> <tr> <td>enumeration</td> <td>8</td> </tr> <tr> <td>enumeration</td> <td>9</td> </tr> <tr> <td>enumeration</td> <td>10</td> </tr> <tr> <td>enumeration</td> <td>11</td> </tr> <tr> <td>enumeration</td> <td>12</td> </tr> <tr> <td>enumeration</td> <td>13</td> </tr> <tr> <td>enumeration</td> <td>14</td> </tr> <tr> <td>enumeration</td> <td>15</td> </tr> <tr> <td>enumeration</td> <td>16</td> </tr> <tr> <td>enumeration</td> <td>17</td> </tr> </tbody> </table>	Kind	Value	pattern	{([0-9A-Z-])"}{1}([0-9A-Z&:] [-\., /°\^\\(\) À É È Ì Ò Ù Û " \\ / +)*	enumeration	1	enumeration	2	enumeration	3	enumeration	4	enumeration	5	enumeration	6	enumeration	7	enumeration	8	enumeration	9	enumeration	10	enumeration	11	enumeration	12	enumeration	13	enumeration	14	enumeration	15	enumeration	16	enumeration	17
Kind	Value																																						
pattern	{([0-9A-Z-])"}{1}([0-9A-Z&:] [-\., /°\^\\(\) À É È Ì Ò Ù Û " \\ / +)*																																						
enumeration	1																																						
enumeration	2																																						
enumeration	3																																						
enumeration	4																																						
enumeration	5																																						
enumeration	6																																						
enumeration	7																																						
enumeration	8																																						
enumeration	9																																						
enumeration	10																																						
enumeration	11																																						
enumeration	12																																						
enumeration	13																																						
enumeration	14																																						
enumeration	15																																						
enumeration	16																																						
enumeration	17																																						

	enumeration 18 enumeration 19 enumeration 20 enumeration 21
source	<xs:element name="F24DebitoCodRegione" type="sc:Codice_Regione_Type" minOccurs="0"/>

element **Versamenti_F24_Type/F24DebitoAddReg**

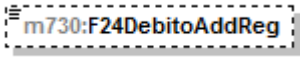
diagram	
namespace	urn:www.agenziaentrate.gov.it:specificheTecniche:sco:730
type	DatoNP_Type
facets	Kind Value pattern [1-9]{1}[0-9]*
source	<xs:element name="F24DebitoAddReg" type="cm:DatoNP_Type" minOccurs="0"/>

element **Versamenti_F24_Type/F24DebitoCodComune**

diagram	
namespace	urn:www.agenziaentrate.gov.it:specificheTecniche:sco:730
type	DatoAN_Type
facets	Kind Value pattern (([0-9A-Z-] \"){1}([0-9A-Z&:] \- \., / \° \^ \(\) À È É Ì Ò Ù Û " \ \+)*
source	<xs:element name="F24DebitoCodComune" type="cm:DatoAN_Type" minOccurs="0"/>

element **Versamenti_F24_Type/F24DebitoAddCom**

diagram	
namespace	urn:www.agenziaentrate.gov.it:specificheTecniche:sco:730
type	DatoNP_Type
facets	Kind Value pattern [1-9]{1}[0-9]*
source	<xs:element name="F24DebitoAddCom" type="cm:DatoNP_Type" minOccurs="0"/>

element **Versamenti_F24_Type/F24DebitoPrimaRataAcclrpef**

diagram	
namespace	urn:www.agenziaentrate.gov.it:specificheTecniche:sco:730
type	DatoNP_Type
facets	Kind Value pattern [1-9]{1}[0-9]*
source	<xs:element name="F24DebitoPrimaRataAcclrpef" type="cm:DatoNP_Type" minOccurs="0"/>

element **Versamenti_F24_Type/F24DebitoAccontoTassSep**

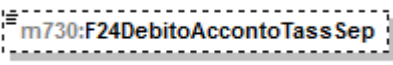
diagram	
namespace	urn:www.agenziaentrate.gov.it:specificheTecniche:sco:730
type	DatoNP_Type
facets	Kind Value pattern [1-9]{1}[0-9]*
source	<xs:element name="F24DebitoAccontoTassSep" type="cm:DatoNP_Type" minOccurs="0"/>

element **Versamenti_F24_Type/F24DebitoCodComuneAcconto**

diagram	
namespace	urn:www.agenziaentrate.gov.it:specificheTecniche:sco:730
type	DatoAN_Type
facets	Kind Value pattern (([0-9A-Z-])"){1}([0-9A-Z&:] \\-\\. , / ^\\(\\) À É Ê Ì Ò Ù Û " \\ \\ \\+)*
source	<xs:element name="F24DebitoCodComuneAcconto" type="cm:DatoAN_Type" minOccurs="0"/>

element **Versamenti_F24_Type/F24DebitoAccontoAddCom**

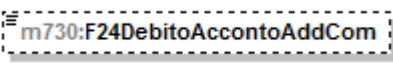
diagram	
namespace	urn:www.agenziaentrate.gov.it:specificheTecniche:sco:730
type	DatoNP_Type
facets	Kind Value pattern [1-9]{1}[0-9]*
source	<xs:element name="F24DebitoAccontoAddCom" type="cm:DatoNP_Type" minOccurs="0"/>

element **Versamenti_F24_Type/F24DebitoImpSostProdut**

diagram	
namespace	urn:www.agenziaentrate.gov.it:specificheTecniche:sco:730
type	DatoNP_Type
facets	Kind Value pattern [1-9]{1}[0-9]*
source	<xs:element name="F24DebitoImpSostProdut" type="cm:DatoNP_Type" minOccurs="0"/>

element **Versamenti_F24_Type/F24DebitoCedolare**

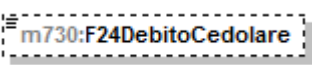
diagram	
namespace	urn:www.agenziaentrate.gov.it:specificheTecniche:sco:730
type	DatoNP_Type
facets	Kind Value pattern [1-9]{1}[0-9]*
source	<xs:element name="F24DebitoCedolare" type="cm:DatoNP_Type" minOccurs="0"/>

element **Versamenti_F24_Type/F24DebitoPrimaRataAccCedolare**

diagram	
namespace	urn:www.agenziaentrate.gov.it:specificheTecniche:sco:730
type	DatoNP_Type
facets	Kind Value pattern [1-9]{1}[0-9]*
source	<xs:element name="F24DebitoPrimaRataAccCedolare" type="cm:DatoNP_Type" minOccurs="0"/>

element **Versamenti_F24_Type/F24DebitoContribSolidarieta**

diagram	
namespace	urn:www.agenziaentrate.gov.it:specificheTecniche:sco:730
type	DatoNP_Type
facets	Kind Value pattern [1-9]{1}[0-9]*
source	<xs:element name="F24DebitoContribSolidarieta" type="cm:DatoNP_Type" minOccurs="0"/>

element **Versamenti_F24_Type/F24DebitoCodRegioneConiuge**

diagram	
namespace	urn:www.agenziaentrate.gov.it:specificheTecniche:sco:730
type	Codice_Regione_Type
facets	Kind Value pattern ([0-9A-Z-] "){1}([0-9A-Z&] ' \"- .!, /° √\(\)\ À É Ê Ï Ò Ù Û Ü " \\" \ +)* enumeration 1 enumeration 2 enumeration 3 enumeration 4 enumeration 5 enumeration 6 enumeration 7 enumeration 8 enumeration 9 enumeration 10 enumeration 11 enumeration 12 enumeration 13 enumeration 14 enumeration 15 enumeration 16 enumeration 17 enumeration 18 enumeration 19 enumeration 20 enumeration 21
source	<xs:element name="F24DebitoCodRegioneConiuge" type="sc:Codice_Regione_Type" minOccurs="0"/>

element **Versamenti_F24_Type/F24DebitoAddRegConiuge**

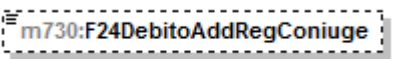
diagram	
namespace	urn:www.agenziaentrate.gov.it:specificheTecniche:sco:730
type	DatoNP_Type
facets	Kind Value pattern [1-9]{1}[0-9]*
source	<xs:element name="F24DebitoAddRegConiuge" type="cm:DatoNP_Type" minOccurs="0"/>

element **Versamenti_F24_Type/F24DebitoCodComuneConiuge**

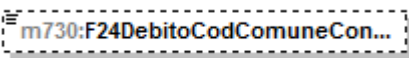
diagram	
namespace	urn:www.agenziaentrate.gov.it:specificheTecniche:sco:730
type	DatoAN_Type
facets	Kind Value pattern (([0-9A-Z-])"){1}([0-9A-Z&:] [-\., / ^\\(\)\}À É È Ì Ò Ù Û " \\ / +)*
source	<xs:element name="F24DebitoCodComuneConiuge" type="cm:DatoAN_Type" minOccurs="0"/>

element **Versamenti_F24_Type/F24DebitoAddComConiuge**

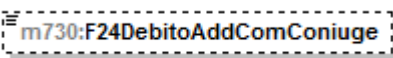
diagram	
namespace	urn:www.agenziaentrate.gov.it:specificheTecniche:sco:730
type	DatoNP_Type
facets	Kind Value pattern [1-9]{1}[0-9]*
source	<xs:element name="F24DebitoAddComConiuge" type="cm:DatoNP_Type" minOccurs="0"/>

element **Versamenti_F24_Type/F24DebitoCodComuneAccontoConiuge**

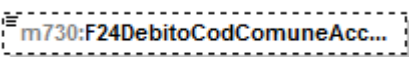
diagram	
namespace	urn:www.agenziaentrate.gov.it:specificheTecniche:sco:730
type	DatoAN_Type
facets	Kind Value pattern (([0-9A-Z-])"){1}([0-9A-Z&:] [-\., / ^\\(\)\}À É È Ì Ò Ù Û " \\ / +)*
source	<xs:element name="F24DebitoCodComuneAccontoConiuge" type="cm:DatoAN_Type" minOccurs="0"/>

element **Versamenti_F24_Type/F24DebitoAccontoAddComConiuge**

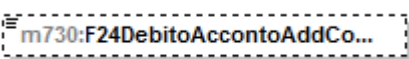
diagram	
namespace	urn:www.agenziaentrate.gov.it:specificheTecniche:sco:730
type	DatoNP_Type
facets	Kind Value pattern [1-9]{1}[0-9]*
source	<xs:element name="F24DebitoAccontoAddComConiuge" type="cm:DatoNP_Type" minOccurs="0"/>

element **Versamenti_F24_Type/F24DebitoSecondaRataAcclrpef**

diagram	
namespace	urn:www.agenziaentrate.gov.it:specificheTecniche:sco:730
type	DatoNP_Type
facets	Kind Value pattern [1-9]{1}[0-9]*
source	<xs:element name="F24DebitoSecondaRataAcclrpef" type="cm:DatoNP_Type" minOccurs="0"/>

element **Versamenti_F24_Type/F24DebitoSecondaRataAccCedolare**

diagram	
namespace	urn:www.agenziaentrate.gov.it:specificheTecniche:sco:730
type	DatoNP_Type
facets	Kind Value pattern [1-9]{1}[0-9]*
source	<xs:element name="F24DebitoSecondaRataAccCedolare" type="cm:DatoNP_Type" minOccurs="0"/>

diagram	
namespace	urn:www.agenziaentrate.gov.it:specificheTecniche:sco:730
children	m730:TipoFornitore m730:SpazioUtente
source	<xs:complexType name="Intestazione_730_Type"> <xs:sequence> <xs:element name="TipoFornitore"> <xs:simpleType> <xs:restriction base="cm:DatoAN_Type"> <xs:enumeration value="1"/> <xs:enumeration value="2"/> <xs:enumeration value="3"/> <xs:enumeration value="5"/> <xs:enumeration value="6"/> <xs:enumeration value="10"/> </xs:restriction> </xs:simpleType> </xs:element> <xs:element name="SpazioUtente" type="cm:DatoAN_Type" minOccurs="0"/> </xs:sequence> </xs:complexType>

element **Intestazione_730_Type/TipoFornitore**

diagram	
namespace	urn:www.agenziaentrate.gov.it:specificheTecniche:sco:730
type	restriction of DatoAN_Type

facets	Kind Value pattern (([0-9A-Z\]"){1}([0-9A-Z&]] \- \., / ^ \^\(\\ \\) À É É ì Ò Ù Ü " \\ \\ \\ +)* enumeration 1 enumeration 2 enumeration 3 enumeration 5 enumeration 6 enumeration 10
source	<pre><xs:element name="TipoFornitore"> <xs:simpleType> <xs:restriction base="cm:DatoAN_Type"> <xs:enumeration value="1"/> <xs:enumeration value="2"/> <xs:enumeration value="3"/> <xs:enumeration value="5"/> <xs:enumeration value="6"/> <xs:enumeration value="10"/> </xs:restriction> </xs:simpleType> </xs:element></pre>

element **Intestazione_730_Type/SpazioUtente**

diagram	
namespace	urn:www.agenziaentrate.gov.it:specificheTecniche:sco:730
type	DatoAN_Type
facets	Kind Value pattern (([0-9A-Z\]"){1}([0-9A-Z&]] \- \., / ^ \^\(\\ \\) À É É ì Ò Ù Ü " \\ \\ \\ +)*
source	<pre><xs:element name="SpazioUtente" type="cm:DatoAN_Type" minOccurs="0"/></pre>

element **Fornitura**

diagram	
namespace	www.agenziaentrate.gov.it:specificheTecniche:telent:v1
source	<pre><xs:element name="Fornitura" abstract="true"/></pre>

element **Messaggio**

diagram	
namespace	www.agenziaentrate.gov.it:specificheTecniche:telent:v1
children	tm:Intestazione tm:Contenuto
source	<pre><xs:element name="Messaggio"> <xs:complexType> <xs:sequence> <xs:element name="Intestazione" type="tm:IntestazioneType" minOccurs="1" maxOccurs="1"/> <xs:element name="Contenuto" type="tm:ContenutoType" minOccurs="1" maxOccurs="1"/> </xs:sequence> </xs:complexType></pre>

	<code></xs:element></code>
--	----------------------------------

element **Messaggio/Intestazione**

diagram	
namespace	www.agenziaentrate.gov.it:specificheTecniche:telent:v1
type	tm:IntestazioneType
children	tm:CodiceFiscaleFornitore tm:SpazioServizioTelematico
source	<code><xs:element name="Intestazione" type="tm:IntestazioneType" minOccurs="1" maxOccurs="1"/></code>

element **Messaggio/Contenuto**

diagram											
namespace	www.agenziaentrate.gov.it:specificheTecniche:telent:v1										
type	tm:ContenutoType										
children	tm:Fornitura										
attributes	<table border="1"> <thead> <tr> <th>Name</th> <th>Type</th> <th>Use</th> <th>Default</th> <th>Fixed</th> </tr> </thead> <tbody> <tr> <td>CodiceFornitura</td> <td>derived by: xs:string</td> <td></td> <td></td> <td></td> </tr> </tbody> </table>	Name	Type	Use	Default	Fixed	CodiceFornitura	derived by: xs:string			
Name	Type	Use	Default	Fixed							
CodiceFornitura	derived by: xs:string										
source	<code><xs:element name="Contenuto" type="tm:ContenutoType" minOccurs="1" maxOccurs="1"/></code>										

complexType **ContenutoType**

diagram	
namespace	www.agenziaentrate.gov.it:specificheTecniche:telent:v1

children	tm:Fornitura				
attributes	Name CodiceFornitura	Type derived by: xs:string	Use	Default	Fixed
source	<pre><xs:complexType name="ContenutoType"> <xs:sequence> <xs:element ref="tm:Fornitura"/> </xs:sequence> <xs:attribute name="CodiceFornitura"> <xs:simpleType> <xs:restriction base="xs:string"> <xs:pattern value="[A-Z0-9]{5}"/> </xs:restriction> </xs:simpleType> </xs:attribute> </xs:complexType></pre>				

attribute **ContenutoType/@CodiceFornitura**

type	restriction of xs:string				
facets	<table border="1"> <tr> <td>Kind</td> <td>Value</td> </tr> <tr> <td>pattern</td> <td>[A-Z0-9]{5}</td> </tr> </table>	Kind	Value	pattern	[A-Z0-9]{5}
Kind	Value				
pattern	[A-Z0-9]{5}				
source	<pre><xs:attribute name="CodiceFornitura"> <xs:simpleType> <xs:restriction base="xs:string"> <xs:pattern value="[A-Z0-9]{5}"/> </xs:restriction> </xs:simpleType> </xs:attribute></pre>				

complexType **IntestazioneType**

diagram	
namespace	www.agenziaentrate.gov.it:specificheTecniche:telent:v1
children	tm:CodiceFiscaleFornitore tm:Spazio Servizio Telematico
source	<pre><xs:complexType name="IntestazioneType"> <xs:sequence> <xs:element name="CodiceFiscaleFornitore" minOccurs="1" maxOccurs="1"> <xs:simpleType> <xs:restriction base="xs:string"> <xs:pattern value="[0-9]{11}[A-Z0-9]{16}"/> </xs:restriction> </xs:simpleType> </xs:element> <xs:element name="Spazio Servizio Telematico" minOccurs="0" maxOccurs="1"> <xs:simpleType> <xs:restriction base="xs:string"/> </xs:simpleType> </xs:element> </xs:sequence> </xs:complexType></pre>

element **IntestazioneType/CodiceFiscaleFornitore**

diagram	
---------	--

namespace	www.agenziaentrate.gov.it:specificheTecniche:telent:v1				
type	restriction of xs:string				
facets	<table border="1"> <thead> <tr> <th>Kind</th> <th>Value</th> </tr> </thead> <tbody> <tr> <td>pattern</td> <td>[0-9]{11}[A-Z0-9]{16}</td> </tr> </tbody> </table>	Kind	Value	pattern	[0-9]{11}[A-Z0-9]{16}
Kind	Value				
pattern	[0-9]{11}[A-Z0-9]{16}				
source	<pre><xs:element name="CodiceFiscaleFornitore" minOccurs="1" maxOccurs="1"> <xs:simpleType> <xs:restriction base="xs:string"> <xs:pattern value="[0-9]{11}[A-Z0-9]{16}"/> </xs:restriction> </xs:simpleType> </xs:element></pre>				

element **IntestazioneType/SpazioServizioTelematico**

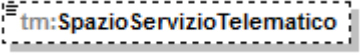
diagram	
namespace	www.agenziaentrate.gov.it:specificheTecniche:telent:v1
type	restriction of xs:string
source	<pre><xs:element name="SpazioServizioTelematico" minOccurs="0" maxOccurs="1"> <xs:simpleType> <xs:restriction base="xs:string"/> </xs:simpleType> </xs:element></pre>

simpleType **Anno_Anticipazione_Fondo_Pensione_Type**

namespace	urn:www.agenziaentrate.gov.it:specificheTecniche:sco:730																				
type	restriction of DatoNP_Type																				
facets	<table border="1"> <thead> <tr> <th>Kind</th> <th>Value</th> </tr> </thead> <tbody> <tr> <td>pattern</td> <td>[1-9]{1}[0-9]*</td> </tr> <tr> <td>enumeration</td> <td>2007</td> </tr> <tr> <td>enumeration</td> <td>2008</td> </tr> <tr> <td>enumeration</td> <td>2009</td> </tr> <tr> <td>enumeration</td> <td>2010</td> </tr> <tr> <td>enumeration</td> <td>2011</td> </tr> <tr> <td>enumeration</td> <td>2012</td> </tr> <tr> <td>enumeration</td> <td>2013</td> </tr> <tr> <td>enumeration</td> <td>2014</td> </tr> </tbody> </table>	Kind	Value	pattern	[1-9]{1}[0-9]*	enumeration	2007	enumeration	2008	enumeration	2009	enumeration	2010	enumeration	2011	enumeration	2012	enumeration	2013	enumeration	2014
Kind	Value																				
pattern	[1-9]{1}[0-9]*																				
enumeration	2007																				
enumeration	2008																				
enumeration	2009																				
enumeration	2010																				
enumeration	2011																				
enumeration	2012																				
enumeration	2013																				
enumeration	2014																				
source	<pre><xs:simpleType name="Anno_Anticipazione_Fondo_Pensione_Type"> <xs:restriction base="cm:DatoNP_Type"> <xs:length value="4"/> <xs:enumeration value="2007"/> <xs:enumeration value="2008"/> <xs:enumeration value="2009"/> <xs:enumeration value="2010"/> <xs:enumeration value="2011"/> <xs:enumeration value="2012"/> <xs:enumeration value="2013"/> <xs:enumeration value="2014"/> </xs:restriction> </xs:simpleType></pre>																				

simpleType **Anno_Patrimonio_Edilizio_Situazioni_Particolari_Type**

namespace	urn:www.agenziaentrate.gov.it:specificheTecniche:sco:730				
type	restriction of DatoNP_Type				
facets	<table border="1"> <thead> <tr> <th>Kind</th> <th>Value</th> </tr> </thead> <tbody> <tr> <td>pattern</td> <td>[1-9]{1}[0-9]*</td> </tr> </tbody> </table>	Kind	Value	pattern	[1-9]{1}[0-9]*
Kind	Value				
pattern	[1-9]{1}[0-9]*				

	enumeration 2010 enumeration 2011
source	<pre><xs:simpleType name="Anno_Patrimonio_Edilizio_Situazioni_Particolari_Type"> <xs:restriction base="cm:DatoNP_Type"> <xs:enumeration value="2010"/> <xs:enumeration value="2011"/> </xs:restriction> </xs:simpleType></pre>

simpleType Anno_Recupero_Patrimonio_Edilizio_Type

namespace	urn:www.agenziaentrate.gov.it:specificheTecniche:sco:730																								
type	restriction of DatoNP_Type																								
facets	<table border="1"> <thead> <tr> <th>Kind</th> <th>Value</th> </tr> </thead> <tbody> <tr> <td>pattern</td> <td>[1-9]{1}[0-9]*</td> </tr> <tr> <td>enumeration</td> <td>2005</td> </tr> <tr> <td>enumeration</td> <td>2006</td> </tr> <tr> <td>enumeration</td> <td>2007</td> </tr> <tr> <td>enumeration</td> <td>2008</td> </tr> <tr> <td>enumeration</td> <td>2009</td> </tr> <tr> <td>enumeration</td> <td>2010</td> </tr> <tr> <td>enumeration</td> <td>2011</td> </tr> <tr> <td>enumeration</td> <td>2012</td> </tr> <tr> <td>enumeration</td> <td>2013</td> </tr> <tr> <td>enumeration</td> <td>2014</td> </tr> </tbody> </table>	Kind	Value	pattern	[1-9]{1}[0-9]*	enumeration	2005	enumeration	2006	enumeration	2007	enumeration	2008	enumeration	2009	enumeration	2010	enumeration	2011	enumeration	2012	enumeration	2013	enumeration	2014
Kind	Value																								
pattern	[1-9]{1}[0-9]*																								
enumeration	2005																								
enumeration	2006																								
enumeration	2007																								
enumeration	2008																								
enumeration	2009																								
enumeration	2010																								
enumeration	2011																								
enumeration	2012																								
enumeration	2013																								
enumeration	2014																								
source	<pre><xs:simpleType name="Anno_Recupero_Patrimonio_Edilizio_Type"> <xs:restriction base="cm:DatoNP_Type"> <xs:enumeration value="2005"/> <xs:enumeration value="2006"/> <xs:enumeration value="2007"/> <xs:enumeration value="2008"/> <xs:enumeration value="2009"/> <xs:enumeration value="2010"/> <xs:enumeration value="2011"/> <xs:enumeration value="2012"/> <xs:enumeration value="2013"/> <xs:enumeration value="2014"/> </xs:restriction> </xs:simpleType></pre>																								

simpleType Anno_Risparmio_Energetico_Type

namespace	urn:www.agenziaentrate.gov.it:specificheTecniche:sco:730																
type	restriction of DatoNP_Type																
facets	<table border="1"> <thead> <tr> <th>Kind</th> <th>Value</th> </tr> </thead> <tbody> <tr> <td>pattern</td> <td>[1-9]{1}[0-9]*</td> </tr> <tr> <td>enumeration</td> <td>2008</td> </tr> <tr> <td>enumeration</td> <td>2010</td> </tr> <tr> <td>enumeration</td> <td>2011</td> </tr> <tr> <td>enumeration</td> <td>2012</td> </tr> <tr> <td>enumeration</td> <td>2013</td> </tr> <tr> <td>enumeration</td> <td>2014</td> </tr> </tbody> </table>	Kind	Value	pattern	[1-9]{1}[0-9]*	enumeration	2008	enumeration	2010	enumeration	2011	enumeration	2012	enumeration	2013	enumeration	2014
Kind	Value																
pattern	[1-9]{1}[0-9]*																
enumeration	2008																
enumeration	2010																
enumeration	2011																
enumeration	2012																
enumeration	2013																
enumeration	2014																
source	<pre><xs:simpleType name="Anno_Risparmio_Energetico_Type"> <xs:restriction base="cm:DatoNP_Type"> <xs:enumeration value="2008"/> <xs:enumeration value="2010"/> <xs:enumeration value="2011"/> <xs:enumeration value="2012"/> <xs:enumeration value="2013"/> <xs:enumeration value="2014"/> </xs:restriction> </xs:simpleType></pre>																

simpleType **Casella_Codice_Type**

namespace	urn:www.agenziaentrate.gov.it:specificheTecniche:sco:730								
type	restriction of DatoN1_Type								
facets	<table border="1"> <thead> <tr> <th>Kind</th> <th>Value</th> </tr> </thead> <tbody> <tr> <td>pattern</td> <td>[1-9]</td> </tr> <tr> <td>enumeration</td> <td>1</td> </tr> <tr> <td>enumeration</td> <td>4</td> </tr> </tbody> </table>	Kind	Value	pattern	[1-9]	enumeration	1	enumeration	4
Kind	Value								
pattern	[1-9]								
enumeration	1								
enumeration	4								
source	<pre><xs:simpleType name="Casella_Codice_Type"> <xs:restriction base="cm:DatoN1_Type"> <xs:enumeration value="1"/> <xs:enumeration value="4"/> </xs:restriction> </xs:simpleType></pre>								

simpleType **Casella_Istruzioni_Type**

namespace	urn:www.agenziaentrate.gov.it:specificheTecniche:sco:730												
type	restriction of DatoN1_Type												
facets	<table border="1"> <thead> <tr> <th>Kind</th> <th>Value</th> </tr> </thead> <tbody> <tr> <td>pattern</td> <td>[1-9]</td> </tr> <tr> <td>enumeration</td> <td>1</td> </tr> <tr> <td>enumeration</td> <td>2</td> </tr> <tr> <td>enumeration</td> <td>3</td> </tr> <tr> <td>enumeration</td> <td>4</td> </tr> </tbody> </table>	Kind	Value	pattern	[1-9]	enumeration	1	enumeration	2	enumeration	3	enumeration	4
Kind	Value												
pattern	[1-9]												
enumeration	1												
enumeration	2												
enumeration	3												
enumeration	4												
source	<pre><xs:simpleType name="Casella_Istruzioni_Type"> <xs:restriction base="cm:DatoN1_Type"> <xs:enumeration value="1"/> <xs:enumeration value="2"/> <xs:enumeration value="3"/> <xs:enumeration value="4"/> </xs:restriction> </xs:simpleType></pre>												

simpleType **Casi_Particolari_Risp_Ener_Type**

namespace	urn:www.agenziaentrate.gov.it:specificheTecniche:sco:730										
type	restriction of DatoN1_Type										
facets	<table border="1"> <thead> <tr> <th>Kind</th> <th>Value</th> </tr> </thead> <tbody> <tr> <td>pattern</td> <td>[1-9]</td> </tr> <tr> <td>enumeration</td> <td>1</td> </tr> <tr> <td>enumeration</td> <td>2</td> </tr> <tr> <td>enumeration</td> <td>3</td> </tr> </tbody> </table>	Kind	Value	pattern	[1-9]	enumeration	1	enumeration	2	enumeration	3
Kind	Value										
pattern	[1-9]										
enumeration	1										
enumeration	2										
enumeration	3										
source	<pre><xs:simpleType name="Casi_Particolari_Risp_Ener_Type"> <xs:restriction base="cm:DatoN1_Type"> <xs:enumeration value="1"/> <xs:enumeration value="2"/> <xs:enumeration value="3"/> </xs:restriction> </xs:simpleType></pre>										

simpleType **CasiParticolariFabbricato_Type**

namespace	urn:www.agenziaentrate.gov.it:specificheTecniche:sco:730												
type	restriction of DatoN1_Type												
facets	<table border="1"> <thead> <tr> <th>Kind</th> <th>Value</th> </tr> </thead> <tbody> <tr> <td>pattern</td> <td>[1-9]</td> </tr> <tr> <td>enumeration</td> <td>1</td> </tr> <tr> <td>enumeration</td> <td>3</td> </tr> <tr> <td>enumeration</td> <td>4</td> </tr> <tr> <td>enumeration</td> <td>5</td> </tr> </tbody> </table>	Kind	Value	pattern	[1-9]	enumeration	1	enumeration	3	enumeration	4	enumeration	5
Kind	Value												
pattern	[1-9]												
enumeration	1												
enumeration	3												
enumeration	4												
enumeration	5												

	enumeration 6
source	<pre><xs:simpleType name="CasiParticolariFabbricato_Type"> <xs:restriction base="cm:DatoN1_Type"> <xs:enumeration value="1"/> <xs:enumeration value="3"/> <xs:enumeration value="4"/> <xs:enumeration value="5"/> <xs:enumeration value="6"/> </xs:restriction> </xs:simpleType></pre>

simpleType **CasiParticolariTerreni_Type**

namespace	urn:www.agenziaentrate.gov.it:specificheTecniche:sco:730												
type	restriction of DatoN1_Type												
facets	<table border="1"> <thead> <tr> <th>Kind</th> <th>Value</th> </tr> </thead> <tbody> <tr> <td>pattern</td> <td>[1-9]</td> </tr> <tr> <td>enumeration</td> <td>2</td> </tr> <tr> <td>enumeration</td> <td>3</td> </tr> <tr> <td>enumeration</td> <td>4</td> </tr> <tr> <td>enumeration</td> <td>6</td> </tr> </tbody> </table>	Kind	Value	pattern	[1-9]	enumeration	2	enumeration	3	enumeration	4	enumeration	6
Kind	Value												
pattern	[1-9]												
enumeration	2												
enumeration	3												
enumeration	4												
enumeration	6												
source	<pre><xs:simpleType name="CasiParticolariTerreni_Type"> <xs:restriction base="cm:DatoN1_Type"> <xs:enumeration value="2"/> <xs:enumeration value="3"/> <xs:enumeration value="4"/> <xs:enumeration value="6"/> </xs:restriction> </xs:simpleType></pre>												

simpleType **Codice_Altre_Detrazioni_Type**

namespace	urn:www.agenziaentrate.gov.it:specificheTecniche:sco:730								
type	restriction of DatoNP_Type								
facets	<table border="1"> <thead> <tr> <th>Kind</th> <th>Value</th> </tr> </thead> <tbody> <tr> <td>pattern</td> <td>[1-9]{1}[0-9]*</td> </tr> <tr> <td>enumeration</td> <td>1</td> </tr> <tr> <td>enumeration</td> <td>2</td> </tr> </tbody> </table>	Kind	Value	pattern	[1-9]{1}[0-9]*	enumeration	1	enumeration	2
Kind	Value								
pattern	[1-9]{1}[0-9]*								
enumeration	1								
enumeration	2								
source	<pre><xs:simpleType name="Codice_Altre_Detrazioni_Type"> <xs:restriction base="cm:DatoNP_Type"> <xs:enumeration value="1"/> <xs:enumeration value="2"/> </xs:restriction> </xs:simpleType></pre>								

simpleType **Codice_Altre_Spese_Type**

namespace	urn:www.agenziaentrate.gov.it:specificheTecniche:sco:730																										
type	restriction of DatoNP_Type																										
facets	<table border="1"> <thead> <tr> <th>Kind</th> <th>Value</th> </tr> </thead> <tbody> <tr> <td>pattern</td> <td>[1-9]{1}[0-9]*</td> </tr> <tr> <td>enumeration</td> <td>8</td> </tr> <tr> <td>enumeration</td> <td>9</td> </tr> <tr> <td>enumeration</td> <td>10</td> </tr> <tr> <td>enumeration</td> <td>11</td> </tr> <tr> <td>enumeration</td> <td>13</td> </tr> <tr> <td>enumeration</td> <td>14</td> </tr> <tr> <td>enumeration</td> <td>15</td> </tr> <tr> <td>enumeration</td> <td>16</td> </tr> <tr> <td>enumeration</td> <td>17</td> </tr> <tr> <td>enumeration</td> <td>18</td> </tr> <tr> <td>enumeration</td> <td>20</td> </tr> </tbody> </table>	Kind	Value	pattern	[1-9]{1}[0-9]*	enumeration	8	enumeration	9	enumeration	10	enumeration	11	enumeration	13	enumeration	14	enumeration	15	enumeration	16	enumeration	17	enumeration	18	enumeration	20
Kind	Value																										
pattern	[1-9]{1}[0-9]*																										
enumeration	8																										
enumeration	9																										
enumeration	10																										
enumeration	11																										
enumeration	13																										
enumeration	14																										
enumeration	15																										
enumeration	16																										
enumeration	17																										
enumeration	18																										
enumeration	20																										

	enumeration 21 enumeration 22 enumeration 23 enumeration 24 enumeration 25 enumeration 26 enumeration 27 enumeration 28 enumeration 29 enumeration 30 enumeration 31 enumeration 32 enumeration 33 enumeration 35 enumeration 36 enumeration 37 enumeration 41 enumeration 42 enumeration 99
source	<pre> <xs:simpleType name="Codice_Altre_Spese_Type"> <xs:restriction base="cm:DatoNP_Type"> <xs:enumeration value="8"/> <xs:enumeration value="9"/> <xs:enumeration value="10"/> <xs:enumeration value="11"/> <xs:enumeration value="13"/> <xs:enumeration value="14"/> <xs:enumeration value="15"/> <xs:enumeration value="16"/> <xs:enumeration value="17"/> <xs:enumeration value="18"/> <xs:enumeration value="20"/> <xs:enumeration value="21"/> <xs:enumeration value="22"/> <xs:enumeration value="23"/> <xs:enumeration value="24"/> <xs:enumeration value="25"/> <xs:enumeration value="26"/> <xs:enumeration value="27"/> <xs:enumeration value="28"/> <xs:enumeration value="29"/> <xs:enumeration value="30"/> <xs:enumeration value="31"/> <xs:enumeration value="32"/> <xs:enumeration value="33"/> <xs:enumeration value="35"/> <xs:enumeration value="36"/> <xs:enumeration value="37"/> <xs:enumeration value="41"/> <xs:enumeration value="42"/> <xs:enumeration value="99"/> </xs:restriction> </xs:simpleType> </pre>

simpleType Codice_Altri_Oneri_Type

namespace	urn:www.agenziaentrate.gov.it:specificheTecniche:sco:730																
type	restriction of DatoNP_Type																
facets	<table border="1"> <thead> <tr> <th>Kind</th> <th>Value</th> </tr> </thead> <tbody> <tr> <td>pattern</td> <td>[1-9]{1}[0-9]*</td> </tr> <tr> <td>enumeration</td> <td>1</td> </tr> <tr> <td>enumeration</td> <td>2</td> </tr> <tr> <td>enumeration</td> <td>3</td> </tr> <tr> <td>enumeration</td> <td>4</td> </tr> <tr> <td>enumeration</td> <td>5</td> </tr> <tr> <td>enumeration</td> <td>6</td> </tr> </tbody> </table>	Kind	Value	pattern	[1-9]{1}[0-9]*	enumeration	1	enumeration	2	enumeration	3	enumeration	4	enumeration	5	enumeration	6
Kind	Value																
pattern	[1-9]{1}[0-9]*																
enumeration	1																
enumeration	2																
enumeration	3																
enumeration	4																
enumeration	5																
enumeration	6																

source	<pre> <xs:simpleType name="Codice_Altri_Oneri_Type"> <xs:restriction base="cm:DatoNP_Type"> <xs:enumeration value="1"/> <xs:enumeration value="2"/> <xs:enumeration value="3"/> <xs:enumeration value="4"/> <xs:enumeration value="5"/> <xs:enumeration value="6"/> </xs:restriction> </xs:simpleType> </pre>
--------	---

simpleType Codice_Evento_Eccezionale_Type

namespace	urn:www.agenziaentrate.gov.it:specificheTecniche:sco:730																				
type	restriction of DatoN1_Type																				
facets	<table border="1"> <thead> <tr> <th>Kind</th> <th>Value</th> </tr> </thead> <tbody> <tr> <td>pattern</td> <td>[1-9]</td> </tr> <tr> <td>enumeration</td> <td>1</td> </tr> <tr> <td>enumeration</td> <td>2</td> </tr> <tr> <td>enumeration</td> <td>3</td> </tr> <tr> <td>enumeration</td> <td>4</td> </tr> <tr> <td>enumeration</td> <td>5</td> </tr> <tr> <td>enumeration</td> <td>6</td> </tr> <tr> <td>enumeration</td> <td>7</td> </tr> <tr> <td>enumeration</td> <td>8</td> </tr> </tbody> </table>	Kind	Value	pattern	[1-9]	enumeration	1	enumeration	2	enumeration	3	enumeration	4	enumeration	5	enumeration	6	enumeration	7	enumeration	8
Kind	Value																				
pattern	[1-9]																				
enumeration	1																				
enumeration	2																				
enumeration	3																				
enumeration	4																				
enumeration	5																				
enumeration	6																				
enumeration	7																				
enumeration	8																				
source	<pre> <xs:simpleType name="Codice_Evento_Eccezionale_Type"> <xs:restriction base="cm:DatoN1_Type"> <xs:enumeration value="1"/> <xs:enumeration value="2"/> <xs:enumeration value="3"/> <xs:enumeration value="4"/> <xs:enumeration value="5"/> <xs:enumeration value="6"/> <xs:enumeration value="7"/> <xs:enumeration value="8"/> </xs:restriction> </xs:simpleType> </pre>																				

simpleType Codice_Spese_Rateizzate_Anni_Precedenti_Type

namespace	urn:www.agenziaentrate.gov.it:specificheTecniche:sco:730										
type	restriction of DatoNP_Type										
facets	<table border="1"> <thead> <tr> <th>Kind</th> <th>Value</th> </tr> </thead> <tbody> <tr> <td>pattern</td> <td>[1-9]{1}[0-9]*</td> </tr> <tr> <td>enumeration</td> <td>2</td> </tr> <tr> <td>enumeration</td> <td>3</td> </tr> <tr> <td>enumeration</td> <td>4</td> </tr> </tbody> </table>	Kind	Value	pattern	[1-9]{1}[0-9]*	enumeration	2	enumeration	3	enumeration	4
Kind	Value										
pattern	[1-9]{1}[0-9]*										
enumeration	2										
enumeration	3										
enumeration	4										
source	<pre> <xs:simpleType name="Codice_Spese_Rateizzate_Anni_Precedenti_Type"> <xs:restriction base="cm:DatoNP_Type"> <xs:enumeration value="2"/> <xs:enumeration value="3"/> <xs:enumeration value="4"/> </xs:restriction> </xs:simpleType> </pre>										

simpleType Codice_Spese_Rateizzate_Type

namespace	urn:www.agenziaentrate.gov.it:specificheTecniche:sco:730						
type	restriction of DatoNP_Type						
facets	<table border="1"> <thead> <tr> <th>Kind</th> <th>Value</th> </tr> </thead> <tbody> <tr> <td>pattern</td> <td>[1-9]{1}[0-9]*</td> </tr> <tr> <td>enumeration</td> <td>1</td> </tr> </tbody> </table>	Kind	Value	pattern	[1-9]{1}[0-9]*	enumeration	1
Kind	Value						
pattern	[1-9]{1}[0-9]*						
enumeration	1						

	enumeration 2 enumeration 3 enumeration 4
source	<pre><xs:simpleType name="Codice_Spese_Rateizzate_Type"> <xs:restriction base="cm:DatoNP_Type"> <xs:enumeration value="1"/> <xs:enumeration value="2"/> <xs:enumeration value="3"/> <xs:enumeration value="4"/> </xs:restriction> </xs:simpleType></pre>

simpleType CodiceCanone_Type

namespace	urn:www.agenziaentrate.gov.it:specificheTecniche:sco:730												
type	restriction of DatoN1_Type												
facets	<table border="1"> <thead> <tr> <th>Kind</th> <th>Value</th> </tr> </thead> <tbody> <tr> <td>pattern</td> <td>[1-9]</td> </tr> <tr> <td>enumeration</td> <td>1</td> </tr> <tr> <td>enumeration</td> <td>2</td> </tr> <tr> <td>enumeration</td> <td>3</td> </tr> <tr> <td>enumeration</td> <td>4</td> </tr> </tbody> </table>	Kind	Value	pattern	[1-9]	enumeration	1	enumeration	2	enumeration	3	enumeration	4
Kind	Value												
pattern	[1-9]												
enumeration	1												
enumeration	2												
enumeration	3												
enumeration	4												
source	<pre><xs:simpleType name="CodiceCanone_Type"> <xs:restriction base="cm:DatoN1_Type"> <xs:enumeration value="1"/> <xs:enumeration value="2"/> <xs:enumeration value="3"/> <xs:enumeration value="4"/> </xs:restriction> </xs:simpleType></pre>												

simpleType FabbriatoAgev_Numero_Rigo_Type

namespace	urn:www.agenziaentrate.gov.it:specificheTecniche:sco:730																								
type	restriction of DatoNP_Type																								
facets	<table border="1"> <thead> <tr> <th>Kind</th> <th>Value</th> </tr> </thead> <tbody> <tr> <td>pattern</td> <td>[1-9]{1}[0-9]*</td> </tr> <tr> <td>enumeration</td> <td>1</td> </tr> <tr> <td>enumeration</td> <td>2</td> </tr> <tr> <td>enumeration</td> <td>3</td> </tr> <tr> <td>enumeration</td> <td>4</td> </tr> <tr> <td>enumeration</td> <td>5</td> </tr> <tr> <td>enumeration</td> <td>6</td> </tr> <tr> <td>enumeration</td> <td>7</td> </tr> <tr> <td>enumeration</td> <td>8</td> </tr> <tr> <td>enumeration</td> <td>9</td> </tr> <tr> <td>enumeration</td> <td>10</td> </tr> </tbody> </table>	Kind	Value	pattern	[1-9]{1}[0-9]*	enumeration	1	enumeration	2	enumeration	3	enumeration	4	enumeration	5	enumeration	6	enumeration	7	enumeration	8	enumeration	9	enumeration	10
Kind	Value																								
pattern	[1-9]{1}[0-9]*																								
enumeration	1																								
enumeration	2																								
enumeration	3																								
enumeration	4																								
enumeration	5																								
enumeration	6																								
enumeration	7																								
enumeration	8																								
enumeration	9																								
enumeration	10																								
source	<pre><xs:simpleType name="FabbriatoAgev_Numero_Rigo_Type"> <xs:restriction base="cm:DatoNP_Type"> <xs:enumeration value="1"/> <xs:enumeration value="2"/> <xs:enumeration value="3"/> <xs:enumeration value="4"/> <xs:enumeration value="5"/> <xs:enumeration value="6"/> <xs:enumeration value="7"/> <xs:enumeration value="8"/> <xs:enumeration value="9"/> <xs:enumeration value="10"/> </xs:restriction> </xs:simpleType></pre>																								

	enumeration 9 enumeration 10 enumeration 11 enumeration 12
source	<pre> <xs:simpleType name="Mesi_Type"> <xs:restriction base="cm:DatoNP_Type"> <xs:enumeration value="1"/> <xs:enumeration value="2"/> <xs:enumeration value="3"/> <xs:enumeration value="4"/> <xs:enumeration value="5"/> <xs:enumeration value="6"/> <xs:enumeration value="7"/> <xs:enumeration value="8"/> <xs:enumeration value="9"/> <xs:enumeration value="10"/> <xs:enumeration value="11"/> <xs:enumeration value="12"/> </xs:restriction> </xs:simpleType> </pre>

simpleType **Numero_Rata_Risparmi_Energetico_Type**

namespace	urn:www.agenziaentrate.gov.it:specificheTecniche:sco:730																		
type	restriction of DatoNP_Type																		
facets	<table border="1"> <thead> <tr> <th>Kind</th> <th>Value</th> </tr> </thead> <tbody> <tr> <td>pattern</td> <td>[1-9]{1}[0-9]*</td> </tr> <tr> <td>enumeration</td> <td>1</td> </tr> <tr> <td>enumeration</td> <td>2</td> </tr> <tr> <td>enumeration</td> <td>3</td> </tr> <tr> <td>enumeration</td> <td>4</td> </tr> <tr> <td>enumeration</td> <td>5</td> </tr> <tr> <td>enumeration</td> <td>6</td> </tr> <tr> <td>enumeration</td> <td>7</td> </tr> </tbody> </table>	Kind	Value	pattern	[1-9]{1}[0-9]*	enumeration	1	enumeration	2	enumeration	3	enumeration	4	enumeration	5	enumeration	6	enumeration	7
Kind	Value																		
pattern	[1-9]{1}[0-9]*																		
enumeration	1																		
enumeration	2																		
enumeration	3																		
enumeration	4																		
enumeration	5																		
enumeration	6																		
enumeration	7																		
source	<pre> <xs:simpleType name="Numero_Rata_Risparmi_Energetico_Type"> <xs:restriction base="cm:DatoNP_Type"> <xs:enumeration value="1"/> <xs:enumeration value="2"/> <xs:enumeration value="3"/> <xs:enumeration value="4"/> <xs:enumeration value="5"/> <xs:enumeration value="6"/> <xs:enumeration value="7"/> </xs:restriction> </xs:simpleType> </pre>																		

simpleType **Numero_Rate5o10_Type**

namespace	urn:www.agenziaentrate.gov.it:specificheTecniche:sco:730								
type	restriction of DatoNP_Type								
facets	<table border="1"> <thead> <tr> <th>Kind</th> <th>Value</th> </tr> </thead> <tbody> <tr> <td>pattern</td> <td>[1-9]{1}[0-9]*</td> </tr> <tr> <td>enumeration</td> <td>5</td> </tr> <tr> <td>enumeration</td> <td>10</td> </tr> </tbody> </table>	Kind	Value	pattern	[1-9]{1}[0-9]*	enumeration	5	enumeration	10
Kind	Value								
pattern	[1-9]{1}[0-9]*								
enumeration	5								
enumeration	10								
source	<pre> <xs:simpleType name="Numero_Rate5o10_Type"> <xs:restriction base="cm:DatoNP_Type"> <xs:maxLength value="2"/> <xs:enumeration value="5"/> <xs:enumeration value="10"/> </xs:restriction> </xs:simpleType> </pre>								

simpleType **Numero_RateDa1A2_Type**

namespace	urn:www.agenziaentrate.gov.it:specificheTecniche:sco:730								
type	restriction of DatoN1_Type								
facets	<table border="1"> <thead> <tr> <th>Kind</th> <th>Value</th> </tr> </thead> <tbody> <tr> <td>pattern</td> <td>[1-9]</td> </tr> <tr> <td>enumeration</td> <td>1</td> </tr> <tr> <td>enumeration</td> <td>2</td> </tr> </tbody> </table>	Kind	Value	pattern	[1-9]	enumeration	1	enumeration	2
Kind	Value								
pattern	[1-9]								
enumeration	1								
enumeration	2								
source	<pre><xs:simpleType name="Numero_RateDa1A2_Type"> <xs:restriction base="cm:DatoN1_Type"> <xs:enumeration value="1"/> <xs:enumeration value="2"/> </xs:restriction> </xs:simpleType></pre>								

simpleType **Numero_RateDa1A3_Type**

namespace	urn:www.agenziaentrate.gov.it:specificheTecniche:sco:730										
type	restriction of DatoN1_Type										
facets	<table border="1"> <thead> <tr> <th>Kind</th> <th>Value</th> </tr> </thead> <tbody> <tr> <td>pattern</td> <td>[1-9]</td> </tr> <tr> <td>enumeration</td> <td>1</td> </tr> <tr> <td>enumeration</td> <td>2</td> </tr> <tr> <td>enumeration</td> <td>3</td> </tr> </tbody> </table>	Kind	Value	pattern	[1-9]	enumeration	1	enumeration	2	enumeration	3
Kind	Value										
pattern	[1-9]										
enumeration	1										
enumeration	2										
enumeration	3										
source	<pre><xs:simpleType name="Numero_RateDa1A3_Type"> <xs:restriction base="cm:DatoN1_Type"> <xs:enumeration value="1"/> <xs:enumeration value="2"/> <xs:enumeration value="3"/> </xs:restriction> </xs:simpleType></pre>										

simpleType **Numero_RateDa1A4_Type**

namespace	urn:www.agenziaentrate.gov.it:specificheTecniche:sco:730												
type	restriction of DatoN1_Type												
facets	<table border="1"> <thead> <tr> <th>Kind</th> <th>Value</th> </tr> </thead> <tbody> <tr> <td>pattern</td> <td>[1-9]</td> </tr> <tr> <td>enumeration</td> <td>1</td> </tr> <tr> <td>enumeration</td> <td>2</td> </tr> <tr> <td>enumeration</td> <td>3</td> </tr> <tr> <td>enumeration</td> <td>4</td> </tr> </tbody> </table>	Kind	Value	pattern	[1-9]	enumeration	1	enumeration	2	enumeration	3	enumeration	4
Kind	Value												
pattern	[1-9]												
enumeration	1												
enumeration	2												
enumeration	3												
enumeration	4												
source	<pre><xs:simpleType name="Numero_RateDa1A4_Type"> <xs:restriction base="cm:DatoN1_Type"> <xs:enumeration value="1"/> <xs:enumeration value="2"/> <xs:enumeration value="3"/> <xs:enumeration value="4"/> </xs:restriction> </xs:simpleType></pre>												

simpleType **Numero_RateDa1A5_Type**

namespace	urn:www.agenziaentrate.gov.it:specificheTecniche:sco:730												
type	restriction of DatoN1_Type												
facets	<table border="1"> <thead> <tr> <th>Kind</th> <th>Value</th> </tr> </thead> <tbody> <tr> <td>pattern</td> <td>[1-9]</td> </tr> <tr> <td>enumeration</td> <td>1</td> </tr> <tr> <td>enumeration</td> <td>2</td> </tr> <tr> <td>enumeration</td> <td>3</td> </tr> <tr> <td>enumeration</td> <td>4</td> </tr> </tbody> </table>	Kind	Value	pattern	[1-9]	enumeration	1	enumeration	2	enumeration	3	enumeration	4
Kind	Value												
pattern	[1-9]												
enumeration	1												
enumeration	2												
enumeration	3												
enumeration	4												

	enumeration 5
source	<pre><xs:simpleType name="Numero_RateDa1A5_Type"> <xs:restriction base="cm:DatoN1_Type"> <xs:enumeration value="1"/> <xs:enumeration value="2"/> <xs:enumeration value="3"/> <xs:enumeration value="4"/> <xs:enumeration value="5"/> </xs:restriction> </xs:simpleType></pre>

simpleType Numero_RateDa1A6_Type

namespace	urn:www.agenziaentrate.gov.it:specificheTecniche:sco:730																
type	restriction of DatoN1_Type																
facets	<table border="1"> <thead> <tr> <th>Kind</th> <th>Value</th> </tr> </thead> <tbody> <tr> <td>pattern</td> <td>[1-9]</td> </tr> <tr> <td>enumeration</td> <td>1</td> </tr> <tr> <td>enumeration</td> <td>2</td> </tr> <tr> <td>enumeration</td> <td>3</td> </tr> <tr> <td>enumeration</td> <td>4</td> </tr> <tr> <td>enumeration</td> <td>5</td> </tr> <tr> <td>enumeration</td> <td>6</td> </tr> </tbody> </table>	Kind	Value	pattern	[1-9]	enumeration	1	enumeration	2	enumeration	3	enumeration	4	enumeration	5	enumeration	6
Kind	Value																
pattern	[1-9]																
enumeration	1																
enumeration	2																
enumeration	3																
enumeration	4																
enumeration	5																
enumeration	6																
source	<pre><xs:simpleType name="Numero_RateDa1A6_Type"> <xs:restriction base="cm:DatoN1_Type"> <xs:enumeration value="1"/> <xs:enumeration value="2"/> <xs:enumeration value="3"/> <xs:enumeration value="4"/> <xs:enumeration value="5"/> <xs:enumeration value="6"/> </xs:restriction> </xs:simpleType></pre>																

simpleType Numero_RateDa2A5_Type

namespace	urn:www.agenziaentrate.gov.it:specificheTecniche:sco:730												
type	restriction of DatoNP_Type												
facets	<table border="1"> <thead> <tr> <th>Kind</th> <th>Value</th> </tr> </thead> <tbody> <tr> <td>pattern</td> <td>[1-9]{1}[0-9]*</td> </tr> <tr> <td>enumeration</td> <td>2</td> </tr> <tr> <td>enumeration</td> <td>3</td> </tr> <tr> <td>enumeration</td> <td>4</td> </tr> <tr> <td>enumeration</td> <td>5</td> </tr> </tbody> </table>	Kind	Value	pattern	[1-9]{1}[0-9]*	enumeration	2	enumeration	3	enumeration	4	enumeration	5
Kind	Value												
pattern	[1-9]{1}[0-9]*												
enumeration	2												
enumeration	3												
enumeration	4												
enumeration	5												
source	<pre><xs:simpleType name="Numero_RateDa2A5_Type"> <xs:restriction base="cm:DatoNP_Type"> <xs:length value="1"/> <xs:enumeration value="2"/> <xs:enumeration value="3"/> <xs:enumeration value="4"/> <xs:enumeration value="5"/> </xs:restriction> </xs:simpleType></pre>												

simpleType Periodo_Spese_Ristrutturazione_Type

namespace	urn:www.agenziaentrate.gov.it:specificheTecniche:sco:730								
type	restriction of DatoN1_Type								
facets	<table border="1"> <thead> <tr> <th>Kind</th> <th>Value</th> </tr> </thead> <tbody> <tr> <td>pattern</td> <td>[1-9]</td> </tr> <tr> <td>enumeration</td> <td>1</td> </tr> <tr> <td>enumeration</td> <td>2</td> </tr> </tbody> </table>	Kind	Value	pattern	[1-9]	enumeration	1	enumeration	2
Kind	Value								
pattern	[1-9]								
enumeration	1								
enumeration	2								

	enumeration 3 enumeration 4
source	<pre><xs:simpleType name="Periodo_Spese_Ristrutturazione_Type"> <xs:restriction base="cm:DatoN1_Type"> <xs:enumeration value="1"/> <xs:enumeration value="2"/> <xs:enumeration value="3"/> <xs:enumeration value="4"/> </xs:restriction> </xs:simpleType></pre>

simpleType Rate10_Type

namespace	urn:www.agenziaentrate.gov.it:specificheTecniche:sco:730																								
type	restriction of DatoNP_Type																								
facets	<table border="1"> <thead> <tr> <th>Kind</th> <th>Value</th> </tr> </thead> <tbody> <tr> <td>pattern</td> <td>[1-9]{1}[0-9]*</td> </tr> <tr> <td>enumeration</td> <td>1</td> </tr> <tr> <td>enumeration</td> <td>2</td> </tr> <tr> <td>enumeration</td> <td>3</td> </tr> <tr> <td>enumeration</td> <td>4</td> </tr> <tr> <td>enumeration</td> <td>5</td> </tr> <tr> <td>enumeration</td> <td>6</td> </tr> <tr> <td>enumeration</td> <td>7</td> </tr> <tr> <td>enumeration</td> <td>8</td> </tr> <tr> <td>enumeration</td> <td>9</td> </tr> <tr> <td>enumeration</td> <td>10</td> </tr> </tbody> </table>	Kind	Value	pattern	[1-9]{1}[0-9]*	enumeration	1	enumeration	2	enumeration	3	enumeration	4	enumeration	5	enumeration	6	enumeration	7	enumeration	8	enumeration	9	enumeration	10
Kind	Value																								
pattern	[1-9]{1}[0-9]*																								
enumeration	1																								
enumeration	2																								
enumeration	3																								
enumeration	4																								
enumeration	5																								
enumeration	6																								
enumeration	7																								
enumeration	8																								
enumeration	9																								
enumeration	10																								
source	<pre><xs:simpleType name="Rate10_Type"> <xs:restriction base="cm:DatoNP_Type"> <xs:enumeration value="1"/> <xs:enumeration value="2"/> <xs:enumeration value="3"/> <xs:enumeration value="4"/> <xs:enumeration value="5"/> <xs:enumeration value="6"/> <xs:enumeration value="7"/> <xs:enumeration value="8"/> <xs:enumeration value="9"/> <xs:enumeration value="10"/> </xs:restriction> </xs:simpleType></pre>																								

simpleType Rate5_Type

namespace	urn:www.agenziaentrate.gov.it:specificheTecniche:sco:730								
type	restriction of DatoNP_Type								
facets	<table border="1"> <thead> <tr> <th>Kind</th> <th>Value</th> </tr> </thead> <tbody> <tr> <td>pattern</td> <td>[1-9]{1}[0-9]*</td> </tr> <tr> <td>enumeration</td> <td>4</td> </tr> <tr> <td>enumeration</td> <td>5</td> </tr> </tbody> </table>	Kind	Value	pattern	[1-9]{1}[0-9]*	enumeration	4	enumeration	5
Kind	Value								
pattern	[1-9]{1}[0-9]*								
enumeration	4								
enumeration	5								
source	<pre><xs:simpleType name="Rate5_Type"> <xs:restriction base="cm:DatoNP_Type"> <xs:enumeration value="4"/> <xs:enumeration value="5"/> </xs:restriction> </xs:simpleType></pre>								

simpleType Rate_Risparmio_Energetico_Type

namespace	urn:www.agenziaentrate.gov.it:specificheTecniche:sco:730
type	restriction of DatoNP_Type

facets	<table> <thead> <tr> <th>Kind</th> <th>Value</th> </tr> </thead> <tbody> <tr> <td>pattern</td> <td>[1-9]{1}[0-9]*</td> </tr> <tr> <td>enumeration</td> <td>3</td> </tr> <tr> <td>enumeration</td> <td>4</td> </tr> <tr> <td>enumeration</td> <td>5</td> </tr> <tr> <td>enumeration</td> <td>6</td> </tr> <tr> <td>enumeration</td> <td>7</td> </tr> <tr> <td>enumeration</td> <td>8</td> </tr> <tr> <td>enumeration</td> <td>9</td> </tr> <tr> <td>enumeration</td> <td>10</td> </tr> </tbody> </table>	Kind	Value	pattern	[1-9]{1}[0-9]*	enumeration	3	enumeration	4	enumeration	5	enumeration	6	enumeration	7	enumeration	8	enumeration	9	enumeration	10
Kind	Value																				
pattern	[1-9]{1}[0-9]*																				
enumeration	3																				
enumeration	4																				
enumeration	5																				
enumeration	6																				
enumeration	7																				
enumeration	8																				
enumeration	9																				
enumeration	10																				
source	<pre><xs:simpleType name="Rate_Risparmio_Energetico_Type"> <xs:restriction base="cm:DatoNP_Type"> <xs:enumeration value="3"/> <xs:enumeration value="4"/> <xs:enumeration value="5"/> <xs:enumeration value="6"/> <xs:enumeration value="7"/> <xs:enumeration value="8"/> <xs:enumeration value="9"/> <xs:enumeration value="10"/> </xs:restriction> </xs:simpleType></pre>																				

simpleType Reintegro_Totale_Parziale_Type

namespace	urn:www.agenziaentrate.gov.it:specificheTecniche:sco:730								
type	restriction of DatoN1_Type								
facets	<table> <thead> <tr> <th>Kind</th> <th>Value</th> </tr> </thead> <tbody> <tr> <td>pattern</td> <td>[1-9]</td> </tr> <tr> <td>enumeration</td> <td>1</td> </tr> <tr> <td>enumeration</td> <td>2</td> </tr> </tbody> </table>	Kind	Value	pattern	[1-9]	enumeration	1	enumeration	2
Kind	Value								
pattern	[1-9]								
enumeration	1								
enumeration	2								
source	<pre><xs:simpleType name="Reintegro_Totale_Parziale_Type"> <xs:restriction base="cm:DatoN1_Type"> <xs:enumeration value="1"/> <xs:enumeration value="2"/> </xs:restriction> </xs:simpleType></pre>								

simpleType Rettificativo_Type

namespace	urn:www.agenziaentrate.gov.it:specificheTecniche:sco:730										
type	restriction of DatoN1_Type										
facets	<table> <thead> <tr> <th>Kind</th> <th>Value</th> </tr> </thead> <tbody> <tr> <td>pattern</td> <td>[1-9]</td> </tr> <tr> <td>enumeration</td> <td>1</td> </tr> <tr> <td>enumeration</td> <td>2</td> </tr> <tr> <td>enumeration</td> <td>3</td> </tr> </tbody> </table>	Kind	Value	pattern	[1-9]	enumeration	1	enumeration	2	enumeration	3
Kind	Value										
pattern	[1-9]										
enumeration	1										
enumeration	2										
enumeration	3										
source	<pre><xs:simpleType name="Rettificativo_Type"> <xs:restriction base="cm:DatoN1_Type"> <xs:enumeration value="1"/> <xs:enumeration value="2"/> <xs:enumeration value="3"/> </xs:restriction> </xs:simpleType></pre>										

simpleType Rideterminazione_Rate_Type

namespace	urn:www.agenziaentrate.gov.it:specificheTecniche:sco:730						
type	restriction of DatoNP_Type						
facets	<table> <thead> <tr> <th>Kind</th> <th>Value</th> </tr> </thead> <tbody> <tr> <td>pattern</td> <td>[1-9]{1}[0-9]*</td> </tr> <tr> <td>enumeration</td> <td>10</td> </tr> </tbody> </table>	Kind	Value	pattern	[1-9]{1}[0-9]*	enumeration	10
Kind	Value						
pattern	[1-9]{1}[0-9]*						
enumeration	10						

source	<pre><xs:simpleType name="Rideterminazione_Rate_Type"> <xs:restriction base="cm:DatoNP_Type"> <xs:enumeration value="10"/> </xs:restriction> </xs:simpleType></pre>
--------	---

simpleType Ripart_Risparmio_Energetico_Type

namespace	urn:www.agenziaentrate.gov.it:specificheTecniche:sco:730																		
type	restriction of DatoNP_Type																		
facets	<table border="1"> <thead> <tr> <th>Kind</th> <th>Value</th> </tr> </thead> <tbody> <tr> <td>pattern</td> <td>[1-9]{1}[0-9]*</td> </tr> <tr> <td>enumeration</td> <td>4</td> </tr> <tr> <td>enumeration</td> <td>5</td> </tr> <tr> <td>enumeration</td> <td>6</td> </tr> <tr> <td>enumeration</td> <td>7</td> </tr> <tr> <td>enumeration</td> <td>8</td> </tr> <tr> <td>enumeration</td> <td>9</td> </tr> <tr> <td>enumeration</td> <td>10</td> </tr> </tbody> </table>	Kind	Value	pattern	[1-9]{1}[0-9]*	enumeration	4	enumeration	5	enumeration	6	enumeration	7	enumeration	8	enumeration	9	enumeration	10
Kind	Value																		
pattern	[1-9]{1}[0-9]*																		
enumeration	4																		
enumeration	5																		
enumeration	6																		
enumeration	7																		
enumeration	8																		
enumeration	9																		
enumeration	10																		
source	<pre><xs:simpleType name="Ripart_Risparmio_Energetico_Type"> <xs:restriction base="cm:DatoNP_Type"> <xs:enumeration value="4"/> <xs:enumeration value="5"/> <xs:enumeration value="6"/> <xs:enumeration value="7"/> <xs:enumeration value="8"/> <xs:enumeration value="9"/> <xs:enumeration value="10"/> </xs:restriction> </xs:simpleType></pre>																		

simpleType Serie_Registrazione_Contratto_Type

namespace	urn:www.agenziaentrate.gov.it:specificheTecniche:sco:730														
type	restriction of DatoAN_Type														
facets	<table border="1"> <thead> <tr> <th>Kind</th> <th>Value</th> </tr> </thead> <tbody> <tr> <td>pattern</td> <td>([0-9A-Z-]]&quot;){1}([0-9A-Z&amp;]] [-. \. /° °\^\\(\) À É É ì Ò Ù Ü &quot; \\ / +)*</td> </tr> <tr> <td>enumeration</td> <td>3</td> </tr> <tr> <td>enumeration</td> <td>3A</td> </tr> <tr> <td>enumeration</td> <td>3B</td> </tr> <tr> <td>enumeration</td> <td>3P</td> </tr> <tr> <td>enumeration</td> <td>3T</td> </tr> </tbody> </table>	Kind	Value	pattern	([0-9A-Z-]]"){1}([0-9A-Z&]] [-. \. /° °\^\\(\) À É É ì Ò Ù Ü " \\ / +)*	enumeration	3	enumeration	3A	enumeration	3B	enumeration	3P	enumeration	3T
Kind	Value														
pattern	([0-9A-Z-]]"){1}([0-9A-Z&]] [-. \. /° °\^\\(\) À É É ì Ò Ù Ü " \\ / +)*														
enumeration	3														
enumeration	3A														
enumeration	3B														
enumeration	3P														
enumeration	3T														
source	<pre><xs:simpleType name="Serie_Registrazione_Contratto_Type"> <xs:restriction base="cm:DatoAN_Type"> <xs:enumeration value="3"/> <xs:enumeration value="3A"/> <xs:enumeration value="3B"/> <xs:enumeration value="3P"/> <xs:enumeration value="3T"/> </xs:restriction> </xs:simpleType></pre>														

simpleType Stato_Civile_Coniuge_Type

namespace	urn:www.agenziaentrate.gov.it:specificheTecniche:sco:730								
type	restriction of DatoNP_Type								
facets	<table border="1"> <thead> <tr> <th>Kind</th> <th>Value</th> </tr> </thead> <tbody> <tr> <td>pattern</td> <td>[1-9]{1}[0-9]*</td> </tr> <tr> <td>enumeration</td> <td>2</td> </tr> <tr> <td>enumeration</td> <td>4</td> </tr> </tbody> </table>	Kind	Value	pattern	[1-9]{1}[0-9]*	enumeration	2	enumeration	4
Kind	Value								
pattern	[1-9]{1}[0-9]*								
enumeration	2								
enumeration	4								
source	<pre><xs:simpleType name="Stato_Civile_Coniuge_Type"></pre>								

	<pre> <xs:restriction base="cm:DatoNP_Type"> <xs:enumeration value="2"/> <xs:enumeration value="4"/> </xs:restriction> </xs:simpleType> </pre>
--	--

simpleType **Stato_Civile_Type**

namespace	urn:www.agenziaentrate.gov.it:specificheTecniche:sco:730								
type	restriction of DatoNP_Type								
facets	<table border="1"> <thead> <tr> <th>Kind</th> <th>Value</th> </tr> </thead> <tbody> <tr> <td>pattern</td> <td>[1-9]{1}[0-9]*</td> </tr> <tr> <td>enumeration</td> <td>7</td> </tr> <tr> <td>enumeration</td> <td>8</td> </tr> </tbody> </table>	Kind	Value	pattern	[1-9]{1}[0-9]*	enumeration	7	enumeration	8
Kind	Value								
pattern	[1-9]{1}[0-9]*								
enumeration	7								
enumeration	8								
source	<pre> <xs:simpleType name="Stato_Civile_Type"> <xs:restriction base="cm:DatoNP_Type"> <xs:enumeration value="7"/> <xs:enumeration value="8"/> </xs:restriction> </xs:simpleType> </pre>								

simpleType **Terreni_Urbano_Type**

namespace	urn:www.agenziaentrate.gov.it:specificheTecniche:sco:730								
type	restriction of DatoAN_Type								
facets	<table border="1"> <thead> <tr> <th>Kind</th> <th>Value</th> </tr> </thead> <tbody> <tr> <td>pattern</td> <td>(([0-9A-Z-]]&quot;){1}([0-9A-Z&amp;]] [- \. , / ^ \(\) À É È Ì Ò Ù Ü &quot; \ \ +)*</td> </tr> <tr> <td>enumeration</td> <td>T</td> </tr> <tr> <td>enumeration</td> <td>U</td> </tr> </tbody> </table>	Kind	Value	pattern	(([0-9A-Z-]]"){1}([0-9A-Z&]] [- \. , / ^ \(\) À É È Ì Ò Ù Ü " \ \ +)*	enumeration	T	enumeration	U
Kind	Value								
pattern	(([0-9A-Z-]]"){1}([0-9A-Z&]] [- \. , / ^ \(\) À É È Ì Ò Ù Ü " \ \ +)*								
enumeration	T								
enumeration	U								
source	<pre> <xs:simpleType name="Terreni_Urbano_Type"> <xs:restriction base="cm:DatoAN_Type"> <xs:enumeration value="T"/> <xs:enumeration value="U"/> </xs:restriction> </xs:simpleType> </pre>								

simpleType **Tipo_Fornitore_730_Type**

namespace	urn:www.agenziaentrate.gov.it:specificheTecniche:sco:730														
type	restriction of DatoNP_Type														
facets	<table border="1"> <thead> <tr> <th>Kind</th> <th>Value</th> </tr> </thead> <tbody> <tr> <td>pattern</td> <td>[1-9]{1}[0-9]*</td> </tr> <tr> <td>enumeration</td> <td>1</td> </tr> <tr> <td>enumeration</td> <td>3</td> </tr> <tr> <td>enumeration</td> <td>5</td> </tr> <tr> <td>enumeration</td> <td>6</td> </tr> <tr> <td>enumeration</td> <td>10</td> </tr> </tbody> </table>	Kind	Value	pattern	[1-9]{1}[0-9]*	enumeration	1	enumeration	3	enumeration	5	enumeration	6	enumeration	10
Kind	Value														
pattern	[1-9]{1}[0-9]*														
enumeration	1														
enumeration	3														
enumeration	5														
enumeration	6														
enumeration	10														
source	<pre> <xs:simpleType name="Tipo_Fornitore_730_Type"> <xs:restriction base="cm:DatoNP_Type"> <xs:enumeration value="1"/> <xs:enumeration value="3"/> <xs:enumeration value="5"/> <xs:enumeration value="6"/> <xs:enumeration value="10"/> </xs:restriction> </xs:simpleType> </pre>														

simpleType **Tipo_Inquilino_Type**

namespace	urn:www.agenziaentrate.gov.it:specificheTecniche:sco:730
-----------	--

type	restriction of DatoNP_Type												
facets	<table border="1"> <thead> <tr> <th>Kind</th> <th>Value</th> </tr> </thead> <tbody> <tr> <td>pattern</td> <td>[1-9]{1}[0-9]*</td> </tr> <tr> <td>enumeration</td> <td>1</td> </tr> <tr> <td>enumeration</td> <td>2</td> </tr> <tr> <td>enumeration</td> <td>3</td> </tr> <tr> <td>enumeration</td> <td>4</td> </tr> </tbody> </table>	Kind	Value	pattern	[1-9]{1}[0-9]*	enumeration	1	enumeration	2	enumeration	3	enumeration	4
Kind	Value												
pattern	[1-9]{1}[0-9]*												
enumeration	1												
enumeration	2												
enumeration	3												
enumeration	4												
source	<pre><xs:simpleType name="Tipo_Inquilino_Type"> <xs:restriction base="cm:DatoNP_Type"> <xs:enumeration value="1"/> <xs:enumeration value="2"/> <xs:enumeration value="3"/> <xs:enumeration value="4"/> </xs:restriction> </xs:simpleType></pre>												

simpleType [Tipo_Intervento_Type](#)

namespace	urn:www.agenziaentrate.gov.it:specificheTecniche:sco:730												
type	restriction of DatoN1_Type												
facets	<table border="1"> <thead> <tr> <th>Kind</th> <th>Value</th> </tr> </thead> <tbody> <tr> <td>pattern</td> <td>[1-9]</td> </tr> <tr> <td>enumeration</td> <td>1</td> </tr> <tr> <td>enumeration</td> <td>2</td> </tr> <tr> <td>enumeration</td> <td>3</td> </tr> <tr> <td>enumeration</td> <td>4</td> </tr> </tbody> </table>	Kind	Value	pattern	[1-9]	enumeration	1	enumeration	2	enumeration	3	enumeration	4
Kind	Value												
pattern	[1-9]												
enumeration	1												
enumeration	2												
enumeration	3												
enumeration	4												
source	<pre><xs:simpleType name="Tipo_Intervento_Type"> <xs:restriction base="cm:DatoN1_Type"> <xs:enumeration value="1"/> <xs:enumeration value="2"/> <xs:enumeration value="3"/> <xs:enumeration value="4"/> </xs:restriction> </xs:simpleType></pre>												

simpleType [Tipo_Reddito_Da1a12_Type](#)

namespace	urn:www.agenziaentrate.gov.it:specificheTecniche:sco:730																												
type	restriction of DatoNP_Type																												
facets	<table border="1"> <thead> <tr> <th>Kind</th> <th>Value</th> </tr> </thead> <tbody> <tr> <td>pattern</td> <td>[1-9]{1}[0-9]*</td> </tr> <tr> <td>enumeration</td> <td>1</td> </tr> <tr> <td>enumeration</td> <td>2</td> </tr> <tr> <td>enumeration</td> <td>3</td> </tr> <tr> <td>enumeration</td> <td>4</td> </tr> <tr> <td>enumeration</td> <td>5</td> </tr> <tr> <td>enumeration</td> <td>6</td> </tr> <tr> <td>enumeration</td> <td>7</td> </tr> <tr> <td>enumeration</td> <td>8</td> </tr> <tr> <td>enumeration</td> <td>9</td> </tr> <tr> <td>enumeration</td> <td>10</td> </tr> <tr> <td>enumeration</td> <td>11</td> </tr> <tr> <td>enumeration</td> <td>12</td> </tr> </tbody> </table>	Kind	Value	pattern	[1-9]{1}[0-9]*	enumeration	1	enumeration	2	enumeration	3	enumeration	4	enumeration	5	enumeration	6	enumeration	7	enumeration	8	enumeration	9	enumeration	10	enumeration	11	enumeration	12
Kind	Value																												
pattern	[1-9]{1}[0-9]*																												
enumeration	1																												
enumeration	2																												
enumeration	3																												
enumeration	4																												
enumeration	5																												
enumeration	6																												
enumeration	7																												
enumeration	8																												
enumeration	9																												
enumeration	10																												
enumeration	11																												
enumeration	12																												
source	<pre><xs:simpleType name="Tipo_Reddito_Da1a12_Type"> <xs:restriction base="cm:DatoNP_Type"> <xs:maxLength value="2"/> <xs:enumeration value="1"/> <xs:enumeration value="2"/> <xs:enumeration value="3"/> <xs:enumeration value="4"/> <xs:enumeration value="5"/> <xs:enumeration value="6"/> <xs:enumeration value="7"/> </xs:restriction> </xs:simpleType></pre>																												

	<pre> <xs:enumeration value="8"/> <xs:enumeration value="9"/> <xs:enumeration value="10"/> <xs:enumeration value="11"/> <xs:enumeration value="12"/> </xs:restriction> </xs:simpleType> </pre>
--	--

simpleType Tipo_Reddito_Da1a3_Type

namespace	urn:www.agenziaentrate.gov.it:specificheTecniche:sco:730										
type	restriction of DatoN1_Type										
facets	<table border="1"> <thead> <tr> <th>Kind</th> <th>Value</th> </tr> </thead> <tbody> <tr> <td>pattern</td> <td>[1-9]</td> </tr> <tr> <td>enumeration</td> <td>1</td> </tr> <tr> <td>enumeration</td> <td>2</td> </tr> <tr> <td>enumeration</td> <td>3</td> </tr> </tbody> </table>	Kind	Value	pattern	[1-9]	enumeration	1	enumeration	2	enumeration	3
Kind	Value										
pattern	[1-9]										
enumeration	1										
enumeration	2										
enumeration	3										
source	<pre> <xs:simpleType name="Tipo_Reddito_Da1a3_Type"> <xs:restriction base="cm:DatoN1_Type"> <xs:enumeration value="1"/> <xs:enumeration value="2"/> <xs:enumeration value="3"/> </xs:restriction> </xs:simpleType> </pre>										

simpleType Tipo_Reddito_Da1a4_Type

namespace	urn:www.agenziaentrate.gov.it:specificheTecniche:sco:730												
type	restriction of DatoN1_Type												
facets	<table border="1"> <thead> <tr> <th>Kind</th> <th>Value</th> </tr> </thead> <tbody> <tr> <td>pattern</td> <td>[1-9]</td> </tr> <tr> <td>enumeration</td> <td>1</td> </tr> <tr> <td>enumeration</td> <td>2</td> </tr> <tr> <td>enumeration</td> <td>3</td> </tr> <tr> <td>enumeration</td> <td>4</td> </tr> </tbody> </table>	Kind	Value	pattern	[1-9]	enumeration	1	enumeration	2	enumeration	3	enumeration	4
Kind	Value												
pattern	[1-9]												
enumeration	1												
enumeration	2												
enumeration	3												
enumeration	4												
source	<pre> <xs:simpleType name="Tipo_Reddito_Da1a4_Type"> <xs:restriction base="cm:DatoN1_Type"> <xs:enumeration value="1"/> <xs:enumeration value="2"/> <xs:enumeration value="3"/> <xs:enumeration value="4"/> </xs:restriction> </xs:simpleType> </pre>												

simpleType Tipo_Reddito_Da1a6_Type

namespace	urn:www.agenziaentrate.gov.it:specificheTecniche:sco:730																
type	restriction of DatoN1_Type																
facets	<table border="1"> <thead> <tr> <th>Kind</th> <th>Value</th> </tr> </thead> <tbody> <tr> <td>pattern</td> <td>[1-9]</td> </tr> <tr> <td>enumeration</td> <td>1</td> </tr> <tr> <td>enumeration</td> <td>2</td> </tr> <tr> <td>enumeration</td> <td>3</td> </tr> <tr> <td>enumeration</td> <td>4</td> </tr> <tr> <td>enumeration</td> <td>5</td> </tr> <tr> <td>enumeration</td> <td>6</td> </tr> </tbody> </table>	Kind	Value	pattern	[1-9]	enumeration	1	enumeration	2	enumeration	3	enumeration	4	enumeration	5	enumeration	6
Kind	Value																
pattern	[1-9]																
enumeration	1																
enumeration	2																
enumeration	3																
enumeration	4																
enumeration	5																
enumeration	6																
source	<pre> <xs:simpleType name="Tipo_Reddito_Da1a6_Type" final=""> <xs:restriction base="cm:DatoN1_Type"> <xs:enumeration value="1"/> <xs:enumeration value="2"/> <xs:enumeration value="3"/> <xs:enumeration value="4"/> </pre>																

	<pre><xs:enumeration value="5"/> <xs:enumeration value="6"/> </xs:restriction> </xs:simpleType></pre>
--	---

simpleType **Tipo_Reddito_Da1a7_Type**

namespace	urn:www.agenziaentrate.gov.it:specificheTecniche:sco:730																		
type	restriction of DatoN1_Type																		
facets	<table border="1"> <thead> <tr> <th>Kind</th> <th>Value</th> </tr> </thead> <tbody> <tr> <td>pattern</td> <td>[1-9]</td> </tr> <tr> <td>enumeration</td> <td>1</td> </tr> <tr> <td>enumeration</td> <td>2</td> </tr> <tr> <td>enumeration</td> <td>3</td> </tr> <tr> <td>enumeration</td> <td>4</td> </tr> <tr> <td>enumeration</td> <td>5</td> </tr> <tr> <td>enumeration</td> <td>6</td> </tr> <tr> <td>enumeration</td> <td>7</td> </tr> </tbody> </table>	Kind	Value	pattern	[1-9]	enumeration	1	enumeration	2	enumeration	3	enumeration	4	enumeration	5	enumeration	6	enumeration	7
Kind	Value																		
pattern	[1-9]																		
enumeration	1																		
enumeration	2																		
enumeration	3																		
enumeration	4																		
enumeration	5																		
enumeration	6																		
enumeration	7																		
source	<pre><xs:simpleType name="Tipo_Reddito_Da1a7_Type"> <xs:restriction base="cm:DatoN1_Type"> <xs:enumeration value="1"/> <xs:enumeration value="2"/> <xs:enumeration value="3"/> <xs:enumeration value="4"/> <xs:enumeration value="5"/> <xs:enumeration value="6"/> <xs:enumeration value="7"/> </xs:restriction> </xs:simpleType></pre>																		

simpleType **Tipo_Reddito_Da1a8_Type**

namespace	urn:www.agenziaentrate.gov.it:specificheTecniche:sco:730																				
type	restriction of DatoNP_Type																				
facets	<table border="1"> <thead> <tr> <th>Kind</th> <th>Value</th> </tr> </thead> <tbody> <tr> <td>pattern</td> <td>[1-9]{1}[0-9]*</td> </tr> <tr> <td>enumeration</td> <td>1</td> </tr> <tr> <td>enumeration</td> <td>2</td> </tr> <tr> <td>enumeration</td> <td>3</td> </tr> <tr> <td>enumeration</td> <td>4</td> </tr> <tr> <td>enumeration</td> <td>5</td> </tr> <tr> <td>enumeration</td> <td>6</td> </tr> <tr> <td>enumeration</td> <td>7</td> </tr> <tr> <td>enumeration</td> <td>8</td> </tr> </tbody> </table>	Kind	Value	pattern	[1-9]{1}[0-9]*	enumeration	1	enumeration	2	enumeration	3	enumeration	4	enumeration	5	enumeration	6	enumeration	7	enumeration	8
Kind	Value																				
pattern	[1-9]{1}[0-9]*																				
enumeration	1																				
enumeration	2																				
enumeration	3																				
enumeration	4																				
enumeration	5																				
enumeration	6																				
enumeration	7																				
enumeration	8																				
source	<pre><xs:simpleType name="Tipo_Reddito_Da1a8_Type"> <xs:restriction base="cm:DatoNP_Type"> <xs:maxLength value="2"/> <xs:enumeration value="1"/> <xs:enumeration value="2"/> <xs:enumeration value="3"/> <xs:enumeration value="4"/> <xs:enumeration value="5"/> <xs:enumeration value="6"/> <xs:enumeration value="7"/> <xs:enumeration value="8"/> </xs:restriction> </xs:simpleType></pre>																				

simpleType **Tipo_Reddito_Da1a9_Type**

namespace	urn:www.agenziaentrate.gov.it:specificheTecniche:sco:730
type	restriction of DatoNP_Type

facets	<table border="1"> <thead> <tr> <th>Kind</th> <th>Value</th> </tr> </thead> <tbody> <tr> <td>pattern</td> <td>[1-9]{1}[0-9]*</td> </tr> <tr> <td>enumeration</td> <td>1</td> </tr> <tr> <td>enumeration</td> <td>2</td> </tr> <tr> <td>enumeration</td> <td>3</td> </tr> <tr> <td>enumeration</td> <td>4</td> </tr> <tr> <td>enumeration</td> <td>5</td> </tr> <tr> <td>enumeration</td> <td>6</td> </tr> <tr> <td>enumeration</td> <td>7</td> </tr> <tr> <td>enumeration</td> <td>8</td> </tr> <tr> <td>enumeration</td> <td>9</td> </tr> </tbody> </table>	Kind	Value	pattern	[1-9]{1}[0-9]*	enumeration	1	enumeration	2	enumeration	3	enumeration	4	enumeration	5	enumeration	6	enumeration	7	enumeration	8	enumeration	9
Kind	Value																						
pattern	[1-9]{1}[0-9]*																						
enumeration	1																						
enumeration	2																						
enumeration	3																						
enumeration	4																						
enumeration	5																						
enumeration	6																						
enumeration	7																						
enumeration	8																						
enumeration	9																						
source	<pre><xs:simpleType name="Tipo_Reddito_Da1a9_Type"> <xs:restriction base="cm:DatoNP_Type"> <xs:maxLength value="2"/> <xs:enumeration value="1"/> <xs:enumeration value="2"/> <xs:enumeration value="3"/> <xs:enumeration value="4"/> <xs:enumeration value="5"/> <xs:enumeration value="6"/> <xs:enumeration value="7"/> <xs:enumeration value="8"/> <xs:enumeration value="9"/> </xs:restriction> </xs:simpleType></pre>																						

simpleType **Tipologia_Soggetto_AssFisc_Type**

namespace	urn:www.agenziaentrate.gov.it:specificheTecniche:sco:730														
type	restriction of DatoN1_Type														
facets	<table border="1"> <thead> <tr> <th>Kind</th> <th>Value</th> </tr> </thead> <tbody> <tr> <td>pattern</td> <td>[1-9]</td> </tr> <tr> <td>enumeration</td> <td>1</td> </tr> <tr> <td>enumeration</td> <td>2</td> </tr> <tr> <td>enumeration</td> <td>3</td> </tr> <tr> <td>enumeration</td> <td>4</td> </tr> <tr> <td>enumeration</td> <td>5</td> </tr> </tbody> </table>	Kind	Value	pattern	[1-9]	enumeration	1	enumeration	2	enumeration	3	enumeration	4	enumeration	5
Kind	Value														
pattern	[1-9]														
enumeration	1														
enumeration	2														
enumeration	3														
enumeration	4														
enumeration	5														
source	<pre><xs:simpleType name="Tipologia_Soggetto_AssFisc_Type"> <xs:restriction base="cm:DatoN1_Type"> <xs:enumeration value="1"/> <xs:enumeration value="2"/> <xs:enumeration value="3"/> <xs:enumeration value="4"/> <xs:enumeration value="5"/> </xs:restriction> </xs:simpleType></pre>														

simpleType **TitoloTerreno_Type**

namespace	urn:www.agenziaentrate.gov.it:specificheTecniche:sco:730																				
type	restriction of DatoNP_Type																				
facets	<table border="1"> <thead> <tr> <th>Kind</th> <th>Value</th> </tr> </thead> <tbody> <tr> <td>pattern</td> <td>[1-9]{1}[0-9]*</td> </tr> <tr> <td>enumeration</td> <td>1</td> </tr> <tr> <td>enumeration</td> <td>2</td> </tr> <tr> <td>enumeration</td> <td>3</td> </tr> <tr> <td>enumeration</td> <td>4</td> </tr> <tr> <td>enumeration</td> <td>5</td> </tr> <tr> <td>enumeration</td> <td>6</td> </tr> <tr> <td>enumeration</td> <td>7</td> </tr> <tr> <td>enumeration</td> <td>10</td> </tr> </tbody> </table>	Kind	Value	pattern	[1-9]{1}[0-9]*	enumeration	1	enumeration	2	enumeration	3	enumeration	4	enumeration	5	enumeration	6	enumeration	7	enumeration	10
Kind	Value																				
pattern	[1-9]{1}[0-9]*																				
enumeration	1																				
enumeration	2																				
enumeration	3																				
enumeration	4																				
enumeration	5																				
enumeration	6																				
enumeration	7																				
enumeration	10																				
source	<pre><xs:simpleType name="TitoloTerreno_Type"> <xs:restriction base="cm:DatoNP_Type"> <xs:enumeration value="1"/> </xs:restriction> </xs:simpleType></pre>																				

	<pre> <xs:enumeration value="2"/> <xs:enumeration value="3"/> <xs:enumeration value="4"/> <xs:enumeration value="5"/> <xs:enumeration value="6"/> <xs:enumeration value="7"/> <xs:enumeration value="10"/> </xs:restriction> </xs:simpleType> </pre>
--	--

simpleType **Utilizzo_Fabbricato_Type**

namespace	urn:www.agenziaentrate.gov.it:specificheTecniche:sco:730																																
type	restriction of DatoNP_Type																																
facets	<table border="1"> <thead> <tr> <th>Kind</th> <th>Value</th> </tr> </thead> <tbody> <tr> <td>pattern</td> <td>[1-9]{1}[0-9]*</td> </tr> <tr> <td>enumeration</td> <td>1</td> </tr> <tr> <td>enumeration</td> <td>2</td> </tr> <tr> <td>enumeration</td> <td>3</td> </tr> <tr> <td>enumeration</td> <td>4</td> </tr> <tr> <td>enumeration</td> <td>5</td> </tr> <tr> <td>enumeration</td> <td>8</td> </tr> <tr> <td>enumeration</td> <td>9</td> </tr> <tr> <td>enumeration</td> <td>10</td> </tr> <tr> <td>enumeration</td> <td>11</td> </tr> <tr> <td>enumeration</td> <td>12</td> </tr> <tr> <td>enumeration</td> <td>14</td> </tr> <tr> <td>enumeration</td> <td>15</td> </tr> <tr> <td>enumeration</td> <td>16</td> </tr> <tr> <td>enumeration</td> <td>17</td> </tr> </tbody> </table>	Kind	Value	pattern	[1-9]{1}[0-9]*	enumeration	1	enumeration	2	enumeration	3	enumeration	4	enumeration	5	enumeration	8	enumeration	9	enumeration	10	enumeration	11	enumeration	12	enumeration	14	enumeration	15	enumeration	16	enumeration	17
Kind	Value																																
pattern	[1-9]{1}[0-9]*																																
enumeration	1																																
enumeration	2																																
enumeration	3																																
enumeration	4																																
enumeration	5																																
enumeration	8																																
enumeration	9																																
enumeration	10																																
enumeration	11																																
enumeration	12																																
enumeration	14																																
enumeration	15																																
enumeration	16																																
enumeration	17																																
source	<pre> <xs:simpleType name="Utilizzo_Fabbricato_Type"> <xs:restriction base="cm:DatoNP_Type"> <xs:minLength value="1"/> <xs:maxLength value="2"/> <xs:enumeration value="1"/> <xs:enumeration value="2"/> <xs:enumeration value="3"/> <xs:enumeration value="4"/> <xs:enumeration value="5"/> <xs:enumeration value="8"/> <xs:enumeration value="9"/> <xs:enumeration value="10"/> <xs:enumeration value="11"/> <xs:enumeration value="12"/> <xs:enumeration value="14"/> <xs:enumeration value="15"/> <xs:enumeration value="16"/> <xs:enumeration value="17"/> </xs:restriction> </xs:simpleType> </pre>																																

element **Documento**

diagram	<pre> classDiagram class Documento_Type { attributes identificativo } class Documento Documento_Type < -- Documento </pre>
namespace	urn:www.agenziaentrate.gov.it:specificheTecniche:common

type	Documento_Type				
attributes	Name identificativo	Type Identificativo_Type	Use required	Default	Fixed
source	<code><xs:element name="Documento" type="Documento_Type" abstract="true"/></code>				

complexType [Documento_Type](#)

diagram					
namespace	urn:www.agenziaentrate.gov.it:specificheTecniche:common				
attributes	Name identificativo	Type Identificativo_Type	Use required	Default	Fixed
source	<pre> <xs:complexType name="Documento_Type"> <xs:annotation> <xs:documentation xml:lang="it">Documento trasmesso</xs:documentation> </xs:annotation> <xs:attribute name="identificativo" type="Identificativo_Type" use="required"/> </xs:complexType> </pre>				

attribute [Documento_Type/@identificativo](#)

type	Identificativo_Type				
facets	Kind	Value			
	pattern	[0-9]{4}[1-9][0-9]{3}[1-9][0-9][0-9]{2}[1-9][0-9]{2}[0-9][1-9][0-9]{3}[1-9][0-9]{4}			
source	<code><xs:attribute name="identificativo" type="Identificativo_Type" use="required"/></code>				

simpleType [Identificativo_Type](#)

namespace	urn:www.agenziaentrate.gov.it:specificheTecniche:common				
type	restriction of xs:string				
facets	Kind	Value			
	pattern	[0-9]{4}[1-9][0-9]{3}[1-9][0-9][0-9]{2}[1-9][0-9]{2}[0-9][1-9][0-9]{3}[1-9][0-9]{4}			
source	<pre> <xs:simpleType name="Identificativo_Type"> <xs:restriction base="xs:string"> <xs:pattern value="[0-9]{4}[1-9][0-9]{3}[1-9][0-9][0-9]{2}[1-9][0-9]{2}[0-9][1-9][0-9]{3}[1-9][0-9]{4}" /> </xs:restriction> </xs:simpleType> </pre>				

complexType **Dati_Anagrafici_Type**

diagram	
namespace	urn:www.agenziaentrare.gov.it:specificheTecniche:sco:common
children	Cognome Nome Sesso DataNascita ComuneNascita ProvinciaNascita
source	<pre><xs:complexType name="Dati_Anagrafici_Type"> <xs:sequence> <xs:element name="Cognome" type="cm:DatoAN_Type"/> <xs:element name="Nome" type="cm:DatoAN_Type"/> <xs:element name="Sesso" type="Sesso_Type"/> <xs:element name="DataNascita" type="cm:DatoDT_Type"/> <xs:element name="ComuneNascita" type="cm:DatoAN_Type"/> <xs:element name="ProvinciaNascita" type="cm:PN_Type" minOccurs="0"/> </xs:sequence> </xs:complexType></pre>

element **Dati_Anagrafici_Type/Cognome**

diagram					
namespace	urn:www.agenziaentrare.gov.it:specificheTecniche:sco:common				
type	DatoAN_Type				
facets	<table border="1"> <thead> <tr> <th>Kind</th> <th>Value</th> </tr> </thead> <tbody> <tr> <td>pattern</td> <td>(([0-9A-Z-] &quot;){1}([0-9A-Z&amp;] ' \" \\. / ° \\^\\(\\) À É È Ì Ò Ù Û &quot; \\ \\ \\ +)*</td> </tr> </tbody> </table>	Kind	Value	pattern	(([0-9A-Z-] "){1}([0-9A-Z&] ' \" \\. / ° \\^\\(\\) À É È Ì Ò Ù Û " \\ \\ \\ +)*
Kind	Value				
pattern	(([0-9A-Z-] "){1}([0-9A-Z&] ' \" \\. / ° \\^\\(\\) À É È Ì Ò Ù Û " \\ \\ \\ +)*				
source	<pre><xs:element name="Cognome" type="cm:DatoAN_Type"/></pre>				

element **Dati_Anagrafici_Type/Nome**

diagram					
namespace	urn:www.agenziaentrare.gov.it:specificheTecniche:sco:common				
type	DatoAN_Type				
facets	<table border="1"> <thead> <tr> <th>Kind</th> <th>Value</th> </tr> </thead> <tbody> <tr> <td>pattern</td> <td>(([0-9A-Z-] &quot;){1}([0-9A-Z&amp;] ' \" \\. / ° \\^\\(\\) À É È Ì Ò Ù Û &quot; \\ \\ \\ +)*</td> </tr> </tbody> </table>	Kind	Value	pattern	(([0-9A-Z-] "){1}([0-9A-Z&] ' \" \\. / ° \\^\\(\\) À É È Ì Ò Ù Û " \\ \\ \\ +)*
Kind	Value				
pattern	(([0-9A-Z-] "){1}([0-9A-Z&] ' \" \\. / ° \\^\\(\\) À É È Ì Ò Ù Û " \\ \\ \\ +)*				
source	<pre><xs:element name="Nome" type="cm:DatoAN_Type"/></pre>				

element **Dati_Anagrafici_Type/Sesso**

diagram	
namespace	urn:www.agenziaentrare.gov.it:specificheTecniche:sco:common

type	Sesso_Type								
facets	<table border="0"> <tr> <td>Kind</td> <td>Value</td> </tr> <tr> <td>pattern</td> <td>(([0-9A-Z-])&quot;){1}([0-9A-Z&amp;:] \\-\\. , / ^\\(\\) À É È Ì Ò Ù Û &quot; \\ \\+)*</td> </tr> <tr> <td>enumeration</td> <td>M</td> </tr> <tr> <td>enumeration</td> <td>F</td> </tr> </table>	Kind	Value	pattern	(([0-9A-Z-])"){1}([0-9A-Z&:] \\-\\. , / ^\\(\\) À É È Ì Ò Ù Û " \\ \\+)*	enumeration	M	enumeration	F
Kind	Value								
pattern	(([0-9A-Z-])"){1}([0-9A-Z&:] \\-\\. , / ^\\(\\) À É È Ì Ò Ù Û " \\ \\+)*								
enumeration	M								
enumeration	F								
source	<xs:element name="Sesso" type="Sesso_Type"/>								

element **Dati_Anagrafici_Type/DataNascita**

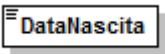
diagram					
namespace	urn:www.agenziaentrate.gov.it:specificheTecniche:sco:common				
type	DatoDT_Type				
facets	<table border="0"> <tr> <td>Kind</td> <td>Value</td> </tr> <tr> <td>pattern</td> <td>((([0-9][1-9][12][0-9][3][01])(0[13578][10]12)\\d{4}))((([0][1-9][12][0-9][30](0[469][11)\\d{4}))((([0][1-9][1][0-9][2][0-8][02)\\d{4}))((29)(02)([02468][048]00))((29)(02)([13579][26]00))((29)(02)([0-9][0-9][0][48]))((29)(02)([0-9][0-9][2468][048]))((29)(02)([0-9][0-9][13579][26]))))</td> </tr> </table>	Kind	Value	pattern	((([0-9][1-9][12][0-9][3][01])(0[13578][10]12)\\d{4}))((([0][1-9][12][0-9][30](0[469][11)\\d{4}))((([0][1-9][1][0-9][2][0-8][02)\\d{4}))((29)(02)([02468][048]00))((29)(02)([13579][26]00))((29)(02)([0-9][0-9][0][48]))((29)(02)([0-9][0-9][2468][048]))((29)(02)([0-9][0-9][13579][26]))))
Kind	Value				
pattern	((([0-9][1-9][12][0-9][3][01])(0[13578][10]12)\\d{4}))((([0][1-9][12][0-9][30](0[469][11)\\d{4}))((([0][1-9][1][0-9][2][0-8][02)\\d{4}))((29)(02)([02468][048]00))((29)(02)([13579][26]00))((29)(02)([0-9][0-9][0][48]))((29)(02)([0-9][0-9][2468][048]))((29)(02)([0-9][0-9][13579][26]))))				
source	<xs:element name="DataNascita" type="cm:DatoDT_Type"/>				

element **Dati_Anagrafici_Type/ComuneNascita**

diagram					
namespace	urn:www.agenziaentrate.gov.it:specificheTecniche:sco:common				
type	DatoAN_Type				
facets	<table border="0"> <tr> <td>Kind</td> <td>Value</td> </tr> <tr> <td>pattern</td> <td>(([0-9A-Z-])&quot;){1}([0-9A-Z&amp;:] \\-\\. , / ^\\(\\) À É È Ì Ò Ù Û &quot; \\ \\+)*</td> </tr> </table>	Kind	Value	pattern	(([0-9A-Z-])"){1}([0-9A-Z&:] \\-\\. , / ^\\(\\) À É È Ì Ò Ù Û " \\ \\+)*
Kind	Value				
pattern	(([0-9A-Z-])"){1}([0-9A-Z&:] \\-\\. , / ^\\(\\) À É È Ì Ò Ù Û " \\ \\+)*				
source	<xs:element name="ComuneNascita" type="cm:DatoAN_Type"/>				

element **Dati_Anagrafici_Type/ProvinciaNascita**

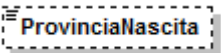
diagram	
namespace	urn:www.agenziaentrate.gov.it:specificheTecniche:sco:common
type	PN_Type
source	<xs:element name="ProvinciaNascita" type="cm:PN_Type" minOccurs="0"/>

complexType **Dati_Sottoscrittore_Type**

diagram	
namespace	urn:www.agenziaentrate.gov.it:specificheTecniche:sco:common
children	CodiceFiscale CodiceCarica CodiceFiscaleSocieta DatiAnagrafici ResidenzaEstera Telefono DataCarica InizioProcedura ProceduraNonTerminata FineProcedura
source	<pre><xs:complexType name="Dati_Sottoscrittore_Type"> <xs:sequence> <xs:element name="CodiceFiscale" type="cm:DatoCF_Type"/> <xs:element name="CodiceCarica" type="cm:Codice_Carica_Type"/> <xs:element name="CodiceFiscaleSocieta" type="cm:DatoCN_Type" minOccurs="0"/> <xs:element name="DatiAnagrafici" type="Dati_Anagrafici_Type"/> <xs:element name="ResidenzaEstera" type="Residenza_Estera_Type" minOccurs="0"/> <xs:element name="Telefono" type="cm:DatoTL_Type" minOccurs="0"/> <xs:element name="DataCarica" type="cm:DatoDT_Type" minOccurs="0"/> <xs:element name="InizioProcedura" type="cm:DatoDT_Type" minOccurs="0"/> <xs:element name="ProceduraNonTerminata" type="cm:DatoCB_Type" minOccurs="0"/> <xs:element name="FineProcedura" type="cm:DatoDT_Type" minOccurs="0"/> </xs:sequence> </xs:complexType></pre>

element **Dati_Sottoscrittore_Type/CodiceFiscale**

diagram					
namespace	urn:www.agenziaentrate.gov.it:specificheTecniche:sco:common				
type	DatoCF_Type				
facets	<table border="1"> <thead> <tr> <th>Kind</th> <th>Value</th> </tr> </thead> <tbody> <tr> <td>pattern</td> <td>[0-9]{11}[A-Z]{6}[0-9LMNPQRSTUVWXYZ]{2}[A-Z]{1}[0-9LMNPQRSTUVWXYZ]{2}[A-Z]{1}[0-9LMNPQRSTUVWXYZ]{3}[A-Z]{1}</td> </tr> </tbody> </table>	Kind	Value	pattern	[0-9]{11}[A-Z]{6}[0-9LMNPQRSTUVWXYZ]{2}[A-Z]{1}[0-9LMNPQRSTUVWXYZ]{2}[A-Z]{1}[0-9LMNPQRSTUVWXYZ]{3}[A-Z]{1}
Kind	Value				
pattern	[0-9]{11}[A-Z]{6}[0-9LMNPQRSTUVWXYZ]{2}[A-Z]{1}[0-9LMNPQRSTUVWXYZ]{2}[A-Z]{1}[0-9LMNPQRSTUVWXYZ]{3}[A-Z]{1}				
source	<pre><xs:element name="CodiceFiscale" type="cm:DatoCF_Type"/></pre>				

element **Dati_Sottoscrittore_Type/CodiceCarica**

diagram	
---------	--

namespace	urn:www.agenziaentrate.gov.it:specificheTecniche:sco:common																																		
type	Codice Carica Type																																		
facets	<table border="1"> <thead> <tr> <th>Kind</th> <th>Value</th> </tr> </thead> <tbody> <tr> <td>pattern</td> <td>[1-9]{1}[0-9]*</td> </tr> <tr> <td>enumeration</td> <td>1</td> </tr> <tr> <td>enumeration</td> <td>2</td> </tr> <tr> <td>enumeration</td> <td>3</td> </tr> <tr> <td>enumeration</td> <td>4</td> </tr> <tr> <td>enumeration</td> <td>5</td> </tr> <tr> <td>enumeration</td> <td>6</td> </tr> <tr> <td>enumeration</td> <td>7</td> </tr> <tr> <td>enumeration</td> <td>8</td> </tr> <tr> <td>enumeration</td> <td>9</td> </tr> <tr> <td>enumeration</td> <td>10</td> </tr> <tr> <td>enumeration</td> <td>11</td> </tr> <tr> <td>enumeration</td> <td>12</td> </tr> <tr> <td>enumeration</td> <td>13</td> </tr> <tr> <td>enumeration</td> <td>14</td> </tr> <tr> <td>enumeration</td> <td>15</td> </tr> </tbody> </table>	Kind	Value	pattern	[1-9]{1}[0-9]*	enumeration	1	enumeration	2	enumeration	3	enumeration	4	enumeration	5	enumeration	6	enumeration	7	enumeration	8	enumeration	9	enumeration	10	enumeration	11	enumeration	12	enumeration	13	enumeration	14	enumeration	15
Kind	Value																																		
pattern	[1-9]{1}[0-9]*																																		
enumeration	1																																		
enumeration	2																																		
enumeration	3																																		
enumeration	4																																		
enumeration	5																																		
enumeration	6																																		
enumeration	7																																		
enumeration	8																																		
enumeration	9																																		
enumeration	10																																		
enumeration	11																																		
enumeration	12																																		
enumeration	13																																		
enumeration	14																																		
enumeration	15																																		
source	<xs:element name="CodiceCarica" type="Codice_Carica_Type"/>																																		

element **Dati_Sottoscrittore_Type/CodiceFiscaleSocieta**

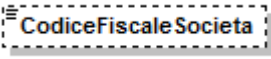
diagram					
namespace	urn:www.agenziaentrate.gov.it:specificheTecniche:sco:common				
type	DatoCN Type				
facets	<table border="1"> <thead> <tr> <th>Kind</th> <th>Value</th> </tr> </thead> <tbody> <tr> <td>pattern</td> <td>[0-9]{11}</td> </tr> </tbody> </table>	Kind	Value	pattern	[0-9]{11}
Kind	Value				
pattern	[0-9]{11}				
source	<xs:element name="CodiceFiscaleSocieta" type="cm:DatoCN_Type" minOccurs="0"/>				

element **Dati_Sottoscrittore_Type/DatiAnagrafici**

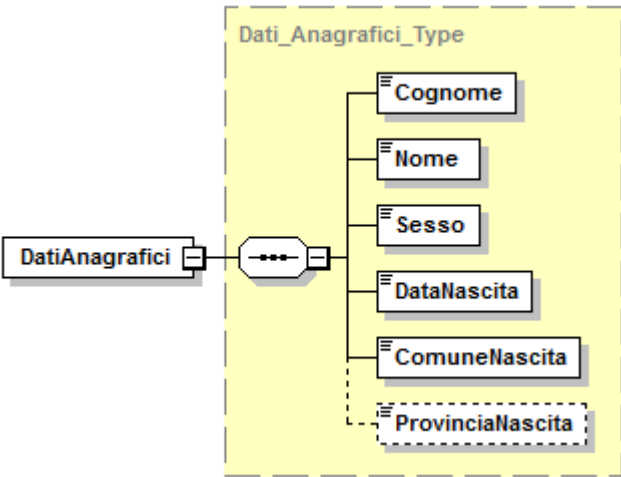
diagram	
namespace	urn:www.agenziaentrate.gov.it:specificheTecniche:sco:common
type	Dati_Anagrafici Type
children	Cognome Nome Sesso DataNascita ComuneNascita ProvinciaNascita
source	<xs:element name="DatiAnagrafici" type="Dati_Anagrafici_Type"/>

	9][2468][048]))((29)(02)([0-9][0-9][13579][26]))
source	<xs:element name="InizioProcedura" type="cm:DatoDT_Type" minOccurs="0"/>

element **Dati_Sottoscrittore_Type/ProceduraNonTerminata**

diagram	
namespace	urn:www.agenziaentrate.gov.it:specificheTecniche:sco:common
type	DatoCB_Type
facets	Kind Value pattern [01]
source	<xs:element name="ProceduraNonTerminata" type="cm:DatoCB_Type" minOccurs="0"/>

element **Dati_Sottoscrittore_Type/FineProcedura**

diagram	
namespace	urn:www.agenziaentrate.gov.it:specificheTecniche:sco:common
type	DatoDT_Type
facets	Kind Value pattern (((([0-9][1-9][12][0-9][3][01])(0[13578][10 12](\d{4}))) ((([0][1-9][12][0-9][30](0[469][11](\d{4}))) ((([0][1-9][1[0-9][2[0-8])(02)(\d{4}))) ((29)(02)([02468][048]00)) ((29)(02)([13579][26]00)) ((29)(02)([0-9][0-9][0][48])) ((29)(02)([0-9][0-9][2468][048])) ((29)(02)([0-9][0-9][13579][26]))))
source	<xs:element name="FineProcedura" type="cm:DatoDT_Type" minOccurs="0"/>

complexType **Domicilio_EE_Type**

diagram	
namespace	urn:www.agenziaentrate.gov.it:specificheTecniche:sco:common
children	Comune Provincia CodiceComune Indirizzo Cap DataVariazione
source	<xs:complexType name="Domicilio_EE_Type"> <xs:sequence> <xs:element name="Comune" type="cm:DatoAN_Type"/> <xs:element name="Provincia" type="cm:PE_Type" minOccurs="0"/> <xs:element name="CodiceComune" type="cm:DatoAN_Type" minOccurs="0"/> <xs:element name="Indirizzo" type="cm:DatoAN_Type" minOccurs="0"/> <xs:element name="Cap" type="cm:DatoCP_Type" minOccurs="0"/> <xs:element name="DataVariazione" type="cm:DatoD6_Type" minOccurs="0"/> </xs:sequence> </xs:complexType>

element **Domicilio_EE_Type/DataVariazione**

diagram	
namespace	urn:www.agenziaentrate.gov.it:specificheTecniche:sco:common
type	DatoD6_Type
facets	Kind Value pattern ((0[0-9])(1[0-2]))((19 20)[0-9][0-9])
source	<code><xs:element name="DataVariazione" type="cm:DatoD6_Type" minOccurs="0"/></code>

complexType **Domicilio_Fiscale_Type**

diagram	
namespace	urn:www.agenziaentrate.gov.it:specificheTecniche:sco:common
type	extension of Domicilio_Ita_Type
children	Comune Provincia CodiceComune Indirizzo Cap DataVariazione
source	<pre><xs:complexType name="Domicilio_Fiscale_Type"> <xs:complexContent> <xs:extension base="Domicilio_Ita_Type"> <xs:sequence> <xs:element name="DataVariazione" type="cm:DatoD6_Type" minOccurs="0"/> </xs:sequence> </xs:extension> </xs:complexContent> </xs:complexType></pre>

element **Domicilio_Fiscale_Type/DataVariazione**

diagram	
namespace	urn:www.agenziaentrate.gov.it:specificheTecniche:sco:common
type	DatoD6_Type
facets	Kind Value pattern ((0[0-9])(1[0-2]))((19 20)[0-9][0-9])
source	<code><xs:element name="DataVariazione" type="cm:DatoD6_Type" minOccurs="0"/></code>

complexType **Domicilio_Ita_Type**

diagram	
namespace	urn:www.agenziaentrate.gov.it:specificheTecniche:sco:common
children	Comune Provincia CodiceComune Indirizzo Cap
source	<pre><xs:complexType name="Domicilio_Ita_Type"> <xs:sequence> <xs:element name="Comune" type="cm:DatoAN_Type"/> <xs:element name="Provincia" type="cm:PR_Type"/> <xs:element name="CodiceComune" type="cm:DatoAN_Type"/> <xs:element name="Indirizzo" type="cm:DatoAN_Type"/> <xs:element name="Cap" type="cm:DatoCP_Type"/> </xs:sequence> </xs:complexType></pre>

element **Domicilio_Ita_Type/Comune**

diagram					
namespace	urn:www.agenziaentrate.gov.it:specificheTecniche:sco:common				
type	DatoAN_Type				
facets	<table border="1"> <thead> <tr> <th>Kind</th> <th>Value</th> </tr> </thead> <tbody> <tr> <td>pattern</td> <td>([0-9A-Z-] \&quot;){1}([0-9A-Z&amp;#39; ! - \., / ° °\°\(\) À É É Ì Ò Ù Û &quot; \ \\ /+)*</td> </tr> </tbody> </table>	Kind	Value	pattern	([0-9A-Z-] \"){1}([0-9A-Z&#39; ! - \., / ° °\°\(\) À É É Ì Ò Ù Û " \ \\ /+)*
Kind	Value				
pattern	([0-9A-Z-] \"){1}([0-9A-Z&#39; ! - \., / ° °\°\(\) À É É Ì Ò Ù Û " \ \\ /+)*				
source	<pre><xs:element name="Comune" type="cm:DatoAN_Type"/></pre>				

element **Domicilio_Ita_Type/Provincia**

diagram	
namespace	urn:www.agenziaentrate.gov.it:specificheTecniche:sco:common
type	PR_Type
source	<pre><xs:element name="Provincia" type="cm:PR_Type"/></pre>

element **Domicilio_Ita_Type/CodiceComune**

diagram					
namespace	urn:www.agenziaentrate.gov.it:specificheTecniche:sco:common				
type	DatoAN_Type				
facets	<table border="1"> <thead> <tr> <th>Kind</th> <th>Value</th> </tr> </thead> <tbody> <tr> <td>pattern</td> <td>([0-9A-Z-] \&quot;){1}([0-9A-Z&amp;#39; ! - \., / ° °\°\(\) À É É Ì Ò Ù Û &quot; \ \\ /+)*</td> </tr> </tbody> </table>	Kind	Value	pattern	([0-9A-Z-] \"){1}([0-9A-Z&#39; ! - \., / ° °\°\(\) À É É Ì Ò Ù Û " \ \\ /+)*
Kind	Value				
pattern	([0-9A-Z-] \"){1}([0-9A-Z&#39; ! - \., / ° °\°\(\) À É É Ì Ò Ù Û " \ \\ /+)*				
source	<pre><xs:element name="CodiceComune" type="cm:DatoAN_Type"/></pre>				

element **Domicilio_Ita_Type/Indirizzo**

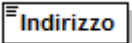
diagram	
namespace	urn:www.agenziaentrate.gov.it:specificheTecniche:sco:common
type	DatoAN_Type
facets	Kind Value pattern <code>(([0-9A-Z-])&quot;){1}([0-9A-Z&amp;:] \\- \\. , ! ° \\^\\(\\ \\) À É Ì Ò Ù &quot; \\ \\ \\+)*</code>
source	<code><xs:element name="Indirizzo" type="cm:DatoAN_Type"/></code>

element **Domicilio_Ita_Type/Cap**

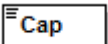
diagram	
namespace	urn:www.agenziaentrate.gov.it:specificheTecniche:sco:common
type	DatoCP_Type
facets	Kind Value pattern <code>[0-9]{5}</code>
source	<code><xs:element name="Cap" type="cm:DatoCP_Type"/></code>

complexType **Firma_Revisione_Type**

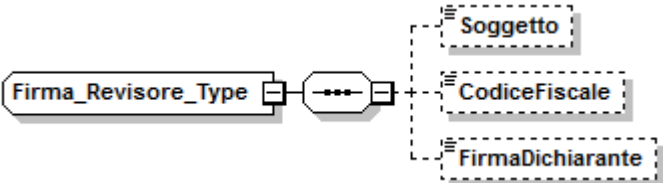
diagram	
namespace	urn:www.agenziaentrate.gov.it:specificheTecniche:sco:common
children	Soggetto CodiceFiscale FirmaDichiarante
source	<pre><xs:complexType name="Firma_Revisione_Type"> <xs:sequence> <xs:element name="Soggetto" minOccurs="0"> <xs:simpleType> <xs:restriction base="cm:DatoNP_Type"> <xs:pattern value="[1-4]"/> </xs:restriction> </xs:simpleType> </xs:element> <xs:element name="CodiceFiscale" type="cm:DatoCF_Type" minOccurs="0"/> <xs:element name="FirmaDichiarante" type="cm:DatoCB_Type" minOccurs="0"/> </xs:sequence> </xs:complexType></pre>

element **Firma_Revisione_Type/Soggetto**

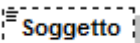
diagram	
namespace	urn:www.agenziaentrate.gov.it:specificheTecniche:sco:common
type	restriction of DatoNP_Type

facets	Kind Value pattern [1-4]
source	<pre><xs:element name="Soggetto" minOccurs="0"> <xs:simpleType> <xs:restriction base="cm:DatoNP_Type"> <xs:pattern value="[1-4]"/> </xs:restriction> </xs:simpleType> </xs:element></pre>

element **Firma_Revisore_Type/CodiceFiscale**

diagram	
namespace	urn:www.agenziaentrate.gov.it:specificheTecniche:sco:common
type	DatoCF_Type
facets	Kind Value pattern [0-9]{11}[A-Z]{6}[0-9LMNPQRSTU]{2}[A-Z]{1}[0-9LMNPQRSTU]{3}[A-Z]{1}
source	<pre><xs:element name="CodiceFiscale" type="cm:DatoCF_Type" minOccurs="0"/></pre>

element **Firma_Revisore_Type/FirmaDichiarante**

diagram	
namespace	urn:www.agenziaentrate.gov.it:specificheTecniche:sco:common
type	DatoCB_Type
facets	Kind Value pattern [01]
source	<pre><xs:element name="FirmaDichiarante" type="cm:DatoCB_Type" minOccurs="0"/></pre>

complexType **Firma_Type**

diagram	
namespace	urn:www.agenziaentrate.gov.it:specificheTecniche:sco:common
children	Firma CodiceFiscale
source	<pre><xs:complexType name="Firma_Type"> <xs:sequence> <xs:element name="Firma" type="cm:DatoCB_Type" minOccurs="0"/> <xs:element name="CodiceFiscale" minOccurs="0"> <xs:simpleType> <xs:restriction base="xs:string"> <xs:pattern value="([0-9A-Z-] ' \" _ . , _ / ° °\ (\)À È É Ì Ò Ù Ü &quot; \\ / +)*"/> </xs:restriction> </xs:simpleType> </xs:element> </xs:sequence> </xs:complexType></pre>

element **Firma_Type/Firma**

diagram					
namespace	urn:www.agenziaentrate.gov.it:specificheTecniche:sco:common				
type	DatoCB_Type				
facets	<table border="1"> <tr> <td>Kind</td> <td>Value</td> </tr> <tr> <td>pattern</td> <td>[01]</td> </tr> </table>	Kind	Value	pattern	[01]
Kind	Value				
pattern	[01]				
source	<code><xs:element name="Firma" type="cm:DatoCB_Type" minOccurs="0"/></code>				

element **Firma_Type/CodiceFiscale**

diagram					
namespace	urn:www.agenziaentrate.gov.it:specificheTecniche:sco:common				
type	restriction of xs:string				
facets	<table border="1"> <tr> <td>Kind</td> <td>Value</td> </tr> <tr> <td>pattern</td> <td>(([0-9A-Z-])&quot;){0,1}([0-9A-Z&amp;#x2D;])?[\-\. \s / ^\\(\\) À È É Ì Ò Ù Û &quot; \N / +)*</td> </tr> </table>	Kind	Value	pattern	(([0-9A-Z-])"){0,1}([0-9A-Z&#x2D;])?[\-\. \s / ^\\(\\) À È É Ì Ò Ù Û " \N / +)*
Kind	Value				
pattern	(([0-9A-Z-])"){0,1}([0-9A-Z&#x2D;])?[\-\. \s / ^\\(\\) À È É Ì Ò Ù Û " \N / +)*				
source	<pre> <xs:element name="CodiceFiscale" minOccurs="0"> <xs:simpleType> <xs:restriction base="xs:string"> <xs:pattern value="(([0-9A-Z-])&quot;){0,1}([0-9A-Z&amp;#x2D;])?[\-\. \s / ^\\(\\) À È É Ì Ò Ù Û &quot; \N / +)*"/> </xs:restriction> </xs:simpleType> </xs:element> </pre>				

complexType **Frontespizio_Type**

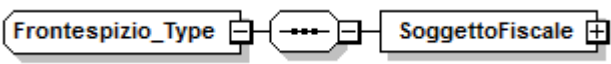
diagram	
namespace	urn:www.agenziaentrate.gov.it:specificheTecniche:sco:common
children	SoggettoFiscale
source	<pre> <xs:complexType name="Frontespizio_Type"> <xs:sequence> <xs:element name="SoggettoFiscale" type="Soggetto_Fiscale_Type"/> </xs:sequence> </xs:complexType> </pre>

element **Frontespizio_Type/SoggettoFiscale**

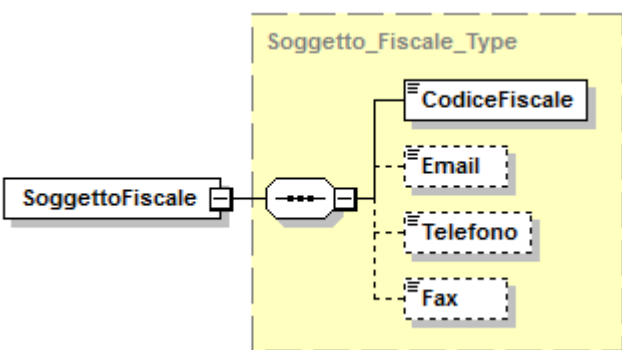
diagram	
namespace	urn:www.agenziaentrate.gov.it:specificheTecniche:sco:common

type	Soggetto Fiscale Type
children	CodiceFiscale Email Telefono Fax
source	<code><xs:element name="SoggettoFiscale" type="Soggetto_Fiscale_Type"/></code>

complexType **Impegno_A_Trasmettere_Type**

diagram	
namespace	urn:www.agenziaentrate.gov.it:specificheTecniche:sco:common
children	CFintermediario NumerolscrAlboCAF ImpegnoATrasmettere RicezioneAvvisoTelem DataImpegno FirmaIntermediario
source	<pre> <xs:complexType name="Impegno_A_Trasmettere_Type"> <xs:sequence> <xs:element name="CFintermediario" type="cm:DatoCF_Type"/> <xs:element name="NumerolscrAlboCAF" minOccurs="0"> <xs:simpleType> <xs:restriction base="cm:DatoNU_Type"> <xs:maxLength value="5"/> </xs:restriction> </xs:simpleType> </xs:element> <xs:element name="ImpegnoATrasmettere"> <xs:simpleType> <xs:restriction base="cm:DatoNP_Type"> <xs:pattern value="1 2"/> <xs:enumeration value="1"/> <xs:enumeration value="2"/> </xs:restriction> </xs:simpleType> </xs:element> <xs:element name="RicezioneAvvisoTelem" type="cm:DatoCB_Type" minOccurs="0"/> <xs:element name="DataImpegno" type="cm:DatoDT_Type"/> <xs:element name="FirmaIntermediario" type="cm:DatoCB_Type"/> </xs:sequence> </xs:complexType> </pre>

element **Impegno_A_Trasmettere_Type/CFintermediario**

diagram					
namespace	urn:www.agenziaentrate.gov.it:specificheTecniche:sco:common				
type	DatoCF_Type				
facets	<table border="1"> <thead> <tr> <th>Kind</th> <th>Value</th> </tr> </thead> <tbody> <tr> <td>pattern</td> <td>[0-9]{11}[A-Z]{6}[0-9LMNPQRSTUUV]{2}[A-Z]{1}[0-9LMNPQRSTUUV]{2}[A-Z]{1}[0-9LMNPQRSTUUV]{3}[A-Z]{1}</td> </tr> </tbody> </table>	Kind	Value	pattern	[0-9]{11}[A-Z]{6}[0-9LMNPQRSTUUV]{2}[A-Z]{1}[0-9LMNPQRSTUUV]{2}[A-Z]{1}[0-9LMNPQRSTUUV]{3}[A-Z]{1}
Kind	Value				
pattern	[0-9]{11}[A-Z]{6}[0-9LMNPQRSTUUV]{2}[A-Z]{1}[0-9LMNPQRSTUUV]{2}[A-Z]{1}[0-9LMNPQRSTUUV]{3}[A-Z]{1}				
source	<code><xs:element name="CFintermediario" type="cm:DatoCF_Type"/></code>				

element **Impegno_A_Trasmettere_Type/NumerolscrAlboCAF**

diagram					
namespace	urn:www.agenziaentrate.gov.it:specificheTecniche:sco:common				
type	restriction of DatoNU_Type				
facets	<table border="1"> <thead> <tr> <th>Kind</th> <th>Value</th> </tr> </thead> <tbody> <tr> <td>pattern</td> <td>(\-[1-9] [1-9])[0-9]*</td> </tr> </tbody> </table>	Kind	Value	pattern	(\-[1-9] [1-9])[0-9]*
Kind	Value				
pattern	(\-[1-9] [1-9])[0-9]*				
source	<pre><xs:element name="NumerolscrAlboCAF" minOccurs="0"> <xs:simpleType> <xs:restriction base="cm:DatoNU_Type"> <xs:maxLength value="5"/> </xs:restriction> </xs:simpleType> </xs:element></pre>				

element **Impegno_A_Trasmettere_Type/ImpegnoATrasmettere**

diagram									
namespace	urn:www.agenziaentrate.gov.it:specificheTecniche:sco:common								
type	restriction of DatoNP_Type								
facets	<table border="1"> <thead> <tr> <th>Kind</th> <th>Value</th> </tr> </thead> <tbody> <tr> <td>pattern</td> <td>1 2</td> </tr> <tr> <td>enumeration</td> <td>1</td> </tr> <tr> <td>enumeration</td> <td>2</td> </tr> </tbody> </table>	Kind	Value	pattern	1 2	enumeration	1	enumeration	2
Kind	Value								
pattern	1 2								
enumeration	1								
enumeration	2								
source	<pre><xs:element name="ImpegnoATrasmettere"> <xs:simpleType> <xs:restriction base="cm:DatoNP_Type"> <xs:pattern value="1 2"/> <xs:enumeration value="1"/> <xs:enumeration value="2"/> </xs:restriction> </xs:simpleType> </xs:element></pre>								

element **Impegno_A_Trasmettere_Type/RicezioneAvvisoTelem**

diagram					
namespace	urn:www.agenziaentrate.gov.it:specificheTecniche:sco:common				
type	DatoCB_Type				
facets	<table border="1"> <thead> <tr> <th>Kind</th> <th>Value</th> </tr> </thead> <tbody> <tr> <td>pattern</td> <td>[01]</td> </tr> </tbody> </table>	Kind	Value	pattern	[01]
Kind	Value				
pattern	[01]				
source	<pre><xs:element name="RicezioneAvvisoTelem" type="cm:DatoCB_Type" minOccurs="0"/></pre>				

element **Impegno_A_Trasmettere_Type/DatalImpegno**

diagram	
namespace	urn:www.agenziaentrate.gov.it:specificheTecniche:sco:common
type	DatoDT_Type

facets	Kind pattern	Value (((0[1-9][12][0-9][301])(0[13578][1012](\d{4})) ((0[1-9][12][0-9][30](0[469][11](\d{4})) ((0[1-9][10-9][20-8])(02)(\d{4})) ((29)(02)([02468][048]00)) ((29)(02)([13579][26]00)) ((29)(02)([0-9][0148])) ((29)(02)([0-9][0-9][2468][048])) ((29)(02)([0-9][0-9][13579][26]))))
source	<xs:element name="DataImpegno" type="cm:DatoDT_Type"/>	

element **Impegno_A Trasmettere_Type/FirmaIntermediario**

diagram		
namespace	urn:www.agenziaentrate.gov.it:specificheTecniche:sco:common	
type	DatoCB_Type	
facets	Kind pattern	Value [01]
source	<xs:element name="FirmaIntermediario" type="cm:DatoCB_Type"/>	

complexType **Persone_Fisiche_Type**

diagram		
namespace	urn:www.agenziaentrate.gov.it:specificheTecniche:sco:common	
children	DatiAnagrafici ResidenzaAnagrafica	
source	<pre><xs:complexType name="Persone_Fisiche_Type"> <xs:sequence> <xs:element name="DatiAnagrafici" type="Dati_Anagrafici_Type"/> <xs:element name="ResidenzaAnagrafica" type="Residenza_Anagrafica_Type"/> </xs:sequence> </xs:complexType></pre>	

element **Persone_Fisiche_Type/DatiAnagrafici**

diagram	
namespace	urn:www.agenziaentrate.gov.it:specificheTecniche:sco:common
type	Dati_Anagrafici_Type
children	Cognome Nome Sesso DataNascita ComuneNascita ProvinciaNascita

source	<xs:element name="DatiAnagrafici" type="Dati_Anagrafici_Type"/>
--------	---

element **Persone_Fisiche_Type/ResidenzaAnagrafica**

diagram	
namespace	urn:www.agenziaentrate.gov.it:specificheTecniche:sco:common
type	Residenza_Anagrafica_Type
children	Comune Provincia CodiceComune Indirizzo Cap DataVariazione
source	<xs:element name="ResidenzaAnagrafica" type="Residenza_Anagrafica_Type"/>

complexType **Residenza_Anagrafica_Type**

diagram	
namespace	urn:www.agenziaentrate.gov.it:specificheTecniche:sco:common
type	extension of Domicilio_Ita_Type
children	Comune Provincia CodiceComune Indirizzo Cap DataVariazione
source	<pre> <xs:complexType name="Residenza_Anagrafica_Type"> <xs:complexContent> <xs:extension base="Domicilio_Ita_Type"> <xs:sequence> <xs:element name="DataVariazione" type="cm:DatoDT_Type" minOccurs="0"/> </xs:sequence> </xs:extension> </xs:complexContent> </xs:complexType> </pre>

	<pre> </xs:extension> </xs:complexContent> </xs:complexType> </pre>
--	---

element **Residenza_Anagrafica_Type/DataVariazione**

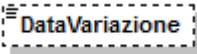
diagram					
namespace	urn:www.agenziaentrate.gov.it:specificheTecniche:sco:common				
type	DatoDT_Type				
facets	<table border="1"> <thead> <tr> <th>Kind</th> <th>Value</th> </tr> </thead> <tbody> <tr> <td>pattern</td> <td>(((0[1-9][12][0-9]3[01])(0[13578]10[12](\d{4})) ((0[1-9][12][0-9]30)(0[469]11)(\d{4})) ((0[1-9]1[0-9]2[0-8])(02)(\d{4})) ((29)(02)([02468][048]00)) ((29)(02)([13579][26]00)) ((29)(02)([0-9][0-9][0][48])) ((29)(02)([0-9][0-9][2468][048])) ((29)(02)([0-9][0-9][13579][26]))))</td> </tr> </tbody> </table>	Kind	Value	pattern	(((0[1-9][12][0-9]3[01])(0[13578]10[12](\d{4})) ((0[1-9][12][0-9]30)(0[469]11)(\d{4})) ((0[1-9]1[0-9]2[0-8])(02)(\d{4})) ((29)(02)([02468][048]00)) ((29)(02)([13579][26]00)) ((29)(02)([0-9][0-9][0][48])) ((29)(02)([0-9][0-9][2468][048])) ((29)(02)([0-9][0-9][13579][26]))))
Kind	Value				
pattern	(((0[1-9][12][0-9]3[01])(0[13578]10[12](\d{4})) ((0[1-9][12][0-9]30)(0[469]11)(\d{4})) ((0[1-9]1[0-9]2[0-8])(02)(\d{4})) ((29)(02)([02468][048]00)) ((29)(02)([13579][26]00)) ((29)(02)([0-9][0-9][0][48])) ((29)(02)([0-9][0-9][2468][048])) ((29)(02)([0-9][0-9][13579][26]))))				
source	<code><xs:element name="DataVariazione" type="cm:DatoDT_Type" minOccurs="0"/></code>				

complexType **Residenza_Estera_Type**

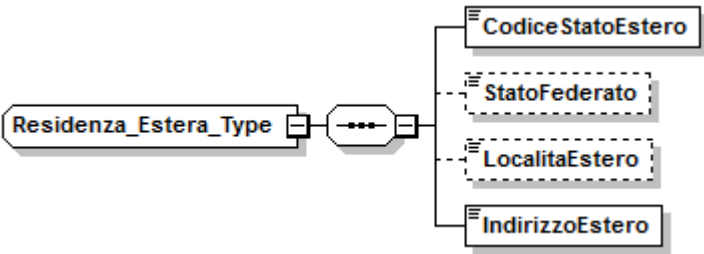
diagram	
namespace	urn:www.agenziaentrate.gov.it:specificheTecniche:sco:common
children	CodiceStatoEstero StatoFederato LocalitaEstero IndirizzoEstero
source	<pre> <xs:complexType name="Residenza_Estera_Type"> <xs:sequence> <xs:element name="CodiceStatoEstero"> <xs:simpleType> <xs:restriction base="cm:DatoAN_Type"> <xs:maxLength value="3"/> <xs:minLength value="3"/> </xs:restriction> </xs:simpleType> </xs:element> <xs:element name="StatoFederato" minOccurs="0"> <xs:simpleType> <xs:restriction base="cm:DatoAN_Type"> <xs:maxLength value="24"/> </xs:restriction> </xs:simpleType> </xs:element> <xs:element name="LocalitaEstero" type="cm:DatoAN_Type" minOccurs="0"/> <xs:element name="IndirizzoEstero" type="cm:DatoAN_Type"/> </xs:sequence> </xs:complexType> </pre>

element **Residenza_Estera_Type/CodiceStatoEstero**

diagram	
namespace	urn:www.agenziaentrate.gov.it:specificheTecniche:sco:common

type	restriction of DatoAN_Type
facets	Kind Value pattern <code>(([0-9A-Z-])&quot;){1}([0-9A-Z&amp;:] ' \"- _ . / ^ \\(\\) À É È Ì Ò Ù Û &quot; \\ \\ \\ +)*</code>
source	<pre><xs:element name="CodiceStatoEstero"> <xs:simpleType> <xs:restriction base="cm:DatoAN_Type"> <xs:maxLength value="3"/> <xs:minLength value="3"/> </xs:restriction> </xs:simpleType> </xs:element></pre>

element **Residenza_Estera_Type/StatoFederato**

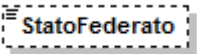
diagram	
namespace	urn:www.agenziaentrate.gov.it:specificheTecniche:sco:common
type	restriction of DatoAN_Type
facets	Kind Value pattern <code>(([0-9A-Z-])&quot;){1}([0-9A-Z&amp;:] ' \"- _ . / ^ \\(\\) À É È Ì Ò Ù Û &quot; \\ \\ \\ +)*</code>
source	<pre><xs:element name="StatoFederato" minOccurs="0"> <xs:simpleType> <xs:restriction base="cm:DatoAN_Type"> <xs:maxLength value="24"/> </xs:restriction> </xs:simpleType> </xs:element></pre>

element **Residenza_Estera_Type/LocalitaEstero**

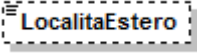
diagram	
namespace	urn:www.agenziaentrate.gov.it:specificheTecniche:sco:common
type	DatoAN_Type
facets	Kind Value pattern <code>(([0-9A-Z-])&quot;){1}([0-9A-Z&amp;:] ' \"- _ . / ^ \\(\\) À É È Ì Ò Ù Û &quot; \\ \\ \\ +)*</code>
source	<pre><xs:element name="LocalitaEstero" type="cm:DatoAN_Type" minOccurs="0"/></pre>

element **Residenza_Estera_Type/IndirizzoEstero**

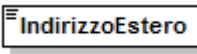
diagram	
namespace	urn:www.agenziaentrate.gov.it:specificheTecniche:sco:common
type	DatoAN_Type
facets	Kind Value pattern <code>(([0-9A-Z-])&quot;){1}([0-9A-Z&amp;:] ' \"- _ . / ^ \\(\\) À É È Ì Ò Ù Û &quot; \\ \\ \\ +)*</code>
source	<pre><xs:element name="IndirizzoEstero" type="cm:DatoAN_Type"/></pre>

element **Soggetti_Diversi_Da_PF_Type/SedeLegale**

diagram	
namespace	urn:www.agenziaentrate.gov.it:specificheTecniche:sco:common
type	Domicilio_EE_Type
children	Comune Provincia CodiceComune Indirizzo Cap DataVariazione
source	<xs:element name="SedeLegale" type="Domicilio_EE_Type"/>

element **Soggetti_Diversi_Da_PF_Type/DomicilioFiscale**

diagram	
namespace	urn:www.agenziaentrate.gov.it:specificheTecniche:sco:common
type	Domicilio_Fiscale_Type
children	Comune Provincia CodiceComune Indirizzo Cap DataVariazione
source	<xs:element name="DomicilioFiscale" type="Domicilio_Fiscale_Type" minOccurs="0"/>

element **Soggetti_Diversi_Da_PF_Type/DataApprovazioneBilancio**

diagram	
namespace	urn:www.agenziaentrate.gov.it:specificheTecniche:sco:common

type	DatoDT_Type				
facets	<table border="1"> <tr> <td>Kind</td> <td>Value</td> </tr> <tr> <td>pattern</td> <td>(((0[1-9][12][0-9]3[01])(0[13578]10 12)\d{4}))(((0[1-9][12][0-9]30)(0[469]11)\d{4}))(((0[1-9]1[0-9]2[0-8])(02)\d{4}))(((29)(02)([02468][048]00))(((29)(02)([13579][26]00))(((29)(02)([0-9][0-9][0][48]))(((29)(02)([0-9][0-9][2468][048]))(((29)(02)([0-9][0-9][13579][26]))))</td> </tr> </table>	Kind	Value	pattern	(((0[1-9][12][0-9]3[01])(0[13578]10 12)\d{4}))(((0[1-9][12][0-9]30)(0[469]11)\d{4}))(((0[1-9]1[0-9]2[0-8])(02)\d{4}))(((29)(02)([02468][048]00))(((29)(02)([13579][26]00))(((29)(02)([0-9][0-9][0][48]))(((29)(02)([0-9][0-9][2468][048]))(((29)(02)([0-9][0-9][13579][26]))))
Kind	Value				
pattern	(((0[1-9][12][0-9]3[01])(0[13578]10 12)\d{4}))(((0[1-9][12][0-9]30)(0[469]11)\d{4}))(((0[1-9]1[0-9]2[0-8])(02)\d{4}))(((29)(02)([02468][048]00))(((29)(02)([13579][26]00))(((29)(02)([0-9][0-9][0][48]))(((29)(02)([0-9][0-9][2468][048]))(((29)(02)([0-9][0-9][13579][26]))))				
source	<xs:element name="DataApprovazioneBilancio" type="cm:DatoDT_Type" minOccurs="0"/>				

element **Soggetti_Diversi_Da_PF_Type/TermineApprovazioneBilancio**

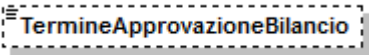
diagram					
namespace	urn:www.agenziaentrate.gov.it:specificheTecniche:sco:common				
type	DatoDT_Type				
facets	<table border="1"> <tr> <td>Kind</td> <td>Value</td> </tr> <tr> <td>pattern</td> <td>(((0[1-9][12][0-9]3[01])(0[13578]10 12)\d{4}))(((0[1-9][12][0-9]30)(0[469]11)\d{4}))(((0[1-9]1[0-9]2[0-8])(02)\d{4}))(((29)(02)([02468][048]00))(((29)(02)([13579][26]00))(((29)(02)([0-9][0-9][0][48]))(((29)(02)([0-9][0-9][2468][048]))(((29)(02)([0-9][0-9][13579][26]))))</td> </tr> </table>	Kind	Value	pattern	(((0[1-9][12][0-9]3[01])(0[13578]10 12)\d{4}))(((0[1-9][12][0-9]30)(0[469]11)\d{4}))(((0[1-9]1[0-9]2[0-8])(02)\d{4}))(((29)(02)([02468][048]00))(((29)(02)([13579][26]00))(((29)(02)([0-9][0-9][0][48]))(((29)(02)([0-9][0-9][2468][048]))(((29)(02)([0-9][0-9][13579][26]))))
Kind	Value				
pattern	(((0[1-9][12][0-9]3[01])(0[13578]10 12)\d{4}))(((0[1-9][12][0-9]30)(0[469]11)\d{4}))(((0[1-9]1[0-9]2[0-8])(02)\d{4}))(((29)(02)([02468][048]00))(((29)(02)([13579][26]00))(((29)(02)([0-9][0-9][0][48]))(((29)(02)([0-9][0-9][2468][048]))(((29)(02)([0-9][0-9][13579][26]))))				
source	<xs:element name="TermineApprovazioneBilancio" type="cm:DatoDT_Type" minOccurs="0"/>				

element **Soggetti_Diversi_Da_PF_Type/InizioPeriodoImposta**

diagram					
namespace	urn:www.agenziaentrate.gov.it:specificheTecniche:sco:common				
type	DatoDT_Type				
facets	<table border="1"> <tr> <td>Kind</td> <td>Value</td> </tr> <tr> <td>pattern</td> <td>(((0[1-9][12][0-9]3[01])(0[13578]10 12)\d{4}))(((0[1-9][12][0-9]30)(0[469]11)\d{4}))(((0[1-9]1[0-9]2[0-8])(02)\d{4}))(((29)(02)([02468][048]00))(((29)(02)([13579][26]00))(((29)(02)([0-9][0-9][0][48]))(((29)(02)([0-9][0-9][2468][048]))(((29)(02)([0-9][0-9][13579][26]))))</td> </tr> </table>	Kind	Value	pattern	(((0[1-9][12][0-9]3[01])(0[13578]10 12)\d{4}))(((0[1-9][12][0-9]30)(0[469]11)\d{4}))(((0[1-9]1[0-9]2[0-8])(02)\d{4}))(((29)(02)([02468][048]00))(((29)(02)([13579][26]00))(((29)(02)([0-9][0-9][0][48]))(((29)(02)([0-9][0-9][2468][048]))(((29)(02)([0-9][0-9][13579][26]))))
Kind	Value				
pattern	(((0[1-9][12][0-9]3[01])(0[13578]10 12)\d{4}))(((0[1-9][12][0-9]30)(0[469]11)\d{4}))(((0[1-9]1[0-9]2[0-8])(02)\d{4}))(((29)(02)([02468][048]00))(((29)(02)([13579][26]00))(((29)(02)([0-9][0-9][0][48]))(((29)(02)([0-9][0-9][2468][048]))(((29)(02)([0-9][0-9][13579][26]))))				
source	<xs:element name="InizioPeriodoImposta" type="cm:DatoDT_Type"/>				

element **Soggetti_Diversi_Da_PF_Type/FinePeriodoImposta**

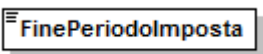
diagram					
namespace	urn:www.agenziaentrate.gov.it:specificheTecniche:sco:common				
type	DatoDT_Type				
facets	<table border="1"> <tr> <td>Kind</td> <td>Value</td> </tr> <tr> <td>pattern</td> <td>(((0[1-9][12][0-9]3[01])(0[13578]10 12)\d{4}))(((0[1-9][12][0-9]30)(0[469]11)\d{4}))(((0[1-9]1[0-9]2[0-8])(02)\d{4}))(((29)(02)([02468][048]00))(((29)(02)([13579][26]00))(((29)(02)([0-9][0-9][0][48]))(((29)(02)([0-9][0-9][2468][048]))(((29)(02)([0-9][0-9][13579][26]))))</td> </tr> </table>	Kind	Value	pattern	(((0[1-9][12][0-9]3[01])(0[13578]10 12)\d{4}))(((0[1-9][12][0-9]30)(0[469]11)\d{4}))(((0[1-9]1[0-9]2[0-8])(02)\d{4}))(((29)(02)([02468][048]00))(((29)(02)([13579][26]00))(((29)(02)([0-9][0-9][0][48]))(((29)(02)([0-9][0-9][2468][048]))(((29)(02)([0-9][0-9][13579][26]))))
Kind	Value				
pattern	(((0[1-9][12][0-9]3[01])(0[13578]10 12)\d{4}))(((0[1-9][12][0-9]30)(0[469]11)\d{4}))(((0[1-9]1[0-9]2[0-8])(02)\d{4}))(((29)(02)([02468][048]00))(((29)(02)([13579][26]00))(((29)(02)([0-9][0-9][0][48]))(((29)(02)([0-9][0-9][2468][048]))(((29)(02)([0-9][0-9][13579][26]))))				
source	<xs:element name="FinePeriodoImposta" type="cm:DatoDT_Type"/>				

element **Soggetti_Diversi_Da_PF_Type/Stato**

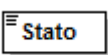
diagram					
namespace	urn:www.agenziaentrate.gov.it:specificheTecniche:sco:common				
type	Stato_Type				
facets	<table border="1"> <tr> <td>Kind</td> <td>Value</td> </tr> <tr> <td>pattern</td> <td>[1-9]{1}[0-9]*</td> </tr> </table>	Kind	Value	pattern	[1-9]{1}[0-9]*
Kind	Value				
pattern	[1-9]{1}[0-9]*				

	enumeration 1 enumeration 2 enumeration 3 enumeration 4
source	<xs:element name="Stato" type="Stato_Type"/>

element **Soggetti_Diversi_Da_PF_Type/NaturaGiuridica**

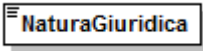
diagram																																																																																																											
namespace	urn:www.agenziaentrate.gov.it:specificheTecniche:sco:common																																																																																																										
type	Natura Giuridica Type																																																																																																										
facets	<table border="1"> <thead> <tr> <th>Kind</th> <th>Value</th> </tr> </thead> <tbody> <tr> <td>pattern</td> <td>[1-9]{1}[0-9]*</td> </tr> <tr><td>enumeration</td><td>1</td></tr> <tr><td>enumeration</td><td>2</td></tr> <tr><td>enumeration</td><td>3</td></tr> <tr><td>enumeration</td><td>4</td></tr> <tr><td>enumeration</td><td>5</td></tr> <tr><td>enumeration</td><td>6</td></tr> <tr><td>enumeration</td><td>7</td></tr> <tr><td>enumeration</td><td>8</td></tr> <tr><td>enumeration</td><td>9</td></tr> <tr><td>enumeration</td><td>10</td></tr> <tr><td>enumeration</td><td>11</td></tr> <tr><td>enumeration</td><td>12</td></tr> <tr><td>enumeration</td><td>13</td></tr> <tr><td>enumeration</td><td>14</td></tr> <tr><td>enumeration</td><td>15</td></tr> <tr><td>enumeration</td><td>16</td></tr> <tr><td>enumeration</td><td>17</td></tr> <tr><td>enumeration</td><td>18</td></tr> <tr><td>enumeration</td><td>19</td></tr> <tr><td>enumeration</td><td>20</td></tr> <tr><td>enumeration</td><td>21</td></tr> <tr><td>enumeration</td><td>22</td></tr> <tr><td>enumeration</td><td>23</td></tr> <tr><td>enumeration</td><td>24</td></tr> <tr><td>enumeration</td><td>25</td></tr> <tr><td>enumeration</td><td>26</td></tr> <tr><td>enumeration</td><td>27</td></tr> <tr><td>enumeration</td><td>28</td></tr> <tr><td>enumeration</td><td>29</td></tr> <tr><td>enumeration</td><td>30</td></tr> <tr><td>enumeration</td><td>31</td></tr> <tr><td>enumeration</td><td>32</td></tr> <tr><td>enumeration</td><td>33</td></tr> <tr><td>enumeration</td><td>34</td></tr> <tr><td>enumeration</td><td>35</td></tr> <tr><td>enumeration</td><td>36</td></tr> <tr><td>enumeration</td><td>37</td></tr> <tr><td>enumeration</td><td>38</td></tr> <tr><td>enumeration</td><td>39</td></tr> <tr><td>enumeration</td><td>40</td></tr> <tr><td>enumeration</td><td>41</td></tr> <tr><td>enumeration</td><td>42</td></tr> <tr><td>enumeration</td><td>43</td></tr> <tr><td>enumeration</td><td>44</td></tr> <tr><td>enumeration</td><td>45</td></tr> <tr><td>enumeration</td><td>50</td></tr> <tr><td>enumeration</td><td>51</td></tr> <tr><td>enumeration</td><td>52</td></tr> <tr><td>enumeration</td><td>53</td></tr> <tr><td>enumeration</td><td>54</td></tr> <tr><td>enumeration</td><td>55</td></tr> </tbody> </table>	Kind	Value	pattern	[1-9]{1}[0-9]*	enumeration	1	enumeration	2	enumeration	3	enumeration	4	enumeration	5	enumeration	6	enumeration	7	enumeration	8	enumeration	9	enumeration	10	enumeration	11	enumeration	12	enumeration	13	enumeration	14	enumeration	15	enumeration	16	enumeration	17	enumeration	18	enumeration	19	enumeration	20	enumeration	21	enumeration	22	enumeration	23	enumeration	24	enumeration	25	enumeration	26	enumeration	27	enumeration	28	enumeration	29	enumeration	30	enumeration	31	enumeration	32	enumeration	33	enumeration	34	enumeration	35	enumeration	36	enumeration	37	enumeration	38	enumeration	39	enumeration	40	enumeration	41	enumeration	42	enumeration	43	enumeration	44	enumeration	45	enumeration	50	enumeration	51	enumeration	52	enumeration	53	enumeration	54	enumeration	55
Kind	Value																																																																																																										
pattern	[1-9]{1}[0-9]*																																																																																																										
enumeration	1																																																																																																										
enumeration	2																																																																																																										
enumeration	3																																																																																																										
enumeration	4																																																																																																										
enumeration	5																																																																																																										
enumeration	6																																																																																																										
enumeration	7																																																																																																										
enumeration	8																																																																																																										
enumeration	9																																																																																																										
enumeration	10																																																																																																										
enumeration	11																																																																																																										
enumeration	12																																																																																																										
enumeration	13																																																																																																										
enumeration	14																																																																																																										
enumeration	15																																																																																																										
enumeration	16																																																																																																										
enumeration	17																																																																																																										
enumeration	18																																																																																																										
enumeration	19																																																																																																										
enumeration	20																																																																																																										
enumeration	21																																																																																																										
enumeration	22																																																																																																										
enumeration	23																																																																																																										
enumeration	24																																																																																																										
enumeration	25																																																																																																										
enumeration	26																																																																																																										
enumeration	27																																																																																																										
enumeration	28																																																																																																										
enumeration	29																																																																																																										
enumeration	30																																																																																																										
enumeration	31																																																																																																										
enumeration	32																																																																																																										
enumeration	33																																																																																																										
enumeration	34																																																																																																										
enumeration	35																																																																																																										
enumeration	36																																																																																																										
enumeration	37																																																																																																										
enumeration	38																																																																																																										
enumeration	39																																																																																																										
enumeration	40																																																																																																										
enumeration	41																																																																																																										
enumeration	42																																																																																																										
enumeration	43																																																																																																										
enumeration	44																																																																																																										
enumeration	45																																																																																																										
enumeration	50																																																																																																										
enumeration	51																																																																																																										
enumeration	52																																																																																																										
enumeration	53																																																																																																										
enumeration	54																																																																																																										
enumeration	55																																																																																																										

	enumeration 56 enumeration 57 enumeration 58 enumeration 59
source	<code><xs:element name="NaturaGiuridica" type="Natura_Giuridica_Type"/></code>

element **Soggetti_Diversi_Da_PF_Type/Situazione**

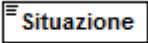
diagram																			
namespace	urn:www.agenziaentrate.gov.it:specificheTecniche:sco:common																		
type	Situazione_Type																		
facets	<table border="1"> <thead> <tr> <th>Kind</th> <th>Value</th> </tr> </thead> <tbody> <tr> <td>pattern</td> <td>[1-9]{1}[0-9]*</td> </tr> <tr> <td>enumeration</td> <td>1</td> </tr> <tr> <td>enumeration</td> <td>2</td> </tr> <tr> <td>enumeration</td> <td>3</td> </tr> <tr> <td>enumeration</td> <td>4</td> </tr> <tr> <td>enumeration</td> <td>5</td> </tr> <tr> <td>enumeration</td> <td>6</td> </tr> <tr> <td>enumeration</td> <td>7</td> </tr> </tbody> </table>	Kind	Value	pattern	[1-9]{1}[0-9]*	enumeration	1	enumeration	2	enumeration	3	enumeration	4	enumeration	5	enumeration	6	enumeration	7
Kind	Value																		
pattern	[1-9]{1}[0-9]*																		
enumeration	1																		
enumeration	2																		
enumeration	3																		
enumeration	4																		
enumeration	5																		
enumeration	6																		
enumeration	7																		
source	<code><xs:element name="Situazione" type="Situazione_Type"/></code>																		

complexType **Soggetti_Non_Residenti_Type**

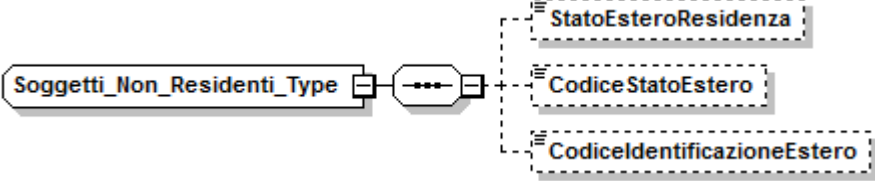
diagram	
namespace	urn:www.agenziaentrate.gov.it:specificheTecniche:sco:common
children	StatoEsteroResidenza CodiceStatoEstero CodiceIdentificazioneEstero
source	<pre> <xs:complexType name="Soggetti_Non_Residenti_Type"> <xs:sequence> <xs:element name="StatoEsteroResidenza" type="cm:DatoAN_Type" minOccurs="0"/> <xs:element name="CodiceStatoEstero" type="cm:DatoAN_Type" minOccurs="0"/> <xs:element name="CodiceIdentificazioneEstero" type="cm:DatoAN_Type" minOccurs="0"/> </xs:sequence> </xs:complexType> </pre>

element **Soggetti_Non_Residenti_Type/StatoEsteroResidenza**

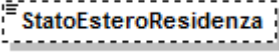
diagram					
namespace	urn:www.agenziaentrate.gov.it:specificheTecniche:sco:common				
type	DatoAN_Type				
facets	<table border="1"> <thead> <tr> <th>Kind</th> <th>Value</th> </tr> </thead> <tbody> <tr> <td>pattern</td> <td>([0-9A-Z-] \&quot;){1}([0-9A-Z&amp;] '\- \., /' \^\(\ \)\^ È É Ì Ò Ù Ú &quot;; \\ / +)*</td> </tr> </tbody> </table>	Kind	Value	pattern	([0-9A-Z-] \"){1}([0-9A-Z&] '\- \., /' \^\(\ \)\^ È É Ì Ò Ù Ú "; \\ / +)*
Kind	Value				
pattern	([0-9A-Z-] \"){1}([0-9A-Z&] '\- \., /' \^\(\ \)\^ È É Ì Ò Ù Ú "; \\ / +)*				
source	<code><xs:element name="StatoEsteroResidenza" type="cm:DatoAN_Type" minOccurs="0"/></code>				

element **Soggetti_Non_Residenti_Type/CodiceStatoEstero**

diagram	
namespace	urn:www.agenziaentrate.gov.it:specificheTecniche:sco:common
type	DatoAN_Type
facets	Kind Value pattern ([0-9A-Z-]*)"){1}([0-9A-Z&:] [-\., /°\^\(\)\ À È É Ì Ò Ù Û " \ \\ / +)*
source	<code><xs:element name="CodiceStatoEstero" type="cm:DatoAN_Type" minOccurs="0"/></code>

element **Soggetti_Non_Residenti_Type/CodicelIdentificazioneEstero**

diagram	
namespace	urn:www.agenziaentrate.gov.it:specificheTecniche:sco:common
type	DatoAN_Type
facets	Kind Value pattern ([0-9A-Z-]*)"){1}([0-9A-Z&:] [-\., /°\^\(\)\ À È É Ì Ò Ù Û " \ \\ / +)*
source	<code><xs:element name="CodicelIdentificazioneEstero" type="cm:DatoAN_Type" minOccurs="0"/></code>

complexType **Soggetto_Fiscale_Type**

diagram	
namespace	urn:www.agenziaentrate.gov.it:specificheTecniche:sco:common
children	CodiceFiscale Email Telefono Fax
source	<code><xs:complexType name="Soggetto_Fiscale_Type"> <xs:sequence> <xs:element name="CodiceFiscale" type="cm:DatoCF_Type"/> <xs:element name="Email" type="cm:DatoEM_Type" minOccurs="0"/> <xs:element name="Telefono" type="cm:DatoTL_Type" minOccurs="0"/> <xs:element name="Fax" type="cm:DatoTL_Type" minOccurs="0"/> </xs:sequence> </xs:complexType></code>

element **Soggetto_Fiscale_Type/CodiceFiscale**

diagram	
namespace	urn:www.agenziaentrate.gov.it:specificheTecniche:sco:common
type	DatoCF_Type
facets	Kind Value pattern [0-9]{11}[A-Z]{6}[0-9LMNPQRSTU]{2}[A-Z]{1}[0-9LMNPQRSTU]{2}[A-Z]{1}[0-9LMNPQRSTU]{3}[A-Z]{1}
source	<code><xs:element name="CodiceFiscale" type="cm:DatoCF_Type"/></code>

element **Soggetto_Fiscale_Type/Email**

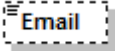
diagram					
namespace	urn:www.agenziaentrate.gov.it:specificheTecniche:sco:common				
type	DatoEM_Type				
facets	<table border="1"> <thead> <tr> <th>Kind</th> <th>Value</th> </tr> </thead> <tbody> <tr> <td>pattern</td> <td>[a-zA-Z0-9._%'\-'\&quot;?^~=]+@[a-zA-Z0-9.\-]+\.[a-zA-Z]{2,4}</td> </tr> </tbody> </table>	Kind	Value	pattern	[a-zA-Z0-9._%'\-'\"?^~=]+@[a-zA-Z0-9.\-]+\.[a-zA-Z]{2,4}
Kind	Value				
pattern	[a-zA-Z0-9._%'\-'\"?^~=]+@[a-zA-Z0-9.\-]+\.[a-zA-Z]{2,4}				
source	<code><xs:element name="Email" type="cm:DatoEM_Type" minOccurs="0"/></code>				

element **Soggetto_Fiscale_Type/Telefono**

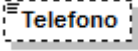
diagram					
namespace	urn:www.agenziaentrate.gov.it:specificheTecniche:sco:common				
type	DatoTL_Type				
facets	<table border="1"> <thead> <tr> <th>Kind</th> <th>Value</th> </tr> </thead> <tbody> <tr> <td>pattern</td> <td>[0-9]*</td> </tr> </tbody> </table>	Kind	Value	pattern	[0-9]*
Kind	Value				
pattern	[0-9]*				
source	<code><xs:element name="Telefono" type="cm:DatoTL_Type" minOccurs="0"/></code>				

element **Soggetto_Fiscale_Type/Fax**

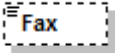
diagram					
namespace	urn:www.agenziaentrate.gov.it:specificheTecniche:sco:common				
type	DatoTL_Type				
facets	<table border="1"> <thead> <tr> <th>Kind</th> <th>Value</th> </tr> </thead> <tbody> <tr> <td>pattern</td> <td>[0-9]*</td> </tr> </tbody> </table>	Kind	Value	pattern	[0-9]*
Kind	Value				
pattern	[0-9]*				
source	<code><xs:element name="Fax" type="cm:DatoTL_Type" minOccurs="0"/></code>				

complexType **Tipo_Dichiarazione_Type**

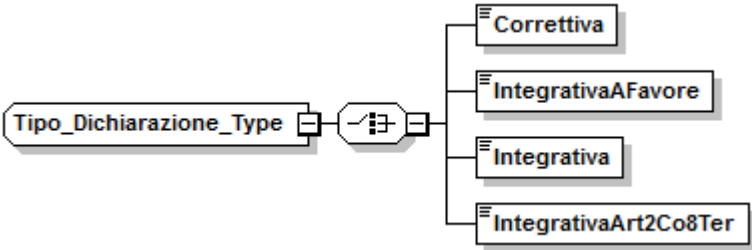
diagram	
namespace	urn:www.agenziaentrate.gov.it:specificheTecniche:sco:common
children	Correttiva IntegrativaAFavore Integrativa IntegrativaArt2Co8Ter
source	<code><xs:complexType name="Tipo_Dichiarazione_Type"> <xs:choice> <xs:element name="Correttiva" type="cm:DatoCB_Type"/> <xs:element name="IntegrativaAFavore" type="cm:DatoCB_Type"/> <xs:element name="Integrativa" type="cm:DatoCB_Type"/> <xs:element name="IntegrativaArt2Co8Ter" type="cm:DatoCB_Type"/> </xs:choice> </xs:complexType></code>

element Tipo Dichiarazione_Type/Correttiva

diagram	
namespace	urn:www.agenziaentrate.gov.it:specificheTecniche:sco:common
type	DatoCB_Type
facets	Kind Value pattern [01]
source	<xs:element name="Correttiva" type="cm:DatoCB_Type"/>

element Tipo Dichiarazione_Type/IntegrativaAFavore

diagram	
namespace	urn:www.agenziaentrate.gov.it:specificheTecniche:sco:common
type	DatoCB_Type
facets	Kind Value pattern [01]
source	<xs:element name="IntegrativaAFavore" type="cm:DatoCB_Type"/>

element Tipo Dichiarazione_Type/Integrativa

diagram	
namespace	urn:www.agenziaentrate.gov.it:specificheTecniche:sco:common
type	DatoCB_Type
facets	Kind Value pattern [01]
source	<xs:element name="Integrativa" type="cm:DatoCB_Type"/>

element Tipo Dichiarazione_Type/IntegrativaArt2Co8Ter

diagram	
namespace	urn:www.agenziaentrate.gov.it:specificheTecniche:sco:common
type	DatoCB_Type
facets	Kind Value pattern [01]
source	<xs:element name="IntegrativaArt2Co8Ter" type="cm:DatoCB_Type"/>

complexType Visto_Conformita_Type

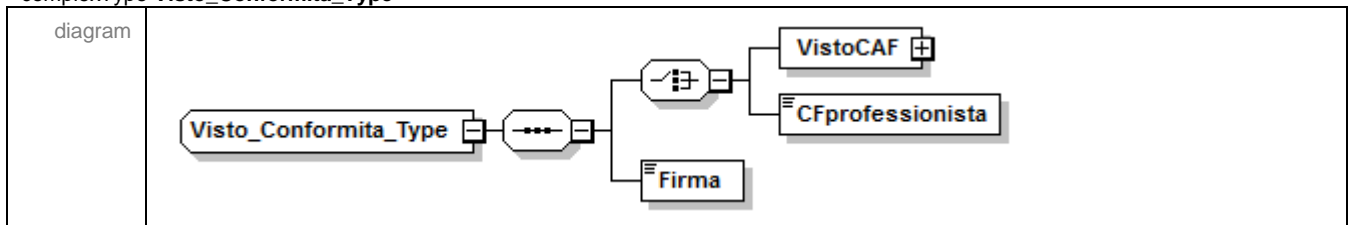

namespace	urn:www.agenziaentrate.gov.it:specificheTecniche:sco:common
children	VistoCAF CFprofessionista Firma
source	<pre> <xs:complexType name="Visto_Conformita_Type"> <xs:sequence> <xs:choice> <xs:element name="VistoCAF"> <xs:complexType> <xs:sequence> <xs:element name="CFResp" type="cm:DatoCF_Type"/> <xs:element name="CF_CAF" type="cm:DatoCN_Type"/> </xs:sequence> </xs:complexType> </xs:element> <xs:element name="CFprofessionista" type="cm:DatoCF_Type"/> </xs:choice> <xs:element name="Firma" type="cm:DatoCB_Type"/> </xs:sequence> </xs:complexType> </pre>

element **Visto_Conformita_Type/VistoCAF**

diagram	<pre> graph LR VistoCAF -- contains --> Choice subgraph Choice CFResp CF_CAF end </pre>
namespace	urn:www.agenziaentrate.gov.it:specificheTecniche:sco:common
children	CFResp CF_CAF
source	<pre> <xs:element name="VistoCAF"> <xs:complexType> <xs:sequence> <xs:element name="CFResp" type="cm:DatoCF_Type"/> <xs:element name="CF_CAF" type="cm:DatoCN_Type"/> </xs:sequence> </xs:complexType> </xs:element> </pre>

element **Visto_Conformita_Type/VistoCAF/CFResp**

diagram	<pre> graph LR CFResp </pre>				
namespace	urn:www.agenziaentrate.gov.it:specificheTecniche:sco:common				
type	DatoCF_Type				
facets	<table border="1"> <thead> <tr> <th>Kind</th> <th>Value</th> </tr> </thead> <tbody> <tr> <td>pattern</td> <td>[0-9]{11}[A-Z]{6}[0-9LMNPQRSTUUV]{2}[A-Z]{1}[0-9LMNPQRSTUUV]{2}[A-Z]{1}[0-9LMNPQRSTUUV]{3}[A-Z]{1}</td> </tr> </tbody> </table>	Kind	Value	pattern	[0-9]{11}[A-Z]{6}[0-9LMNPQRSTUUV]{2}[A-Z]{1}[0-9LMNPQRSTUUV]{2}[A-Z]{1}[0-9LMNPQRSTUUV]{3}[A-Z]{1}
Kind	Value				
pattern	[0-9]{11}[A-Z]{6}[0-9LMNPQRSTUUV]{2}[A-Z]{1}[0-9LMNPQRSTUUV]{2}[A-Z]{1}[0-9LMNPQRSTUUV]{3}[A-Z]{1}				
source	<pre><xs:element name="CFResp" type="cm:DatoCF_Type"/></pre>				

element **Visto_Conformita_Type/VistoCAF/CF_CAF**

diagram	<pre> graph LR CF_CAF </pre>				
namespace	urn:www.agenziaentrate.gov.it:specificheTecniche:sco:common				
type	DatoCN_Type				
facets	<table border="1"> <thead> <tr> <th>Kind</th> <th>Value</th> </tr> </thead> <tbody> <tr> <td>pattern</td> <td>[0-9]{11}</td> </tr> </tbody> </table>	Kind	Value	pattern	[0-9]{11}
Kind	Value				
pattern	[0-9]{11}				

source	<xs:element name="CF_CAF" type="cm:DatoCN_Type"/>
--------	---

element **Visto_Conformita_Type/CFprofessionista**

diagram					
namespace	urn:www.agenziaentrate.gov.it:specificheTecniche:sco:common				
type	DatoCF_Type				
facets	<table border="1"> <thead> <tr> <th>Kind</th> <th>Value</th> </tr> </thead> <tbody> <tr> <td>pattern</td> <td>[0-9]{11}[A-Z]{6}[0-9LMNPQRSTUVWXYZ]{2}[A-Z]{1}[0-9LMNPQRSTUVWXYZ]{2}[A-Z]{1}[0-9LMNPQRSTUVWXYZ]{3}[A-Z]{1}</td> </tr> </tbody> </table>	Kind	Value	pattern	[0-9]{11}[A-Z]{6}[0-9LMNPQRSTUVWXYZ]{2}[A-Z]{1}[0-9LMNPQRSTUVWXYZ]{2}[A-Z]{1}[0-9LMNPQRSTUVWXYZ]{3}[A-Z]{1}
Kind	Value				
pattern	[0-9]{11}[A-Z]{6}[0-9LMNPQRSTUVWXYZ]{2}[A-Z]{1}[0-9LMNPQRSTUVWXYZ]{2}[A-Z]{1}[0-9LMNPQRSTUVWXYZ]{3}[A-Z]{1}				
source	<xs:element name="CFprofessionista" type="cm:DatoCF_Type"/>				

element **Visto_Conformita_Type/Firma**

diagram					
namespace	urn:www.agenziaentrate.gov.it:specificheTecniche:sco:common				
type	DatoCB_Type				
facets	<table border="1"> <thead> <tr> <th>Kind</th> <th>Value</th> </tr> </thead> <tbody> <tr> <td>pattern</td> <td>[01]</td> </tr> </tbody> </table>	Kind	Value	pattern	[01]
Kind	Value				
pattern	[01]				
source	<xs:element name="Firma" type="cm:DatoCB_Type"/>				

complexType **Dichiarazione_SCE_Type**

diagram	
namespace	urn:www.agenziaentrate.gov.it:specificheTecniche:sco:sce
children	sce:FlagAnomaliaCFAnag sce:Frontespizio
source	<pre><xs:complexType name="Dichiarazione_SCE_Type"> <xs:sequence> <xs:element name="FlagAnomaliaCFAnag" type="cm:DatoCB_Type" minOccurs="0"/> <xs:element name="Frontespizio" type="sce:Frontespizio_SCE_Type"/> </xs:sequence> </xs:complexType></pre>

element **Dichiarazione_SCE_Type/FlagAnomaliaCFAnag**

diagram					
namespace	urn:www.agenziaentrate.gov.it:specificheTecniche:sco:sce				
type	DatoCB_Type				
facets	<table border="1"> <thead> <tr> <th>Kind</th> <th>Value</th> </tr> </thead> <tbody> <tr> <td>pattern</td> <td>[01]</td> </tr> </tbody> </table>	Kind	Value	pattern	[01]
Kind	Value				
pattern	[01]				
source	<xs:element name="FlagAnomaliaCFAnag" type="cm:DatoCB_Type" minOccurs="0"/>				

element **Dichiarazione_SCE_Type/Frontespizio**

diagram	
namespace	urn:www.agenziaentrate.gov.it:specificheTecniche:sco:sce
type	sce:Frontespizio_SCE_Type
children	sce:CodiceFiscale sce:DatiAnagrafici sce:Scelte
source	<code><xs:element name="Frontespizio" type="sce:Frontespizio_SCE_Type"/></code>

complexType **Documento_SCE_Type**

diagram											
namespace	urn:www.agenziaentrate.gov.it:specificheTecniche:sco:sce										
type	extension of sce:Documento_Type										
children	sce:BustaVuota sce:CfBusta sce:DichiarazioneDichiarante sce:DichiarazioneConiuge sce:BanchePoste										
attributes	<table border="1"> <thead> <tr> <th>Name</th> <th>Type</th> <th>Use</th> <th>Default</th> <th>Fixed</th> </tr> </thead> <tbody> <tr> <td>identificativo</td> <td>Identificativo_Type</td> <td>required</td> <td></td> <td></td> </tr> </tbody> </table>	Name	Type	Use	Default	Fixed	identificativo	Identificativo_Type	required		
Name	Type	Use	Default	Fixed							
identificativo	Identificativo_Type	required									
source	<pre> <xs:complexType name="Documento_SCE_Type"> <xs:complexContent> <xs:extension base="sce:Documento_Type"> <xs:sequence> <xs:element name="DichiarazioneDichiarante" type="sce:Dichiarazione_SCE_Type"/> <xs:element name="DichiarazioneConiuge" type="sce:Dichiarazione_SCE_Type" minOccurs="0"/> <xs:element name="BanchePoste" minOccurs="0"> <xs:complexType> <xs:sequence> <xs:element name="NumProgPacco" minOccurs="0"> <xs:simpleType> <xs:restriction base="cm:DatoNP_Type"> <xs:maxLength value="7"/> </xs:restriction> </xs:element> </xs:sequence> </xs:complexType> </xs:element> </xs:sequence> </xs:extension> </xs:complexContent> </xs:complexType> </pre>										

	<pre> </xs:restriction> </xs:simpleType> </xs:element> <xs:element name="NumSeqDicIntPacco" minOccurs="0"> <xs:simpleType> <xs:restriction base="cm:DatoNP_Type"> <xs:maxLength value="3"/> </xs:restriction> </xs:simpleType> </xs:element> <xs:element name="CodCentroOperativo" minOccurs="0"> <xs:simpleType> <xs:restriction base="cm:DatoAN_Type"> <xs:maxLength value="1"/> </xs:restriction> </xs:simpleType> </xs:element> <xs:element name="FormatoErrato" type="cm:DatoCB_Type" minOccurs="0"/> <xs:element name="ProtIDmodErrato" type="cm:DatoCB_Type" minOccurs="0"/> <xs:element name="NumeroProtocollo"> <xs:simpleType> <xs:restriction base="cm:DatoAN_Type"> <xs:maxLength value="25"/> <xs:minLength value="18"/> </xs:restriction> </xs:simpleType> </xs:element> </xs:sequence> </xs:complexType> </xs:element> </xs:sequence> </xs:extension> </xs:complexContent> </xs:complexType> </pre>
--	--

element **Documento_SCE_Type/DichiarazioneDichiarante**

diagram	
namespace	urn:www.agenziaentrate.gov.it:specificheTecniche:sco:sce
type	sce:Dichiarazione_SCE_Type
children	sce:FlagAnomaliaCFAnag sce:Frontespizio
source	<xs:element name="DichiarazioneDichiarante" type="sce:Dichiarazione_SCE_Type"/>

element **Documento_SCE_Type/DichiarazioneConiuge**

diagram	
namespace	urn:www.agenziaentrate.gov.it:specificheTecniche:sco:sce

type	sce:Dichiarazione SCE Type
children	sce:FlagAnomaliaCFAnag sce:Frontespizio
source	<code><xs:element name="DichiarazioneConiuge" type="sce:Dichiarazione_SCE_Type" minOccurs="0"/></code>

element **Documento_SCE_Type/BanchePoste**

diagram	<pre> graph LR BanchePoste[sce:BanchePoste] --- Seq(()) Seq --- NumProgPacco[sce:NumProgPacco] Seq --- NumSeqDicIntPacco[sce:NumSeqDicIntPacco] Seq --- CodCentroOperativo[sce:CodCentroOperativo] Seq --- FormatoErrato[sce:FormatoErrato] Seq --- ProtIDmodErrato[sce:ProtIDmodErrato] Seq --- NumeroProtocollo[sce:NumeroProtocollo] </pre>
namespace	urn:www.agenziaentrate.gov.it:specificheTecniche:sco:sce
children	sce:NumProgPacco sce:NumSeqDicIntPacco sce:CodCentroOperativo sce:FormatoErrato sce:ProtIDmodErrato sce:NumeroProtocollo
source	<pre> <xs:element name="BanchePoste" minOccurs="0"> <xs:complexType> <xs:sequence> <xs:element name="NumProgPacco" minOccurs="0"> <xs:simpleType> <xs:restriction base="cm:DatoNP_Type"> <xs:maxLength value="7"/> </xs:restriction> </xs:simpleType> </xs:element> <xs:element name="NumSeqDicIntPacco" minOccurs="0"> <xs:simpleType> <xs:restriction base="cm:DatoNP_Type"> <xs:maxLength value="3"/> </xs:restriction> </xs:simpleType> </xs:element> <xs:element name="CodCentroOperativo" minOccurs="0"> <xs:simpleType> <xs:restriction base="cm:DatoAN_Type"> <xs:maxLength value="1"/> </xs:restriction> </xs:simpleType> </xs:element> <xs:element name="FormatoErrato" type="cm:DatoCB_Type" minOccurs="0"/> <xs:element name="ProtIDmodErrato" type="cm:DatoCB_Type" minOccurs="0"/> <xs:element name="NumeroProtocollo"> <xs:simpleType> <xs:restriction base="cm:DatoAN_Type"> <xs:maxLength value="25"/> <xs:minLength value="18"/> </xs:restriction> </xs:simpleType> </xs:element> </xs:sequence> </xs:complexType> </xs:element> </pre>

element **Documento_SCE_Type/BanchePoste/NumProgPacco**

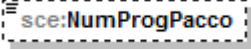
diagram					
namespace	urn:www.agenziaentrate.gov.it:specificheTecniche:sco:sce				
type	restriction of DatoNP_Type				
facets	<table border="1"> <thead> <tr> <th>Kind</th> <th>Value</th> </tr> </thead> <tbody> <tr> <td>pattern</td> <td>[1-9]{1}[0-9]*</td> </tr> </tbody> </table>	Kind	Value	pattern	[1-9]{1}[0-9]*
Kind	Value				
pattern	[1-9]{1}[0-9]*				
source	<pre><xs:element name="NumProgPacco" minOccurs="0"> <xs:simpleType> <xs:restriction base="cm:DatoNP_Type"> <xs:maxLength value="7"/> </xs:restriction> </xs:simpleType> </xs:element></pre>				

element **Documento_SCE_Type/BanchePoste/NumSeqDicIntPacco**

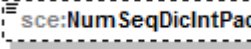
diagram					
namespace	urn:www.agenziaentrate.gov.it:specificheTecniche:sco:sce				
type	restriction of DatoNP_Type				
facets	<table border="1"> <thead> <tr> <th>Kind</th> <th>Value</th> </tr> </thead> <tbody> <tr> <td>pattern</td> <td>[1-9]{1}[0-9]*</td> </tr> </tbody> </table>	Kind	Value	pattern	[1-9]{1}[0-9]*
Kind	Value				
pattern	[1-9]{1}[0-9]*				
source	<pre><xs:element name="NumSeqDicIntPacco" minOccurs="0"> <xs:simpleType> <xs:restriction base="cm:DatoNP_Type"> <xs:maxLength value="3"/> </xs:restriction> </xs:simpleType> </xs:element></pre>				

element **Documento_SCE_Type/BanchePoste/CodCentroOperativo**

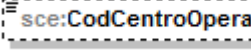
diagram					
namespace	urn:www.agenziaentrate.gov.it:specificheTecniche:sco:sce				
type	restriction of DatoAN_Type				
facets	<table border="1"> <thead> <tr> <th>Kind</th> <th>Value</th> </tr> </thead> <tbody> <tr> <td>pattern</td> <td>(([0-9A-Z-] \&quot;){1}([0-9A-Z&amp;:] \\- \\. , ! \" \\(\\) \\) À É È Ì Ò Ù Û &quot; \\ \\ \\ +)*</td> </tr> </tbody> </table>	Kind	Value	pattern	(([0-9A-Z-] \"){1}([0-9A-Z&:] \\- \\. , ! \" \\(\\) \\) À É È Ì Ò Ù Û " \\ \\ \\ +)*
Kind	Value				
pattern	(([0-9A-Z-] \"){1}([0-9A-Z&:] \\- \\. , ! \" \\(\\) \\) À É È Ì Ò Ù Û " \\ \\ \\ +)*				
source	<pre><xs:element name="CodCentroOperativo" minOccurs="0"> <xs:simpleType> <xs:restriction base="cm:DatoAN_Type"> <xs:maxLength value="1"/> </xs:restriction> </xs:simpleType> </xs:element></pre>				

element **Documento_SCE_Type/BanchePoste/FormatoErrato**

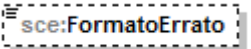
diagram	
namespace	urn:www.agenziaentrate.gov.it:specificheTecniche:sco:sce

type	DatoCB_Type
facets	Kind Value pattern [01]
source	<code><xs:element name="FormatoErrato" type="cm:DatoCB_Type" minOccurs="0"/></code>

element **Documento_SCE_Type/BanchePoste/ProtIDmodErrato**

diagram	
namespace	urn:www.agenziaentrate.gov.it:specificheTecniche:sco:sce
type	DatoCB_Type
facets	Kind Value pattern [01]
source	<code><xs:element name="ProtIDmodErrato" type="cm:DatoCB_Type" minOccurs="0"/></code>

element **Documento_SCE_Type/BanchePoste/NumeroProtocollo**

diagram	
namespace	urn:www.agenziaentrate.gov.it:specificheTecniche:sco:sce
type	restriction of DatoAN_Type
facets	Kind Value pattern (([0-9A-Z-]*)"){1}([0-9A-Z&:] ' - \., / "^\(\ \) À È É Ì Ò Ù Û " \N \\ +)*
source	<code><xs:element name="NumeroProtocollo"> <xs:simpleType> <xs:restriction base="cm:DatoAN_Type"> <xs:maxLength value="25"/> <xs:minLength value="18"/> </xs:restriction> </xs:simpleType> </xs:element></code>

complexType **Frontespizio_SCE_Type**

diagram	
namespace	urn:www.agenziaentrate.gov.it:specificheTecniche:sco:sce
children	sce:CodiceFiscale sce:DatiAnagrafici sce:Scelte
source	<code><xs:complexType name="Frontespizio_SCE_Type"> <xs:sequence> <xs:element name="CodiceFiscale" type="cm:DatoAN_Type" minOccurs="0"/> <xs:element name="DatiAnagrafici" type="sce:DatiAnagraficiScelte_Type" minOccurs="0"/> <xs:element name="Scelte" type="sce:Scelte_Type"/> </xs:sequence> </xs:complexType></code>

element **Frontespizio_SCE_Type/CodiceFiscale**

diagram	
namespace	urn:www.agenziaentrate.gov.it:specificheTecniche:sco:sce
type	DatoAN_Type
facets	Kind Value pattern ([0-9A-Z-] \"){1}([0-9A-Z&:] ' \- \., / ^ \^\(\\ \\) À É È Ì Ò Ù Û " \\ \\ \\ +)*
source	<xs:element name="CodiceFiscale" type="cm:DatoAN_Type" minOccurs="0"/>

element **Frontespizio_SCE_Type/DatiAnagrafici**

diagram	
namespace	urn:www.agenziaentrate.gov.it:specificheTecniche:sco:sce
type	sce:DatiAnagraficiScelte_Type
children	sce:Cognome sce:Nome sce:Sesso sce:DataNascita sce:ComuneNascita sce:ProvinciaNascita
source	<xs:element name="DatiAnagrafici" type="sce:DatiAnagraficiScelte_Type" minOccurs="0"/>

element **Frontespizio_SCE_Type/Scelte**

diagram	
namespace	urn:www.agenziaentrate.gov.it:specificheTecniche:sco:sce
type	sce:Scelte_Type
children	sce:Scelta5PerMille sce:Scelta8PerMille sce:Scelta2PerMille
source	<xs:element name="Scelte" type="sce:Scelte_Type"/>

complexType **Scelta2PerMille_Type**

diagram	
namespace	urn:www.agenziaentrate.gov.it:specificheTecniche:sco:sce
children	sce:Codice sce:Firma sce:SceltaNonEffettuata sce:Anomalia
source	<pre><xs:complexType name="Scelta2PerMille_Type"> <xs:sequence> <xs:element name="Codice" type="cm:DatoNP_Type" minOccurs="0"/> <xs:element name="Firma" type="cm:DatoCB_Type" minOccurs="0"/> <xs:element name="SceltaNonEffettuata" type="cm:DatoCB_Type" minOccurs="0"/> <xs:element name="Anomalia" type="cm:DatoN1_Type" minOccurs="0"/> </xs:sequence> </xs:complexType></pre>

element **Scelta2PerMille_Type/Codice**

diagram					
namespace	urn:www.agenziaentrate.gov.it:specificheTecniche:sco:sce				
type	DatoNP_Type				
facets	<table border="1"> <thead> <tr> <th>Kind</th> <th>Value</th> </tr> </thead> <tbody> <tr> <td>pattern</td> <td>[1-9]{1}[0-9]*</td> </tr> </tbody> </table>	Kind	Value	pattern	[1-9]{1}[0-9]*
Kind	Value				
pattern	[1-9]{1}[0-9]*				
source	<pre><xs:element name="Codice" type="cm:DatoNP_Type" minOccurs="0"/></pre>				

element **Scelta2PerMille_Type/Firma**

diagram					
namespace	urn:www.agenziaentrate.gov.it:specificheTecniche:sco:sce				
type	DatoCB_Type				
facets	<table border="1"> <thead> <tr> <th>Kind</th> <th>Value</th> </tr> </thead> <tbody> <tr> <td>pattern</td> <td>[01]</td> </tr> </tbody> </table>	Kind	Value	pattern	[01]
Kind	Value				
pattern	[01]				
source	<pre><xs:element name="Firma" type="cm:DatoCB_Type" minOccurs="0"/></pre>				

element **Scelta2PerMille_Type/SceltaNonEffettuata**

diagram					
namespace	urn:www.agenziaentrate.gov.it:specificheTecniche:sco:sce				
type	DatoCB_Type				
facets	<table border="1"> <thead> <tr> <th>Kind</th> <th>Value</th> </tr> </thead> <tbody> <tr> <td>pattern</td> <td>[01]</td> </tr> </tbody> </table>	Kind	Value	pattern	[01]
Kind	Value				
pattern	[01]				
source	<pre><xs:element name="SceltaNonEffettuata" type="cm:DatoCB_Type" minOccurs="0"/></pre>				

element **Scelta2PerMille_Type/Anomalia**

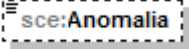
diagram	
namespace	urn:www.agenziaentrate.gov.it:specificheTecniche:sco:sce
type	DatoN1_Type
facets	Kind Value pattern [1-9]
source	<code><xs:element name="Anomalia" type="cm:DatoN1_Type" minOccurs="0"/></code>

complexType **Scelta5PerMille_Type**

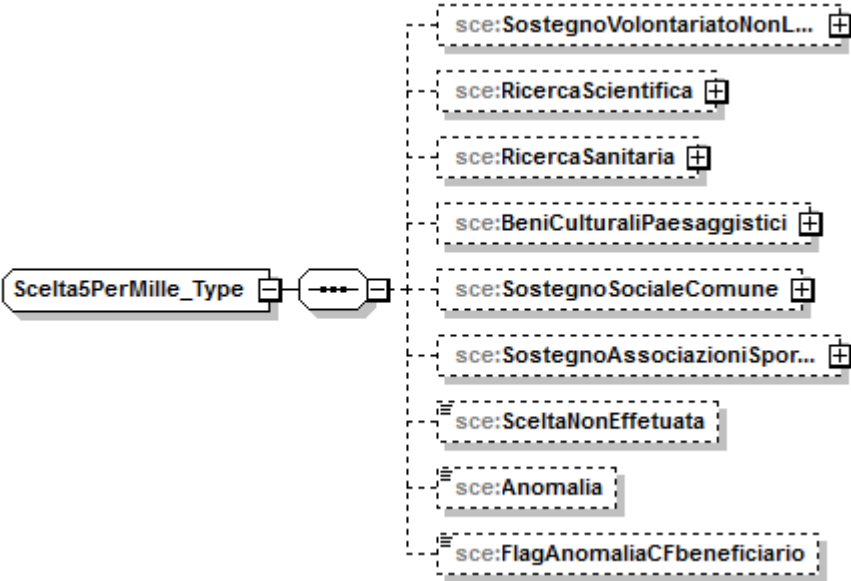
diagram	
namespace	urn:www.agenziaentrate.gov.it:specificheTecniche:sco:sce
children	sce:SostegnoVolontariatoNonLucrative sce:RicercaScientifica sce:RicercaSanitaria sce:BeniCulturaliPaesaggistici sce:SostegnoSocialeComune sce:SostegnoAssociazioniSportive sce:SceltaNonEffettuata sce:Anomalia sce:FlagAnomaliaCFbeneficiario
source	<pre><xs:complexType name="Scelta5PerMille_Type"> <xs:sequence> <xs:element name="SostegnoVolontariatoNonLucrative" type="sc:Firma_Type" minOccurs="0"/> <xs:element name="RicercaScientifica" type="sc:Firma_Type" minOccurs="0"/> <xs:element name="RicercaSanitaria" type="sc:Firma_Type" minOccurs="0"/> <xs:element name="BeniCulturaliPaesaggistici" minOccurs="0"> <xs:complexType> <xs:sequence> <xs:element name="Firma" type="cm:DatoCB_Type"/> </xs:sequence> </xs:complexType> </xs:element> <xs:element name="SostegnoSocialeComune" minOccurs="0"> <xs:complexType> <xs:sequence> <xs:element name="Firma" type="cm:DatoCB_Type"/> </xs:sequence> </xs:complexType> </xs:element> <xs:element name="SostegnoAssociazioniSportive" type="sc:Firma_Type" minOccurs="0"/> <xs:element name="SceltaNonEffettuata" type="cm:DatoCB_Type" minOccurs="0"/> <xs:element name="Anomalia" minOccurs="0"></pre>

	<pre> <xs:simpleType> <xs:restriction base="cm:DatoN1_Type"> <xs:enumeration value="1"/> <xs:enumeration value="2"/> <xs:enumeration value="3"/> <xs:enumeration value="4"/> <xs:enumeration value="5"/> </xs:restriction> </xs:simpleType> </xs:element> <xs:element name="FlagAnomaliaCFbeneficiario" type="cm:DatoCB_Type" minOccurs="0"/> </xs:sequence> </xs:complexType> </pre>
--	---

element **Scelta5PerMille_Type/SostegnoVolontariatoNonLucrative**

diagram	<p>The diagram shows a class <code>sc:Firma_Type</code> (yellow background) containing two subclasses: <code>Firma</code> and <code>CodiceFiscale</code>. A dashed box represents the class <code>sce:SostegnoVolontariatoNonL...</code>, which contains a reference to the <code>sc:Firma_Type</code> class.</p>
namespace	urn:www.agenziaentrate.gov.it:specificheTecniche:sco:sce
type	Firma_Type
children	Firma CodiceFiscale
source	<code><xs:element name="SostegnoVolontariatoNonLucrative" type="sc:Firma_Type" minOccurs="0"/></code>

element **Scelta5PerMille_Type/RicercaScientifica**

diagram	<p>The diagram shows a class <code>sc:Firma_Type</code> (yellow background) containing two subclasses: <code>Firma</code> and <code>CodiceFiscale</code>. A dashed box represents the class <code>sce:RicercaScientifica</code>, which contains a reference to the <code>sc:Firma_Type</code> class.</p>
namespace	urn:www.agenziaentrate.gov.it:specificheTecniche:sco:sce
type	Firma_Type
children	Firma CodiceFiscale
source	<code><xs:element name="RicercaScientifica" type="sc:Firma_Type" minOccurs="0"/></code>

element **Scelta5PerMille_Type/RicercaSanitaria**

diagram	<p>The diagram shows a class <code>sc:Firma_Type</code> (yellow background) containing two subclasses: <code>Firma</code> and <code>CodiceFiscale</code>. A dashed box represents the class <code>sce:RicercaSanitaria</code>, which contains a reference to the <code>sc:Firma_Type</code> class.</p>
namespace	urn:www.agenziaentrate.gov.it:specificheTecniche:sco:sce

type	Firma_Type
children	Firma CodiceFiscale
source	<xs:element name="RicercaSanitaria" type="sc:Firma_Type" minOccurs="0"/>

element **Scelta5PerMille_Type/BeniCulturaliPaesaggistici**

diagram	
namespace	urn:www.agenziaentrate.gov.it:specificheTecniche:sco:sce
children	sce:Firma
source	<xs:element name="BeniCulturaliPaesaggistici" minOccurs="0"> <xs:complexType> <xs:sequence> <xs:element name="Firma" type="cm:DatoCB_Type"/> </xs:sequence> </xs:complexType> </xs:element>

element **Scelta5PerMille_Type/BeniCulturaliPaesaggistici/Firma**

diagram	
namespace	urn:www.agenziaentrate.gov.it:specificheTecniche:sco:sce
type	DatoCB_Type
facets	Kind Value pattern [01]
source	<xs:element name="Firma" type="cm:DatoCB_Type"/>

element **Scelta5PerMille_Type/SostegnoSocialeComune**

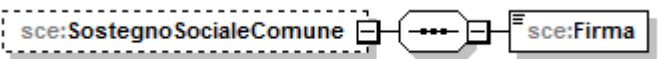
diagram	
namespace	urn:www.agenziaentrate.gov.it:specificheTecniche:sco:sce
children	sce:Firma
source	<xs:element name="SostegnoSocialeComune" minOccurs="0"> <xs:complexType> <xs:sequence> <xs:element name="Firma" type="cm:DatoCB_Type"/> </xs:sequence> </xs:complexType> </xs:element>

element **Scelta5PerMille_Type/SostegnoSocialeComune/Firma**

diagram	
namespace	urn:www.agenziaentrate.gov.it:specificheTecniche:sco:sce
type	DatoCB_Type
facets	Kind Value pattern [01]

source	<code><xs:element name="Firma" type="cm:DatoCB_Type"/></code>
--------	---

element **Scelta5PerMille_Type/SostegnoAssociazioniSportive**

diagram	
namespace	urn:www.agenziaentrate.gov.it:specificheTecniche:sco:sce
type	Firma_Type
children	Firma CodiceFiscale
source	<code><xs:element name="SostegnoAssociazioniSportive" type="sc:Firma_Type" minOccurs="0"/></code>

element **Scelta5PerMille_Type/SceltaNonEffettuata**

diagram					
namespace	urn:www.agenziaentrate.gov.it:specificheTecniche:sco:sce				
type	DatoCB_Type				
facets	<table border="1"> <thead> <tr> <th>Kind</th> <th>Value</th> </tr> </thead> <tbody> <tr> <td>pattern</td> <td>[01]</td> </tr> </tbody> </table>	Kind	Value	pattern	[01]
Kind	Value				
pattern	[01]				
source	<code><xs:element name="SceltaNonEffettuata" type="cm:DatoCB_Type" minOccurs="0"/></code>				

element **Scelta5PerMille_Type/Anomalia**

diagram															
namespace	urn:www.agenziaentrate.gov.it:specificheTecniche:sco:sce														
type	restriction of DatoN1_Type														
facets	<table border="1"> <thead> <tr> <th>Kind</th> <th>Value</th> </tr> </thead> <tbody> <tr> <td>pattern</td> <td>[1-9]</td> </tr> <tr> <td>enumeration</td> <td>1</td> </tr> <tr> <td>enumeration</td> <td>2</td> </tr> <tr> <td>enumeration</td> <td>3</td> </tr> <tr> <td>enumeration</td> <td>4</td> </tr> <tr> <td>enumeration</td> <td>5</td> </tr> </tbody> </table>	Kind	Value	pattern	[1-9]	enumeration	1	enumeration	2	enumeration	3	enumeration	4	enumeration	5
Kind	Value														
pattern	[1-9]														
enumeration	1														
enumeration	2														
enumeration	3														
enumeration	4														
enumeration	5														
source	<pre> <xs:element name="Anomalia" minOccurs="0"> <xs:simpleType> <xs:restriction base="cm:DatoN1_Type"> <xs:enumeration value="1"/> <xs:enumeration value="2"/> <xs:enumeration value="3"/> <xs:enumeration value="4"/> <xs:enumeration value="5"/> </xs:restriction> </xs:simpleType> </xs:element> </pre>														

element **Scelta5PerMille_Type/FlagAnomaliaCFbeneficiario**

diagram	
namespace	urn:www.agenziaentrate.gov.it:specificheTecniche:sco:sce
type	DatoCB_Type
facets	Kind Value pattern [01]
source	<code><xs:element name="FlagAnomaliaCFbeneficiario" type="cm:DatoCB_Type" minOccurs="0"/></code>

complexType **Scelta8PerMille_Type**

diagram	
namespace	urn:www.agenziaentrate.gov.it:specificheTecniche:sco:sce
children	sce:Stato sce:ChiesaCattolica sce:UnioneChieseCristianeAvventiste7giorno sce:AssembleeDiDioInItalia sce:UnioneDelleChieseMetodisteValdesi sce:ChiesaEvangelicaLuteranaInItalia sce:UnioneComunitaEbraicheItaliane sce:SacraArcidiocesiOrtodossaEsarcato sce:ChiesaApostolicaitalia sce:UnioneCristianaEvangelicaBattista sce:UnioneBuddhistaitaliana sce:UnioneInduistaitaliana sce:SceltaNonEffettuata sce:Anomalia
source	<code><xs:complexType name="Scelta8PerMille_Type"> <xs:sequence> <xs:element name="Stato" type="cm:DatoCB_Type" minOccurs="0"/> <xs:element name="ChiesaCattolica" type="cm:DatoCB_Type" minOccurs="0"/> <xs:element name="UnioneChieseCristianeAvventiste7giorno" type="cm:DatoCB_Type" minOccurs="0"/> <xs:element name="AssembleeDiDioInItalia" type="cm:DatoCB_Type" minOccurs="0"/> <xs:element name="UnioneDelleChieseMetodisteValdesi" type="cm:DatoCB_Type" minOccurs="0"/> <xs:element name="ChiesaEvangelicaLuteranaInItalia" type="cm:DatoCB_Type" minOccurs="0"/></code>

	<pre> <xs:element name="UnioneComunitaEbraicheItaliane" type="cm:DatoCB_Type" minOccurs="0"/> <xs:element name="SacraArcidiocesiOrtodossaEsarcato" type="cm:DatoCB_Type" minOccurs="0"/> <xs:element name="ChiesaApostolicaItalia" type="cm:DatoCB_Type" minOccurs="0"/> <xs:element name="UnioneCristianaEvangelicaBattista" type="cm:DatoCB_Type" minOccurs="0"/> <xs:element name="UnioneBuddhistaItaliana" type="cm:DatoCB_Type" minOccurs="0"/> <xs:element name="UnioneInduistaItaliana" type="cm:DatoCB_Type" minOccurs="0"/> <xs:element name="SceltaNonEffettuata" type="cm:DatoCB_Type" minOccurs="0"/> <xs:element name="Anomalia" minOccurs="0"> <xs:simpleType> <xs:restriction base="cm:DatoN1_Type"> <xs:enumeration value="1"/> <xs:enumeration value="2"/> <xs:enumeration value="3"/> </xs:restriction> </xs:simpleType> </xs:element> </xs:sequence> </xs:complexType> </pre>
--	--

element **Scelta8PerMille_Type/Stato**

diagram					
namespace	urn:www.agenziaentrate.gov.it:specificheTecniche:sco:sce				
type	DatoCB_Type				
facets	<table border="1"> <thead> <tr> <th>Kind</th> <th>Value</th> </tr> </thead> <tbody> <tr> <td>pattern</td> <td>[01]</td> </tr> </tbody> </table>	Kind	Value	pattern	[01]
Kind	Value				
pattern	[01]				
source	<code><xs:element name="Stato" type="cm:DatoCB_Type" minOccurs="0"/></code>				

element **Scelta8PerMille_Type/ChiesaCattolica**

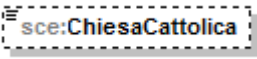
diagram					
namespace	urn:www.agenziaentrate.gov.it:specificheTecniche:sco:sce				
type	DatoCB_Type				
facets	<table border="1"> <thead> <tr> <th>Kind</th> <th>Value</th> </tr> </thead> <tbody> <tr> <td>pattern</td> <td>[01]</td> </tr> </tbody> </table>	Kind	Value	pattern	[01]
Kind	Value				
pattern	[01]				
source	<code><xs:element name="ChiesaCattolica" type="cm:DatoCB_Type" minOccurs="0"/></code>				

element **Scelta8PerMille_Type/UnioneChieseCristianeAvventiste7giorno**

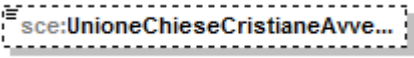
diagram					
namespace	urn:www.agenziaentrate.gov.it:specificheTecniche:sco:sce				
type	DatoCB_Type				
facets	<table border="1"> <thead> <tr> <th>Kind</th> <th>Value</th> </tr> </thead> <tbody> <tr> <td>pattern</td> <td>[01]</td> </tr> </tbody> </table>	Kind	Value	pattern	[01]
Kind	Value				
pattern	[01]				
source	<code><xs:element name="UnioneChieseCristianeAvventiste7giorno" type="cm:DatoCB_Type" minOccurs="0"/></code>				

element **Scelta8PerMille_Type/AssembleeDiDiolnItalia**

diagram	
---------	---

namespace	urn:www.agenziaentrate.gov.it:specificheTecniche:sco:sce
type	DatoCB_Type
facets	Kind Value pattern [01]
source	<xs:element name="AssembleeDiDiolnItalia" type="cm:DatoCB_Type" minOccurs="0"/>

element **Scelta8PerMille_Type/UnioneDelleChieseMetodisteValdesi**

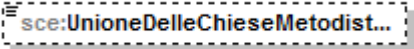
diagram	
namespace	urn:www.agenziaentrate.gov.it:specificheTecniche:sco:sce
type	DatoCB_Type
facets	Kind Value pattern [01]
source	<xs:element name="UnioneDelleChieseMetodisteValdesi" type="cm:DatoCB_Type" minOccurs="0"/>

element **Scelta8PerMille_Type/ChiesaEvangelicaLuteranaInItalia**

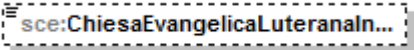
diagram	
namespace	urn:www.agenziaentrate.gov.it:specificheTecniche:sco:sce
type	DatoCB_Type
facets	Kind Value pattern [01]
source	<xs:element name="ChiesaEvangelicaLuteranaInItalia" type="cm:DatoCB_Type" minOccurs="0"/>

element **Scelta8PerMille_Type/UnioneComunitaEbraicheItaliane**

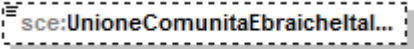
diagram	
namespace	urn:www.agenziaentrate.gov.it:specificheTecniche:sco:sce
type	DatoCB_Type
facets	Kind Value pattern [01]
source	<xs:element name="UnioneComunitaEbraicheItaliane" type="cm:DatoCB_Type" minOccurs="0"/>

element **Scelta8PerMille_Type/SacraArcidiocesiOrtodossaEsarcato**

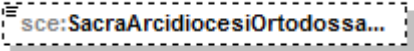
diagram	
namespace	urn:www.agenziaentrate.gov.it:specificheTecniche:sco:sce
type	DatoCB_Type
facets	Kind Value pattern [01]
source	<xs:element name="SacraArcidiocesiOrtodossaEsarcato" type="cm:DatoCB_Type" minOccurs="0"/>

element **Scelta8PerMille_Type/ChiesaApostolicaltalia**

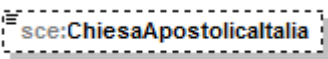
diagram	
namespace	urn:www.agenziaentrate.gov.it:specificheTecniche:sco:sce
type	DatoCB_Type
facets	Kind Value pattern [01]
source	<xs:element name="ChiesaApostolicaltalia" type="cm:DatoCB_Type" minOccurs="0"/>

element **Scelta8PerMille_Type/UnioneCristianaEvangelicaBattista**

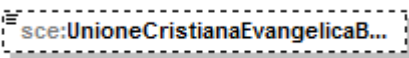
diagram	
namespace	urn:www.agenziaentrate.gov.it:specificheTecniche:sco:sce
type	DatoCB_Type
facets	Kind Value pattern [01]
source	<xs:element name="UnioneCristianaEvangelicaBattista" type="cm:DatoCB_Type" minOccurs="0"/>

element **Scelta8PerMille_Type/UnioneBuddhistaltaliana**

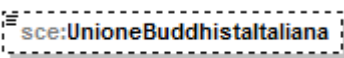
diagram	
namespace	urn:www.agenziaentrate.gov.it:specificheTecniche:sco:sce
type	DatoCB_Type
facets	Kind Value pattern [01]
source	<xs:element name="UnioneBuddhistaltaliana" type="cm:DatoCB_Type" minOccurs="0"/>

element **Scelta8PerMille_Type/UnioneInduistaltaliana**

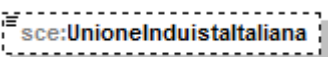
diagram	
namespace	urn:www.agenziaentrate.gov.it:specificheTecniche:sco:sce
type	DatoCB_Type
facets	Kind Value pattern [01]
source	<xs:element name="UnioneInduistaltaliana" type="cm:DatoCB_Type" minOccurs="0"/>

element **Scelta8PerMille_Type/SceltaNonEffettuata**

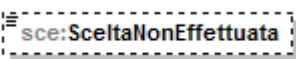
diagram	
namespace	urn:www.agenziaentrate.gov.it:specificheTecniche:sco:sce
type	DatoCB_Type
facets	Kind Value pattern [01]
source	<xs:element name="SceltaNonEffettuata" type="cm:DatoCB_Type" minOccurs="0"/>

element **Scelta8PerMille_Type/Anomalia**

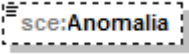
diagram											
namespace	urn:www.agenziaentrate.gov.it:specificheTecniche:sco:sce										
type	restriction of DatoN1_Type										
facets	<table border="1"> <thead> <tr> <th>Kind</th> <th>Value</th> </tr> </thead> <tbody> <tr> <td>pattern</td> <td>[1-9]</td> </tr> <tr> <td>enumeration</td> <td>1</td> </tr> <tr> <td>enumeration</td> <td>2</td> </tr> <tr> <td>enumeration</td> <td>3</td> </tr> </tbody> </table>	Kind	Value	pattern	[1-9]	enumeration	1	enumeration	2	enumeration	3
Kind	Value										
pattern	[1-9]										
enumeration	1										
enumeration	2										
enumeration	3										
source	<pre><xs:element name="Anomalia" minOccurs="0"> <xs:simpleType> <xs:restriction base="cm:DatoN1_Type"> <xs:enumeration value="1"/> <xs:enumeration value="2"/> <xs:enumeration value="3"/> </xs:restriction> </xs:simpleType> </xs:element></pre>										

complexType **Scelte_Type**

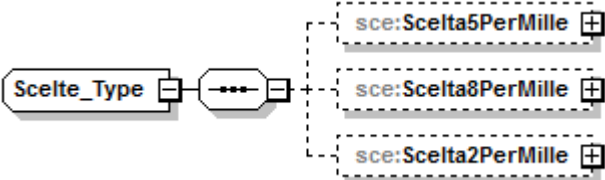
diagram	
namespace	urn:www.agenziaentrate.gov.it:specificheTecniche:sco:sce
children	sce:Scelta5PerMille sce:Scelta8PerMille sce:Scelta2PerMille
source	<pre><xs:complexType name="Scelte_Type"> <xs:sequence> <xs:element name="Scelta5PerMille" type="sce:Scelta5PerMille_Type" minOccurs="0"/> <xs:element name="Scelta8PerMille" type="sce:Scelta8PerMille_Type" minOccurs="0"/> <xs:element name="Scelta2PerMille" type="sce:Scelta2PerMille_Type" minOccurs="0"/> </xs:sequence> </xs:complexType></pre>

element **Scelte_Type/Scelta5PerMille**

<p>diagram</p>	
<p>namespace</p>	<p>urn:www.agenziaentrate.gov.it:specificheTecniche:sco:sce</p>
<p>type</p>	<p>sce:Scelta5PerMille_Type</p>
<p>children</p>	<p>sce:SostegnoVolontariatoNonLucrative sce:RicercaScientifica sce:RicercaSanitaria sce:BeniCulturaliPaesaggistici sce:SostegnoSocialeComune sce:SostegnoAssociazioniSportive sce:SceltaNonEffettuata sce:Anomalia sce:FlagAnomaliaCFbeneficiario</p>
<p>source</p>	<p><code><xs:element name="Scelta5PerMille" type="sce:Scelta5PerMille_Type" minOccurs="0"/></code></p>

element **Scelte_Type/Scelta8PerMille**

<p>diagram</p>	
<p>namespace</p>	<p>urn:www.agenziaentrate.gov.it:specificheTecniche:sco:sce</p>
<p>type</p>	<p>sce:Scelta8PerMille_Type</p>
<p>children</p>	<p>sce:Stato sce:ChiesaCattolica sce:UnioneChieseCristianeAvventiste7giorno sce:AssembleeDiDioInItalia sce:UnioneDelleChieseMetodisteValdesi sce:ChiesaEvangelicaLuteranaInItalia sce:UnioneComunitaEbraicheItaliane sce:SacraArcidiocesiOrtodossaEsarcato sce:ChiesaApostolicaItalia sce:UnioneCristianaEvangelicaBattista sce:UnioneBuddhistaitaliana sce:UnioneInduistaitaliana sce:SceltaNonEffettuata sce:Anomalia</p>
<p>source</p>	<p><xs:element name="Scelta8PerMille" type="sce:Scelta8PerMille_Type" minOccurs="0"/></p>

element **Scelte_Type/Scelta2PerMille**

diagram	
namespace	urn:www.agenziaentrate.gov.it:specificheTecniche:sco:sce
type	sce:Scelta2PerMille_Type
children	sce:Codice sce:Firma sce:SceltaNonEffettuata sce:Anomalia
source	<code><xs:element name="Scelta2PerMille" type="sce:Scelta2PerMille_Type" minOccurs="0"/></code>

simpleType **DatoAN_Type**

namespace	urn:www.agenziaentrate.gov.it:specificheTecniche:common				
type	restriction of xs:string				
facets	<table border="1"> <thead> <tr> <th>Kind</th> <th>Value</th> </tr> </thead> <tbody> <tr> <td>pattern</td> <td><code>([0-9A-Z-]*)&quot;{1}([0-9A-Z&amp;:] \- \., / \^\(\ \)\ À È É Ì Ò Ù Û &quot; \\ / +)*</code></td> </tr> </tbody> </table>	Kind	Value	pattern	<code>([0-9A-Z-]*)&quot;{1}([0-9A-Z&amp;:] \- \., / \^\(\ \)\ À È É Ì Ò Ù Û &quot; \\ / +)*</code>
Kind	Value				
pattern	<code>([0-9A-Z-]*)&quot;{1}([0-9A-Z&amp;:] \- \., / \^\(\ \)\ À È É Ì Ò Ù Û &quot; \\ / +)*</code>				
source	<pre> <xs:simpleType name="DatoAN_Type"> <xs:annotation> <xs:documentation>Tipo semplice costituito da caratteri alfanumerici maiuscoli e dai caratteri: punto, virgola, apice, trattino, spazio, barra semplice, °, ^, ampersand, parentesi aperta e chiusa, doppie virgolette, barra rovesciata, la barra dritta, il più, le maiuscole accentate e la Ü. Tali caratteri non sono ammessi come primo carattere tranne: i numeri da 0 a 9, i caratteri maiuscoli da A a Z, il meno e le doppie virgolette.</xs:documentation> </xs:annotation> <xs:restriction base="xs:string"> <xs:pattern value="([0-9A-Z-]*)&quot;{1}([0-9A-Z&amp;:] \- \., / \^\(\ \)\ À È É Ì Ò Ù Û &quot; \\ / +)*"/> </xs:restriction> </xs:simpleType> </pre>				

simpleType **DatoCB12_Type**

namespace	urn:www.agenziaentrate.gov.it:specificheTecniche:common				
type	restriction of xs:byte				
facets	<table border="1"> <thead> <tr> <th>Kind</th> <th>Value</th> </tr> </thead> <tbody> <tr> <td>pattern</td> <td><code>[10]{12}</code></td> </tr> </tbody> </table>	Kind	Value	pattern	<code>[10]{12}</code>
Kind	Value				
pattern	<code>[10]{12}</code>				
source	<pre> <xs:simpleType name="DatoCB12_Type"> <xs:annotation> <xs:documentation>Tipo semplice che consente esclusivamente 12 caratteri con i valori 0 e 1.</xs:documentation> </xs:annotation> <xs:restriction base="xs:byte"> <xs:pattern value="[10]{12}"/> </xs:restriction> </xs:simpleType> </pre>				

simpleType **DatoCB_Type**

namespace	urn:www.agenziaentrate.gov.it:specificheTecniche:common
type	restriction of xs:byte

facets	Kind Value pattern [01]
source	<pre><xs:simpleType name="DatoCB_Type"> <xs:annotation> <xs:documentation>Tipo semplice che consente esclusivamente i valori 0 e 1.</xs:documentation> </xs:annotation> <xs:restriction base="xs:byte"> <xs:pattern value="[01]" /> </xs:restriction> </xs:simpleType></pre>

simpleType DatoCF_Type

namespace	urn:www.agenziaentrate.gov.it:specificheTecniche:common
type	restriction of xs:string
facets	Kind Value pattern [0-9]{11}[A-Z]{6}[0-9LMNPQRSTUVWXYZ]{2}[A-Z]{1}[0-9LMNPQRSTUVWXYZ]{2}[A-Z]{1}[0-9LMNPQRSTUVWXYZ]{3}[A-Z]{1}
source	<pre><xs:simpleType name="DatoCF_Type"> <xs:annotation> <xs:documentation>Tipo semplice che identifica un codice fiscale provvisorio o alfanumerico rispettandone i vincoli di struttura.</xs:documentation> </xs:annotation> <xs:restriction base="xs:string"> <xs:pattern value="[0-9]{11}[A-Z]{6}[0-9LMNPQRSTUVWXYZ]{2}[A-Z]{1}[0-9LMNPQRSTUVWXYZ]{2}[A-Z]{1}[0-9LMNPQRSTUVWXYZ]{3}[A-Z]{1}" /> </xs:restriction> </xs:simpleType></pre>

simpleType DatoCN_Type

namespace	urn:www.agenziaentrate.gov.it:specificheTecniche:common
type	restriction of xs:string
facets	Kind Value pattern [0-9]{11}
source	<pre><xs:simpleType name="DatoCN_Type"> <xs:annotation> <xs:documentation>Tipo semplice che identifica un codice fiscale numerico rispettandone i vincoli di struttura.</xs:documentation> </xs:annotation> <xs:restriction base="xs:string"> <xs:length value="11" /> <xs:pattern value="[0-9]{11}" /> </xs:restriction> </xs:simpleType></pre>

simpleType DatoCP_Type

namespace	urn:www.agenziaentrate.gov.it:specificheTecniche:common
type	restriction of xs:string
facets	Kind Value pattern [0-9]{5}
source	<pre><xs:simpleType name="DatoCP_Type"> <xs:annotation> <xs:documentation>Tipo semplice che identifica un elemento di tipo cap</xs:documentation> </xs:annotation> <xs:restriction base="xs:string"> <xs:pattern value="[0-9]{5}" /> </xs:restriction> </xs:simpleType></pre>

simpleType **DatoD6_Type**

namespace	urn:www.agenziaentrate.gov.it:specificheTecniche:common				
type	restriction of xs:string				
facets	<table border="1"> <thead> <tr> <th>Kind</th> <th>Value</th> </tr> </thead> <tbody> <tr> <td>pattern</td> <td>((0[0-9]) (1[0-2]))((19 20)[0-9][0-9])</td> </tr> </tbody> </table>	Kind	Value	pattern	((0[0-9]) (1[0-2]))((19 20)[0-9][0-9])
Kind	Value				
pattern	((0[0-9]) (1[0-2]))((19 20)[0-9][0-9])				
source	<pre><xs:simpleType name="DatoD6_Type"> <xs:annotation> <xs:documentation>Tipo semplice che identifica una data nel formato mmaaaa.</xs:documentation> </xs:annotation> <xs:restriction base="xs:string"> <xs:length value="6"/> <xs:pattern value="((0[0-9]) (1[0-2]))((19 20)[0-9][0-9])"/> </xs:restriction> </xs:simpleType></pre>				

simpleType **DatoDA_Type**

namespace	urn:www.agenziaentrate.gov.it:specificheTecniche:common				
type	restriction of xs:string				
facets	<table border="1"> <thead> <tr> <th>Kind</th> <th>Value</th> </tr> </thead> <tbody> <tr> <td>pattern</td> <td>(18 19 20)[0-9]{2}</td> </tr> </tbody> </table>	Kind	Value	pattern	(18 19 20)[0-9]{2}
Kind	Value				
pattern	(18 19 20)[0-9]{2}				
source	<pre><xs:simpleType name="DatoDA_Type"> <xs:annotation> <xs:documentation>Tipo semplice che identifica un anno nel formato aaaa. Sono ammessi anni dal 1800 al 2099.</xs:documentation> </xs:annotation> <xs:restriction base="xs:string"> <xs:length value="4"/> <xs:pattern value="(18 19 20)[0-9]{2}"/> </xs:restriction> </xs:simpleType></pre>				

simpleType **DatoDN_Type**

namespace	urn:www.agenziaentrate.gov.it:specificheTecniche:common				
type	restriction of xs:string				
facets	<table border="1"> <thead> <tr> <th>Kind</th> <th>Value</th> </tr> </thead> <tbody> <tr> <td>pattern</td> <td>((([0-9][1-9][12][0-9][301]) (0[13578][10]12)\d{4}))((([0][1-9][12][0-9][30](0[469][11]\d{4})) ((0[1-9][1[0-9]]2[0-8])(02)\d{4})) ((29)(02)([02468][048]00)) ((29)(02)([13579][26]00)) ((29)(02)([0-9][0-9][0][48])) ((29)(02)([0-9][0-9][2468][048])) ((29)(02)([0-9][0-9][13579][26]))))</td> </tr> </tbody> </table>	Kind	Value	pattern	((([0-9][1-9][12][0-9][301]) (0[13578][10]12)\d{4}))((([0][1-9][12][0-9][30](0[469][11]\d{4})) ((0[1-9][1[0-9]]2[0-8])(02)\d{4})) ((29)(02)([02468][048]00)) ((29)(02)([13579][26]00)) ((29)(02)([0-9][0-9][0][48])) ((29)(02)([0-9][0-9][2468][048])) ((29)(02)([0-9][0-9][13579][26]))))
Kind	Value				
pattern	((([0-9][1-9][12][0-9][301]) (0[13578][10]12)\d{4}))((([0][1-9][12][0-9][30](0[469][11]\d{4})) ((0[1-9][1[0-9]]2[0-8])(02)\d{4})) ((29)(02)([02468][048]00)) ((29)(02)([13579][26]00)) ((29)(02)([0-9][0-9][0][48])) ((29)(02)([0-9][0-9][2468][048])) ((29)(02)([0-9][0-9][13579][26]))))				
source	<pre><xs:simpleType name="DatoDN_Type"> <xs:annotation> <xs:documentation>Tipo semplice che identifica una data nel formato ggmmaaaa.</xs:documentation> </xs:annotation> <xs:restriction base="xs:string"> <xs:length value="8"/> <xs:pattern value="(((0[1-9][12][0-9][301]) (0[13578][10]12)\d{4}))((([0][1-9][12][0-9][30](0[469][11]\d{4})) ((0[1-9][1[0-9]]2[0-8])(02)\d{4})) ((29)(02)([02468][048]00)) ((29)(02)([13579][26]00)) ((29)(02)([0-9][0-9][0][48])) ((29)(02)([0-9][0-9][2468][048])) ((29)(02)([0-9][0-9][13579][26]))))"/> </xs:restriction> </xs:simpleType></pre>				

simpleType **DatoDT_Type**

namespace	urn:www.agenziaentrate.gov.it:specificheTecniche:common				
type	restriction of xs:string				
facets	<table border="1"> <thead> <tr> <th>Kind</th> <th>Value</th> </tr> </thead> <tbody> <tr> <td>pattern</td> <td>((([0-9][1-9][12][0-9][301]) (0[13578][10]12)\d{4}))((([0][1-9][12][0-9][30](0[469][11]\d{4})) ((0[1-9][1[0-9]]2[0-8])(02)\d{4})) ((29)(02)([02468][048]00)) ((29)(02)([13579][26]00)) ((29)(02)([0-9][0-9][0][48])) ((29)(02)([0-9][0-9][2468][048])) ((29)(02)([0-9][0-9][13579][26]))))</td> </tr> </tbody> </table>	Kind	Value	pattern	((([0-9][1-9][12][0-9][301]) (0[13578][10]12)\d{4}))((([0][1-9][12][0-9][30](0[469][11]\d{4})) ((0[1-9][1[0-9]]2[0-8])(02)\d{4})) ((29)(02)([02468][048]00)) ((29)(02)([13579][26]00)) ((29)(02)([0-9][0-9][0][48])) ((29)(02)([0-9][0-9][2468][048])) ((29)(02)([0-9][0-9][13579][26]))))
Kind	Value				
pattern	((([0-9][1-9][12][0-9][301]) (0[13578][10]12)\d{4}))((([0][1-9][12][0-9][30](0[469][11]\d{4})) ((0[1-9][1[0-9]]2[0-8])(02)\d{4})) ((29)(02)([02468][048]00)) ((29)(02)([13579][26]00)) ((29)(02)([0-9][0-9][0][48])) ((29)(02)([0-9][0-9][2468][048])) ((29)(02)([0-9][0-9][13579][26]))))				

source	<pre><xs:simpleType name="DatoDT_Type"> <xs:annotation> <xs:documentation>Tipo semplice che identifica una data nel formato ggmmaaaa. La data indicata non deve essere successiva alla data corrente.</xs:documentation> </xs:annotation> <xs:restriction base="xs:string"> <xs:length value="8"/> <xs:pattern value="(((0[1-9][12][0-9][3][01])(0[13578][10][12](\d{4})) ((0[1-9][12][0-9][30](0[469][11](\d{4})) ((0[1-9][10-9][2][0-8])(02)(\d{4})) ((29)(02)([02468][048]00)) ((29)(02)([13579][26]00)) ((29)(02)([0-9][0][48])) ((29)(02)([0-9][0-9][2468][048])) ((29)(02)([0-9][0-9][13579][26])))))/> </xs:restriction> </xs:simpleType></pre>
--------	--

simpleType DatoEM_Type

namespace	urn:www.agenziaentrate.gov.it:specificheTecniche:common				
type	restriction of xs:string				
facets	<table border="1"> <thead> <tr> <th>Kind</th> <th>Value</th> </tr> </thead> <tbody> <tr> <td>pattern</td> <td>[a-zA-Z0-9_%\-'&quot;?^~=]+@[a-zA-Z0-9\.\-]+\.[a-zA-Z]{2,4}</td> </tr> </tbody> </table>	Kind	Value	pattern	[a-zA-Z0-9_%\-'"?^~=]+@[a-zA-Z0-9\.\-]+\.[a-zA-Z]{2,4}
Kind	Value				
pattern	[a-zA-Z0-9_%\-'"?^~=]+@[a-zA-Z0-9\.\-]+\.[a-zA-Z]{2,4}				
source	<pre><xs:simpleType name="DatoEM_Type"> <xs:annotation> <xs:documentation>Tipo semplice che identifica un elemento di tipo email</xs:documentation> </xs:annotation> <xs:restriction base="xs:string"> <xs:pattern value="[a-zA-Z0-9_%\-'&quot;?^~=]+@[a-zA-Z0-9\.\-]+\.[a-zA-Z]{2,4}"/> </xs:restriction> </xs:simpleType></pre>				

simpleType DatoGA_Type

namespace	urn:www.agenziaentrate.gov.it:specificheTecniche:common				
type	restriction of xs:string				
facets	<table border="1"> <thead> <tr> <th>Kind</th> <th>Value</th> </tr> </thead> <tbody> <tr> <td>pattern</td> <td>[1-9]((1-9)[0-9]) ((12)[0-9][0-9]) (3[0-5][0-9]) (36[0-5])</td> </tr> </tbody> </table>	Kind	Value	pattern	[1-9]((1-9)[0-9]) ((12)[0-9][0-9]) (3[0-5][0-9]) (36[0-5])
Kind	Value				
pattern	[1-9]((1-9)[0-9]) ((12)[0-9][0-9]) (3[0-5][0-9]) (36[0-5])				
source	<pre><xs:simpleType name="DatoGA_Type"> <xs:annotation> <xs:documentation>Tipo semplice che identifica il numero di giorni in un anno e va da 1 a 365</xs:documentation> </xs:annotation> <xs:restriction base="xs:string"> <xs:minLength value="1"/> <xs:maxLength value="3"/> <xs:pattern value="[1-9]((1-9)[0-9]) ((12)[0-9][0-9]) (3[0-5][0-9]) (36[0-5])"/> </xs:restriction> </xs:simpleType></pre>				

simpleType DatoN1_Type

namespace	urn:www.agenziaentrate.gov.it:specificheTecniche:common				
type	restriction of xs:string				
facets	<table border="1"> <thead> <tr> <th>Kind</th> <th>Value</th> </tr> </thead> <tbody> <tr> <td>pattern</td> <td>[1-9]</td> </tr> </tbody> </table>	Kind	Value	pattern	[1-9]
Kind	Value				
pattern	[1-9]				
source	<pre><xs:simpleType name="DatoN1_Type"> <xs:annotation> <xs:documentation>Tipo semplice che identifica i numeri naturali da 1 a 9.</xs:documentation> </xs:annotation> <xs:restriction base="xs:string"> <xs:maxLength value="1"/> <xs:pattern value="[1-9]"/> </xs:restriction> </xs:simpleType></pre>				

simpleType DatoNP_Type

namespace	urn:www.agenziaentrate.gov.it:specificheTecniche:common				
type	restriction of xs:string				
facets	<table border="1"> <tr> <td>Kind</td> <td>Value</td> </tr> <tr> <td>pattern</td> <td>[1-9]{1}[0-9]*</td> </tr> </table>	Kind	Value	pattern	[1-9]{1}[0-9]*
Kind	Value				
pattern	[1-9]{1}[0-9]*				
source	<pre><xs:simpleType name="DatoNP_Type"> <xs:annotation> <xs:documentation>Tipo semplice che identifica numeri naturali positivi con al massimo 16 cifre.</xs:documentation> </xs:annotation> <xs:restriction base="xs:string"> <xs:pattern value="[1-9]{1}[0-9]*"/> </xs:restriction> </xs:simpleType></pre>				

simpleType DatoNU_Type

namespace	urn:www.agenziaentrate.gov.it:specificheTecniche:common				
type	restriction of xs:string				
facets	<table border="1"> <tr> <td>Kind</td> <td>Value</td> </tr> <tr> <td>pattern</td> <td>(\-[1-9] [1-9])[0-9]*</td> </tr> </table>	Kind	Value	pattern	(\-[1-9] [1-9])[0-9]*
Kind	Value				
pattern	(\-[1-9] [1-9])[0-9]*				
source	<pre><xs:simpleType name="DatoNU_Type"> <xs:annotation> <xs:documentation>Tipo semplice che identifica numeri naturali positivi e negativi con al massimo 16 cifre.</xs:documentation> </xs:annotation> <xs:restriction base="xs:string"> <xs:maxLength value="16"/> <xs:pattern value="(\-[1-9] [1-9])[0-9]*"/> </xs:restriction> </xs:simpleType></pre>				

simpleType DatoPC_Type

namespace	urn:www.agenziaentrate.gov.it:specificheTecniche:common				
type	restriction of xs:string				
facets	<table border="1"> <tr> <td>Kind</td> <td>Value</td> </tr> <tr> <td>pattern</td> <td>[0-9]?[0-9](,\d{1,3})? 100,(0{1,3})?</td> </tr> </table>	Kind	Value	pattern	[0-9]?[0-9](,\d{1,3})? 100,(0{1,3})?
Kind	Value				
pattern	[0-9]?[0-9](,\d{1,3})? 100,(0{1,3})?				
source	<pre><xs:simpleType name="DatoPC_Type"> <xs:annotation> <xs:documentation>Tipo semplice che esprime una percentuale e dunque consente valori positivi non superiori a 100, con al massimo 2 cifre decimali. Il separatore decimale previsto è la virgola.</xs:documentation> </xs:annotation> <xs:restriction base="xs:string"> <xs:maxLength value="16"/> <xs:pattern value="[0-9]?[0-9](,\d{1,3})? 100,(0{1,3})?"/> </xs:restriction> </xs:simpleType></pre>				

simpleType DatoPI_Type

namespace	urn:www.agenziaentrate.gov.it:specificheTecniche:common				
type	restriction of xs:string				
facets	<table border="1"> <tr> <td>Kind</td> <td>Value</td> </tr> <tr> <td>pattern</td> <td>[0-7][0-9]{10}</td> </tr> </table>	Kind	Value	pattern	[0-7][0-9]{10}
Kind	Value				
pattern	[0-7][0-9]{10}				
source	<pre><xs:simpleType name="DatoPI_Type"> <xs:annotation> <xs:documentation>Tipo semplice che identifica la partita IVA rispettandone i vincoli di struttura. </xs:documentation> </xs:annotation> </xs:simpleType></pre>				

	<pre> <xs:restriction base="xs:string"> <xs:length value="11"/> <xs:pattern value="[0-7][0-9]{10}"/> </xs:restriction> </xs:simpleType> </pre>
--	--

simpleType **DatoQU_Type**

namespace	urn:www.agenziaentrate.gov.it:specificheTecniche:common				
type	restriction of xs:string				
facets	<table border="1"> <tr> <th>Kind</th> <th>Value</th> </tr> <tr> <td>pattern</td> <td>[0-9]+,[0-9]{1,5}?</td> </tr> </table>	Kind	Value	pattern	[0-9]+,[0-9]{1,5}?
Kind	Value				
pattern	[0-9]+,[0-9]{1,5}?				
source	<pre> <xs:simpleType name="DatoQU_Type"> <xs:annotation> <xs:documentation>Tipo semplice che identifica numeri positivi con al massimo 5 cifre decimali. La lunghezza massima prevista è di 16 caratteri, il separatore decimale previsto è la virgola.</xs:documentation> </xs:annotation> <xs:restriction base="xs:string"> <xs:maxLength value="16"/> <xs:pattern value="[0-9]+,[0-9]{1,5}?" /> </xs:restriction> </xs:simpleType> </pre>				

simpleType **DatoTL_Type**

namespace	urn:www.agenziaentrate.gov.it:specificheTecniche:common				
type	restriction of xs:string				
facets	<table border="1"> <tr> <th>Kind</th> <th>Value</th> </tr> <tr> <td>pattern</td> <td>[0-9]*</td> </tr> </table>	Kind	Value	pattern	[0-9]*
Kind	Value				
pattern	[0-9]*				
source	<pre> <xs:simpleType name="DatoTL_Type"> <xs:annotation> <xs:documentation>Tipo semplice che identifica un elemento di tipo telefono</xs:documentation> </xs:annotation> <xs:restriction base="xs:string"> <xs:pattern value="[0-9]*" /> </xs:restriction> </xs:simpleType> </pre>				

simpleType **DatoVP_Type**

namespace	urn:www.agenziaentrate.gov.it:specificheTecniche:common				
type	restriction of xs:string				
facets	<table border="1"> <tr> <th>Kind</th> <th>Value</th> </tr> <tr> <td>pattern</td> <td>[0-9]+,[0-9]{2}</td> </tr> </table>	Kind	Value	pattern	[0-9]+,[0-9]{2}
Kind	Value				
pattern	[0-9]+,[0-9]{2}				
source	<pre> <xs:simpleType name="DatoVP_Type"> <xs:annotation> <xs:documentation>Tipo semplice che identifica numeri positivi con 2 cifre decimali. La lunghezza massima prevista è di 16 caratteri, il separatore decimale previsto è la virgola.</xs:documentation> </xs:annotation> <xs:restriction base="xs:string"> <xs:maxLength value="16"/> <xs:pattern value="[0-9]+,[0-9]{2}" /> </xs:restriction> </xs:simpleType> </pre>				

simpleType **Casella_Quadro_Type**

namespace	urn:www.agenziaentrate.gov.it:specificheTecniche:sco:common
type	restriction of DatoAN_Type

facets	Kind	Value
	pattern	([0-9A-Z\-\]]"){1}([0-9A-Z&]] \- \. / ° \^\(\))À È É ì Ò Ù Ü " \ \\ \+)*
	enumeration	0
	enumeration	1
	enumeration	2
	enumeration	3
source	<pre><xs:simpleType name="Casella_Quadro_Type"> <xs:restriction base="cm:DatoAN_Type"> <xs:enumeration value="0"/> <xs:enumeration value="1"/> <xs:enumeration value="2"/> <xs:enumeration value="3"/> </xs:restriction> </xs:simpleType></pre>	

simpleType Codice_Carica_Type

namespace	urn:www.agenziaentrate.gov.it:specificheTecniche:sco:common	
type	restriction of DatoNP_Type	
facets	Kind	Value
	pattern	[1-9]{1}[0-9]*
	enumeration	1
	enumeration	2
	enumeration	3
	enumeration	4
	enumeration	5
	enumeration	6
	enumeration	7
	enumeration	8
	enumeration	9
	enumeration	10
	enumeration	11
	enumeration	12
	enumeration	13
	enumeration	14
	enumeration	15
source	<pre><xs:simpleType name="Codice_Carica_Type"> <xs:annotation> <xs:documentation>Tabella generale dei codici carica</xs:documentation> </xs:annotation> <xs:restriction base="cm:DatoNP_Type"> <xs:enumeration value="1"> <xs:annotation> <xs:documentation>Rappresentante legale, negoziale o di fatto, socio amministratore</xs:documentation> </xs:annotation> </xs:enumeration> <xs:enumeration value="2"> <xs:annotation> <xs:documentation><![CDATA[Rappresentante di minore, inabilitato o interdetto, amministratore di sostegno, ovvero curatore dell'eredità giacente, amministratore dell'eredità]]></xs:documentation> </xs:annotation> </xs:enumeration> <xs:enumeration value="3"> <xs:annotation> <xs:documentation>Curatore fallimentare</xs:documentation> </xs:annotation> </xs:enumeration> <xs:enumeration value="4"> <xs:annotation> <xs:documentation>Commissario liquidatore</xs:documentation> </xs:annotation> </xs:enumeration> <xs:enumeration value="5"> <xs:annotation> <xs:documentation>Commissario giudiziale</xs:documentation> </xs:annotation> </xs:enumeration> </xs:restriction> </xs:simpleType></pre>	

	<pre> <xs:enumeration value="6"> <xs:annotation> <xs:documentation><![CDATA[Rappresentante fiscale di soggetto non residente]]></xs:documentation> </xs:annotation> </xs:enumeration> <xs:enumeration value="7"> <xs:annotation> <xs:documentation>Erede</xs:documentation> </xs:annotation> </xs:enumeration> <xs:enumeration value="8"> <xs:annotation> <xs:documentation><![CDATA[Liquidatore - liquidazione volontaria]]></xs:documentation> </xs:annotation> </xs:enumeration> <xs:enumeration value="9"> <xs:annotation> <xs:documentation><![CDATA[Soggetto tenuto a presentare dichiarazione in caso di operazioni straordinarie]]></xs:documentation> </xs:annotation> </xs:enumeration> <xs:enumeration value="10"> <xs:annotation> <xs:documentation><![CDATA[Rappresentante fiscale di soggetto non residente con le limitazioni di cui all'art. 44, comma 3, del D.L. n.331/1993]]></xs:documentation> </xs:annotation> </xs:enumeration> <xs:enumeration value="11"> <xs:annotation> <xs:documentation><![CDATA[Soggetto esercente l'attività tutoria del minore o interdetto in relazione alla funzione istituzionale rivestita]]></xs:documentation> </xs:annotation> </xs:enumeration> <xs:enumeration value="12"> <xs:annotation> <xs:documentation><![CDATA[Liquidatore - liquidazione volontaria di ditta individuale periodo ante messa in liquidazione]]></xs:documentation> </xs:annotation> </xs:enumeration> <xs:enumeration value="13"> <xs:annotation> <xs:documentation>Amministratore di condominio</xs:documentation> </xs:annotation> </xs:enumeration> <xs:enumeration value="14"> <xs:annotation> <xs:documentation><![CDATA[Soggetto che sottoscrive la dichiarazione per conto di una pubblica amministrazione]]></xs:documentation> </xs:annotation> </xs:enumeration> <xs:enumeration value="15"> <xs:annotation> <xs:documentation><![CDATA[Commissario liquidatore di una pubblica amministrazione]]></xs:documentation> </xs:annotation> </xs:enumeration> </xs:restriction> </xs:simpleType> </pre>
--	--

simpleType **Codice_Regione_Type**

namespace	urn:www.agenziaentrate.gov.it:specificheTecniche:sco:common												
type	restriction of DatoAN_Type												
facets	<table border="1"> <thead> <tr> <th>Kind</th> <th>Value</th> </tr> </thead> <tbody> <tr> <td>pattern</td> <td>([0-9A-Z\-\ &quot;]{1}{[0-9A-Z&amp;:] '\-\. , /° ^\(\ \) À È É Ì Ò Ù Û &quot; \ \ \+)*</td> </tr> <tr> <td>enumeration</td> <td>1</td> </tr> <tr> <td>enumeration</td> <td>2</td> </tr> <tr> <td>enumeration</td> <td>3</td> </tr> <tr> <td>enumeration</td> <td>4</td> </tr> </tbody> </table>	Kind	Value	pattern	([0-9A-Z\-\ "]{1}{[0-9A-Z&:] '\-\. , /° ^\(\ \) À È É Ì Ò Ù Û " \ \ \+)*	enumeration	1	enumeration	2	enumeration	3	enumeration	4
Kind	Value												
pattern	([0-9A-Z\-\ "]{1}{[0-9A-Z&:] '\-\. , /° ^\(\ \) À È É Ì Ò Ù Û " \ \ \+)*												
enumeration	1												
enumeration	2												
enumeration	3												
enumeration	4												

	enumeration 5 enumeration 6 enumeration 7 enumeration 8 enumeration 9 enumeration 10 enumeration 11 enumeration 12 enumeration 13 enumeration 14 enumeration 15 enumeration 16 enumeration 17 enumeration 18 enumeration 19 enumeration 20 enumeration 21
source	<pre> <xs:simpleType name="Codice_Regione_Type"> <xs:restriction base="cm:DatoAN_Type"> <xs:enumeration value="1"/> <xs:enumeration value="2"/> <xs:enumeration value="3"/> <xs:enumeration value="4"/> <xs:enumeration value="5"/> <xs:enumeration value="6"/> <xs:enumeration value="7"/> <xs:enumeration value="8"/> <xs:enumeration value="9"/> <xs:enumeration value="10"/> <xs:enumeration value="11"/> <xs:enumeration value="12"/> <xs:enumeration value="13"/> <xs:enumeration value="14"/> <xs:enumeration value="15"/> <xs:enumeration value="16"/> <xs:enumeration value="17"/> <xs:enumeration value="18"/> <xs:enumeration value="19"/> <xs:enumeration value="20"/> <xs:enumeration value="21"/> </xs:restriction> </xs:simpleType> </pre>

simpleType **Natura_Giuridica_Type**

namespace	urn:www.agenziaentrate.gov.it:specificheTecniche:sco:common																																								
type	restriction of DatoNP_Type																																								
facets	<table border="1"> <thead> <tr> <th>Kind</th> <th>Value</th> </tr> </thead> <tbody> <tr> <td>pattern</td> <td>[1-9]{1}[0-9]*</td> </tr> <tr> <td>enumeration</td> <td>1</td> </tr> <tr> <td>enumeration</td> <td>2</td> </tr> <tr> <td>enumeration</td> <td>3</td> </tr> <tr> <td>enumeration</td> <td>4</td> </tr> <tr> <td>enumeration</td> <td>5</td> </tr> <tr> <td>enumeration</td> <td>6</td> </tr> <tr> <td>enumeration</td> <td>7</td> </tr> <tr> <td>enumeration</td> <td>8</td> </tr> <tr> <td>enumeration</td> <td>9</td> </tr> <tr> <td>enumeration</td> <td>10</td> </tr> <tr> <td>enumeration</td> <td>11</td> </tr> <tr> <td>enumeration</td> <td>12</td> </tr> <tr> <td>enumeration</td> <td>13</td> </tr> <tr> <td>enumeration</td> <td>14</td> </tr> <tr> <td>enumeration</td> <td>15</td> </tr> <tr> <td>enumeration</td> <td>16</td> </tr> <tr> <td>enumeration</td> <td>17</td> </tr> <tr> <td>enumeration</td> <td>18</td> </tr> </tbody> </table>	Kind	Value	pattern	[1-9]{1}[0-9]*	enumeration	1	enumeration	2	enumeration	3	enumeration	4	enumeration	5	enumeration	6	enumeration	7	enumeration	8	enumeration	9	enumeration	10	enumeration	11	enumeration	12	enumeration	13	enumeration	14	enumeration	15	enumeration	16	enumeration	17	enumeration	18
Kind	Value																																								
pattern	[1-9]{1}[0-9]*																																								
enumeration	1																																								
enumeration	2																																								
enumeration	3																																								
enumeration	4																																								
enumeration	5																																								
enumeration	6																																								
enumeration	7																																								
enumeration	8																																								
enumeration	9																																								
enumeration	10																																								
enumeration	11																																								
enumeration	12																																								
enumeration	13																																								
enumeration	14																																								
enumeration	15																																								
enumeration	16																																								
enumeration	17																																								
enumeration	18																																								

	enumeration 19 enumeration 20 enumeration 21 enumeration 22 enumeration 23 enumeration 24 enumeration 25 enumeration 26 enumeration 27 enumeration 28 enumeration 29 enumeration 30 enumeration 31 enumeration 32 enumeration 33 enumeration 34 enumeration 35 enumeration 36 enumeration 37 enumeration 38 enumeration 39 enumeration 40 enumeration 41 enumeration 42 enumeration 43 enumeration 44 enumeration 45 enumeration 50 enumeration 51 enumeration 52 enumeration 53 enumeration 54 enumeration 55 enumeration 56 enumeration 57 enumeration 58 enumeration 59
source	<pre> <xs:simpleType name="Natura_Giuridica_Type"> <xs:annotation> <xs:documentation>Tabella generale classificazione natura giuridica</xs:documentation> </xs:annotation> <xs:restriction base="cm:DatoNP_Type"> <xs:enumeration value="1"> <xs:annotation> <xs:documentation><![CDATA[Società in accomandita per azioni]]></xs:documentation> </xs:annotation> </xs:enumeration> <xs:enumeration value="2"> <xs:annotation> <xs:documentation><![CDATA[Società a responsabilità limitata]]></xs:documentation> </xs:annotation> </xs:enumeration> <xs:enumeration value="3"> <xs:annotation> <xs:documentation><![CDATA[Società per azioni]]></xs:documentation> </xs:annotation> </xs:enumeration> <xs:enumeration value="4"> <xs:annotation> <xs:documentation><![CDATA[Società cooperative e loro consorzi iscritti nei registri prefettizi e nello schedario della cooperazione]]></xs:documentation> </xs:annotation> </xs:enumeration> <xs:enumeration value="5"> <xs:annotation> <xs:documentation><![CDATA[Altre società cooperative]]></xs:documentation> </xs:annotation> </xs:enumeration> <xs:enumeration value="6"> </pre>

```
<xs:annotation>
  <xs:documentation><![CDATA[Mutue assicuratrici]]></xs:documentation>
</xs:annotation>
</xs:enumeration>
<xs:enumeration value="7">
  <xs:annotation>
    <xs:documentation><![CDATA[ConSORZI con personalità giuridica]]></xs:documentation>
  </xs:annotation>
</xs:enumeration>
<xs:enumeration value="8">
  <xs:annotation>
    <xs:documentation><![CDATA[Associazioni riconosciute]]></xs:documentation>
  </xs:annotation>
</xs:enumeration>
<xs:enumeration value="9">
  <xs:annotation>
    <xs:documentation><![CDATA[Fondazioni]]></xs:documentation>
  </xs:annotation>
</xs:enumeration>
<xs:enumeration value="10">
  <xs:annotation>
    <xs:documentation><![CDATA[Altri enti ed istituti con personalità giuridica]]></xs:documentation>
  </xs:annotation>
</xs:enumeration>
<xs:enumeration value="11">
  <xs:annotation>
    <xs:documentation><![CDATA[Consorsi senza personalità giuridica]]></xs:documentation>
  </xs:annotation>
</xs:enumeration>
<xs:enumeration value="12">
  <xs:annotation>
    <xs:documentation><![CDATA[Associazioni non riconosciute e comitati]]></xs:documentation>
  </xs:annotation>
</xs:enumeration>
<xs:enumeration value="13">
  <xs:annotation>
    <xs:documentation><![CDATA[Altre organizzazioni di persone o beni senza personalità giuridica, escluse le comunioni]]></xs:documentation>
  </xs:annotation>
</xs:enumeration>
<xs:enumeration value="14">
  <xs:annotation>
    <xs:documentation><![CDATA[Enti pubblici economici]]></xs:documentation>
  </xs:annotation>
</xs:enumeration>
<xs:enumeration value="15">
  <xs:annotation>
    <xs:documentation><![CDATA[Enti pubblici non economici]]></xs:documentation>
  </xs:annotation>
</xs:enumeration>
<xs:enumeration value="16">
  <xs:annotation>
    <xs:documentation><![CDATA[Casse mutue e fondi previdenza, assistenza, pensioni o simili con o senza personalità giuridica]]></xs:documentation>
  </xs:annotation>
</xs:enumeration>
<xs:enumeration value="17">
  <xs:annotation>
    <xs:documentation><![CDATA[Opere pie e società di mutuo soccorso]]></xs:documentation>
  </xs:annotation>
</xs:enumeration>
<xs:enumeration value="18">
  <xs:annotation>
    <xs:documentation><![CDATA[Enti ospedalieri]]></xs:documentation>
  </xs:annotation>
</xs:enumeration>
<xs:enumeration value="19">
  <xs:annotation>
    <xs:documentation><![CDATA[Enti ed istituti di previdenza e di assistenza sociale]]></xs:documentation>
  </xs:annotation>
</xs:enumeration>
```

```

</xs:annotation>
</xs:enumeration>
<xs:enumeration value="20">
  <xs:annotation>
    <xs:documentation><![CDATA[Aziende autonome di cura, soggiorno e turismo]]></xs:documentation>
  </xs:annotation>
</xs:enumeration>
<xs:enumeration value="21">
  <xs:annotation>
    <xs:documentation><![CDATA[Aziende regionali, provinciali, comunali e loro consorzi]]></xs:documentation>
  </xs:annotation>
</xs:enumeration>
<xs:enumeration value="22">
  <xs:annotation>
    <xs:documentation><![CDATA[Società, organizzazioni ed enti costituiti all'estero non altrimenti classificabili con sede
dell'amministrazione od oggetto principale in Italia]]></xs:documentation>
  </xs:annotation>
</xs:enumeration>
<xs:enumeration value="23">
  <xs:annotation>
    <xs:documentation><![CDATA[Società semplici ed equiparate, art.5, comma 3 lett.b del Tuir]]></xs:documentation>
  </xs:annotation>
</xs:enumeration>
<xs:enumeration value="24">
  <xs:annotation>
    <xs:documentation><![CDATA[Società in nome collettivo ed equiparate ai sensi dell'art. 5, comma 3, lett. b, del
TUIR]]></xs:documentation>
  </xs:annotation>
</xs:enumeration>
<xs:enumeration value="25">
  <xs:annotation>
    <xs:documentation><![CDATA[Società in accomandita semplice]]></xs:documentation>
  </xs:annotation>
</xs:enumeration>
<xs:enumeration value="26">
  <xs:annotation>
    <xs:documentation><![CDATA[Società di armamento]]></xs:documentation>
  </xs:annotation>
</xs:enumeration>
<xs:enumeration value="27">
  <xs:annotation>
    <xs:documentation><![CDATA[Associazioni fra artisti e professionisti]]></xs:documentation>
  </xs:annotation>
</xs:enumeration>
<xs:enumeration value="28">
  <xs:annotation>
    <xs:documentation><![CDATA[Aziende coniugali]]></xs:documentation>
  </xs:annotation>
</xs:enumeration>
<xs:enumeration value="29">
  <xs:annotation>
    <xs:documentation><![CDATA[GEIE (Gruppi europei di interesse economico)]]></xs:documentation>
  </xs:annotation>
</xs:enumeration>
<xs:enumeration value="30">
  <xs:annotation>
    <xs:documentation><![CDATA[Soggetti non residenti - Società semplici, irregolari e di fatto]]></xs:documentation>
  </xs:annotation>
</xs:enumeration>
<xs:enumeration value="31">
  <xs:annotation>
    <xs:documentation><![CDATA[Soggetti non residenti - Società in nome collettivo]]></xs:documentation>
  </xs:annotation>
</xs:enumeration>
<xs:enumeration value="32">
  <xs:annotation>
    <xs:documentation><![CDATA[Soggetti non residenti - Società in accomandita semplice]]></xs:documentation>
  </xs:annotation>
</xs:enumeration>
<xs:enumeration value="33">

```

```

<xs:annotation>
  <xs:documentation><![CDATA[Soggetti non residenti - Società di armamento]]></xs:documentation>
</xs:annotation>
</xs:enumeration>
<xs:enumeration value="34">
  <xs:annotation>
    <xs:documentation><![CDATA[Soggetti non residenti - Associazioni fra professionisti]]></xs:documentation>
  </xs:annotation>
</xs:enumeration>
<xs:enumeration value="35">
  <xs:annotation>
    <xs:documentation><![CDATA[Soggetti non residenti - Società in accomandita per azioni]]></xs:documentation>
  </xs:annotation>
</xs:enumeration>
<xs:enumeration value="36">
  <xs:annotation>
    <xs:documentation><![CDATA[Soggetti non residenti - Società a responsabilità limitata]]></xs:documentation>
  </xs:annotation>
</xs:enumeration>
<xs:enumeration value="37">
  <xs:annotation>
    <xs:documentation><![CDATA[Soggetti non residenti - Società per azioni]]></xs:documentation>
  </xs:annotation>
</xs:enumeration>
<xs:enumeration value="38">
  <xs:annotation>
    <xs:documentation><![CDATA[Soggetti non residenti - Consorzi]]></xs:documentation>
  </xs:annotation>
</xs:enumeration>
<xs:enumeration value="39">
  <xs:annotation>
    <xs:documentation><![CDATA[Soggetti non residenti - Altri enti ed istituti]]></xs:documentation>
  </xs:annotation>
</xs:enumeration>
<xs:enumeration value="40">
  <xs:annotation>
    <xs:documentation><![CDATA[Soggetti non residenti - Associazioni riconosciute, non riconosciute e di fatto]]></xs:documentation>
  </xs:annotation>
</xs:enumeration>
<xs:enumeration value="41">
  <xs:annotation>
    <xs:documentation><![CDATA[Soggetti non residenti - Fondazioni]]></xs:documentation>
  </xs:annotation>
</xs:enumeration>
<xs:enumeration value="42">
  <xs:annotation>
    <xs:documentation><![CDATA[Soggetti non residenti - Opere pie e società di mutuo soccorso]]></xs:documentation>
  </xs:annotation>
</xs:enumeration>
<xs:enumeration value="43">
  <xs:annotation>
    <xs:documentation><![CDATA[Soggetti non residenti - Altre organizzazioni di persone e di beni]]></xs:documentation>
  </xs:annotation>
</xs:enumeration>
<xs:enumeration value="44">
  <xs:annotation>
    <xs:documentation><![CDATA[Soggetti non residenti - Trust]]></xs:documentation>
  </xs:annotation>
</xs:enumeration>
<xs:enumeration value="45">
  <xs:annotation>
    <xs:documentation><![CDATA[Soggetti non residenti - GEIE (Gruppi europei di interesse economico)]]></xs:documentation>
  </xs:annotation>
</xs:enumeration>
<xs:enumeration value="50">
  <xs:annotation>
    <xs:documentation><![CDATA[Società per azioni, aziende speciali e consorzi artt. 31, 113, 114, 115 e 116 del D.Lgs 18/8/2000 n.267]]></xs:documentation>
  </xs:annotation>
</xs:enumeration>

```

	<pre> <xs:annotation> <xs:documentation><![CDATA[Femmina]]></xs:documentation> </xs:annotation> </xs:enumeration> </xs:restriction> </xs:simpleType> </pre>
--	---

simpleType **Situazione_Type**

namespace	urn:www.agenziaentrate.gov.it:specificheTecniche:sco:common																		
type	restriction of DatoNP_Type																		
facets	<table border="1"> <thead> <tr> <th>Kind</th> <th>Value</th> </tr> </thead> <tbody> <tr> <td>pattern</td> <td>[1-9]{1}[0-9]*</td> </tr> <tr> <td>enumeration</td> <td>1</td> </tr> <tr> <td>enumeration</td> <td>2</td> </tr> <tr> <td>enumeration</td> <td>3</td> </tr> <tr> <td>enumeration</td> <td>4</td> </tr> <tr> <td>enumeration</td> <td>5</td> </tr> <tr> <td>enumeration</td> <td>6</td> </tr> <tr> <td>enumeration</td> <td>7</td> </tr> </tbody> </table>	Kind	Value	pattern	[1-9]{1}[0-9]*	enumeration	1	enumeration	2	enumeration	3	enumeration	4	enumeration	5	enumeration	6	enumeration	7
Kind	Value																		
pattern	[1-9]{1}[0-9]*																		
enumeration	1																		
enumeration	2																		
enumeration	3																		
enumeration	4																		
enumeration	5																		
enumeration	6																		
enumeration	7																		
source	<pre> <xs:simpleType name="Situazione_Type"> <xs:restriction base="cm:DatoNP_Type"> <xs:enumeration value="1"> <xs:annotation> <xs:documentation><![CDATA[Periodo di imposta che inizia dalla data di messa in liquidazione per cessazione di attività, per fallimento o per liquidazione coatta amministrativa]]></xs:documentation> </xs:annotation> </xs:enumeration> <xs:enumeration value="2"> <xs:annotation> <xs:documentation><![CDATA[Periodi di imposta successivi a quello di dichiarazione di fallimento o di messa in liquidazione]]></xs:documentation> </xs:annotation> </xs:enumeration> <xs:enumeration value="3"> <xs:annotation> <xs:documentation><![CDATA[Periodo d'imposta in cui ha avuto termine la liquidazione per cessazione di attività, per fallimento o per liquidazione coatta amministrativa]]></xs:documentation> </xs:annotation> </xs:enumeration> <xs:enumeration value="4"> <xs:annotation> <xs:documentation><![CDATA[Periodo di imposta in cui si è verificata l'estinzione del soggetto per fusione o incorporazione]]></xs:documentation> </xs:annotation> </xs:enumeration> <xs:enumeration value="5"> <xs:annotation> <xs:documentation><![CDATA[Periodo d'imposta in cui è avvenuta la trasformazione da società soggetta ad IRES in società non soggetta ad IRES o viceversa]]></xs:documentation> </xs:annotation> </xs:enumeration> <xs:enumeration value="6"> <xs:annotation> <xs:documentation><![CDATA[Periodo normale d'imposta e periodo compreso tra l'inizio del periodo d'imposta e la data di messa in liquidazione]]></xs:documentation> </xs:annotation> </xs:enumeration> <xs:enumeration value="7"> <xs:annotation> <xs:documentation><![CDATA[Periodo d'imposta in cui si è verificata l'estinzione del soggetto per scissione totale]]></xs:documentation> </xs:annotation> </xs:enumeration> </xs:restriction> </xs:simpleType> </pre>																		

simpleType **Stato_Type**

namespace	urn:www.agenziaentrate.gov.it:specificheTecniche:sco:common												
type	restriction of DatoNP_Type												
facets	<table border="1"> <thead> <tr> <th>Kind</th> <th>Value</th> </tr> </thead> <tbody> <tr> <td>pattern</td> <td>[1-9]{1}[0-9]*</td> </tr> <tr> <td>enumeration</td> <td>1</td> </tr> <tr> <td>enumeration</td> <td>2</td> </tr> <tr> <td>enumeration</td> <td>3</td> </tr> <tr> <td>enumeration</td> <td>4</td> </tr> </tbody> </table>	Kind	Value	pattern	[1-9]{1}[0-9]*	enumeration	1	enumeration	2	enumeration	3	enumeration	4
Kind	Value												
pattern	[1-9]{1}[0-9]*												
enumeration	1												
enumeration	2												
enumeration	3												
enumeration	4												
source	<pre> <xs:simpleType name="Stato_Type"> <xs:restriction base="cm:DatoNP_Type"> <xs:enumeration value="1"> <xs:annotation> <xs:documentation><![CDATA[Soggetto in normale attività]]></xs:documentation> </xs:annotation> </xs:enumeration> <xs:enumeration value="2"> <xs:annotation> <xs:documentation><![CDATA[Soggetto in liquidazione per cessazione di attività]]></xs:documentation> </xs:annotation> </xs:enumeration> <xs:enumeration value="3"> <xs:annotation> <xs:documentation><![CDATA[Soggetto in fallimento o in liquidazione coatta amministrativa]]></xs:documentation> </xs:annotation> </xs:enumeration> <xs:enumeration value="4"> <xs:annotation> <xs:documentation><![CDATA[Soggetto estinto]]></xs:documentation> </xs:annotation> </xs:enumeration> </xs:restriction> </xs:simpleType> </pre>												

simpleType **Eventi_Ecc_Type**

namespace	urn:www.agenziaentrate.gov.it:specificheTecniche:sco:common										
type	restriction of xs:string										
facets	<table border="1"> <thead> <tr> <th>Kind</th> <th>Value</th> </tr> </thead> <tbody> <tr> <td>enumeration</td> <td>1</td> </tr> <tr> <td>enumeration</td> <td>2</td> </tr> <tr> <td>enumeration</td> <td>3</td> </tr> <tr> <td>enumeration</td> <td>4</td> </tr> </tbody> </table>	Kind	Value	enumeration	1	enumeration	2	enumeration	3	enumeration	4
Kind	Value										
enumeration	1										
enumeration	2										
enumeration	3										
enumeration	4										
source	<pre> <xs:simpleType name="Eventi_Ecc_Type"> <xs:restriction base="xs:string"> <xs:enumeration value="1"> <xs:annotation> <xs:documentation><![CDATA[Vittime di richieste estorsive e dell'usura]]></xs:documentation> </xs:annotation> </xs:enumeration> <xs:enumeration value="2"> <xs:annotation> <xs:documentation><![CDATA[Soggetti colpiti dagli eventi meteorologici del novembre 2013, verificatisi nella regione Sardegna]]></xs:documentation> </xs:annotation> </xs:enumeration> <xs:enumeration value="3"> <xs:annotation> <xs:documentation><![CDATA[Soggetti interessati dall'emergenza umanitaria legata all'afflusso di migranti dal Nord Africa]]></xs:documentation> </xs:annotation> </xs:enumeration> <xs:enumeration value="4"> <xs:annotation> </pre>										

	<pre> <xs:documentation><![CDATA[Soggetti colpiti da altri eventi eccezionali]]></xs:documentation> </xs:annotation> </xs:enumeration> </xs:restriction> </xs:simpleType> </pre>
--	--

simpleType **Estero**

namespace	urn:www.agenziaentrate.gov.it:specificheTecniche:common				
type	restriction of xs:string				
facets	<table border="1"> <thead> <tr> <th>Kind</th> <th>Value</th> </tr> </thead> <tbody> <tr> <td>enumeration</td> <td>EE</td> </tr> </tbody> </table>	Kind	Value	enumeration	EE
Kind	Value				
enumeration	EE				
source	<pre> <xs:simpleType name="Estero"> <xs:restriction base="xs:string"> <xs:enumeration value="EE"/> </xs:restriction> </xs:simpleType> </pre>				

simpleType **PE_Type**

namespace	urn:www.agenziaentrate.gov.it:specificheTecniche:common
type	union of (ProvinciItaliane , Estero)
source	<pre> <xs:simpleType name="PE_Type"> <xs:annotation> <xs:documentation>Tipo semplice costituito dalle sigle delle provincie italiane in vigore e dalla sigla "EE" che indica un paese estero.</xs:documentation> </xs:annotation> <xs:union memberTypes="ProvinciItaliane Estero"/> </xs:simpleType> </pre>

simpleType **PN_Type**

namespace	urn:www.agenziaentrate.gov.it:specificheTecniche:common
type	union of (ProvinciItaliane , ProvincieCroate , Estero)
source	<pre> <xs:simpleType name="PN_Type"> <xs:annotation> <xs:documentation>Tipo semplice costituito dalle sigle delle provincie italiane in vigore, dalle sigle delle provincie croate di Fiume, Pola e Zara e dalla sigla "EE" che indica un paese estero.</xs:documentation> </xs:annotation> <xs:union memberTypes="ProvinciItaliane ProvincieCroate Estero"/> </xs:simpleType> </pre>

simpleType **PR_Type**

namespace	urn:www.agenziaentrate.gov.it:specificheTecniche:common
type	union of (ProvinciItaliane)
source	<pre> <xs:simpleType name="PR_Type"> <xs:annotation> <xs:documentation>Tipo semplice costituito dalle sigle delle provincie italiane in vigore.</xs:documentation> </xs:annotation> <xs:union memberTypes="ProvinciItaliane"/> </xs:simpleType> </pre>

simpleType **ProvincieCroate**

namespace	urn:www.agenziaentrate.gov.it:specificheTecniche:common
type	restriction of xs:string

facets	<table> <thead> <tr> <th>Kind</th> <th>Value</th> </tr> </thead> <tbody> <tr> <td>enumeration</td> <td>FU</td> </tr> <tr> <td>enumeration</td> <td>PL</td> </tr> <tr> <td>enumeration</td> <td>ZA</td> </tr> </tbody> </table>	Kind	Value	enumeration	FU	enumeration	PL	enumeration	ZA
Kind	Value								
enumeration	FU								
enumeration	PL								
enumeration	ZA								
source	<pre> <xs:simpleType name="ProvinciaCroate"> <xs:restriction base="xs:string"> <xs:enumeration value="FU"> <xs:annotation> <xs:documentation>Fiume</xs:documentation> </xs:annotation> </xs:enumeration> <xs:enumeration value="PL"> <xs:annotation> <xs:documentation>Pola</xs:documentation> </xs:annotation> </xs:enumeration> <xs:enumeration value="ZA"> <xs:annotation> <xs:documentation>Zara</xs:documentation> </xs:annotation> </xs:enumeration> </xs:restriction> </xs:simpleType> </pre>								

simpleType **Provincieltaliane**

namespace	urn:www.agenziaentrate.gov.it:specificheTecniche:common																																																																														
type	restriction of xs:string																																																																														
facets	<table> <thead> <tr> <th>Kind</th> <th>Value</th> </tr> </thead> <tbody> <tr><td>enumeration</td><td>AG</td></tr> <tr><td>enumeration</td><td>AL</td></tr> <tr><td>enumeration</td><td>AN</td></tr> <tr><td>enumeration</td><td>AO</td></tr> <tr><td>enumeration</td><td>AP</td></tr> <tr><td>enumeration</td><td>AQ</td></tr> <tr><td>enumeration</td><td>AR</td></tr> <tr><td>enumeration</td><td>AT</td></tr> <tr><td>enumeration</td><td>AV</td></tr> <tr><td>enumeration</td><td>BA</td></tr> <tr><td>enumeration</td><td>BG</td></tr> <tr><td>enumeration</td><td>BI</td></tr> <tr><td>enumeration</td><td>BL</td></tr> <tr><td>enumeration</td><td>BN</td></tr> <tr><td>enumeration</td><td>BO</td></tr> <tr><td>enumeration</td><td>BR</td></tr> <tr><td>enumeration</td><td>BS</td></tr> <tr><td>enumeration</td><td>BT</td></tr> <tr><td>enumeration</td><td>BZ</td></tr> <tr><td>enumeration</td><td>CA</td></tr> <tr><td>enumeration</td><td>CB</td></tr> <tr><td>enumeration</td><td>CE</td></tr> <tr><td>enumeration</td><td>CH</td></tr> <tr><td>enumeration</td><td>CI</td></tr> <tr><td>enumeration</td><td>CL</td></tr> <tr><td>enumeration</td><td>CN</td></tr> <tr><td>enumeration</td><td>CO</td></tr> <tr><td>enumeration</td><td>CR</td></tr> <tr><td>enumeration</td><td>CS</td></tr> <tr><td>enumeration</td><td>CT</td></tr> <tr><td>enumeration</td><td>CZ</td></tr> <tr><td>enumeration</td><td>EN</td></tr> <tr><td>enumeration</td><td>FC</td></tr> <tr><td>enumeration</td><td>FE</td></tr> <tr><td>enumeration</td><td>FG</td></tr> <tr><td>enumeration</td><td>FI</td></tr> <tr><td>enumeration</td><td>FM</td></tr> <tr><td>enumeration</td><td>FR</td></tr> </tbody> </table>	Kind	Value	enumeration	AG	enumeration	AL	enumeration	AN	enumeration	AO	enumeration	AP	enumeration	AQ	enumeration	AR	enumeration	AT	enumeration	AV	enumeration	BA	enumeration	BG	enumeration	BI	enumeration	BL	enumeration	BN	enumeration	BO	enumeration	BR	enumeration	BS	enumeration	BT	enumeration	BZ	enumeration	CA	enumeration	CB	enumeration	CE	enumeration	CH	enumeration	CI	enumeration	CL	enumeration	CN	enumeration	CO	enumeration	CR	enumeration	CS	enumeration	CT	enumeration	CZ	enumeration	EN	enumeration	FC	enumeration	FE	enumeration	FG	enumeration	FI	enumeration	FM	enumeration	FR
Kind	Value																																																																														
enumeration	AG																																																																														
enumeration	AL																																																																														
enumeration	AN																																																																														
enumeration	AO																																																																														
enumeration	AP																																																																														
enumeration	AQ																																																																														
enumeration	AR																																																																														
enumeration	AT																																																																														
enumeration	AV																																																																														
enumeration	BA																																																																														
enumeration	BG																																																																														
enumeration	BI																																																																														
enumeration	BL																																																																														
enumeration	BN																																																																														
enumeration	BO																																																																														
enumeration	BR																																																																														
enumeration	BS																																																																														
enumeration	BT																																																																														
enumeration	BZ																																																																														
enumeration	CA																																																																														
enumeration	CB																																																																														
enumeration	CE																																																																														
enumeration	CH																																																																														
enumeration	CI																																																																														
enumeration	CL																																																																														
enumeration	CN																																																																														
enumeration	CO																																																																														
enumeration	CR																																																																														
enumeration	CS																																																																														
enumeration	CT																																																																														
enumeration	CZ																																																																														
enumeration	EN																																																																														
enumeration	FC																																																																														
enumeration	FE																																																																														
enumeration	FG																																																																														
enumeration	FI																																																																														
enumeration	FM																																																																														
enumeration	FR																																																																														

enumeration	GE
enumeration	GO
enumeration	GR
enumeration	IM
enumeration	IS
enumeration	KR
enumeration	LC
enumeration	LE
enumeration	LI
enumeration	LO
enumeration	LT
enumeration	LU
enumeration	MB
enumeration	MC
enumeration	ME
enumeration	MI
enumeration	MN
enumeration	MO
enumeration	MS
enumeration	MT
enumeration	NA
enumeration	NO
enumeration	NU
enumeration	OG
enumeration	OR
enumeration	OT
enumeration	PA
enumeration	PC
enumeration	PD
enumeration	PE
enumeration	PG
enumeration	PI
enumeration	PN
enumeration	PO
enumeration	PR
enumeration	PT
enumeration	PU
enumeration	PV
enumeration	PZ
enumeration	RA
enumeration	RC
enumeration	RE
enumeration	RG
enumeration	RI
enumeration	RM
enumeration	RN
enumeration	RO
enumeration	SA
enumeration	SI
enumeration	SO
enumeration	SP
enumeration	SR
enumeration	SS
enumeration	SV
enumeration	TA
enumeration	TE
enumeration	TN
enumeration	TO
enumeration	TP
enumeration	TR
enumeration	TS
enumeration	TV
enumeration	UD
enumeration	VA
enumeration	VB
enumeration	VC
enumeration	VE
enumeration	VI
enumeration	VR
enumeration	VS

	enumeration VT enumeration VV
source	<pre><xs:simpleType name="ProvincieItaliane"> <xs:annotation> <xs:documentation> Elenco delle provincie italiane in vigore, valori ammessi: Agrigento AG Alessandria AL Ancona AN Aosta AO Ascoli Piceno AP L'Aquila AQ Arezzo AR Asti AT Avellino AV Bari BA Bergamo BG Biella BI Belluno BL Benevento BN Bologna BO Brindisi BR Brescia BS Barletta-Andria-Trani BT Bolzano BZ Cagliari CA Campobasso CB Caserta CE Chieti CH Carbonia-Iglesias CI Caltanissetta CL Cuneo CN Como CO Cremona CR Cosenza CS Catania CT Catanzaro CZ Enna EN Forli-Cesena FC Ferrara FE Foggia FG Firenze FI Fermo FM Frosinone FR Genova GE Gorizia GO Grosseto GR Imperia IM Isernia IS Crotona KR Lecco LC Lecce LE Livorno LI Lodi LO Latina LT Lucca LU Monza e Brianza MB Macerata MC Messina ME Milano MI Mantova MN Modena MO Massa e Carrara MS Matera MT Napoli NA Novara NO Nuoro NU Ogliastra OG</pre>

	Oristano	OR	
	Olbia-Tempio	OT	
	Palermo		PA
	Piacenza	PC	
	Padova		PD
	Pescara		PE
	Perugia		PG
	Pisa		PI
	Pordenone		PN
	Prato		PO
	Parma		PR
	Pistoia		PT
	Pesaro e Urbino	PU	
	Pavia		PV
	Potenza		PZ
	Ravenna		RA
	Reggio Calabria	RC	
	Reggio Emilia	RE	
	Ragusa		RG
	Rieti		RI
	Roma		RM
	Rimini		RN
	Rovigo		RO
	Salerno		SA
	iena		SI
	Sondrio		SO
	La Spezia	SP	
	Siracusa	SR	
	Sassari		SS
	Savona		SV
	Taranto		TA
	Teramo		TE
	Trento		TN
	Torino		TO
	Trapani		TP
	Terni		TR
	Trieste		TS
	Treviso		TV
	Udine		UD
	Varese		VA
	Verbano-Cusio-Ossola	VB	
	Vercelli	VC	
	Venezia		VE
	Vicenza		VI
	Verona		VR
	Medio Campidano	VS	
	Viterbo		VT
	Vibo Valentia	VV	
	<code></xs:documentation></code>		
	<code></xs:annotation></code>		
	<code><xs:restriction base="xs:string"></code>		
	<code><xs:enumeration value="AG"/></code>		
	<code><xs:enumeration value="AL"/></code>		
	<code><xs:enumeration value="AN"/></code>		
	<code><xs:enumeration value="AO"/></code>		
	<code><xs:enumeration value="AP"/></code>		
	<code><xs:enumeration value="AQ"/></code>		
	<code><xs:enumeration value="AR"/></code>		
	<code><xs:enumeration value="AT"/></code>		
	<code><xs:enumeration value="AV"/></code>		
	<code><xs:enumeration value="BA"/></code>		
	<code><xs:enumeration value="BG"/></code>		
	<code><xs:enumeration value="BI"/></code>		
	<code><xs:enumeration value="BL"/></code>		
	<code><xs:enumeration value="BN"/></code>		
	<code><xs:enumeration value="BO"/></code>		
	<code><xs:enumeration value="BR"/></code>		
	<code><xs:enumeration value="BS"/></code>		
	<code><xs:enumeration value="BT"/></code>		

	<pre> <xs:enumeration value="SP"/> <xs:enumeration value="SR"/> <xs:enumeration value="SS"/> <xs:enumeration value="SV"/> <xs:enumeration value="TA"/> <xs:enumeration value="TE"/> <xs:enumeration value="TN"/> <xs:enumeration value="TO"/> <xs:enumeration value="TP"/> <xs:enumeration value="TR"/> <xs:enumeration value="TS"/> <xs:enumeration value="TV"/> <xs:enumeration value="UD"/> <xs:enumeration value="VA"/> <xs:enumeration value="VB"/> <xs:enumeration value="VC"/> <xs:enumeration value="VE"/> <xs:enumeration value="VI"/> <xs:enumeration value="VR"/> <xs:enumeration value="VS"/> <xs:enumeration value="VT"/> <xs:enumeration value="VV"/> </xs:restriction> </xs:simpleType> </pre>
--	---

complexType **DatiAnagraficiScelte_Type**

diagram	
namespace	urn:www.agenziaentrate.gov.it:specificheTecniche:sco:sce
children	sce:Cognome sce:Nome sce:Sesso sce:DataNascita sce:ComuneNascita sce:ProvinciaNascita
source	<pre> <xs:complexType name="DatiAnagraficiScelte_Type"> <xs:sequence> <xs:element name="Cognome" type="cm:DatoAN_Type" minOccurs="0"/> <xs:element name="Nome" type="cm:DatoAN_Type" minOccurs="0"/> <xs:element name="Sesso" type="sc:Sesso_Type" minOccurs="0"/> <xs:element name="DataNascita" type="cm:DatoDT_Type" minOccurs="0"/> <xs:element name="ComuneNascita" type="cm:DatoAN_Type" minOccurs="0"/> <xs:element name="ProvinciaNascita" type="cm:PN_Type" minOccurs="0"/> </xs:sequence> </xs:complexType> </pre>

element **DatiAnagraficiScelte_Type/Cognome**

diagram	
namespace	urn:www.agenziaentrate.gov.it:specificheTecniche:sco:sce
type	DatoAN_Type

facets	Kind Value pattern ([0-9A-Z-] \"){1}([0-9A-Z&] " - \., / "^\(\\) À É È Ì Ò Ù Û " \\ / +)*
source	<xs:element name="Cognome" type="cm:DatoAN_Type" minOccurs="0"/>

element **DatiAnagraficiScelte_Type/Nome**

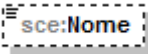
diagram	
namespace	urn:www.agenziaentrate.gov.it:specificheTecniche:sco:sce
type	DatoAN_Type
facets	Kind Value pattern ([0-9A-Z-] \"){1}([0-9A-Z&] " - \., / "^\(\\) À É È Ì Ò Ù Û " \\ / +)*
source	<xs:element name="Nome" type="cm:DatoAN_Type" minOccurs="0"/>

element **DatiAnagraficiScelte_Type/Sesso**

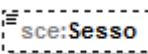
diagram	
namespace	urn:www.agenziaentrate.gov.it:specificheTecniche:sco:sce
type	Sesso_Type
facets	Kind Value pattern ([0-9A-Z-] \"){1}([0-9A-Z&] " - \., / "^\(\\) À É È Ì Ò Ù Û " \\ / +)* enumeration M enumeration F
source	<xs:element name="Sesso" type="sc:Sesso_Type" minOccurs="0"/>

element **DatiAnagraficiScelte_Type/DataNascita**

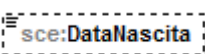
diagram	
namespace	urn:www.agenziaentrate.gov.it:specificheTecniche:sco:sce
type	DatoDT_Type
facets	Kind Value pattern ((([0-1-9][12][0-9][301])(0[13578][10]12)\d{4})) ((([0][1-9][12][0-9][30](0[469][11]\d{4})) ((0[1-9][10-9][20-8])[02]\d{4})) ((29)(02)[02468][048]00)) ((29)(02)[13579][26]00)) ((29)(02)[0-9][0][048]) ((29)(02)[0-9][0-9][2468][048]) ((29)(02)[0-9][0-9][13579][26]))
source	<xs:element name="DataNascita" type="cm:DatoDT_Type" minOccurs="0"/>

element **DatiAnagraficiScelte_Type/ComuneNascita**

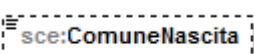
diagram	
namespace	urn:www.agenziaentrate.gov.it:specificheTecniche:sco:sce
type	DatoAN_Type
facets	Kind Value pattern ([0-9A-Z-] \"){1}([0-9A-Z&] " - \., / "^\(\\) À É È Ì Ò Ù Û " \\ / +)*
source	<xs:element name="ComuneNascita" type="cm:DatoAN_Type" minOccurs="0"/>

element **DatiAnagraficiScelte_Type/ProvinciaNascita**

diagram	
namespace	urn:www.agenziaentrate.gov.it:specificheTecniche:sco:sce
type	PN_Type
source	<code><xs:element name="ProvinciaNascita" type="cm:PN_Type" minOccurs="0"/></code>

complexType **Documento_Type**

diagram					
namespace	urn:www.agenziaentrate.gov.it:specificheTecniche:sco:sce				
type	extension of Documento_Type				
children	sce:BustaVuota sce:CfBusta				
attributes	Name	Type	Use	Default	Fixed
	identificativo	Identificativo_Type	required		
source	<pre> <xs:complexType name="Documento_Type"> <xs:complexContent> <xs:extension base="cm:Documento_Type"> <xs:sequence> <xs:element name="BustaVuota" type="cm:DatoCB_Type" minOccurs="0"/> <xs:element name="CfBusta" type="cm:DatoAN_Type" minOccurs="0"/> </xs:sequence> </xs:extension> </xs:complexContent> </xs:complexType> </pre>				

element **Documento_Type/BustaVuota**

diagram	
namespace	urn:www.agenziaentrate.gov.it:specificheTecniche:sco:sce
type	DatoCB_Type
facets	Kind Value pattern [01]
source	<code><xs:element name="BustaVuota" type="cm:DatoCB_Type" minOccurs="0"/></code>

element **Documento_Type/CfBusta**

diagram	
---------	--

namespace	urn:www.agenziaentrate.gov.it:specificheTecniche:sco:sce
type	DatoAN_Type
facets	Kind Value pattern ([0-9A-Z-~] \"){1}([0-9A-Z&:] [-\ . / °\^\(\)\ À É È Ì Ò Ù Ú Û " \ \\ \ +)*
source	<xs:element name="CfBusta" type="cm:DatoAN_Type" minOccurs="0"/>

Schema forniture734_2015_v1.xsd

schema location: **forniture734_2015_v1.xsd**
 attribute form default: **unqualified**
 element form default: **qualified**
 targetNamespace: **urn:www.agenziaentrate.gov.it:specificheTecniche:sco:730**

Elements Fornitura730-4

element Fornitura730-4

diagram	
namespace	urn:www.agenziaentrate.gov.it:specificheTecniche:sco:730
children	m730:Instestazione m730:Documento_730-4
source	<pre> <xs:element name="Fornitura730-4"> <xs:complexType> <xs:sequence> <xs:element name="Instestazione"> <xs:complexType> <xs:sequence> <xs:element name="CodiceFornitura" type="cm:DatoAN_Type" fixed="M7315"/> <xs:element name="TipoFornitore" type="cm:DatoNP_Type" fixed="13"/> <xs:element name="TotaleDocumenti" type="cm:DatoNP_Type" minOccurs="0"/> </xs:sequence> </xs:complexType> </xs:element> <xs:element name="Documento_730-4" type="m730:Documento_730-4" maxOccurs="unbounded"/> </xs:sequence> </xs:complexType> </xs:element> </pre>

element Fornitura730-4/Instestazione

diagram	
namespace	urn:www.agenziaentrate.gov.it:specificheTecniche:sco:730
children	m730:CodiceFornitura m730:TipoFornitore m730:TotaleDocumenti

source	<pre> <xs:element name="Intestazione"> <xs:complexType> <xs:sequence> <xs:element name="CodiceFornitura" type="cm:DatoAN_Type" fixed="M7315"/> <xs:element name="TipoFornitore" type="cm:DatoNP_Type" fixed="13"/> <xs:element name="TotaleDocumenti" type="cm:DatoNP_Type" minOccurs="0"/> </xs:sequence> </xs:complexType> </xs:element> </pre>
--------	---

element Fornitura730-4/Intestazione/CodiceFornitura

diagram					
namespace	urn:www.agenziaentrate.gov.it:specificheTecniche:sco:730				
type	DatoAN_Type				
facets	<table border="1"> <tr> <th>Kind</th> <th>Value</th> </tr> <tr> <td>pattern</td> <td>(([0-9A-Z- &quot;]){1})([0-9A-Z&amp; ' -\. _ s / ° ^\(\) À É Ì Ò Ù Ü &quot; \ \+)*</td> </tr> </table>	Kind	Value	pattern	(([0-9A-Z- "]){1})([0-9A-Z& ' -\. _ s / ° ^\(\) À É Ì Ò Ù Ü " \ \+)*
Kind	Value				
pattern	(([0-9A-Z- "]){1})([0-9A-Z& ' -\. _ s / ° ^\(\) À É Ì Ò Ù Ü " \ \+)*				
source	<pre><xs:element name="CodiceFornitura" type="cm:DatoAN_Type" fixed="M7315"/></pre>				

element Fornitura730-4/Intestazione/TipoFornitore

diagram					
namespace	urn:www.agenziaentrate.gov.it:specificheTecniche:sco:730				
type	DatoNP_Type				
facets	<table border="1"> <tr> <th>Kind</th> <th>Value</th> </tr> <tr> <td>pattern</td> <td>[1-9]{1}[0-9]*</td> </tr> </table>	Kind	Value	pattern	[1-9]{1}[0-9]*
Kind	Value				
pattern	[1-9]{1}[0-9]*				
source	<pre><xs:element name="TipoFornitore" type="cm:DatoNP_Type" fixed="13"/></pre>				

element Fornitura730-4/Intestazione/TotaleDocumenti

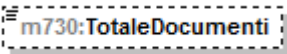
diagram					
namespace	urn:www.agenziaentrate.gov.it:specificheTecniche:sco:730				
type	DatoNP_Type				
facets	<table border="1"> <tr> <th>Kind</th> <th>Value</th> </tr> <tr> <td>pattern</td> <td>[1-9]{1}[0-9]*</td> </tr> </table>	Kind	Value	pattern	[1-9]{1}[0-9]*
Kind	Value				
pattern	[1-9]{1}[0-9]*				
source	<pre><xs:element name="TotaleDocumenti" type="cm:DatoNP_Type" minOccurs="0"/></pre>				

element **Fornitura730-4/Documento_730-4**

<p>diagram</p>	
<p>namespace</p>	<p>urn:www.agenziaentrate.gov.it:specificheTecniche:sco:730</p>
<p>type</p>	<p>m730:Documento_730-4</p>
<p>children</p>	<p>m730:DatiAnagraficiDichiarante m730:Sostituto m730:SoggettoAssFiscale730-4 m730:AltriDati m730:DatiContabili730-4</p>
<p>source</p>	<p><code><xs:element name="Documento_730-4" type="m730:Documento_730-4" maxOccurs="unbounded"/></code></p>