

ALLEGATO B

**Specifiche tecniche per la fornitura
delle Dichiarazioni Precompilate**

Schema **fornituraP73_2015_v1.xsd**

schema location: [fornituraP73_2015_v1.xsd](#)
attribute form default: **unqualified**
element form default: **qualified**
targetNamespace: **urn:www.agenziaentrate.gov.it:specificheTecniche:sco:730**

Elements Complex types
Fornitura [Esito Richiesta Type](#)
 [Intestazione P73 Type](#)

schema location: [documentoP73_2015_v1.xsd](#)
attribute form default: **unqualified**
element form default: **qualified**
targetNamespace: **urn:www.agenziaentrate.gov.it:specificheTecniche:sco:730**

Complex types
[Acconti Altri Dati Type](#)
[Acconti Irpef Anno Imposta Type](#)
[Acconti Ritenute Type](#)
[Acquisto Costruzione Abit Locazione](#)
[Addizionali Type](#)
[Altre Detrazioni Type](#)
[Altre Ritenute Type](#)
[Altre Spese Type](#)
[Altri Dati Type](#)
[Altri Oneri Type](#)
[Altri Redditi Ass Lavd Type](#)
[Altri Redditi Diversi Detr Type](#)
[Altri Redditi Diversi Type](#)
[Altri Redditi Lavoro Autonomo Type](#)
[Altri Redditi Type](#)
[Altri Redditi Utili Type](#)
[Assegno Coniuge Type](#)
[Bonus Irpef Type](#)
[Casella Acconto Type](#)
[Cedolare Secca Type](#)
[Contributi Previdenza Complementare Type](#)
[Contributo Solidarieta Type](#)
[Cred Imp Estero Type](#)
[Crediti F24 Type](#)
[Crediti Imposta](#)
[Crediti Imposta Altri Sisma Abruzzo Type](#)
[Crediti Imposta Fabbicati Type](#)
[Crediti Imposta Fondi Pensione Type](#)
[Crediti Imposta Redditi Esteri Type](#)
[Credito Immobile Sisma Abruzzo Type](#)
[Credito Stato Type](#)
[Credito Type](#)
[Dati 730Integrativo Type](#)
[Dati Altre Detrazioni Modulo Type](#)
[Dati Altre Detrazioni Type](#)
[Dati Catastali Recupero Patrimonio Edilizio Type](#)
[Dati Coniuge Type](#)
[Dati Contabili Type](#)
[Dati Contratto Type](#)
[Dati Familiare Type](#)
[Dati Nascita PF Type](#)
[Dati Primo Figlio Type](#)

[Dati Registrazione Accatastamento Recupero Patrimonio Edilizio Type](#)
[Debito Type](#)
[Deduzioni Modulo Type](#)
[Deduzioni Type](#)
[Detrazione Crediti Type](#)
[Detrazioni Canoni Locazione Type](#)
[Detrazioni Modulo Type](#)
[Detrazioni Type](#)
[Documento P73 Type](#)
[Domicilio Fiscale type](#)
[Eccedenze Type](#)
[Elemento Integrativo Type](#)
[Esenzione Add Comunale Type](#)
[Esito Liquidazione Type](#)
[FabbricatoAgev Type](#)
[FabbricatoOrd Type](#)
[Familiari PrimoModulo Type](#)
[Familiari Type](#)
[Fondo Pensione Dipendenti Pubblici Type](#)
[Frontespizio 730 Type](#)
[Giorni Percentuale Type](#)
[Imposta Lorda Type](#)
[Imposta Netta Type](#)
[Imposte Rimborsate Type](#)
[Incremento Produttivita Type](#)
[Inquilini Abitazione Principale Type](#)
[Intervento Recupero Patrimonio Edilizio Type](#)
[Intervento Risparmio Energetico Type](#)
[Lavoro Dipendente Type](#)
[Misura Acconti Type](#)
[Modulo Altri Redditi Type](#)
[Modulo Crediti Imposta Type](#)
[Modulo Fabbricato Type](#)
[Modulo Familiari Type](#)
[Modulo Lavoro Dip Type](#)
[Modulo Oneri Type](#)
[Modulo PL Type](#)
[Modulo Terreno Type](#)
[N Rate Type](#)
[Oneri Non Abbattuti Type](#)
[Oneri Type](#)
[Opzione Produttivita Type](#)
[Periodo Di Lavoro Type](#)
[Primo Modulo Acconti Ritenute Type](#)
[Primo Modulo Crediti Imposta Type](#)
[Primo Modulo Lavoro Dip Type](#)
[Primo Modulo PL Type](#)
[PrimoModulo Oneri Type](#)
[Prospetto Liquidazione Type](#)
[Prospetto Type](#)
[Redditi Capitale Type](#)
[Redditi Eredi Legatari Type](#)
[Redditi Fabbricati Type](#)
[Redditi Lavoro Dip Type](#)
[Redditi Ritenute Spese Type](#)
[Redditi Ritenute Type](#)
[Redditi Tassazione Separata Type](#)
[Redditi Terreni Type](#)
[Reddito Erede Type](#)
[Residuo Credito Compens AnnoImposta Type](#)
[Residuo Credito Compens Type](#)
[Riepilogo Redditi Type](#)
[Ritenute Acconti Sospesi Type](#)
[Ritenute Lavoro Dip Type](#)
[Sezione Altri Redd Type](#)
[Sezione Dati Catastali Recupero Patrimonio Edilizio Type](#)
[Soggetto Fiscale 730 Type](#)
[Soglie Esenzione Type](#)
[Spese Arredo Type](#)

[Spese Rateizzate Anni Precedenti Type](#)
[Spese Rateizzate Type](#)
[Tassazione Separata Type](#)
[Terreno Type](#)

schema location: [sintetico730.xsd](#)
 attribute form default: **unqualified**
 element form default: **qualified**
 targetNamespace: **urn:www.agenziaentrate.gov.it:specificheTecniche:sco:730**

| | | |
|------------------------------|------------------------------------|-----------------------------|
| Elements | Complex types | Simple types |
| ElencoFonti | AnagraficaType | DataType |
| Sintetico730 | DatiAnagraficiType | ImportoType |
| | DettaglioFonteType | |
| | DettaglioType | |
| | ElencoFontiType | |
| | FonteType | |

element Fornitura

| | |
|-----------|--|
| diagram | |
| namespace | urn:www.agenziaentrate.gov.it:specificheTecniche:sco:730 |
| children | m730:Instestazione m730:EsitoRichiesta |

element Fornitura/Instestazione

| | |
|---------|--|
| diagram | |
|---------|--|

| | |
|-----------|---|
| namespace | urn:www.agenziaentrate.gov.it:specificheTecniche:sco:730 |
| type | m730:Intestazione_P73_Type |
| children | m730:CodiceFornitura m730:TotaleDocRichiesti m730:TotaleDocForniti m730:TotaleDocScartati m730:TotaleDocNonReperiti |

element **Fornitura/EsitoRichiesta**

| | |
|-----------|--|
| diagram | |
| namespace | urn:www.agenziaentrate.gov.it:specificheTecniche:sco:730 |
| type | m730:Esito_Richiesta_Type |
| children | m730:CodiceFiscaleRichiesta m730:AnagraficaContribuente m730:DocumentoP73 m730:Sintetico730 m730:Stato |

complexType **Esito_Richiesta_Type**

| | |
|-----------|--|
| diagram | |
| namespace | urn:www.agenziaentrate.gov.it:specificheTecniche:sco:730 |
| children | m730:CodiceFiscaleRichiesta m730:AnagraficaContribuente m730:DocumentoP73 m730:Sintetico730 m730:Stato |

element **Esito_Richiesta_Type/CodiceFiscaleRichiesta**

| | |
|-----------|--|
| diagram | |
| namespace | urn:www.agenziaentrate.gov.it:specificheTecniche:sco:730 |

element **Esito_Richiesta_Type/AnagraficaContribuente**

| | |
|-----------|---|
| diagram | |
| namespace | urn:www.agenziaentrate.gov.it:specificheTecniche:sco:730 |
| children | m730:CodiceFiscale m730:Cognome m730:Nome |

element **Esito_Richiesta_Type/AnagraficaContribuente/CodiceFiscale**

| | | | | | |
|-----------|---|------|-------|---------|--|
| diagram | | | | | |
| namespace | urn:www.agenziaentrate.gov.it:specificheTecniche:sco:730 | | | | |
| type | DatoCF_Type | | | | |
| facets | <table border="0"> <tr> <td>Kind</td> <td>Value</td> </tr> <tr> <td>pattern</td> <td>[0-9]{11}[A-Z]{6}[0-9LMNPQRSTUUV]{2}[A-Z]{1}[0-9LMNPQRSTUUV]{2}[A-Z]{1}[0-9LMNPQRSTUUV]{3}[A-Z]{1}</td> </tr> </table> | Kind | Value | pattern | [0-9]{11}[A-Z]{6}[0-9LMNPQRSTUUV]{2}[A-Z]{1}[0-9LMNPQRSTUUV]{2}[A-Z]{1}[0-9LMNPQRSTUUV]{3}[A-Z]{1} |
| Kind | Value | | | | |
| pattern | [0-9]{11}[A-Z]{6}[0-9LMNPQRSTUUV]{2}[A-Z]{1}[0-9LMNPQRSTUUV]{2}[A-Z]{1}[0-9LMNPQRSTUUV]{3}[A-Z]{1} | | | | |

element **Esito_Richiesta_Type/AnagraficaContribuente/Cognome**

| | | | | | |
|-----------|--|------|-------|---------|---|
| diagram | | | | | |
| namespace | urn:www.agenziaentrate.gov.it:specificheTecniche:sco:730 | | | | |
| type | DatoAN_Type | | | | |
| facets | <table border="0"> <tr> <td>Kind</td> <td>Value</td> </tr> <tr> <td>pattern</td> <td>(([0-9A-Z-] \&quot;){1}([0-9A-Z&amp;:] ' ^- _ . / ^*\(\ \) À É Ê Ë Ì Ò Ù Û Ü &quot; \ \\ / +)*</td> </tr> </table> | Kind | Value | pattern | (([0-9A-Z-] \"){1}([0-9A-Z&:] ' ^- _ . / ^*\(\ \) À É Ê Ë Ì Ò Ù Û Ü " \ \\ / +)* |
| Kind | Value | | | | |
| pattern | (([0-9A-Z-] \"){1}([0-9A-Z&:] ' ^- _ . / ^*\(\ \) À É Ê Ë Ì Ò Ù Û Ü " \ \\ / +)* | | | | |

element **Esito_Richiesta_Type/AnagraficaContribuente/Nome**

| | | | | | |
|-----------|--|------|-------|---------|---|
| diagram | | | | | |
| namespace | urn:www.agenziaentrate.gov.it:specificheTecniche:sco:730 | | | | |
| type | DatoAN_Type | | | | |
| facets | <table border="0"> <tr> <td>Kind</td> <td>Value</td> </tr> <tr> <td>pattern</td> <td>(([0-9A-Z-] \&quot;){1}([0-9A-Z&amp;:] ' ^- _ . / ^*\(\ \) À É Ê Ë Ì Ò Ù Û Ü &quot; \ \\ / +)*</td> </tr> </table> | Kind | Value | pattern | (([0-9A-Z-] \"){1}([0-9A-Z&:] ' ^- _ . / ^*\(\ \) À É Ê Ë Ì Ò Ù Û Ü " \ \\ / +)* |
| Kind | Value | | | | |
| pattern | (([0-9A-Z-] \"){1}([0-9A-Z&:] ' ^- _ . / ^*\(\ \) À É Ê Ë Ì Ò Ù Û Ü " \ \\ / +)* | | | | |

element **Esito_Richiesta_Type/DocumentoP73**

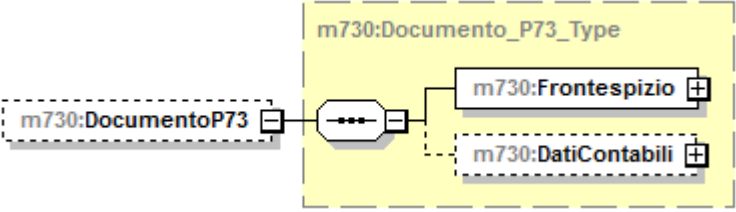
| | |
|-----------|--|
| diagram |  |
| namespace | urn:www.agenziaentrate.gov.it:specificheTecniche:sco:730 |
| type | m730:Documento_P73_Type |
| children | m730:Frontespizio m730:DatiContabili |

element **Esito_Richiesta_Type/Stato**

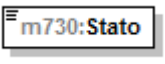
| | |
|-----------|---|
| diagram |  |
| namespace | urn:www.agenziaentrate.gov.it:specificheTecniche:sco:730 |
| type | DatoNP_Type |
| facets | Kind Value pattern [1-9]{1}[0-9]* |

complexType **Intestazione_P73_Type**

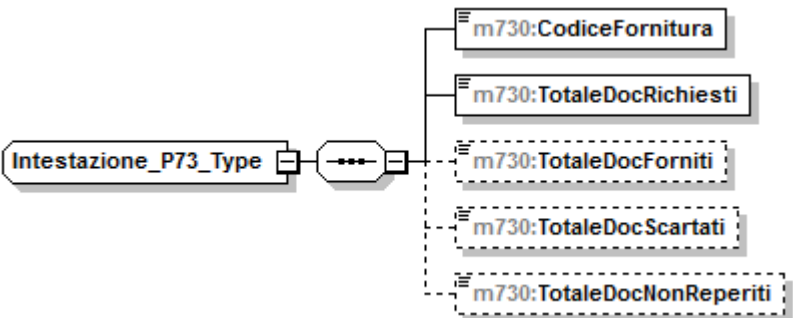
| | |
|-----------|---|
| diagram |  |
| namespace | urn:www.agenziaentrate.gov.it:specificheTecniche:sco:730 |
| children | m730:CodiceFornitura m730:TotaleDocRichiesti m730:TotaleDocForniti m730:TotaleDocScartati m730:TotaleDocNonReperiti |

element **Intestazione_P73_Type/CodiceFornitura**

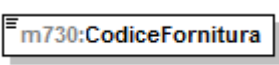
| | |
|-----------|--|
| diagram |  |
| namespace | urn:www.agenziaentrate.gov.it:specificheTecniche:sco:730 |
| type | restriction of DatoAN_Type |
| facets | Kind Value pattern (([0-9A-Z-] \"){1}([0-9A-Z&:; ' - \., / ° °\ (\)À È É Ì Ò Ù Û " \ \\ / +)* |

element **Intestazione_P73_Type/TotaleDocRichiesti**

| | |
|-----------|---|
| diagram |  m730:TotaleDocRichiesti |
| namespace | urn:www.agenziaentrate.gov.it:specificheTecniche:sco:730 |
| type | DatoNP_Type |
| facets | Kind Value pattern [1-9]{1}[0-9]* |

element **Intestazione_P73_Type/TotaleDocForniti**

| | |
|-----------|---|
| diagram |  m730:TotaleDocForniti |
| namespace | urn:www.agenziaentrate.gov.it:specificheTecniche:sco:730 |
| type | DatoNP_Type |
| facets | Kind Value pattern [1-9]{1}[0-9]* |

element **Intestazione_P73_Type/TotaleDocScartati**

| | |
|-----------|---|
| diagram |  m730:TotaleDocScartati |
| namespace | urn:www.agenziaentrate.gov.it:specificheTecniche:sco:730 |
| type | DatoNP_Type |
| facets | Kind Value pattern [1-9]{1}[0-9]* |

element **Intestazione_P73_Type/TotaleDocNonReperiti**

| | |
|-----------|---|
| diagram |  m730:TotaleDocNonReperiti |
| namespace | urn:www.agenziaentrate.gov.it:specificheTecniche:sco:730 |
| type | DatoNP_Type |
| facets | Kind Value pattern [1-9]{1}[0-9]* |

complexType **Acconti_Altri_Dati_Type**

| | |
|-----------|---|
| diagram | |
| namespace | urn:www.agenziaentrate.gov.it:specificheTecniche:sco:730 |
| children | m730:IncapientiDetrazioneFigli m730:IncapientiDetrazioneLocazione m730:RestituzioneBonusFiscale m730:RestituzioneBonusStraordinario m730:Pignoramento |

element **Acconti_Altri_Dati_Type/IncapientiDetrazioneFigli**

| | | | | | |
|-----------|---|------|-------|---------|----------------|
| diagram | | | | | |
| namespace | urn:www.agenziaentrate.gov.it:specificheTecniche:sco:730 | | | | |
| type | DatoNP_Type | | | | |
| facets | <table border="1"> <tr> <td>Kind</td> <td>Value</td> </tr> <tr> <td>pattern</td> <td>[1-9]{1}[0-9]*</td> </tr> </table> | Kind | Value | pattern | [1-9]{1}[0-9]* |
| Kind | Value | | | | |
| pattern | [1-9]{1}[0-9]* | | | | |

element **Acconti_Altri_Dati_Type/IncapientiDetrazioneLocazione**

| | | | | | |
|-----------|---|------|-------|---------|----------------|
| diagram | | | | | |
| namespace | urn:www.agenziaentrate.gov.it:specificheTecniche:sco:730 | | | | |
| type | DatoNP_Type | | | | |
| facets | <table border="1"> <tr> <td>Kind</td> <td>Value</td> </tr> <tr> <td>pattern</td> <td>[1-9]{1}[0-9]*</td> </tr> </table> | Kind | Value | pattern | [1-9]{1}[0-9]* |
| Kind | Value | | | | |
| pattern | [1-9]{1}[0-9]* | | | | |

element **Acconti_Altri_Dati_Type/RestituzioneBonusFiscale**

| | | | | | |
|-----------|---|------|-------|---------|----------------|
| diagram | | | | | |
| namespace | urn:www.agenziaentrate.gov.it:specificheTecniche:sco:730 | | | | |
| type | DatoNP_Type | | | | |
| facets | <table border="1"> <tr> <td>Kind</td> <td>Value</td> </tr> <tr> <td>pattern</td> <td>[1-9]{1}[0-9]*</td> </tr> </table> | Kind | Value | pattern | [1-9]{1}[0-9]* |
| Kind | Value | | | | |
| pattern | [1-9]{1}[0-9]* | | | | |

element Acconti_Altri_Dati_Type/RestituzioneBonusStraordinario

| diagram | | | | | |
|-----------|---|------|-------|---------|----------------|
| namespace | urn:www.agenziaentrate.gov.it:specificheTecniche:sco:730 | | | | |
| type | DatoNP_Type | | | | |
| facets | <table border="1"> <thead> <tr> <th>Kind</th> <th>Value</th> </tr> </thead> <tbody> <tr> <td>pattern</td> <td>[1-9]{1}[0-9]*</td> </tr> </tbody> </table> | Kind | Value | pattern | [1-9]{1}[0-9]* |
| Kind | Value | | | | |
| pattern | [1-9]{1}[0-9]* | | | | |

element Acconti_Altri_Dati_Type/Pignoramento

| | |
|-----------|--|
| diagram | |
| namespace | urn:www.agenziaentrate.gov.it:specificheTecniche:sco:730 |
| children | m730:TipoRedditoPignoramento m730:RitenutePignoramento |

element Acconti_Altri_Dati_Type/Pignoramento/TipoRedditoPignoramento

| diagram | | | | | | | | | | | | | | | | | |
|-------------|--|------|-------|---------|-------|-------------|---|-------------|---|-------------|---|-------------|---|-------------|---|-------------|---|
| namespace | urn:www.agenziaentrate.gov.it:specificheTecniche:sco:730 | | | | | | | | | | | | | | | | |
| type | restriction of DatoN1_Type | | | | | | | | | | | | | | | | |
| facets | <table border="1"> <thead> <tr> <th>Kind</th> <th>Value</th> </tr> </thead> <tbody> <tr> <td>pattern</td> <td>[1-9]</td> </tr> <tr> <td>enumeration</td> <td>1</td> </tr> <tr> <td>enumeration</td> <td>2</td> </tr> <tr> <td>enumeration</td> <td>3</td> </tr> <tr> <td>enumeration</td> <td>4</td> </tr> <tr> <td>enumeration</td> <td>5</td> </tr> <tr> <td>enumeration</td> <td>6</td> </tr> </tbody> </table> | Kind | Value | pattern | [1-9] | enumeration | 1 | enumeration | 2 | enumeration | 3 | enumeration | 4 | enumeration | 5 | enumeration | 6 |
| Kind | Value | | | | | | | | | | | | | | | | |
| pattern | [1-9] | | | | | | | | | | | | | | | | |
| enumeration | 1 | | | | | | | | | | | | | | | | |
| enumeration | 2 | | | | | | | | | | | | | | | | |
| enumeration | 3 | | | | | | | | | | | | | | | | |
| enumeration | 4 | | | | | | | | | | | | | | | | |
| enumeration | 5 | | | | | | | | | | | | | | | | |
| enumeration | 6 | | | | | | | | | | | | | | | | |

element Acconti_Altri_Dati_Type/Pignoramento/RitenutePignoramento

| diagram | | | | | |
|-----------|---|------|-------|---------|----------------|
| namespace | urn:www.agenziaentrate.gov.it:specificheTecniche:sco:730 | | | | |
| type | DatoNP_Type | | | | |
| facets | <table border="1"> <thead> <tr> <th>Kind</th> <th>Value</th> </tr> </thead> <tbody> <tr> <td>pattern</td> <td>[1-9]{1}[0-9]*</td> </tr> </tbody> </table> | Kind | Value | pattern | [1-9]{1}[0-9]* |
| Kind | Value | | | | |
| pattern | [1-9]{1}[0-9]* | | | | |

complexType **Acconti_Irpef_Anno_Imposta_Type**

| | |
|-----------|---|
| diagram | |
| namespace | urn:www.agenziaentrate.gov.it:specificheTecniche:sco:730 |
| children | m730:PrimaRataAccontolrpef m730:SecondaRataAccontolrpef m730:AccontoAddComunale m730:AccontoAddComunaleF24 m730:PrimaRataAccontoCedolare m730:SecondaRataAccontoCedo... |

element **Acconti_Irpef_Anno_Imposta_Type/PrimaRataAccontolrpef**

| | | | | | |
|-----------|---|------|-------|---------|----------------|
| diagram | | | | | |
| namespace | urn:www.agenziaentrate.gov.it:specificheTecniche:sco:730 | | | | |
| type | DatoNP_Type | | | | |
| facets | <table border="1"> <tr> <td>Kind</td> <td>Value</td> </tr> <tr> <td>pattern</td> <td>[1-9]{1}[0-9]*</td> </tr> </table> | Kind | Value | pattern | [1-9]{1}[0-9]* |
| Kind | Value | | | | |
| pattern | [1-9]{1}[0-9]* | | | | |

element **Acconti_Irpef_Anno_Imposta_Type/SecondaRataAccontolrpef**

| | | | | | |
|-----------|---|------|-------|---------|----------------|
| diagram | | | | | |
| namespace | urn:www.agenziaentrate.gov.it:specificheTecniche:sco:730 | | | | |
| type | DatoNP_Type | | | | |
| facets | <table border="1"> <tr> <td>Kind</td> <td>Value</td> </tr> <tr> <td>pattern</td> <td>[1-9]{1}[0-9]*</td> </tr> </table> | Kind | Value | pattern | [1-9]{1}[0-9]* |
| Kind | Value | | | | |
| pattern | [1-9]{1}[0-9]* | | | | |

element **Acconti_Irpef_Anno_Imposta_Type/AccontoAddComunale**

| | | | | | |
|-----------|---|------|-------|---------|----------------|
| diagram | | | | | |
| namespace | urn:www.agenziaentrate.gov.it:specificheTecniche:sco:730 | | | | |
| type | DatoNP_Type | | | | |
| facets | <table border="1"> <tr> <td>Kind</td> <td>Value</td> </tr> <tr> <td>pattern</td> <td>[1-9]{1}[0-9]*</td> </tr> </table> | Kind | Value | pattern | [1-9]{1}[0-9]* |
| Kind | Value | | | | |
| pattern | [1-9]{1}[0-9]* | | | | |

element **Acconti_Irpef_Anno_Imposta_Type/AccontoAddComunaleF24**

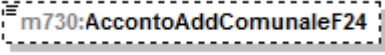
| | |
|-----------|---|
| diagram |  |
| namespace | urn:www.agenziaentrate.gov.it:specificheTecniche:sco:730 |
| type | DatoNP_Type |
| facets | Kind Value pattern [1-9]{1}[0-9]* |

element **Acconti_Irpef_Anno_Imposta_Type/PrimaRataAccontoCedolare**

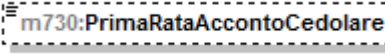
| | |
|-----------|---|
| diagram |  |
| namespace | urn:www.agenziaentrate.gov.it:specificheTecniche:sco:730 |
| type | DatoNP_Type |
| facets | Kind Value pattern [1-9]{1}[0-9]* |

element **Acconti_Irpef_Anno_Imposta_Type/SecondaRataAccontoCedolare**

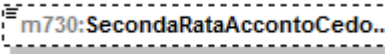
| | |
|-----------|---|
| diagram |  |
| namespace | urn:www.agenziaentrate.gov.it:specificheTecniche:sco:730 |
| type | DatoNP_Type |
| facets | Kind Value pattern [1-9]{1}[0-9]* |

complexType **Acconti_Ritenute_Type**

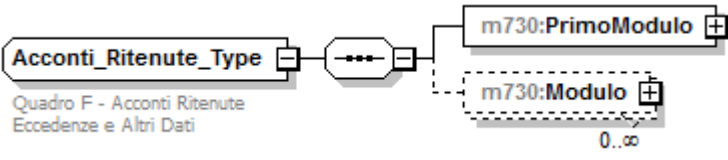
| | |
|-----------|--|
| diagram |  |
| namespace | urn:www.agenziaentrate.gov.it:specificheTecniche:sco:730 |
| children | m730:PrimoModulo m730:Modulo |

element **Acconti_Ritenute_Type/PrimoModulo**

| | |
|-----------|--|
| diagram | |
| namespace | urn:www.agenziaentrate.gov.it:specificheTecniche:sco:730 |
| type | m730:Primo Modulo Acconti Ritenute Type |
| children | m730:Accontilrpef m730:AltreRitenute m730:Eccedenze m730:RitenuteAccontiSospesi m730:MisuraAcconti m730:EsenzioneAddComunale m730:Dati730Integrativo m730:AccontiAltriDati |

element **Acconti_Ritenute_Type/Modulo**

| | |
|-----------|--|
| diagram | |
| namespace | urn:www.agenziaentrate.gov.it:specificheTecniche:sco:730 |
| children | m730:Pignoramento |

element **Acconti_Ritenute_Type/Modulo/Pignoramento**

| | |
|-----------|--|
| diagram | |
| namespace | urn:www.agenziaentrate.gov.it:specificheTecniche:sco:730 |
| children | m730:TipoRedditoPignoramento m730:RitenutePignoramento |

element **Acconti_Ritenute_Type/Modulo/Pignoramento/TipoRedditoPignoramento**

| diagram | | | | | | | | | | | | | | | | | |
|-------------|--|------|-------|---------|-------|-------------|---|-------------|---|-------------|---|-------------|---|-------------|---|-------------|---|
| namespace | urn:www.agenziaentrate.gov.it:specificheTecniche:sco:730 | | | | | | | | | | | | | | | | |
| type | restriction of DatoN1_Type | | | | | | | | | | | | | | | | |
| facets | <table border="1"> <thead> <tr> <th>Kind</th> <th>Value</th> </tr> </thead> <tbody> <tr> <td>pattern</td> <td>[1-9]</td> </tr> <tr> <td>enumeration</td> <td>1</td> </tr> <tr> <td>enumeration</td> <td>2</td> </tr> <tr> <td>enumeration</td> <td>3</td> </tr> <tr> <td>enumeration</td> <td>4</td> </tr> <tr> <td>enumeration</td> <td>5</td> </tr> <tr> <td>enumeration</td> <td>6</td> </tr> </tbody> </table> | Kind | Value | pattern | [1-9] | enumeration | 1 | enumeration | 2 | enumeration | 3 | enumeration | 4 | enumeration | 5 | enumeration | 6 |
| Kind | Value | | | | | | | | | | | | | | | | |
| pattern | [1-9] | | | | | | | | | | | | | | | | |
| enumeration | 1 | | | | | | | | | | | | | | | | |
| enumeration | 2 | | | | | | | | | | | | | | | | |
| enumeration | 3 | | | | | | | | | | | | | | | | |
| enumeration | 4 | | | | | | | | | | | | | | | | |
| enumeration | 5 | | | | | | | | | | | | | | | | |
| enumeration | 6 | | | | | | | | | | | | | | | | |

element **Acconti_Ritenute_Type/Modulo/Pignoramento/RitenutePignoramento**

| diagram | | | | | |
|-----------|---|------|-------|---------|----------------|
| namespace | urn:www.agenziaentrate.gov.it:specificheTecniche:sco:730 | | | | |
| type | DatoNP_Type | | | | |
| facets | <table border="1"> <thead> <tr> <th>Kind</th> <th>Value</th> </tr> </thead> <tbody> <tr> <td>pattern</td> <td>[1-9]{1}[0-9]*</td> </tr> </tbody> </table> | Kind | Value | pattern | [1-9]{1}[0-9]* |
| Kind | Value | | | | |
| pattern | [1-9]{1}[0-9]* | | | | |

complexType **Acquisto_Costruzione_Abit_Locazione**

| | |
|-----------|---|
| diagram | |
| namespace | urn:www.agenziaentrate.gov.it:specificheTecniche:sco:730 |
| children | m730:DataStipula m730:Spesa m730:InteressiMutuo |

element **Acquisto_Costruzione_Abit_Locazione/DataStipula**

| diagram | | | | | |
|-----------|--|------|-------|---------|---|
| namespace | urn:www.agenziaentrate.gov.it:specificheTecniche:sco:730 | | | | |
| type | DatoDT_Type | | | | |
| facets | <table border="1"> <thead> <tr> <th>Kind</th> <th>Value</th> </tr> </thead> <tbody> <tr> <td>pattern</td> <td>((([0-9]{1,12}[0-9]{3}[01])(0[13578][10]12(\d{4})) ([0-9]{1,12}[0-9]{30}(0[469][11](\d{4})) ([0-9]{1,1}[0-9]{2}[0-8])(02(\d{4})) ((29)(02)([02468][048]00)) ((29)(02)([13579][26]00)) ((29)(02)([0-9][0-9][0][48])) ((29)(02)([0-9][0-9][2468][048])) ((29)(02)([0-9][0-9][13579][26]))))</td> </tr> </tbody> </table> | Kind | Value | pattern | ((([0-9]{1,12}[0-9]{3}[01])(0[13578][10]12(\d{4})) ([0-9]{1,12}[0-9]{30}(0[469][11](\d{4})) ([0-9]{1,1}[0-9]{2}[0-8])(02(\d{4})) ((29)(02)([02468][048]00)) ((29)(02)([13579][26]00)) ((29)(02)([0-9][0-9][0][48])) ((29)(02)([0-9][0-9][2468][048])) ((29)(02)([0-9][0-9][13579][26])))) |
| Kind | Value | | | | |
| pattern | ((([0-9]{1,12}[0-9]{3}[01])(0[13578][10]12(\d{4})) ([0-9]{1,12}[0-9]{30}(0[469][11](\d{4})) ([0-9]{1,1}[0-9]{2}[0-8])(02(\d{4})) ((29)(02)([02468][048]00)) ((29)(02)([13579][26]00)) ((29)(02)([0-9][0-9][0][48])) ((29)(02)([0-9][0-9][2468][048])) ((29)(02)([0-9][0-9][13579][26])))) | | | | |

element **Acquisto_Costruzione_Abit_Locazione/Spesa**

| | |
|-----------|--|
| diagram | |
| namespace | urn:www.agenziaentrate.gov.it:specificheTecniche:sco:730 |
| type | DatoNP_Type |
| facets | Kind Value pattern [1-9]{1}[0-9]* |

element **Acquisto_Costruzione_Abit_Locazione/InteressiMutuo**

| | |
|-----------|--|
| diagram | |
| namespace | urn:www.agenziaentrate.gov.it:specificheTecniche:sco:730 |
| type | DatoNP_Type |
| facets | Kind Value pattern [1-9]{1}[0-9]* |

complexType **Addizionali_Type**

| | |
|-----------|---|
| diagram | |
| namespace | urn:www.agenziaentrate.gov.it:specificheTecniche:sco:730 |
| children | m730:Imponibile m730:AddRegDovuta m730:AddRegCertif m730:EccedenzaAddReg m730:AddComDovuta m730:AddComCertif m730:EccedenzaAddCom m730:AccontoAddCom m730:AccontoAddComCertif |

element **Addizionali_Type/Imponibile**

| | |
|-----------|--|
| diagram | |
| namespace | urn:www.agenziaentrate.gov.it:specificheTecniche:sco:730 |

| | |
|--------|--------------------------------------|
| type | DatoNP_Type |
| facets | Kind Value pattern [1-9]{1}[0-9]* |

element Additionali_Type/AddRegDovuta

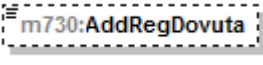
| | |
|-----------|---|
| diagram |  |
| namespace | urn:www.agenziaentrate.gov.it:specificheTecniche:sco:730 |
| type | DatoNP_Type |
| facets | Kind Value pattern [1-9]{1}[0-9]* |

element Additionali_Type/AddRegCertif

| | |
|-----------|---|
| diagram |  |
| namespace | urn:www.agenziaentrate.gov.it:specificheTecniche:sco:730 |
| type | DatoNP_Type |
| facets | Kind Value pattern [1-9]{1}[0-9]* |

element Additionali_Type/EccedenzaAddReg

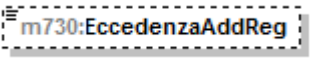
| | |
|-----------|---|
| diagram |  |
| namespace | urn:www.agenziaentrate.gov.it:specificheTecniche:sco:730 |
| type | DatoNU_Type |
| facets | Kind Value pattern (\-[1-9] [1-9])[0-9]* |

element Additionali_Type/AddComDovuta

| | |
|-----------|---|
| diagram |  |
| namespace | urn:www.agenziaentrate.gov.it:specificheTecniche:sco:730 |
| type | DatoNP_Type |
| facets | Kind Value pattern [1-9]{1}[0-9]* |

element Additionali_Type/AddComCertif

| | |
|-----------|---|
| diagram |  |
| namespace | urn:www.agenziaentrate.gov.it:specificheTecniche:sco:730 |

| | |
|--------|--------------------------------------|
| type | DatoNP_Type |
| facets | Kind Value pattern [1-9]{1}[0-9]* |

element Additionali_Type/EccedenzaAddCom

| | |
|-----------|--|
| diagram | |
| namespace | urn:www.agenziaentrate.gov.it:specificheTecniche:sco:730 |
| type | DatoNU_Type |
| facets | Kind Value pattern (\-[1-9] [1-9])[0-9]* |

element Additionali_Type/AccontoAddCom

| | |
|-----------|--|
| diagram | |
| namespace | urn:www.agenziaentrate.gov.it:specificheTecniche:sco:730 |
| type | DatoNP_Type |
| facets | Kind Value pattern [1-9]{1}[0-9]* |

element Additionali_Type/AccontoAddComCertif

| | |
|-----------|--|
| diagram | |
| namespace | urn:www.agenziaentrate.gov.it:specificheTecniche:sco:730 |
| type | DatoNP_Type |
| facets | Kind Value pattern [1-9]{1}[0-9]* |

complexType Altre_Detrazioni_Type

| | |
|-----------|--|
| diagram | |
| namespace | urn:www.agenziaentrate.gov.it:specificheTecniche:sco:730 |
| children | m730:Codice m730:Importo |

element Altre_Detrazioni_Type/Codice

| | |
|---------|--|
| diagram | |
|---------|--|

| | | | | | | | | | |
|-------------|---|------|-------|---------|----------------|-------------|---|-------------|---|
| namespace | urn:www.agenziaentrate.gov.it:specificheTecniche:sco:730 | | | | | | | | |
| type | m730:Codice_Altre_Detrazioni_Type | | | | | | | | |
| facets | <table border="0"> <tr> <td>Kind</td> <td>Value</td> </tr> <tr> <td>pattern</td> <td>[1-9]{1}[0-9]*</td> </tr> <tr> <td>enumeration</td> <td>1</td> </tr> <tr> <td>enumeration</td> <td>2</td> </tr> </table> | Kind | Value | pattern | [1-9]{1}[0-9]* | enumeration | 1 | enumeration | 2 |
| Kind | Value | | | | | | | | |
| pattern | [1-9]{1}[0-9]* | | | | | | | | |
| enumeration | 1 | | | | | | | | |
| enumeration | 2 | | | | | | | | |

element Altre_Detrazioni_Type/Importo

| | | | | | |
|-----------|---|------|-------|---------|----------------|
| diagram | | | | | |
| namespace | urn:www.agenziaentrate.gov.it:specificheTecniche:sco:730 | | | | |
| type | DatoNP_Type | | | | |
| facets | <table border="0"> <tr> <td>Kind</td> <td>Value</td> </tr> <tr> <td>pattern</td> <td>[1-9]{1}[0-9]*</td> </tr> </table> | Kind | Value | pattern | [1-9]{1}[0-9]* |
| Kind | Value | | | | |
| pattern | [1-9]{1}[0-9]* | | | | |

complexType Altre_Ritenute_Type

| | |
|-----------|--|
| diagram | |
| namespace | urn:www.agenziaentrate.gov.it:specificheTecniche:sco:730 |
| children | m730:AltreRitenuteIrpef m730:AddizionaleRegionale m730:AddizionaleComunale m730:AddRegionaleIrpefAttivitaSport m730:AddComunaleIrpefAttivitaSport m730:IrpefLavoriSocialmenteUtili m730:AddRegionaleIrpefLavoriSoc_Utili |

element Altre_Ritenute_Type/AltreRitenuteIrpef

| | | | | | |
|-----------|---|------|-------|---------|----------------|
| diagram | | | | | |
| namespace | urn:www.agenziaentrate.gov.it:specificheTecniche:sco:730 | | | | |
| type | DatoNP_Type | | | | |
| facets | <table border="0"> <tr> <td>Kind</td> <td>Value</td> </tr> <tr> <td>pattern</td> <td>[1-9]{1}[0-9]*</td> </tr> </table> | Kind | Value | pattern | [1-9]{1}[0-9]* |
| Kind | Value | | | | |
| pattern | [1-9]{1}[0-9]* | | | | |

element **Altre_Ritenute_Type/AddizionaleRegionale**

| | |
|-----------|---|
| diagram |  m730:AddizionaleRegionale |
| namespace | urn:www.agenziaentrate.gov.it:specificheTecniche:sco:730 |
| type | DatoNP_Type |
| facets | Kind Value pattern [1-9]{1}[0-9]* |

element **Altre_Ritenute_Type/AddizionaleComunale**

| | |
|-----------|--|
| diagram |  m730:AddizionaleComunale |
| namespace | urn:www.agenziaentrate.gov.it:specificheTecniche:sco:730 |
| type | DatoNP_Type |
| facets | Kind Value pattern [1-9]{1}[0-9]* |

element **Altre_Ritenute_Type/AddRegionaleIrpefAttivitaSport**

| | |
|-----------|---|
| diagram |  m730:AddRegionaleIrpefAttivita... |
| namespace | urn:www.agenziaentrate.gov.it:specificheTecniche:sco:730 |
| type | DatoNP_Type |
| facets | Kind Value pattern [1-9]{1}[0-9]* |

element **Altre_Ritenute_Type/AddComunaleIrpefAttivitaSport**

| | |
|-----------|--|
| diagram |  m730:AddComunaleIrpefAttivita... |
| namespace | urn:www.agenziaentrate.gov.it:specificheTecniche:sco:730 |
| type | DatoNP_Type |
| facets | Kind Value pattern [1-9]{1}[0-9]* |

element **Altre_Ritenute_Type/IrpefLavoriSocialmenteUtili**

| | |
|-----------|--|
| diagram |  m730:IrpefLavoriSocialmenteUtili |
| namespace | urn:www.agenziaentrate.gov.it:specificheTecniche:sco:730 |
| type | DatoNP_Type |
| facets | Kind Value pattern [1-9]{1}[0-9]* |

element **Altre_Ritenute_Type/AddRegionaleIrpefLavoriSoc_Utili**

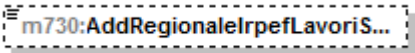
| diagram |  | | | | |
|-----------|---|------|-------|---------|----------------|
| namespace | urn:www.agenziaentrate.gov.it:specificheTecniche:sco:730 | | | | |
| type | DatoNP_Type | | | | |
| facets | <table border="1"> <thead> <tr> <th>Kind</th> <th>Value</th> </tr> </thead> <tbody> <tr> <td>pattern</td> <td>[1-9]{1}[0-9]*</td> </tr> </tbody> </table> | Kind | Value | pattern | [1-9]{1}[0-9]* |
| Kind | Value | | | | |
| pattern | [1-9]{1}[0-9]* | | | | |

complexType **Altre_Spese_Type**

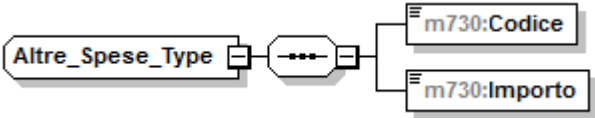
| | |
|-----------|---|
| diagram |  |
| namespace | urn:www.agenziaentrate.gov.it:specificheTecniche:sco:730 |
| children | m730:Codice m730:Importo |

element **Altre_Spese_Type/Codice**

| diagram |  | | | | | | | | | | | | | | | | | | | | | | | | | | | | | | | | | | | | | | | | | | | | | | | | | | | | | | | | | | | | | | | | |
|-------------|---|------|-------|---------|----------------|-------------|---|-------------|---|-------------|----|-------------|----|-------------|----|-------------|----|-------------|----|-------------|----|-------------|----|-------------|----|-------------|----|-------------|----|-------------|----|-------------|----|-------------|----|-------------|----|-------------|----|-------------|----|-------------|----|-------------|----|-------------|----|-------------|----|-------------|----|-------------|----|-------------|----|-------------|----|-------------|----|-------------|----|-------------|----|-------------|----|
| namespace | urn:www.agenziaentrate.gov.it:specificheTecniche:sco:730 | | | | | | | | | | | | | | | | | | | | | | | | | | | | | | | | | | | | | | | | | | | | | | | | | | | | | | | | | | | | | | | | |
| type | m730:Codice Altre_Spese_Type | | | | | | | | | | | | | | | | | | | | | | | | | | | | | | | | | | | | | | | | | | | | | | | | | | | | | | | | | | | | | | | | |
| facets | <table border="1"> <thead> <tr> <th>Kind</th> <th>Value</th> </tr> </thead> <tbody> <tr> <td>pattern</td> <td>[1-9]{1}[0-9]*</td> </tr> <tr><td>enumeration</td><td>8</td></tr> <tr><td>enumeration</td><td>9</td></tr> <tr><td>enumeration</td><td>10</td></tr> <tr><td>enumeration</td><td>11</td></tr> <tr><td>enumeration</td><td>13</td></tr> <tr><td>enumeration</td><td>14</td></tr> <tr><td>enumeration</td><td>15</td></tr> <tr><td>enumeration</td><td>16</td></tr> <tr><td>enumeration</td><td>17</td></tr> <tr><td>enumeration</td><td>18</td></tr> <tr><td>enumeration</td><td>20</td></tr> <tr><td>enumeration</td><td>21</td></tr> <tr><td>enumeration</td><td>22</td></tr> <tr><td>enumeration</td><td>23</td></tr> <tr><td>enumeration</td><td>24</td></tr> <tr><td>enumeration</td><td>25</td></tr> <tr><td>enumeration</td><td>26</td></tr> <tr><td>enumeration</td><td>27</td></tr> <tr><td>enumeration</td><td>28</td></tr> <tr><td>enumeration</td><td>29</td></tr> <tr><td>enumeration</td><td>30</td></tr> <tr><td>enumeration</td><td>31</td></tr> <tr><td>enumeration</td><td>32</td></tr> <tr><td>enumeration</td><td>33</td></tr> <tr><td>enumeration</td><td>35</td></tr> <tr><td>enumeration</td><td>36</td></tr> <tr><td>enumeration</td><td>37</td></tr> <tr><td>enumeration</td><td>41</td></tr> <tr><td>enumeration</td><td>42</td></tr> <tr><td>enumeration</td><td>99</td></tr> </tbody> </table> | Kind | Value | pattern | [1-9]{1}[0-9]* | enumeration | 8 | enumeration | 9 | enumeration | 10 | enumeration | 11 | enumeration | 13 | enumeration | 14 | enumeration | 15 | enumeration | 16 | enumeration | 17 | enumeration | 18 | enumeration | 20 | enumeration | 21 | enumeration | 22 | enumeration | 23 | enumeration | 24 | enumeration | 25 | enumeration | 26 | enumeration | 27 | enumeration | 28 | enumeration | 29 | enumeration | 30 | enumeration | 31 | enumeration | 32 | enumeration | 33 | enumeration | 35 | enumeration | 36 | enumeration | 37 | enumeration | 41 | enumeration | 42 | enumeration | 99 |
| Kind | Value | | | | | | | | | | | | | | | | | | | | | | | | | | | | | | | | | | | | | | | | | | | | | | | | | | | | | | | | | | | | | | | | |
| pattern | [1-9]{1}[0-9]* | | | | | | | | | | | | | | | | | | | | | | | | | | | | | | | | | | | | | | | | | | | | | | | | | | | | | | | | | | | | | | | | |
| enumeration | 8 | | | | | | | | | | | | | | | | | | | | | | | | | | | | | | | | | | | | | | | | | | | | | | | | | | | | | | | | | | | | | | | | |
| enumeration | 9 | | | | | | | | | | | | | | | | | | | | | | | | | | | | | | | | | | | | | | | | | | | | | | | | | | | | | | | | | | | | | | | | |
| enumeration | 10 | | | | | | | | | | | | | | | | | | | | | | | | | | | | | | | | | | | | | | | | | | | | | | | | | | | | | | | | | | | | | | | | |
| enumeration | 11 | | | | | | | | | | | | | | | | | | | | | | | | | | | | | | | | | | | | | | | | | | | | | | | | | | | | | | | | | | | | | | | | |
| enumeration | 13 | | | | | | | | | | | | | | | | | | | | | | | | | | | | | | | | | | | | | | | | | | | | | | | | | | | | | | | | | | | | | | | | |
| enumeration | 14 | | | | | | | | | | | | | | | | | | | | | | | | | | | | | | | | | | | | | | | | | | | | | | | | | | | | | | | | | | | | | | | | |
| enumeration | 15 | | | | | | | | | | | | | | | | | | | | | | | | | | | | | | | | | | | | | | | | | | | | | | | | | | | | | | | | | | | | | | | | |
| enumeration | 16 | | | | | | | | | | | | | | | | | | | | | | | | | | | | | | | | | | | | | | | | | | | | | | | | | | | | | | | | | | | | | | | | |
| enumeration | 17 | | | | | | | | | | | | | | | | | | | | | | | | | | | | | | | | | | | | | | | | | | | | | | | | | | | | | | | | | | | | | | | | |
| enumeration | 18 | | | | | | | | | | | | | | | | | | | | | | | | | | | | | | | | | | | | | | | | | | | | | | | | | | | | | | | | | | | | | | | | |
| enumeration | 20 | | | | | | | | | | | | | | | | | | | | | | | | | | | | | | | | | | | | | | | | | | | | | | | | | | | | | | | | | | | | | | | | |
| enumeration | 21 | | | | | | | | | | | | | | | | | | | | | | | | | | | | | | | | | | | | | | | | | | | | | | | | | | | | | | | | | | | | | | | | |
| enumeration | 22 | | | | | | | | | | | | | | | | | | | | | | | | | | | | | | | | | | | | | | | | | | | | | | | | | | | | | | | | | | | | | | | | |
| enumeration | 23 | | | | | | | | | | | | | | | | | | | | | | | | | | | | | | | | | | | | | | | | | | | | | | | | | | | | | | | | | | | | | | | | |
| enumeration | 24 | | | | | | | | | | | | | | | | | | | | | | | | | | | | | | | | | | | | | | | | | | | | | | | | | | | | | | | | | | | | | | | | |
| enumeration | 25 | | | | | | | | | | | | | | | | | | | | | | | | | | | | | | | | | | | | | | | | | | | | | | | | | | | | | | | | | | | | | | | | |
| enumeration | 26 | | | | | | | | | | | | | | | | | | | | | | | | | | | | | | | | | | | | | | | | | | | | | | | | | | | | | | | | | | | | | | | | |
| enumeration | 27 | | | | | | | | | | | | | | | | | | | | | | | | | | | | | | | | | | | | | | | | | | | | | | | | | | | | | | | | | | | | | | | | |
| enumeration | 28 | | | | | | | | | | | | | | | | | | | | | | | | | | | | | | | | | | | | | | | | | | | | | | | | | | | | | | | | | | | | | | | | |
| enumeration | 29 | | | | | | | | | | | | | | | | | | | | | | | | | | | | | | | | | | | | | | | | | | | | | | | | | | | | | | | | | | | | | | | | |
| enumeration | 30 | | | | | | | | | | | | | | | | | | | | | | | | | | | | | | | | | | | | | | | | | | | | | | | | | | | | | | | | | | | | | | | | |
| enumeration | 31 | | | | | | | | | | | | | | | | | | | | | | | | | | | | | | | | | | | | | | | | | | | | | | | | | | | | | | | | | | | | | | | | |
| enumeration | 32 | | | | | | | | | | | | | | | | | | | | | | | | | | | | | | | | | | | | | | | | | | | | | | | | | | | | | | | | | | | | | | | | |
| enumeration | 33 | | | | | | | | | | | | | | | | | | | | | | | | | | | | | | | | | | | | | | | | | | | | | | | | | | | | | | | | | | | | | | | | |
| enumeration | 35 | | | | | | | | | | | | | | | | | | | | | | | | | | | | | | | | | | | | | | | | | | | | | | | | | | | | | | | | | | | | | | | | |
| enumeration | 36 | | | | | | | | | | | | | | | | | | | | | | | | | | | | | | | | | | | | | | | | | | | | | | | | | | | | | | | | | | | | | | | | |
| enumeration | 37 | | | | | | | | | | | | | | | | | | | | | | | | | | | | | | | | | | | | | | | | | | | | | | | | | | | | | | | | | | | | | | | | |
| enumeration | 41 | | | | | | | | | | | | | | | | | | | | | | | | | | | | | | | | | | | | | | | | | | | | | | | | | | | | | | | | | | | | | | | | |
| enumeration | 42 | | | | | | | | | | | | | | | | | | | | | | | | | | | | | | | | | | | | | | | | | | | | | | | | | | | | | | | | | | | | | | | | |
| enumeration | 99 | | | | | | | | | | | | | | | | | | | | | | | | | | | | | | | | | | | | | | | | | | | | | | | | | | | | | | | | | | | | | | | | |

element **Altre_Spese_Type/Importo**

| | |
|-----------|--|
| diagram | |
| namespace | urn:www.agenziaentrate.gov.it:specificheTecniche:sco:730 |
| type | DatoNP_Type |
| facets | Kind Value pattern [1-9]{1}[0-9]* |

complexType **Altri_Dati_Type**

| | |
|-----------|---|
| diagram | |
| namespace | urn:www.agenziaentrate.gov.it:specificheTecniche:sco:730 |
| children | m730:ResiduoCreditoErogazioneCultura m730:ResiduoCreditoPrimaCasa m730:ResiduoCreditoOccupazione m730:ResiduoCreditoSisma m730:ResiduoCreditoFondiPensione m730:ResiduoCreditoMediazioni m730:TotSpeseSanitarieRateizzate m730:RedditoAgevolazioniFiscali m730:RedditoComplessivoAcconto m730:RigoDifferenzaAcconto m730:RedditiFondiariniNonImponibili m730:RedditoAbitazionePrincipalePertinenze m730:ResiduoDeduzioneSommeRestituite |

element **Altri_Dati_Type/ResiduoCreditoErogazioneCultura**

| | |
|-----------|---|
| diagram |  m730:ResiduoCreditoErogazion... |
| namespace | urn:www.agenziaentrate.gov.it:specificheTecniche:sco:730 |
| type | DatoNP_Type |
| facets | Kind Value pattern [1-9]{1}[0-9]* |

element **Altri_Dati_Type/ResiduoCreditoPrimaCasa**

| | |
|-----------|--|
| diagram |  m730:ResiduoCreditoPrimaCasa |
| namespace | urn:www.agenziaentrate.gov.it:specificheTecniche:sco:730 |
| type | DatoNP_Type |
| facets | Kind Value pattern [1-9]{1}[0-9]* |

element **Altri_Dati_Type/ResiduoCreditoOccupazione**

| | |
|-----------|---|
| diagram |  m730:ResiduoCreditoOccupazio... |
| namespace | urn:www.agenziaentrate.gov.it:specificheTecniche:sco:730 |
| type | DatoNP_Type |
| facets | Kind Value pattern [1-9]{1}[0-9]* |

element **Altri_Dati_Type/ResiduoCreditoSisma**

| | |
|-----------|--|
| diagram |  m730:ResiduoCreditoSisma |
| namespace | urn:www.agenziaentrate.gov.it:specificheTecniche:sco:730 |
| type | DatoNP_Type |
| facets | Kind Value pattern [1-9]{1}[0-9]* |

element **Altri_Dati_Type/ResiduoCreditoFondiPensione**

| | |
|-----------|---|
| diagram |  m730:ResiduoCreditoFondiPens... |
| namespace | urn:www.agenziaentrate.gov.it:specificheTecniche:sco:730 |
| type | DatoNP_Type |
| facets | Kind Value pattern [1-9]{1}[0-9]* |

element **Altri_Dati_Type/ResiduoCreditoMediazioni**

| | | | | | |
|-----------|---|------|-------|---------|----------------|
| diagram |  m730:ResiduoCreditoMediazioni | | | | |
| namespace | urn:www.agenziaentrate.gov.it:specificheTecniche:sco:730 | | | | |
| type | DatoNP_Type | | | | |
| facets | <table border="1"> <tr> <td>Kind</td> <td>Value</td> </tr> <tr> <td>pattern</td> <td>[1-9]{1}[0-9]*</td> </tr> </table> | Kind | Value | pattern | [1-9]{1}[0-9]* |
| Kind | Value | | | | |
| pattern | [1-9]{1}[0-9]* | | | | |

element **Altri_Dati_Type/TotSpeseSanitarieRateizzate**

| | | | | | |
|-----------|--|------|-------|---------|----------------|
| diagram |  m730:TotSpeseSanitarieRateizza... | | | | |
| namespace | urn:www.agenziaentrate.gov.it:specificheTecniche:sco:730 | | | | |
| type | DatoNP_Type | | | | |
| facets | <table border="1"> <tr> <td>Kind</td> <td>Value</td> </tr> <tr> <td>pattern</td> <td>[1-9]{1}[0-9]*</td> </tr> </table> | Kind | Value | pattern | [1-9]{1}[0-9]* |
| Kind | Value | | | | |
| pattern | [1-9]{1}[0-9]* | | | | |

element **Altri_Dati_Type/RedditoAgevolazioniFiscali**

| | | | | | |
|-----------|--|------|-------|---------|----------------|
| diagram |  m730:RedditoAgevolazioniFiscali | | | | |
| namespace | urn:www.agenziaentrate.gov.it:specificheTecniche:sco:730 | | | | |
| type | DatoNP_Type | | | | |
| facets | <table border="1"> <tr> <td>Kind</td> <td>Value</td> </tr> <tr> <td>pattern</td> <td>[1-9]{1}[0-9]*</td> </tr> </table> | Kind | Value | pattern | [1-9]{1}[0-9]* |
| Kind | Value | | | | |
| pattern | [1-9]{1}[0-9]* | | | | |

element **Altri_Dati_Type/RedditoComplessivoAcconto**

| | | | | | |
|-----------|---|------|-------|---------|----------------|
| diagram |  m730:RedditoComplessivoAcco... | | | | |
| namespace | urn:www.agenziaentrate.gov.it:specificheTecniche:sco:730 | | | | |
| type | DatoNP_Type | | | | |
| facets | <table border="1"> <tr> <td>Kind</td> <td>Value</td> </tr> <tr> <td>pattern</td> <td>[1-9]{1}[0-9]*</td> </tr> </table> | Kind | Value | pattern | [1-9]{1}[0-9]* |
| Kind | Value | | | | |
| pattern | [1-9]{1}[0-9]* | | | | |

element **Altri_Dati_Type/RigoDifferenzaAcconto**

| | | | | | |
|-----------|--|------|-------|---------|-----------------------|
| diagram |  m730:RigoDifferenzaAcconto | | | | |
| namespace | urn:www.agenziaentrate.gov.it:specificheTecniche:sco:730 | | | | |
| type | DatoNU_Type | | | | |
| facets | <table border="1"> <tr> <td>Kind</td> <td>Value</td> </tr> <tr> <td>pattern</td> <td>(\-[1-9] [1-9])[0-9]*</td> </tr> </table> | Kind | Value | pattern | (\-[1-9] [1-9])[0-9]* |
| Kind | Value | | | | |
| pattern | (\-[1-9] [1-9])[0-9]* | | | | |

element Altri_Dati_Type/RedditiFondariNonImponibili

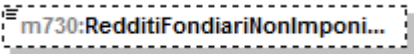
| | | | | | |
|-----------|---|------|-------|---------|----------------|
| diagram |  | | | | |
| namespace | urn:www.agenziaentrate.gov.it:specificheTecniche:sco:730 | | | | |
| type | DatoNP_Type | | | | |
| facets | <table border="0"> <tr> <td>Kind</td> <td>Value</td> </tr> <tr> <td>pattern</td> <td>[1-9]{1}[0-9]*</td> </tr> </table> | Kind | Value | pattern | [1-9]{1}[0-9]* |
| Kind | Value | | | | |
| pattern | [1-9]{1}[0-9]* | | | | |

element Altri_Dati_Type/RedditoAbitazionePrincipalePertinenze

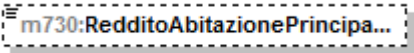
| | | | | | |
|-----------|---|------|-------|---------|----------------|
| diagram |  | | | | |
| namespace | urn:www.agenziaentrate.gov.it:specificheTecniche:sco:730 | | | | |
| type | DatoNP_Type | | | | |
| facets | <table border="0"> <tr> <td>Kind</td> <td>Value</td> </tr> <tr> <td>pattern</td> <td>[1-9]{1}[0-9]*</td> </tr> </table> | Kind | Value | pattern | [1-9]{1}[0-9]* |
| Kind | Value | | | | |
| pattern | [1-9]{1}[0-9]* | | | | |

element Altri_Dati_Type/ResiduoDeduzioneSommeRestituite

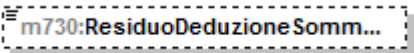
| | | | | | |
|-----------|---|------|-------|---------|----------------|
| diagram |  | | | | |
| namespace | urn:www.agenziaentrate.gov.it:specificheTecniche:sco:730 | | | | |
| type | DatoNP_Type | | | | |
| facets | <table border="0"> <tr> <td>Kind</td> <td>Value</td> </tr> <tr> <td>pattern</td> <td>[1-9]{1}[0-9]*</td> </tr> </table> | Kind | Value | pattern | [1-9]{1}[0-9]* |
| Kind | Value | | | | |
| pattern | [1-9]{1}[0-9]* | | | | |

complexType Altri_Oneri_Type

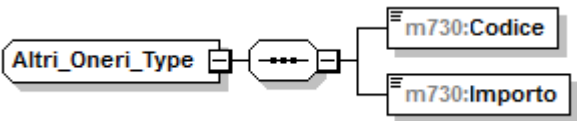
| | |
|-----------|---|
| diagram |  |
| namespace | urn:www.agenziaentrate.gov.it:specificheTecniche:sco:730 |
| children | m730:Codice m730:Importo |

element Altri_Oneri_Type/Codice

| | | | | | | | | | |
|-------------|---|------|-------|---------|----------------|-------------|---|-------------|---|
| diagram |  | | | | | | | | |
| namespace | urn:www.agenziaentrate.gov.it:specificheTecniche:sco:730 | | | | | | | | |
| type | m730:Codice Altri_Oneri_Type | | | | | | | | |
| facets | <table border="0"> <tr> <td>Kind</td> <td>Value</td> </tr> <tr> <td>pattern</td> <td>[1-9]{1}[0-9]*</td> </tr> <tr> <td>enumeration</td> <td>1</td> </tr> <tr> <td>enumeration</td> <td>2</td> </tr> </table> | Kind | Value | pattern | [1-9]{1}[0-9]* | enumeration | 1 | enumeration | 2 |
| Kind | Value | | | | | | | | |
| pattern | [1-9]{1}[0-9]* | | | | | | | | |
| enumeration | 1 | | | | | | | | |
| enumeration | 2 | | | | | | | | |

| | | |
|--|-------------|---|
| | enumeration | 3 |
| | enumeration | 4 |
| | enumeration | 5 |
| | enumeration | 6 |

element Altri_Oneri_Type/Importo

| | | | | | |
|-----------|---|------|-------|---------|----------------|
| diagram | | | | | |
| namespace | urn:www.agenziaentrate.gov.it:specificheTecniche:sco:730 | | | | |
| type | DatoNP_Type | | | | |
| facets | <table border="1"> <tr> <td>Kind</td> <td>Value</td> </tr> <tr> <td>pattern</td> <td>[1-9]{1}[0-9]*</td> </tr> </table> | Kind | Value | pattern | [1-9]{1}[0-9]* |
| Kind | Value | | | | |
| pattern | [1-9]{1}[0-9]* | | | | |

complexType Altri_Redditi_Ass_Lavd_Type

| | |
|-----------|--|
| diagram | |
| namespace | urn:www.agenziaentrate.gov.it:specificheTecniche:sco:730 |
| children | m730:AssegnoDelConiuge m730:ImportoRedditoAssimilato |

element Altri_Redditi_Ass_Lavd_Type/AssegnoDelConiuge

| | | | | | |
|-----------|---|------|-------|---------|------|
| diagram | | | | | |
| namespace | urn:www.agenziaentrate.gov.it:specificheTecniche:sco:730 | | | | |
| type | DatoCB_Type | | | | |
| facets | <table border="1"> <tr> <td>Kind</td> <td>Value</td> </tr> <tr> <td>pattern</td> <td>[01]</td> </tr> </table> | Kind | Value | pattern | [01] |
| Kind | Value | | | | |
| pattern | [01] | | | | |

element Altri_Redditi_Ass_Lavd_Type/ImportoRedditoAssimilato

| | | | | | |
|-----------|---|------|-------|---------|----------------|
| diagram | | | | | |
| namespace | urn:www.agenziaentrate.gov.it:specificheTecniche:sco:730 | | | | |
| type | DatoNP_Type | | | | |
| facets | <table border="1"> <tr> <td>Kind</td> <td>Value</td> </tr> <tr> <td>pattern</td> <td>[1-9]{1}[0-9]*</td> </tr> </table> | Kind | Value | pattern | [1-9]{1}[0-9]* |
| Kind | Value | | | | |
| pattern | [1-9]{1}[0-9]* | | | | |

complexType Altri_Reddito_Diversi_Detr_Type

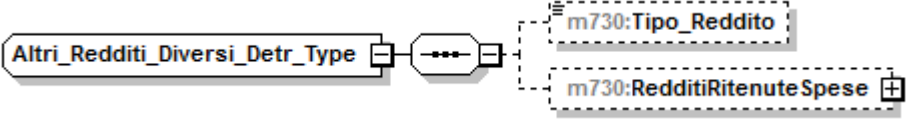
| | |
|-----------|--|
| diagram |  |
| namespace | urn:www.agenziaentrate.gov.it:specificheTecniche:sco:730 |
| children | m730:Tipo_Reddito m730:RedditoRitenuteSpese |

element Altri_Reddito_Diversi_Detr_Type/Tipo_Reddito

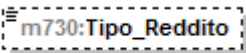
| diagram |  | | | | | | | | | | | | |
|-------------|--|------|-------|---------|-------|-------------|---|-------------|---|-------------|---|-------------|---|
| namespace | urn:www.agenziaentrate.gov.it:specificheTecniche:sco:730 | | | | | | | | | | | | |
| type | m730:Tipo_Reddito_Da1a4_Type | | | | | | | | | | | | |
| facets | <table border="1"> <thead> <tr> <th>Kind</th> <th>Value</th> </tr> </thead> <tbody> <tr> <td>pattern</td> <td>[1-9]</td> </tr> <tr> <td>enumeration</td> <td>1</td> </tr> <tr> <td>enumeration</td> <td>2</td> </tr> <tr> <td>enumeration</td> <td>3</td> </tr> <tr> <td>enumeration</td> <td>4</td> </tr> </tbody> </table> | Kind | Value | pattern | [1-9] | enumeration | 1 | enumeration | 2 | enumeration | 3 | enumeration | 4 |
| Kind | Value | | | | | | | | | | | | |
| pattern | [1-9] | | | | | | | | | | | | |
| enumeration | 1 | | | | | | | | | | | | |
| enumeration | 2 | | | | | | | | | | | | |
| enumeration | 3 | | | | | | | | | | | | |
| enumeration | 4 | | | | | | | | | | | | |

element Altri_Reddito_Diversi_Detr_Type/RedditoRitenuteSpese

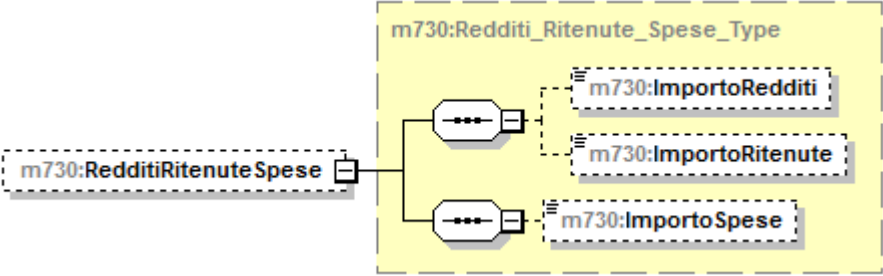
| | |
|-----------|--|
| diagram |  |
| namespace | urn:www.agenziaentrate.gov.it:specificheTecniche:sco:730 |
| type | m730:Reddito_Ritenute_Spese_Type |
| children | m730:ImportoReddito m730:ImportoRitenute m730:ImportoSpese |

complexType Altri_Reddito_Diversi_Type

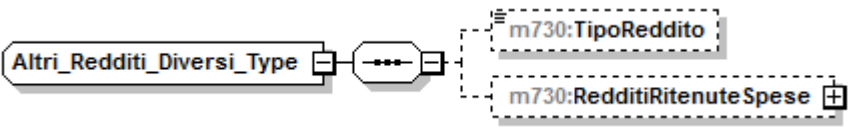
| | |
|-----------|--|
| diagram |  |
| namespace | urn:www.agenziaentrate.gov.it:specificheTecniche:sco:730 |
| children | m730:TipoReddito m730:RedditoRitenuteSpese |

element **Altri_Reddito_Diversi_Type/TipoReddito**

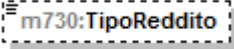
| diagram |  | | | | | | | | | | | | | | | | | | | | | | |
|-------------|--|------|-------|---------|----------------|-------------|---|-------------|---|-------------|---|-------------|---|-------------|---|-------------|---|-------------|---|-------------|---|-------------|---|
| namespace | urn:www.agenziaentrate.gov.it:specificheTecniche:sco:730 | | | | | | | | | | | | | | | | | | | | | | |
| type | m730:Tipo_Reddito_Da1a9_Type | | | | | | | | | | | | | | | | | | | | | | |
| facets | <table border="1"> <thead> <tr> <th>Kind</th> <th>Value</th> </tr> </thead> <tbody> <tr> <td>pattern</td> <td>[1-9]{1}[0-9]*</td> </tr> <tr> <td>enumeration</td> <td>1</td> </tr> <tr> <td>enumeration</td> <td>2</td> </tr> <tr> <td>enumeration</td> <td>3</td> </tr> <tr> <td>enumeration</td> <td>4</td> </tr> <tr> <td>enumeration</td> <td>5</td> </tr> <tr> <td>enumeration</td> <td>6</td> </tr> <tr> <td>enumeration</td> <td>7</td> </tr> <tr> <td>enumeration</td> <td>8</td> </tr> <tr> <td>enumeration</td> <td>9</td> </tr> </tbody> </table> | Kind | Value | pattern | [1-9]{1}[0-9]* | enumeration | 1 | enumeration | 2 | enumeration | 3 | enumeration | 4 | enumeration | 5 | enumeration | 6 | enumeration | 7 | enumeration | 8 | enumeration | 9 |
| Kind | Value | | | | | | | | | | | | | | | | | | | | | | |
| pattern | [1-9]{1}[0-9]* | | | | | | | | | | | | | | | | | | | | | | |
| enumeration | 1 | | | | | | | | | | | | | | | | | | | | | | |
| enumeration | 2 | | | | | | | | | | | | | | | | | | | | | | |
| enumeration | 3 | | | | | | | | | | | | | | | | | | | | | | |
| enumeration | 4 | | | | | | | | | | | | | | | | | | | | | | |
| enumeration | 5 | | | | | | | | | | | | | | | | | | | | | | |
| enumeration | 6 | | | | | | | | | | | | | | | | | | | | | | |
| enumeration | 7 | | | | | | | | | | | | | | | | | | | | | | |
| enumeration | 8 | | | | | | | | | | | | | | | | | | | | | | |
| enumeration | 9 | | | | | | | | | | | | | | | | | | | | | | |

element **Altri_Reddito_Diversi_Type/RedditiRitenuteSpese**

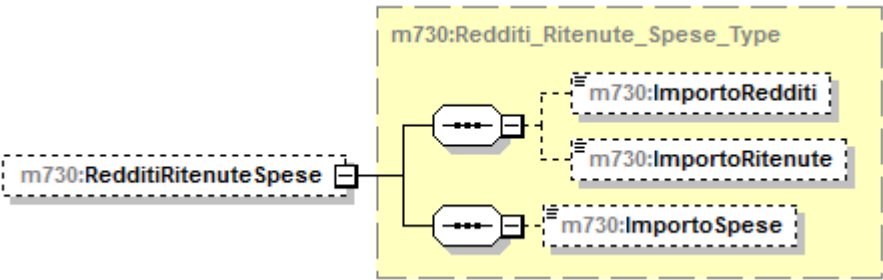
| | |
|-----------|--|
| diagram |  |
| namespace | urn:www.agenziaentrate.gov.it:specificheTecniche:sco:730 |
| type | m730:Redditi_Ritenute_Spese_Type |
| children | m730:ImportoRedditi m730:ImportoRitenute m730:ImportoSpese |

complexType **Altri_Reddito_Lavoro_Autonomo_Type**

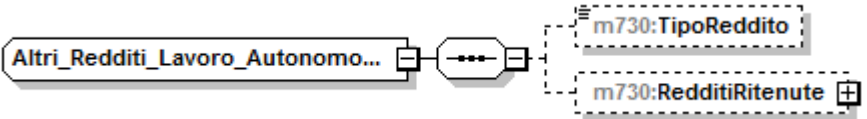
| | |
|-----------|--|
| diagram |  |
| namespace | urn:www.agenziaentrate.gov.it:specificheTecniche:sco:730 |
| children | m730:TipoReddito m730:RedditiRitenute |

element **Altri_Reddito_Lavoro_Autonomo_Type/TipoReddito**

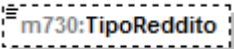
| | |
|-----------|---|
| diagram |  |
| namespace | urn:www.agenziaentrate.gov.it:specificheTecniche:sco:730 |
| type | m730:Tipo_Reddito_Da1a3_Type |

| | | |
|--------|-------------|-------|
| facets | Kind | Value |
| | pattern | [1-9] |
| | enumeration | 1 |
| | enumeration | 2 |
| | enumeration | 3 |

element **Altri_Reddito_Lavoro_Autonomo_Type/RedditoRitenute**

| | |
|-----------|--|
| diagram | |
| namespace | urn:www.agenziaentrate.gov.it:specificheTecniche:sco:730 |
| type | m730:RedditoRitenute_Type |
| children | m730:ImportoReddito m730:ImportoRitenute |

complexType **Altri_Reddito_Type**

| | |
|-----------|--|
| diagram | |
| namespace | urn:www.agenziaentrate.gov.it:specificheTecniche:sco:730 |
| children | m730:Modulo |

element **Altri_Reddito_Type/Modulo**

| | |
|-----------|---|
| diagram | |
| namespace | urn:www.agenziaentrate.gov.it:specificheTecniche:sco:730 |
| type | m730:Modulo_Altri_Reddito_Type |
| children | m730:RedditoDiCapitale m730:RedditoTassazioneSeparata |

complexType **Altri_Reddito_Utili_Type**

| | |
|---------|--|
| diagram | |
|---------|--|

| | |
|-----------|--|
| namespace | urn:www.agenziaentrate.gov.it:specificheTecniche:sco:730 |
| children | m730:Tipo_Reddito m730:RedditiRitenute |

element Altri_Redditi_Utili_Type/Tipo_Reddito

| diagram | | | | | | | | | | | | | | | | | |
|-------------|--|------|-------|---------|-------|-------------|---|-------------|---|-------------|---|-------------|---|-------------|---|-------------|---|
| namespace | urn:www.agenziaentrate.gov.it:specificheTecniche:sco:730 | | | | | | | | | | | | | | | | |
| type | m730:Tipo_Reddito Da1a6 Type | | | | | | | | | | | | | | | | |
| facets | <table border="1"> <thead> <tr> <th>Kind</th> <th>Value</th> </tr> </thead> <tbody> <tr> <td>pattern</td> <td>[1-9]</td> </tr> <tr> <td>enumeration</td> <td>1</td> </tr> <tr> <td>enumeration</td> <td>2</td> </tr> <tr> <td>enumeration</td> <td>3</td> </tr> <tr> <td>enumeration</td> <td>4</td> </tr> <tr> <td>enumeration</td> <td>5</td> </tr> <tr> <td>enumeration</td> <td>6</td> </tr> </tbody> </table> | Kind | Value | pattern | [1-9] | enumeration | 1 | enumeration | 2 | enumeration | 3 | enumeration | 4 | enumeration | 5 | enumeration | 6 |
| Kind | Value | | | | | | | | | | | | | | | | |
| pattern | [1-9] | | | | | | | | | | | | | | | | |
| enumeration | 1 | | | | | | | | | | | | | | | | |
| enumeration | 2 | | | | | | | | | | | | | | | | |
| enumeration | 3 | | | | | | | | | | | | | | | | |
| enumeration | 4 | | | | | | | | | | | | | | | | |
| enumeration | 5 | | | | | | | | | | | | | | | | |
| enumeration | 6 | | | | | | | | | | | | | | | | |

element Altri_Redditi_Utili_Type/RedditiRitenute

| | |
|-----------|--|
| diagram | |
| namespace | urn:www.agenziaentrate.gov.it:specificheTecniche:sco:730 |
| type | m730:Redditi Ritenute Type |
| children | m730:ImportoRedditi m730:ImportoRitenute |

complexType Assegno_Coniuge_Type

| | |
|-----------|---|
| diagram | |
| namespace | urn:www.agenziaentrate.gov.it:specificheTecniche:sco:730 |
| children | m730:CodiceFiscale m730:Importo |

element Assegno_Coniuge_Type/CodiceFiscale

| | |
|-----------|--|
| diagram | |
| namespace | urn:www.agenziaentrate.gov.it:specificheTecniche:sco:730 |

| | | | | | |
|---------|--|------|-------|---------|---|
| type | DatoCF_Type | | | | |
| facets | <table border="1"> <tr> <td>Kind</td> <td>Value</td> </tr> <tr> <td>pattern</td> <td>[0-9]{11}[A-Z]{6}[0-9LMNPQRSTUVWXYZ]{2}[A-Z]{1}[0-9LMNPQRSTUVWXYZ]{2}[A-Z]{1}[0-9LMNPQRSTUVWXYZ]{3}[A-Z]{1}</td> </tr> </table> | Kind | Value | pattern | [0-9]{11}[A-Z]{6}[0-9LMNPQRSTUVWXYZ]{2}[A-Z]{1}[0-9LMNPQRSTUVWXYZ]{2}[A-Z]{1}[0-9LMNPQRSTUVWXYZ]{3}[A-Z]{1} |
| Kind | Value | | | | |
| pattern | [0-9]{11}[A-Z]{6}[0-9LMNPQRSTUVWXYZ]{2}[A-Z]{1}[0-9LMNPQRSTUVWXYZ]{2}[A-Z]{1}[0-9LMNPQRSTUVWXYZ]{3}[A-Z]{1} | | | | |

element Assegno_Coniuge_Type/Importo

| | | | | | |
|-----------|---|------|-------|---------|----------------|
| diagram | | | | | |
| namespace | urn:www.agenziaentrate.gov.it:specificheTecniche:sco:730 | | | | |
| type | DatoNP_Type | | | | |
| facets | <table border="1"> <tr> <td>Kind</td> <td>Value</td> </tr> <tr> <td>pattern</td> <td>[1-9]{1}[0-9]*</td> </tr> </table> | Kind | Value | pattern | [1-9]{1}[0-9]* |
| Kind | Value | | | | |
| pattern | [1-9]{1}[0-9]* | | | | |

complexType Bonus_Irpef_Type

| | |
|-----------|--|
| diagram | |
| namespace | urn:www.agenziaentrate.gov.it:specificheTecniche:sco:730 |
| children | m730:CodiceBonus m730:BonusErogato |

element Bonus_Irpef_Type/CodiceBonus

| | | | | | | | | | |
|-------------|--|------|-------|---------|-------|-------------|---|-------------|---|
| diagram | | | | | | | | | |
| namespace | urn:www.agenziaentrate.gov.it:specificheTecniche:sco:730 | | | | | | | | |
| type | restriction of DatoN1_Type | | | | | | | | |
| facets | <table border="1"> <tr> <td>Kind</td> <td>Value</td> </tr> <tr> <td>pattern</td> <td>[1-9]</td> </tr> <tr> <td>enumeration</td> <td>1</td> </tr> <tr> <td>enumeration</td> <td>2</td> </tr> </table> | Kind | Value | pattern | [1-9] | enumeration | 1 | enumeration | 2 |
| Kind | Value | | | | | | | | |
| pattern | [1-9] | | | | | | | | |
| enumeration | 1 | | | | | | | | |
| enumeration | 2 | | | | | | | | |

element Bonus_Irpef_Type/BonusErogato

| | | | | | |
|-----------|---|------|-------|---------|----------------|
| diagram | | | | | |
| namespace | urn:www.agenziaentrate.gov.it:specificheTecniche:sco:730 | | | | |
| type | DatoNP_Type | | | | |
| facets | <table border="1"> <tr> <td>Kind</td> <td>Value</td> </tr> <tr> <td>pattern</td> <td>[1-9]{1}[0-9]*</td> </tr> </table> | Kind | Value | pattern | [1-9]{1}[0-9]* |
| Kind | Value | | | | |
| pattern | [1-9]{1}[0-9]* | | | | |

complexType Casella_Aconto_Type

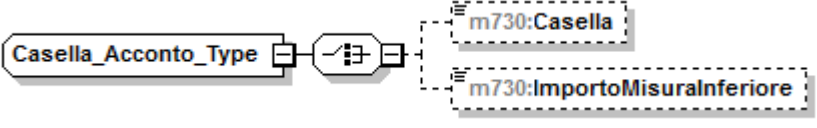
| | |
|-----------|--|
| diagram |  |
| namespace | urn:www.agenziaentrate.gov.it:specificheTecniche:sco:730 |
| children | m730:Casella m730:ImportoMisuralInferiore |

element Casella_Aconto_Type/Casella

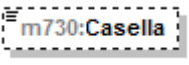
| | | | | | |
|-----------|---|------|-------|---------|------|
| diagram |  | | | | |
| namespace | urn:www.agenziaentrate.gov.it:specificheTecniche:sco:730 | | | | |
| type | DatoCB_Type | | | | |
| facets | <table border="1"> <tr> <td>Kind</td> <td>Value</td> </tr> <tr> <td>pattern</td> <td>[01]</td> </tr> </table> | Kind | Value | pattern | [01] |
| Kind | Value | | | | |
| pattern | [01] | | | | |

element Casella_Aconto_Type/ImportoMisuralInferiore

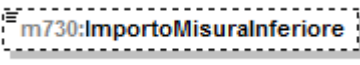
| | | | | | |
|-----------|---|------|-------|---------|----------------|
| diagram |  | | | | |
| namespace | urn:www.agenziaentrate.gov.it:specificheTecniche:sco:730 | | | | |
| type | DatoNP_Type | | | | |
| facets | <table border="1"> <tr> <td>Kind</td> <td>Value</td> </tr> <tr> <td>pattern</td> <td>[1-9]{1}[0-9]*</td> </tr> </table> | Kind | Value | pattern | [1-9]{1}[0-9]* |
| Kind | Value | | | | |
| pattern | [1-9]{1}[0-9]* | | | | |

complexType Cedolare_Secca_Type

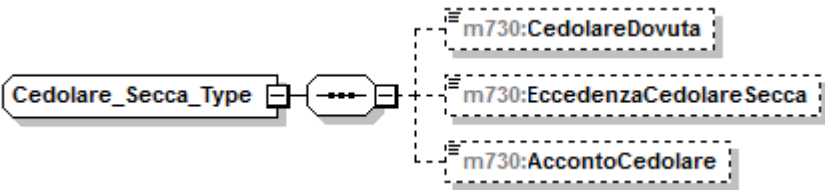
| | |
|-----------|--|
| diagram |  |
| namespace | urn:www.agenziaentrate.gov.it:specificheTecniche:sco:730 |
| children | m730:CedolareDovuta m730:EccedenzaCedolareSecca m730:AccontoCedolare |

element Cedolare_Secca_Type/CedolareDovuta

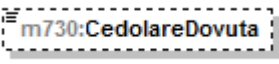
| | |
|-----------|---|
| diagram |  |
| namespace | urn:www.agenziaentrate.gov.it:specificheTecniche:sco:730 |
| type | DatoNP_Type |

| | | |
|--------|-----------------|-------------------------|
| facets | Kind pattern | Value [1-9]{1}[0-9]* |
|--------|-----------------|-------------------------|

element Cedolare_Secca_Type/EccedenzaCedolareSecca

| | | |
|-----------|--|--------------------------------|
| diagram | | |
| namespace | urn:www.agenziaentrate.gov.it:specificheTecniche:sco:730 | |
| type | DatoNU_Type | |
| facets | Kind pattern | Value (\-[1-9])?[1-9][0-9]* |

element Cedolare_Secca_Type/AcontoCedolare

| | | |
|-----------|--|-------------------------|
| diagram | | |
| namespace | urn:www.agenziaentrate.gov.it:specificheTecniche:sco:730 | |
| type | DatoNP_Type | |
| facets | Kind pattern | Value [1-9]{1}[0-9]* |

complexType Contributi_Previdenza_Complementare_Type

| | | |
|-----------|--|--|
| diagram | | |
| namespace | urn:www.agenziaentrate.gov.it:specificheTecniche:sco:730 | |
| children | m730:EsclusiDalSostituto m730:NonEsclusiDalSostituto | |

element Contributi_Previdenza_Complementare_Type/EsclusiDalSostituto

| | | |
|-----------|--|-------------------------|
| diagram | | |
| namespace | urn:www.agenziaentrate.gov.it:specificheTecniche:sco:730 | |
| type | DatoNP_Type | |
| facets | Kind pattern | Value [1-9]{1}[0-9]* |

element Contributi_Previdenza_Complementare_Type/NonEsclusiDalSostituto

| | | |
|-----------|--|--|
| diagram | | |
| namespace | urn:www.agenziaentrate.gov.it:specificheTecniche:sco:730 | |

| | |
|--------|--------------------------------------|
| type | DatoNP_Type |
| facets | Kind Value pattern [1-9]{1}[0-9]* |

complexType Contributo_Solidarieta_Type

| | |
|-----------|---|
| diagram | |
| namespace | urn:www.agenziaentrate.gov.it:specificheTecniche:sco:730 |
| children | m730:ImponibileContributo m730:ContributoDovuto m730:ContributoCertificaz |

element Contributo_Solidarieta_Type/ImponibileContributo

| | |
|-----------|--|
| diagram | |
| namespace | urn:www.agenziaentrate.gov.it:specificheTecniche:sco:730 |
| type | DatoNP_Type |
| facets | Kind Value pattern [1-9]{1}[0-9]* |

element Contributo_Solidarieta_Type/ContributoDovuto

| | |
|-----------|--|
| diagram | |
| namespace | urn:www.agenziaentrate.gov.it:specificheTecniche:sco:730 |
| type | DatoNP_Type |
| facets | Kind Value pattern [1-9]{1}[0-9]* |

element Contributo_Solidarieta_Type/ContributoCertificaz

| | |
|-----------|--|
| diagram | |
| namespace | urn:www.agenziaentrate.gov.it:specificheTecniche:sco:730 |
| type | DatoNP_Type |
| facets | Kind Value pattern [1-9]{1}[0-9]* |

complexType Cred_Imp_Estero_Type

| | |
|-----------|---|
| diagram | |
| namespace | urn:www.agenziaentrate.gov.it:specificheTecniche:sco:730 |
| children | m730:Anno m730:TotCredito m730:CreditoStato |

element Cred_Imp_Estero_Type/Anno

| | | | | | |
|-----------|---|------|-------|---------|--------------------|
| diagram | | | | | |
| namespace | urn:www.agenziaentrate.gov.it:specificheTecniche:sco:730 | | | | |
| type | DatoDA_Type | | | | |
| facets | <table border="0"> <tr> <td>Kind</td> <td>Value</td> </tr> <tr> <td>pattern</td> <td>(18 19 20)[0-9]{2}</td> </tr> </table> | Kind | Value | pattern | (18 19 20)[0-9]{2} |
| Kind | Value | | | | |
| pattern | (18 19 20)[0-9]{2} | | | | |

element Cred_Imp_Estero_Type/TotCredito

| | | | | | |
|-----------|---|------|-------|---------|----------------|
| diagram | | | | | |
| namespace | urn:www.agenziaentrate.gov.it:specificheTecniche:sco:730 | | | | |
| type | DatoNP_Type | | | | |
| facets | <table border="0"> <tr> <td>Kind</td> <td>Value</td> </tr> <tr> <td>pattern</td> <td>[1-9]{1}[0-9]*</td> </tr> </table> | Kind | Value | pattern | [1-9]{1}[0-9]* |
| Kind | Value | | | | |
| pattern | [1-9]{1}[0-9]* | | | | |

element Cred_Imp_Estero_Type/CreditoStato

| | |
|-----------|--|
| diagram | |
| namespace | urn:www.agenziaentrate.gov.it:specificheTecniche:sco:730 |
| type | m730:Credito_Stato_Type |
| children | m730:Stato m730:Credito |

complexType **Crediti_F24_Type**

| | |
|------------------|--|
| <p>diagram</p> | |
| <p>namespace</p> | <p>urn:www.agenziaentrate.gov.it:specificheTecniche:sco:730</p> |
| <p>children</p> | <p>m730:Credlrpef m730:CredlrpefDipNoSostituto m730:CodAddReg m730:CredAddReg m730:CredAddRegDipNoSostituto m730:CodiceAddCom m730:CredAddCom m730:CredAddComDipNoSostituto m730:CredCedolare m730:CredCedolareDipNoSostituito m730:CredTassSeparDipNoSostituto m730:CredProduttivitaDipNoSostituto m730:CredSolidarietaDipNoSostituto m730:Totale m730:TotaleDipNoSostituto</p> |

element **Crediti_F24_Type/Credlrpef**

| | | | | | |
|------------------|---|------|-------|---------|----------------|
| <p>diagram</p> | | | | | |
| <p>namespace</p> | <p>urn:www.agenziaentrate.gov.it:specificheTecniche:sco:730</p> | | | | |
| <p>type</p> | <p>DatoNP_Type</p> | | | | |
| <p>facets</p> | <table border="1"> <tr> <td>Kind</td> <td>Value</td> </tr> <tr> <td>pattern</td> <td>[1-9]{1}[0-9]*</td> </tr> </table> | Kind | Value | pattern | [1-9]{1}[0-9]* |
| Kind | Value | | | | |
| pattern | [1-9]{1}[0-9]* | | | | |

element Crediti_F24_Type/CredlrpefDipNoSostituto

| | | | | | |
|-----------|---|------|-------|---------|----------------|
| diagram | | | | | |
| namespace | urn:www.agenziaentrate.gov.it:specificheTecniche:sco:730 | | | | |
| type | DatoNP_Type | | | | |
| facets | <table border="0"> <tr> <td>Kind</td> <td>Value</td> </tr> <tr> <td>pattern</td> <td>[1-9]{1}[0-9]*</td> </tr> </table> | Kind | Value | pattern | [1-9]{1}[0-9]* |
| Kind | Value | | | | |
| pattern | [1-9]{1}[0-9]* | | | | |

element Crediti_F24_Type/CodAddReg

| | | | | | | | | | | | | | | | | | | | | | | | | | | | | | | | | | | | | | | | | | | | | | | | |
|-------------|---|------|-------|---------|---|-------------|---|-------------|---|-------------|---|-------------|---|-------------|---|-------------|---|-------------|---|-------------|---|-------------|---|-------------|----|-------------|----|-------------|----|-------------|----|-------------|----|-------------|----|-------------|----|-------------|----|-------------|----|-------------|----|-------------|----|-------------|----|
| diagram | | | | | | | | | | | | | | | | | | | | | | | | | | | | | | | | | | | | | | | | | | | | | | | |
| namespace | urn:www.agenziaentrate.gov.it:specificheTecniche:sco:730 | | | | | | | | | | | | | | | | | | | | | | | | | | | | | | | | | | | | | | | | | | | | | | |
| type | Codice_Regione_Type | | | | | | | | | | | | | | | | | | | | | | | | | | | | | | | | | | | | | | | | | | | | | | |
| facets | <table border="0"> <tr> <td>Kind</td> <td>Value</td> </tr> <tr> <td>pattern</td> <td>([0-9A-Z\-\-] &quot;){1}([0-9A-Z&amp;:] ' \- \., / ° √ \(\) \) À È É Ì Ò Ù Û &quot; \ \\ \ +)*</td> </tr> <tr> <td>enumeration</td> <td>1</td> </tr> <tr> <td>enumeration</td> <td>2</td> </tr> <tr> <td>enumeration</td> <td>3</td> </tr> <tr> <td>enumeration</td> <td>4</td> </tr> <tr> <td>enumeration</td> <td>5</td> </tr> <tr> <td>enumeration</td> <td>6</td> </tr> <tr> <td>enumeration</td> <td>7</td> </tr> <tr> <td>enumeration</td> <td>8</td> </tr> <tr> <td>enumeration</td> <td>9</td> </tr> <tr> <td>enumeration</td> <td>10</td> </tr> <tr> <td>enumeration</td> <td>11</td> </tr> <tr> <td>enumeration</td> <td>12</td> </tr> <tr> <td>enumeration</td> <td>13</td> </tr> <tr> <td>enumeration</td> <td>14</td> </tr> <tr> <td>enumeration</td> <td>15</td> </tr> <tr> <td>enumeration</td> <td>16</td> </tr> <tr> <td>enumeration</td> <td>17</td> </tr> <tr> <td>enumeration</td> <td>18</td> </tr> <tr> <td>enumeration</td> <td>19</td> </tr> <tr> <td>enumeration</td> <td>20</td> </tr> <tr> <td>enumeration</td> <td>21</td> </tr> </table> | Kind | Value | pattern | ([0-9A-Z\-\-] "){1}([0-9A-Z&:] ' \- \., / ° √ \(\) \) À È É Ì Ò Ù Û " \ \\ \ +)* | enumeration | 1 | enumeration | 2 | enumeration | 3 | enumeration | 4 | enumeration | 5 | enumeration | 6 | enumeration | 7 | enumeration | 8 | enumeration | 9 | enumeration | 10 | enumeration | 11 | enumeration | 12 | enumeration | 13 | enumeration | 14 | enumeration | 15 | enumeration | 16 | enumeration | 17 | enumeration | 18 | enumeration | 19 | enumeration | 20 | enumeration | 21 |
| Kind | Value | | | | | | | | | | | | | | | | | | | | | | | | | | | | | | | | | | | | | | | | | | | | | | |
| pattern | ([0-9A-Z\-\-] "){1}([0-9A-Z&:] ' \- \., / ° √ \(\) \) À È É Ì Ò Ù Û " \ \\ \ +)* | | | | | | | | | | | | | | | | | | | | | | | | | | | | | | | | | | | | | | | | | | | | | | |
| enumeration | 1 | | | | | | | | | | | | | | | | | | | | | | | | | | | | | | | | | | | | | | | | | | | | | | |
| enumeration | 2 | | | | | | | | | | | | | | | | | | | | | | | | | | | | | | | | | | | | | | | | | | | | | | |
| enumeration | 3 | | | | | | | | | | | | | | | | | | | | | | | | | | | | | | | | | | | | | | | | | | | | | | |
| enumeration | 4 | | | | | | | | | | | | | | | | | | | | | | | | | | | | | | | | | | | | | | | | | | | | | | |
| enumeration | 5 | | | | | | | | | | | | | | | | | | | | | | | | | | | | | | | | | | | | | | | | | | | | | | |
| enumeration | 6 | | | | | | | | | | | | | | | | | | | | | | | | | | | | | | | | | | | | | | | | | | | | | | |
| enumeration | 7 | | | | | | | | | | | | | | | | | | | | | | | | | | | | | | | | | | | | | | | | | | | | | | |
| enumeration | 8 | | | | | | | | | | | | | | | | | | | | | | | | | | | | | | | | | | | | | | | | | | | | | | |
| enumeration | 9 | | | | | | | | | | | | | | | | | | | | | | | | | | | | | | | | | | | | | | | | | | | | | | |
| enumeration | 10 | | | | | | | | | | | | | | | | | | | | | | | | | | | | | | | | | | | | | | | | | | | | | | |
| enumeration | 11 | | | | | | | | | | | | | | | | | | | | | | | | | | | | | | | | | | | | | | | | | | | | | | |
| enumeration | 12 | | | | | | | | | | | | | | | | | | | | | | | | | | | | | | | | | | | | | | | | | | | | | | |
| enumeration | 13 | | | | | | | | | | | | | | | | | | | | | | | | | | | | | | | | | | | | | | | | | | | | | | |
| enumeration | 14 | | | | | | | | | | | | | | | | | | | | | | | | | | | | | | | | | | | | | | | | | | | | | | |
| enumeration | 15 | | | | | | | | | | | | | | | | | | | | | | | | | | | | | | | | | | | | | | | | | | | | | | |
| enumeration | 16 | | | | | | | | | | | | | | | | | | | | | | | | | | | | | | | | | | | | | | | | | | | | | | |
| enumeration | 17 | | | | | | | | | | | | | | | | | | | | | | | | | | | | | | | | | | | | | | | | | | | | | | |
| enumeration | 18 | | | | | | | | | | | | | | | | | | | | | | | | | | | | | | | | | | | | | | | | | | | | | | |
| enumeration | 19 | | | | | | | | | | | | | | | | | | | | | | | | | | | | | | | | | | | | | | | | | | | | | | |
| enumeration | 20 | | | | | | | | | | | | | | | | | | | | | | | | | | | | | | | | | | | | | | | | | | | | | | |
| enumeration | 21 | | | | | | | | | | | | | | | | | | | | | | | | | | | | | | | | | | | | | | | | | | | | | | |

element Crediti_F24_Type/CredAddReg

| | | | | | |
|-----------|---|------|-------|---------|----------------|
| diagram | | | | | |
| namespace | urn:www.agenziaentrate.gov.it:specificheTecniche:sco:730 | | | | |
| type | DatoNP_Type | | | | |
| facets | <table border="0"> <tr> <td>Kind</td> <td>Value</td> </tr> <tr> <td>pattern</td> <td>[1-9]{1}[0-9]*</td> </tr> </table> | Kind | Value | pattern | [1-9]{1}[0-9]* |
| Kind | Value | | | | |
| pattern | [1-9]{1}[0-9]* | | | | |

element Crediti_F24_Type/CredAddRegDipNoSostituto

| | |
|-----------|--|
| diagram | |
| namespace | urn:www.agenziaentrate.gov.it:specificheTecniche:sco:730 |

| | |
|--------|--------------------------------------|
| type | DatoNP_Type |
| facets | Kind Value pattern [1-9]{1}[0-9]* |

element Crediti_F24_Type/CodiceAddCom

| | |
|-----------|--|
| diagram | |
| namespace | urn:www.agenziaentrate.gov.it:specificheTecniche:sco:730 |
| type | DatoAN_Type |
| facets | Kind Value pattern (([0-9A-Z\-_]"){1}([0-9A-Z&:] \- \., / \^\(\ \)\À È É Ì Ò Ù Û " \ \\ / +)* |

element Crediti_F24_Type/CredAddCom

| | |
|-----------|--|
| diagram | |
| namespace | urn:www.agenziaentrate.gov.it:specificheTecniche:sco:730 |
| type | DatoNP_Type |
| facets | Kind Value pattern [1-9]{1}[0-9]* |

element Crediti_F24_Type/CredAddComDipNoSostituto

| | |
|-----------|--|
| diagram | |
| namespace | urn:www.agenziaentrate.gov.it:specificheTecniche:sco:730 |
| type | DatoNP_Type |
| facets | Kind Value pattern [1-9]{1}[0-9]* |

element Crediti_F24_Type/CredCedolare

| | |
|-----------|--|
| diagram | |
| namespace | urn:www.agenziaentrate.gov.it:specificheTecniche:sco:730 |
| type | DatoNP_Type |
| facets | Kind Value pattern [1-9]{1}[0-9]* |

element Crediti_F24_Type/CredCedolareDipNoSostituto

| | |
|-----------|--|
| diagram | |
| namespace | urn:www.agenziaentrate.gov.it:specificheTecniche:sco:730 |

| | |
|--------|--------------------------------------|
| type | DatoNP_Type |
| facets | Kind Value pattern [1-9]{1}[0-9]* |

element Crediti_F24_Type/CredTassSeparDipNoSostituto

| | |
|-----------|--|
| diagram | |
| namespace | urn:www.agenziaentrate.gov.it:specificheTecniche:sco:730 |
| type | DatoNP_Type |
| facets | Kind Value pattern [1-9]{1}[0-9]* |

element Crediti_F24_Type/CredProduttivitaDipNoSostituto

| | |
|-----------|--|
| diagram | |
| namespace | urn:www.agenziaentrate.gov.it:specificheTecniche:sco:730 |
| type | DatoNP_Type |
| facets | Kind Value pattern [1-9]{1}[0-9]* |

element Crediti_F24_Type/CredSolidarietaDipNoSostituto

| | |
|-----------|--|
| diagram | |
| namespace | urn:www.agenziaentrate.gov.it:specificheTecniche:sco:730 |
| type | DatoNP_Type |
| facets | Kind Value pattern [1-9]{1}[0-9]* |

element Crediti_F24_Type/Totale

| | |
|-----------|--|
| diagram | |
| namespace | urn:www.agenziaentrate.gov.it:specificheTecniche:sco:730 |
| type | DatoNP_Type |
| facets | Kind Value pattern [1-9]{1}[0-9]* |

element Crediti_F24_Type/TotaleDipNoSostituto

| | |
|-----------|--|
| diagram | |
| namespace | urn:www.agenziaentrate.gov.it:specificheTecniche:sco:730 |

| | |
|--------|--------------------------------------|
| type | DatoNP_Type |
| facets | Kind Value pattern [1-9]{1}[0-9]* |

complexType **Crediti_Imposta**

| | |
|-----------|--|
| diagram | |
| namespace | urn:www.agenziaentrate.gov.it:specificheTecniche:sco:730 |
| children | m730:PrimoModulo m730:Modulo |

element **Crediti_Imposta/PrimoModulo**

| | |
|-----------|---|
| diagram | |
| namespace | urn:www.agenziaentrate.gov.it:specificheTecniche:sco:730 |
| type | m730:Primo_Modulo_Crediti_Imposta_Type |
| children | m730:CreditoImpostaFabbricati m730:CreditoImpostaFondiPensione m730:CreditoImpostaRedditiEsteri m730:CreditoPrimaCasaSismaAbruzzo m730:CreditoAltriSismaAbruzzo m730:CreditoIncrementoOccupazione m730:CreditoImpostaMediazioni m730:CreditoErogazioniCultura |

element **Crediti_Imposta/Modulo**

| | |
|-----------|---|
| diagram | |
| namespace | urn:www.agenziaentrate.gov.it:specificheTecniche:sco:730 |
| type | m730:Modulo_Crediti_Imposta_Type |
| children | m730:CreditiImpostaFondiPensione m730:CreditiImpostaRedditiEsteri m730:CreditoPrimaCasaSismaAbruzzo m730:CreditoAltriSismaAbruzzo |

complexType **Crediti_Imposta_Altri_Sisma_Abruzzo_Type**

| | |
|-----------|---|
| diagram | |
| namespace | urn:www.agenziaentrate.gov.it:specificheTecniche:sco:730 |
| children | m730:Impresa_Professione m730:CreditoImmobileSismaAbruzzo m730:Rateazione |

element **Crediti_Imposta_Altri_Sisma_Abruzzo_Type/Impresa_Professione**

| | | | | | |
|-----------|---|------|-------|---------|------|
| diagram | | | | | |
| namespace | urn:www.agenziaentrate.gov.it:specificheTecniche:sco:730 | | | | |
| type | DatoCB_Type | | | | |
| facets | <table border="1"> <tr> <td>Kind</td> <td>Value</td> </tr> <tr> <td>pattern</td> <td>[01]</td> </tr> </table> | Kind | Value | pattern | [01] |
| Kind | Value | | | | |
| pattern | [01] | | | | |

element **Crediti_Imposta_Altri_Sisma_Abruzzo_Type/CreditoImmobilSismaAbruzzo**

| | |
|-----------|---|
| diagram | |
| namespace | urn:www.agenziaentrate.gov.it:specificheTecniche:sco:730 |
| type | m730:Credito_Immobil_Sisma_Abruzzo_Type |
| children | m730:CodiceFiscale m730:NumeroRata m730:TotaleCredito |

element **Crediti_Imposta_Altri_Sisma_Abruzzo_Type/Rateazione**

| | | | | | | | | | |
|-------------|--|------|-------|---------|----------------|-------------|---|-------------|----|
| diagram | | | | | | | | | |
| namespace | urn:www.agenziaentrate.gov.it:specificheTecniche:sco:730 | | | | | | | | |
| type | m730:Numero_Rate5o10_Type | | | | | | | | |
| facets | <table border="0"> <tr> <td>Kind</td> <td>Value</td> </tr> <tr> <td>pattern</td> <td>[1-9]{1}[0-9]*</td> </tr> <tr> <td>enumeration</td> <td>5</td> </tr> <tr> <td>enumeration</td> <td>10</td> </tr> </table> | Kind | Value | pattern | [1-9]{1}[0-9]* | enumeration | 5 | enumeration | 10 |
| Kind | Value | | | | | | | | |
| pattern | [1-9]{1}[0-9]* | | | | | | | | |
| enumeration | 5 | | | | | | | | |
| enumeration | 10 | | | | | | | | |

complexType **Crediti_Imposta_Fabbicati_Type**

| | |
|-----------|--|
| diagram | |
| namespace | urn:www.agenziaentrate.gov.it:specificheTecniche:sco:730 |
| children | m730:ResiduoFabbicati m730:CanoniLocazioneNonPercepiti |

element **Crediti_Imposta_Fabbicati_Type/ResiduoFabbicati**

| | |
|-----------|---|
| diagram | |
| namespace | urn:www.agenziaentrate.gov.it:specificheTecniche:sco:730 |
| type | m730:Residuo_Credito_Compens_Annolmposta_Type |

| | |
|----------|--|
| children | m730:CreditoAnno m730:DiCuiCompensatoF24 |
|----------|--|

element Crediti_Imposta_Fabbicati_Type/CanoniLocazioneNonPercepti

| | |
|-----------|--|
| diagram | |
| namespace | urn:www.agenziaentrate.gov.it:specificheTecniche:sco:730 |
| type | DatoNP_Type |
| facets | Kind Value pattern [1-9]{1}[0-9]* |

complexType Crediti_Imposta_Fondi_Pensione_Type

| | |
|-----------|--|
| diagram | |
| namespace | urn:www.agenziaentrate.gov.it:specificheTecniche:sco:730 |
| children | m730:AnnoAnticipazione m730:Reintegro m730:SommaReintegrata m730:CreditoAnno |

element Crediti_Imposta_Fondi_Pensione_Type/AnnoAnticipazione

| | |
|-----------|--|
| diagram | |
| namespace | urn:www.agenziaentrate.gov.it:specificheTecniche:sco:730 |
| type | m730:Anno_Anticipazione_Fondo_Pensione_Type |
| facets | Kind Value pattern [1-9]{1}[0-9]* enumeration 2007 enumeration 2008 enumeration 2009 enumeration 2010 enumeration 2011 enumeration 2012 enumeration 2013 enumeration 2014 |

element Crediti_Imposta_Fondi_Pensione_Type/Reintegro

| | |
|-----------|--|
| diagram | |
| namespace | urn:www.agenziaentrate.gov.it:specificheTecniche:sco:730 |
| type | m730:Reintegro_Totale_Parziale_Type |

| | | |
|--------|-------------|-------|
| facets | Kind | Value |
| | pattern | [1-9] |
| | enumeration | 1 |
| | enumeration | 2 |

element Crediti_Imposta_Fondi_Pensione_Type/SommaReintegrata

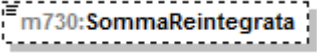
| | |
|-----------|---|
| diagram |  |
| namespace | urn:www.agenziaentrate.gov.it:specificheTecniche:sco:730 |
| type | DatoNP_Type |
| facets | Kind Value pattern [1-9]{1}[0-9]* |

element Crediti_Imposta_Fondi_Pensione_Type/CreditoAnno

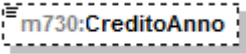
| | |
|-----------|---|
| diagram |  |
| namespace | urn:www.agenziaentrate.gov.it:specificheTecniche:sco:730 |
| type | DatoNP_Type |
| facets | Kind Value pattern [1-9]{1}[0-9]* |

complexType Crediti_Imposta_Redditi_Esteri_Type

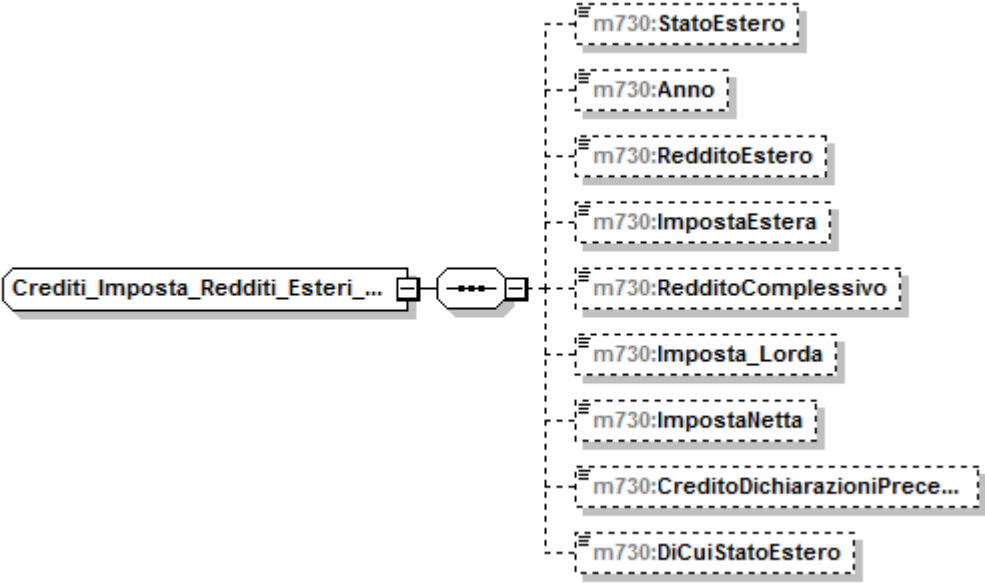
| | |
|-----------|---|
| diagram |  |
| namespace | urn:www.agenziaentrate.gov.it:specificheTecniche:sco:730 |
| children | m730:StatoEstero m730:Anno m730:RedditoEstero m730:ImpostaEstera m730:RedditoComplessivo m730:Imposta_Lorda m730:ImpostaNetta m730:CreditoDichiarazioniPrecedenti m730:DiCuiStatoEstero |

element Crediti_Imposta_Redditi_Esteri_Type/StatoEstero

| | |
|-----------|--|
| diagram |  |
| namespace | urn:www.agenziaentrate.gov.it:specificheTecniche:sco:730 |
| type | DatoAN_Type |
| facets | Kind Value pattern ([0-9A-Z-] \"){1}([0-9A-Z&:] \- \., / \^ \(\) À É È Ì Ò Ù Ü " \N \\ +)* |

element Crediti_Imposta_Redditi_Esteri_Type/Anno

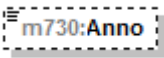
| | |
|-----------|---|
| diagram |  |
| namespace | urn:www.agenziaentrate.gov.it:specificheTecniche:sco:730 |
| type | restriction of DatoDA_Type |
| facets | Kind Value pattern (18 19 20)[0-9]{2} |

element Crediti_Imposta_Redditi_Esteri_Type/RedditoEstero

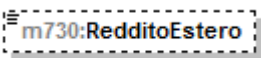
| | |
|-----------|---|
| diagram |  |
| namespace | urn:www.agenziaentrate.gov.it:specificheTecniche:sco:730 |
| type | DatoNP_Type |
| facets | Kind Value pattern [1-9]{1}[0-9]* |

element Crediti_Imposta_Redditi_Esteri_Type/ImpostaEsteri

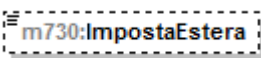
| | |
|-----------|---|
| diagram |  |
| namespace | urn:www.agenziaentrate.gov.it:specificheTecniche:sco:730 |
| type | DatoNP_Type |
| facets | Kind Value pattern [1-9]{1}[0-9]* |

element Crediti_Imposta_Redditi_Esteri_Type/RedditoComplessivo

| | |
|-----------|---|
| diagram |  |
| namespace | urn:www.agenziaentrate.gov.it:specificheTecniche:sco:730 |
| type | DatoNP_Type |
| facets | Kind Value pattern [1-9]{1}[0-9]* |

element Crediti Imposta Redditi Esteri Type/Imposta_Lorda

| | |
|-----------|--|
| diagram | |
| namespace | urn:www.agenziaentrate.gov.it:specificheTecniche:sco:730 |
| type | DatoNP_Type |
| facets | Kind Value pattern [1-9]{1}[0-9]* |

element Crediti Imposta Redditi Esteri Type/ImpostaNetta

| | |
|-----------|--|
| diagram | |
| namespace | urn:www.agenziaentrate.gov.it:specificheTecniche:sco:730 |
| type | DatoNP_Type |
| facets | Kind Value pattern [1-9]{1}[0-9]* |

element Crediti Imposta Redditi Esteri Type/CreditoDichiarazioniPrecedenti

| | |
|-----------|--|
| diagram | |
| namespace | urn:www.agenziaentrate.gov.it:specificheTecniche:sco:730 |
| type | DatoNP_Type |
| facets | Kind Value pattern [1-9]{1}[0-9]* |

element Crediti Imposta Redditi Esteri Type/DiCuiStatoEstero

| | |
|-----------|--|
| diagram | |
| namespace | urn:www.agenziaentrate.gov.it:specificheTecniche:sco:730 |
| type | DatoNP_Type |
| facets | Kind Value pattern [1-9]{1}[0-9]* |

complexType Credito_Immibile_Sisma_Abruzzo_Type

| | |
|-----------|---|
| diagram | |
| namespace | urn:www.agenziaentrate.gov.it:specificheTecniche:sco:730 |
| children | m730:CodiceFiscale m730:NumeroRata m730:TotaleCredito |

element Credito_Immobile_Sisma_Abruzzo_Type/CodiceFiscale

| | | | | | |
|-----------|---|------|-------|---------|--|
| diagram | | | | | |
| namespace | urn:www.agenziaentrate.gov.it:specificheTecniche:sco:730 | | | | |
| type | DatoCF_Type | | | | |
| facets | <table border="0"> <tr> <td>Kind</td> <td>Value</td> </tr> <tr> <td>pattern</td> <td>[0-9]{11}[A-Z]{6}[0-9LMNPQRSTUUV]{2}[A-Z]{1}[0-9LMNPQRSTUUV]{2}[A-Z]{1}[0-9LMNPQRSTUUV]{3}[A-Z]{1}</td> </tr> </table> | Kind | Value | pattern | [0-9]{11}[A-Z]{6}[0-9LMNPQRSTUUV]{2}[A-Z]{1}[0-9LMNPQRSTUUV]{2}[A-Z]{1}[0-9LMNPQRSTUUV]{3}[A-Z]{1} |
| Kind | Value | | | | |
| pattern | [0-9]{11}[A-Z]{6}[0-9LMNPQRSTUUV]{2}[A-Z]{1}[0-9LMNPQRSTUUV]{2}[A-Z]{1}[0-9LMNPQRSTUUV]{3}[A-Z]{1} | | | | |

element Credito_Immobile_Sisma_Abruzzo_Type/NumeroRata

| | | | | | | | | | | | | | | | | | |
|-------------|--|------|-------|---------|-------|-------------|---|-------------|---|-------------|---|-------------|---|-------------|---|-------------|---|
| diagram | | | | | | | | | | | | | | | | | |
| namespace | urn:www.agenziaentrate.gov.it:specificheTecniche:sco:730 | | | | | | | | | | | | | | | | |
| type | m730:Numero_RateDa1A6_Type | | | | | | | | | | | | | | | | |
| facets | <table border="0"> <tr> <td>Kind</td> <td>Value</td> </tr> <tr> <td>pattern</td> <td>[1-9]</td> </tr> <tr> <td>enumeration</td> <td>1</td> </tr> <tr> <td>enumeration</td> <td>2</td> </tr> <tr> <td>enumeration</td> <td>3</td> </tr> <tr> <td>enumeration</td> <td>4</td> </tr> <tr> <td>enumeration</td> <td>5</td> </tr> <tr> <td>enumeration</td> <td>6</td> </tr> </table> | Kind | Value | pattern | [1-9] | enumeration | 1 | enumeration | 2 | enumeration | 3 | enumeration | 4 | enumeration | 5 | enumeration | 6 |
| Kind | Value | | | | | | | | | | | | | | | | |
| pattern | [1-9] | | | | | | | | | | | | | | | | |
| enumeration | 1 | | | | | | | | | | | | | | | | |
| enumeration | 2 | | | | | | | | | | | | | | | | |
| enumeration | 3 | | | | | | | | | | | | | | | | |
| enumeration | 4 | | | | | | | | | | | | | | | | |
| enumeration | 5 | | | | | | | | | | | | | | | | |
| enumeration | 6 | | | | | | | | | | | | | | | | |

element Credito_Immobile_Sisma_Abruzzo_Type/TotaleCredito

| | | | | | |
|-----------|---|------|-------|---------|----------------|
| diagram | | | | | |
| namespace | urn:www.agenziaentrate.gov.it:specificheTecniche:sco:730 | | | | |
| type | DatoNP_Type | | | | |
| facets | <table border="0"> <tr> <td>Kind</td> <td>Value</td> </tr> <tr> <td>pattern</td> <td>[1-9]{1}[0-9]*</td> </tr> </table> | Kind | Value | pattern | [1-9]{1}[0-9]* |
| Kind | Value | | | | |
| pattern | [1-9]{1}[0-9]* | | | | |

complexType Credito_Stato_Type

| | |
|-----------|--|
| diagram | |
| namespace | urn:www.agenziaentrate.gov.it:specificheTecniche:sco:730 |
| children | m730:Stato m730:Credito |

element Credito_Stato_Type/Stato

| | |
|-----------|---|
| diagram | |
| namespace | urn:www.agenziaentrate.gov.it:specificheTecniche:sco:730 |
| type | DatoAN_Type |
| facets | Kind Value pattern ([0-9A-Z-] \"){1}([0-9A-Z&:] ' \- \., / ° ^\(\)\ À É È Ì Ò Ù Ü " \ \\ / +)* |

element Credito_Stato_Type/Credito

| | |
|-----------|--|
| diagram | |
| namespace | urn:www.agenziaentrate.gov.it:specificheTecniche:sco:730 |
| type | DatoNP_Type |
| facets | Kind Value pattern [1-9]{1}[0-9]* |

complexType Credito_Type

| | |
|-----------|--|
| diagram | |
| namespace | urn:www.agenziaentrate.gov.it:specificheTecniche:sco:730 |
| children | m730:NonRimborsabile m730:Credito m730:CreditoF24 m730:CreditoRimborso |

element Credito_Type/NonRimborsabile

| | |
|-----------|--|
| diagram | |
| namespace | urn:www.agenziaentrate.gov.it:specificheTecniche:sco:730 |
| type | DatoNP_Type |
| facets | Kind Value pattern [1-9]{1}[0-9]* |

element Credito_Type/Credito

| | |
|-----------|--|
| diagram | |
| namespace | urn:www.agenziaentrate.gov.it:specificheTecniche:sco:730 |

| | |
|--------|--------------------------------------|
| type | DatoNP_Type |
| facets | Kind Value pattern [1-9]{1}[0-9]* |

element Credito_Type/CreditoF24

| | |
|-----------|--|
| diagram | |
| namespace | urn:www.agenziaentrate.gov.it:specificheTecniche:sco:730 |
| type | DatoNP_Type |
| facets | Kind Value pattern [1-9]{1}[0-9]* |

element Credito_Type/CreditoRimborso

| | |
|-----------|--|
| diagram | |
| namespace | urn:www.agenziaentrate.gov.it:specificheTecniche:sco:730 |
| type | DatoNP_Type |
| facets | Kind Value pattern [1-9]{1}[0-9]* |

complexType Dati_730Integrativo_Type

| | |
|-----------|--|
| diagram | |
| namespace | urn:www.agenziaentrate.gov.it:specificheTecniche:sco:730 |
| children | m730:Rimborso m730:Credito |

element Dati_730Integrativo_Type/Rimborso

| | |
|-----------|--|
| diagram | |
| namespace | urn:www.agenziaentrate.gov.it:specificheTecniche:sco:730 |
| type | m730:Elemento_Integrativo_Type |

| | |
|----------|--|
| children | m730:Irpef m730:AddizionaleRegionaleIrpef m730:AddComunaleIrpef m730:CedolareSecca |
|----------|--|

element Dati_730Integrativo_Type/Credito

| | |
|-----------|--|
| diagram | |
| namespace | urn:www.agenziaentrate.gov.it:specificheTecniche:sco:730 |
| type | m730:Elemento Integrativo Type |
| children | m730:Irpef m730:AddizionaleRegionaleIrpef m730:AddComunaleIrpef m730:CedolareSecca |

complexType Dati_Altre_Detrazioni_Modulo_Type

| | |
|-----------|--|
| diagram | |
| namespace | urn:www.agenziaentrate.gov.it:specificheTecniche:sco:730 |
| children | m730:AltreDetrazioni |

element Dati_Altre_Detrazioni_Modulo_Type/AltreDetrazioni

| | |
|-----------|--|
| diagram | |
| namespace | urn:www.agenziaentrate.gov.it:specificheTecniche:sco:730 |
| type | m730:Altre Detrazioni Type |
| children | m730:Codice m730:Importo |

complexType **Dati_Altre_Detrazioni_Type**

| | |
|-----------|---|
| diagram | |
| namespace | urn:www.agenziaentrate.gov.it:specificheTecniche:sco:730 |
| children | m730:SpeseCaniGuida m730:AffittoTerreniAgricoliGiovani m730:AltreDetrazioni |

element **Dati_Altre_Detrazioni_Type/SpeseCaniGuida**

| diagram | | | | | |
|-----------|---|------|-------|---------|------|
| namespace | urn:www.agenziaentrate.gov.it:specificheTecniche:sco:730 | | | | |
| type | DatoCB_Type | | | | |
| facets | <table border="1"> <thead> <tr> <th>Kind</th> <th>Value</th> </tr> </thead> <tbody> <tr> <td>pattern</td> <td>[01]</td> </tr> </tbody> </table> | Kind | Value | pattern | [01] |
| Kind | Value | | | | |
| pattern | [01] | | | | |

element **Dati_Altre_Detrazioni_Type/AffittoTerreniAgricoliGiovani**

| diagram | | | | | |
|-----------|---|------|-------|---------|----------------|
| namespace | urn:www.agenziaentrate.gov.it:specificheTecniche:sco:730 | | | | |
| type | DatoNP_Type | | | | |
| facets | <table border="1"> <thead> <tr> <th>Kind</th> <th>Value</th> </tr> </thead> <tbody> <tr> <td>pattern</td> <td>[1-9]{1}[0-9]*</td> </tr> </tbody> </table> | Kind | Value | pattern | [1-9]{1}[0-9]* |
| Kind | Value | | | | |
| pattern | [1-9]{1}[0-9]* | | | | |

element **Dati_Altre_Detrazioni_Type/AltreDetrazioni**

| | |
|-----------|--|
| diagram | |
| namespace | urn:www.agenziaentrate.gov.it:specificheTecniche:sco:730 |
| type | m730:Altre_Detrazioni_Type |
| children | m730:Codice m730:Importo |

complexType **Dati_Catastali_Recupero_Patrimonio_Edilizio_Type**

| | |
|-----------|--|
| diagram | |
| namespace | urn:www.agenziaentrate.gov.it:specificheTecniche:sco:730 |
| children | m730:NOrdImmobile m730:Condominio m730:CodiceComune m730:TerreniUrbano m730:SezioneUrbanaComuneCatastale m730:Foglio m730:Particella m730:Subalterno |

element **Dati_Catastali_Recupero_Patrimonio_Edilizio_Type/NOrdImmobile**

| diagram | | | | | |
|-----------|---|------|-------|---------|----------------|
| namespace | urn:www.agenziaentrate.gov.it:specificheTecniche:sco:730 | | | | |
| type | DatoNP_Type | | | | |
| facets | <table border="1"> <tr> <th>Kind</th> <th>Value</th> </tr> <tr> <td>pattern</td> <td>[1-9]{1}[0-9]*</td> </tr> </table> | Kind | Value | pattern | [1-9]{1}[0-9]* |
| Kind | Value | | | | |
| pattern | [1-9]{1}[0-9]* | | | | |

element **Dati_Catastali_Recupero_Patrimonio_Edilizio_Type/Condominio**

| diagram | | | | | |
|-----------|---|------|-------|---------|------|
| namespace | urn:www.agenziaentrate.gov.it:specificheTecniche:sco:730 | | | | |
| type | DatoCB_Type | | | | |
| facets | <table border="1"> <tr> <th>Kind</th> <th>Value</th> </tr> <tr> <td>pattern</td> <td>[01]</td> </tr> </table> | Kind | Value | pattern | [01] |
| Kind | Value | | | | |
| pattern | [01] | | | | |

element **Dati_Catastali_Recupero_Patrimonio_Edilizio_Type/CodiceComune**

| diagram | | | | | |
|-----------|--|------|-------|---------|---|
| namespace | urn:www.agenziaentrate.gov.it:specificheTecniche:sco:730 | | | | |
| type | DatoAN_Type | | | | |
| facets | <table border="1"> <tr> <th>Kind</th> <th>Value</th> </tr> <tr> <td>pattern</td> <td>([0-9A-Z\-_]&quot;){1}([0-9A-Z&amp;:] \- \., / \° \^ \(\) \À \É \È \Ì \Ò \Ù \Û &quot; \\ \ +)*</td> </tr> </table> | Kind | Value | pattern | ([0-9A-Z\-_]"){1}([0-9A-Z&:] \- \., / \° \^ \(\) \À \É \È \Ì \Ò \Ù \Û " \\ \ +)* |
| Kind | Value | | | | |
| pattern | ([0-9A-Z\-_]"){1}([0-9A-Z&:] \- \., / \° \^ \(\) \À \É \È \Ì \Ò \Ù \Û " \\ \ +)* | | | | |

element Dati_Catastali_Recupero_Patrimonio_Edilizio_Type/TerreniUrbano

| | | | | | | | | | |
|-------------|--|------|-------|---------|---|-------------|---|-------------|---|
| diagram | | | | | | | | | |
| namespace | urn:www.agenziaentrate.gov.it:specificheTecniche:sco:730 | | | | | | | | |
| type | m730:Terreni_Urbano_Type | | | | | | | | |
| facets | <table border="0"> <tr> <td>Kind</td> <td>Value</td> </tr> <tr> <td>pattern</td> <td>(([0-9A-Z-])&quot;){1}([0-9A-Z&amp;:] ' \-\. , / ^ \^\(\\) À È É Ì Ò Ù Û &quot; \\ / +)*</td> </tr> <tr> <td>enumeration</td> <td>T</td> </tr> <tr> <td>enumeration</td> <td>U</td> </tr> </table> | Kind | Value | pattern | (([0-9A-Z-])"){1}([0-9A-Z&:] ' \-\. , / ^ \^\(\\) À È É Ì Ò Ù Û " \\ / +)* | enumeration | T | enumeration | U |
| Kind | Value | | | | | | | | |
| pattern | (([0-9A-Z-])"){1}([0-9A-Z&:] ' \-\. , / ^ \^\(\\) À È É Ì Ò Ù Û " \\ / +)* | | | | | | | | |
| enumeration | T | | | | | | | | |
| enumeration | U | | | | | | | | |

element Dati_Catastali_Recupero_Patrimonio_Edilizio_Type/SezioneUrbanaComuneCatastale

| | | | | | |
|-----------|--|------|-------|---------|---|
| diagram | | | | | |
| namespace | urn:www.agenziaentrate.gov.it:specificheTecniche:sco:730 | | | | |
| type | DatoAN_Type | | | | |
| facets | <table border="0"> <tr> <td>Kind</td> <td>Value</td> </tr> <tr> <td>pattern</td> <td>(([0-9A-Z-])&quot;){1}([0-9A-Z&amp;:] ' \-\. , / ^ \^\(\\) À È É Ì Ò Ù Û &quot; \\ / +)*</td> </tr> </table> | Kind | Value | pattern | (([0-9A-Z-])"){1}([0-9A-Z&:] ' \-\. , / ^ \^\(\\) À È É Ì Ò Ù Û " \\ / +)* |
| Kind | Value | | | | |
| pattern | (([0-9A-Z-])"){1}([0-9A-Z&:] ' \-\. , / ^ \^\(\\) À È É Ì Ò Ù Û " \\ / +)* | | | | |

element Dati_Catastali_Recupero_Patrimonio_Edilizio_Type/Foglio

| | | | | | |
|-----------|--|------|-------|---------|---|
| diagram | | | | | |
| namespace | urn:www.agenziaentrate.gov.it:specificheTecniche:sco:730 | | | | |
| type | DatoAN_Type | | | | |
| facets | <table border="0"> <tr> <td>Kind</td> <td>Value</td> </tr> <tr> <td>pattern</td> <td>(([0-9A-Z-])&quot;){1}([0-9A-Z&amp;:] ' \-\. , / ^ \^\(\\) À È É Ì Ò Ù Û &quot; \\ / +)*</td> </tr> </table> | Kind | Value | pattern | (([0-9A-Z-])"){1}([0-9A-Z&:] ' \-\. , / ^ \^\(\\) À È É Ì Ò Ù Û " \\ / +)* |
| Kind | Value | | | | |
| pattern | (([0-9A-Z-])"){1}([0-9A-Z&:] ' \-\. , / ^ \^\(\\) À È É Ì Ò Ù Û " \\ / +)* | | | | |

element Dati_Catastali_Recupero_Patrimonio_Edilizio_Type/Particella

| | |
|-----------|---|
| diagram | |
| namespace | urn:www.agenziaentrate.gov.it:specificheTecniche:sco:730 |
| children | m730:Numeratore m730:Denominatore |

element Dati_Catastali_Recupero_Patrimonio_Edilizio_Type/Particella/Numeratore

| | |
|-----------|--|
| diagram | |
| namespace | urn:www.agenziaentrate.gov.it:specificheTecniche:sco:730 |
| type | DatoAN_Type |

| | |
|--------|---|
| facets | Kind Value pattern ([0-9A-Z-]*)"){1}([0-9A-Z&:] ' \"- \\. , / ^\\(\\ \\) À É Ê Ì Ò Ù Û " \\ \\ \\ +)* |
|--------|---|

element Dati_Catastali_Recupero_Patrimonio_Edilizio_Type/Particella/Denominatore

| | |
|-----------|---|
| diagram | |
| namespace | urn:www.agenziaentrate.gov.it:specificheTecniche:sco:730 |
| type | DatoAN_Type |
| facets | Kind Value pattern ([0-9A-Z-]*)"){1}([0-9A-Z&:] ' \"- \\. , / ^\\(\\ \\) À É Ê Ì Ò Ù Û " \\ \\ \\ +)* |

element Dati_Catastali_Recupero_Patrimonio_Edilizio_Type/Subalterno

| | |
|-----------|---|
| diagram | |
| namespace | urn:www.agenziaentrate.gov.it:specificheTecniche:sco:730 |
| type | DatoAN_Type |
| facets | Kind Value pattern ([0-9A-Z-]*)"){1}([0-9A-Z&:] ' \"- \\. , / ^\\(\\ \\) À É Ê Ì Ò Ù Û " \\ \\ \\ +)* |

complexType Dati_Coniuge_Type

| | |
|-----------|--|
| diagram | |
| namespace | urn:www.agenziaentrate.gov.it:specificheTecniche:sco:730 |
| children | m730:Tipo m730:CodiceFiscale m730:Mesi |

element Dati_Coniuge_Type/Tipo

| | |
|-----------|--|
| diagram | |
| namespace | urn:www.agenziaentrate.gov.it:specificheTecniche:sco:730 |
| type | DatoCB_Type |
| facets | Kind Value pattern [01] |

element Dati_Coniuge_Type/CodiceFiscale

| | |
|---------|--|
| diagram | |
|---------|--|

| namespace | urn:www.agenziaentrate.gov.it:specificheTecniche:sco:730 | | | | |
|-----------|---|------|-------|---------|--|
| type | DatoCF_Type | | | | |
| facets | <table border="1"> <thead> <tr> <th>Kind</th> <th>Value</th> </tr> </thead> <tbody> <tr> <td>pattern</td> <td>[0-9]{1}[A-Z]{6}[0-9LMNPQRSTUVWXYZ]{2}[A-Z]{1}[0-9LMNPQRSTUVWXYZ]{2}[A-Z]{1}[0-9LMNPQRSTUVWXYZ]{3}[A-Z]{1}</td> </tr> </tbody> </table> | Kind | Value | pattern | [0-9]{1}[A-Z]{6}[0-9LMNPQRSTUVWXYZ]{2}[A-Z]{1}[0-9LMNPQRSTUVWXYZ]{2}[A-Z]{1}[0-9LMNPQRSTUVWXYZ]{3}[A-Z]{1} |
| Kind | Value | | | | |
| pattern | [0-9]{1}[A-Z]{6}[0-9LMNPQRSTUVWXYZ]{2}[A-Z]{1}[0-9LMNPQRSTUVWXYZ]{2}[A-Z]{1}[0-9LMNPQRSTUVWXYZ]{3}[A-Z]{1} | | | | |

element **Dati_Coniuge_Type/Mesi**

| diagram | | | | | | | | | | | | | | | | | | | | | | | | | | | | | |
|-------------|--|------|-------|---------|----------------|-------------|---|-------------|---|-------------|---|-------------|---|-------------|---|-------------|---|-------------|---|-------------|---|-------------|---|-------------|----|-------------|----|-------------|----|
| namespace | urn:www.agenziaentrate.gov.it:specificheTecniche:sco:730 | | | | | | | | | | | | | | | | | | | | | | | | | | | | |
| type | m730:Mesi_Type | | | | | | | | | | | | | | | | | | | | | | | | | | | | |
| facets | <table border="1"> <thead> <tr> <th>Kind</th> <th>Value</th> </tr> </thead> <tbody> <tr> <td>pattern</td> <td>[1-9]{1}[0-9]*</td> </tr> <tr> <td>enumeration</td> <td>1</td> </tr> <tr> <td>enumeration</td> <td>2</td> </tr> <tr> <td>enumeration</td> <td>3</td> </tr> <tr> <td>enumeration</td> <td>4</td> </tr> <tr> <td>enumeration</td> <td>5</td> </tr> <tr> <td>enumeration</td> <td>6</td> </tr> <tr> <td>enumeration</td> <td>7</td> </tr> <tr> <td>enumeration</td> <td>8</td> </tr> <tr> <td>enumeration</td> <td>9</td> </tr> <tr> <td>enumeration</td> <td>10</td> </tr> <tr> <td>enumeration</td> <td>11</td> </tr> <tr> <td>enumeration</td> <td>12</td> </tr> </tbody> </table> | Kind | Value | pattern | [1-9]{1}[0-9]* | enumeration | 1 | enumeration | 2 | enumeration | 3 | enumeration | 4 | enumeration | 5 | enumeration | 6 | enumeration | 7 | enumeration | 8 | enumeration | 9 | enumeration | 10 | enumeration | 11 | enumeration | 12 |
| Kind | Value | | | | | | | | | | | | | | | | | | | | | | | | | | | | |
| pattern | [1-9]{1}[0-9]* | | | | | | | | | | | | | | | | | | | | | | | | | | | | |
| enumeration | 1 | | | | | | | | | | | | | | | | | | | | | | | | | | | | |
| enumeration | 2 | | | | | | | | | | | | | | | | | | | | | | | | | | | | |
| enumeration | 3 | | | | | | | | | | | | | | | | | | | | | | | | | | | | |
| enumeration | 4 | | | | | | | | | | | | | | | | | | | | | | | | | | | | |
| enumeration | 5 | | | | | | | | | | | | | | | | | | | | | | | | | | | | |
| enumeration | 6 | | | | | | | | | | | | | | | | | | | | | | | | | | | | |
| enumeration | 7 | | | | | | | | | | | | | | | | | | | | | | | | | | | | |
| enumeration | 8 | | | | | | | | | | | | | | | | | | | | | | | | | | | | |
| enumeration | 9 | | | | | | | | | | | | | | | | | | | | | | | | | | | | |
| enumeration | 10 | | | | | | | | | | | | | | | | | | | | | | | | | | | | |
| enumeration | 11 | | | | | | | | | | | | | | | | | | | | | | | | | | | | |
| enumeration | 12 | | | | | | | | | | | | | | | | | | | | | | | | | | | | |

complexType **Dati_Contabili_Type**

| | |
|-----------|--|
| diagram | |
| namespace | urn:www.agenziaentrate.gov.it:specificheTecniche:sco:730 |
| children | m730:Familiari m730:QuadroA m730:QuadroB m730:QuadroC m730:QuadroD m730:QuadroE m730:QuadroF m730:QuadroG m730:ProspettoLiquidazione |

element **Dati_Contabili_Type/Familiari**

| | |
|-----------|--|
| diagram | |
| namespace | urn:www.agenziaentrate.gov.it:specificheTecniche:sco:730 |
| type | m730:Familiari_Type |
| children | m730:PrimoModulo m730:Modulo |

element **Dati_Contabili_Type/QuadroA**

| | |
|-----------|--|
| diagram | |
| namespace | urn:www.agenziaentrate.gov.it:specificheTecniche:sco:730 |
| type | m730:Redditi_Terreni_Type |
| children | m730:Modulo |

element **Dati_Contabili_Type/QuadroB**

| | |
|-----------|--|
| diagram | |
| namespace | urn:www.agenziaentrate.gov.it:specificheTecniche:sco:730 |
| type | m730:Redditi_Fabbricati_Type |
| children | m730:Modulo |

element **Dati_Contabili_Type/QuadroC**

| | |
|-----------|--|
| diagram | |
| namespace | urn:www.agenziaentrate.gov.it:specificheTecniche:sco:730 |
| type | m730:Redditi_Lavoro_Dip_Type |
| children | m730:PrimoModulo m730:Modulo |

element **Dati_Contabili_Type/QuadroD**

| | |
|-----------|--|
| diagram | |
| namespace | urn:www.agenziaentrate.gov.it:specificheTecniche:sco:730 |
| type | extension of m730:Altri_Redditi_Type |
| children | m730:Modulo |

element **Dati_Contabili_Type/QuadroE**

| | |
|-----------|--|
| diagram | |
| namespace | urn:www.agenziaentrate.gov.it:specificheTecniche:sco:730 |
| type | m730:Oneri_Type |
| children | m730:PrimoModulo m730:Modulo |

element **Dati_Contabili_Type/QuadroF**

| | |
|-----------|--|
| diagram | |
| namespace | urn:www.agenziaentrate.gov.it:specificheTecniche:sco:730 |
| type | m730:Acconti_Ritenute_Type |
| children | m730:PrimoModulo m730:Modulo |

element **Dati_Contabili_Type/QuadroG**

| | |
|-----------|--|
| diagram | |
| namespace | urn:www.agenziaentrate.gov.it:specificheTecniche:sco:730 |
| type | m730:Crediti_Imposta |
| children | m730:PrimoModulo m730:Modulo |

element **Dati_Contabili_Type/ProspettoLiquidazione**

| | |
|-----------|--|
| diagram | |
| namespace | urn:www.agenziaentrate.gov.it:specificheTecniche:sco:730 |
| type | m730:Prospetto_Liquidazione_Type |
| children | m730:PrimoModulo m730:Modulo |

complexType **Dati_Contratto_Type**

| | |
|-----------|--|
| diagram | |
| namespace | urn:www.agenziaentrate.gov.it:specificheTecniche:sco:730 |
| children | m730:DataRegContratto m730:SerieContratto m730:NumeroContratto m730:Sottonumero m730:CodiceUfficio |

element **Dati_Contratto_Type/DataRegContratto**

| diagram | | | | | |
|-----------|--|------|-------|---------|---|
| namespace | urn:www.agenziaentrate.gov.it:specificheTecniche:sco:730 | | | | |
| type | DatoDT_Type | | | | |
| facets | <table border="1"> <thead> <tr> <th>Kind</th> <th>Value</th> </tr> </thead> <tbody> <tr> <td>pattern</td> <td>(((0[1-9][12][0-9][301])(0[13578][10]12)(\d{4})) ((0[1-9][12][0-9][30](0[469][11](\d{4})) ((0[1-9][1[0-9]]2[0-8])(02)(\d{4})) ((29)(02)([02468][048]00)) ((29)(02)([13579][26]00)) ((29)(02)([0-9][0-9][0][48])) ((29)(02)([0-9][0-9][2468][048])) ((29)(02)([0-9][0-9][13579][26])))))</td> </tr> </tbody> </table> | Kind | Value | pattern | (((0[1-9][12][0-9][301])(0[13578][10]12)(\d{4})) ((0[1-9][12][0-9][30](0[469][11](\d{4})) ((0[1-9][1[0-9]]2[0-8])(02)(\d{4})) ((29)(02)([02468][048]00)) ((29)(02)([13579][26]00)) ((29)(02)([0-9][0-9][0][48])) ((29)(02)([0-9][0-9][2468][048])) ((29)(02)([0-9][0-9][13579][26]))))) |
| Kind | Value | | | | |
| pattern | (((0[1-9][12][0-9][301])(0[13578][10]12)(\d{4})) ((0[1-9][12][0-9][30](0[469][11](\d{4})) ((0[1-9][1[0-9]]2[0-8])(02)(\d{4})) ((29)(02)([02468][048]00)) ((29)(02)([13579][26]00)) ((29)(02)([0-9][0-9][0][48])) ((29)(02)([0-9][0-9][2468][048])) ((29)(02)([0-9][0-9][13579][26]))))) | | | | |

element **Dati_Contratto_Type/SerieContratto**

| diagram | | | | | | | | | | | | | | | |
|-------------|--|------|-------|---------|--|-------------|---|-------------|----|-------------|----|-------------|----|-------------|----|
| namespace | urn:www.agenziaentrate.gov.it:specificheTecniche:sco:730 | | | | | | | | | | | | | | |
| type | m730:Serie_Registrazione_Contratto_Type | | | | | | | | | | | | | | |
| facets | <table border="1"> <thead> <tr> <th>Kind</th> <th>Value</th> </tr> </thead> <tbody> <tr> <td>pattern</td> <td>([0-9A-Z-] &quot;){1}([0-9A-Z&amp;] ' -\ \. / ^ \^\(\\) À È É Ì Ò Ù Ü &quot;;\\ / +)*</td> </tr> <tr> <td>enumeration</td> <td>3</td> </tr> <tr> <td>enumeration</td> <td>3A</td> </tr> <tr> <td>enumeration</td> <td>3B</td> </tr> <tr> <td>enumeration</td> <td>3P</td> </tr> <tr> <td>enumeration</td> <td>3T</td> </tr> </tbody> </table> | Kind | Value | pattern | ([0-9A-Z-] "){1}([0-9A-Z&] ' -\ \. / ^ \^\(\\) À È É Ì Ò Ù Ü ";\\ / +)* | enumeration | 3 | enumeration | 3A | enumeration | 3B | enumeration | 3P | enumeration | 3T |
| Kind | Value | | | | | | | | | | | | | | |
| pattern | ([0-9A-Z-] "){1}([0-9A-Z&] ' -\ \. / ^ \^\(\\) À È É Ì Ò Ù Ü ";\\ / +)* | | | | | | | | | | | | | | |
| enumeration | 3 | | | | | | | | | | | | | | |
| enumeration | 3A | | | | | | | | | | | | | | |
| enumeration | 3B | | | | | | | | | | | | | | |
| enumeration | 3P | | | | | | | | | | | | | | |
| enumeration | 3T | | | | | | | | | | | | | | |

element **Dati_Contratto_Type/NumeroContratto**

| diagram | | | | | |
|-----------|---|------|-------|---------|--|
| namespace | urn:www.agenziaentrate.gov.it:specificheTecniche:sco:730 | | | | |
| type | DatoAN_Type | | | | |
| facets | <table border="1"> <thead> <tr> <th>Kind</th> <th>Value</th> </tr> </thead> <tbody> <tr> <td>pattern</td> <td>([0-9A-Z-] &quot;){1}([0-9A-Z&amp;] ' -\ \. / ^ \^\(\\) À È É Ì Ò Ù Ü &quot;;\\ / +)*</td> </tr> </tbody> </table> | Kind | Value | pattern | ([0-9A-Z-] "){1}([0-9A-Z&] ' -\ \. / ^ \^\(\\) À È É Ì Ò Ù Ü ";\\ / +)* |
| Kind | Value | | | | |
| pattern | ([0-9A-Z-] "){1}([0-9A-Z&] ' -\ \. / ^ \^\(\\) À È É Ì Ò Ù Ü ";\\ / +)* | | | | |

element **Dati_Contratto_Type/Sottonumero**

| | |
|-----------|--|
| diagram | |
| namespace | urn:www.agenziaentrate.gov.it:specificheTecniche:sco:730 |
| type | DatoAN_Type |
| facets | Kind Value pattern ([0-9A-Z\-\-]*)"}{1}([0-9A-Z&:] ' \"/> |

element **Dati_Contratto_Type/CodiceUfficio**

| | |
|-----------|--|
| diagram | |
| namespace | urn:www.agenziaentrate.gov.it:specificheTecniche:sco:730 |
| type | restriction of DatoAN_Type |
| facets | Kind Value pattern ([0-9A-Z\-\-]*)"}{1}([0-9A-Z&:] ' \"/> |

complexType **Dati_Familiare_Type**

| | |
|-----------|--|
| diagram | |
| namespace | urn:www.agenziaentrate.gov.it:specificheTecniche:sco:730 |
| children | m730:CodiceFiscale m730:Mesi m730:MesiMinore m730:PercDetraz m730:PercDetrazCon m730:Affidamento |

element **Dati_Familiare_Type/CodiceFiscale**

| | |
|-----------|---|
| diagram | |
| namespace | urn:www.agenziaentrate.gov.it:specificheTecniche:sco:730 |
| type | DatoCF_Type |
| facets | Kind Value pattern [0-9]{11}[A-Z]{6}[0-9LMNPQRSTUVWXYZ]{2}[A-Z]{1}[0-9LMNPQRSTUVWXYZ]{2}[A-Z]{1}[0-9LMNPQRSTUVWXYZ]{3}[A-Z]{1} |

element Dati_Familiare_Type/Mesi

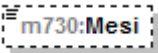
| | |
|-----------|---|
| diagram |  |
| namespace | urn:www.agenziaentrate.gov.it:specificheTecniche:sco:730 |
| type | DatoNP_Type |
| facets | Kind Value pattern [1-9]{1}[0-9]* |

element Dati_Familiare_Type/MesiMinore

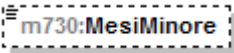
| | |
|-----------|---|
| diagram |  |
| namespace | urn:www.agenziaentrate.gov.it:specificheTecniche:sco:730 |
| type | DatoNP_Type |
| facets | Kind Value pattern [1-9]{1}[0-9]* |

element Dati_Familiare_Type/PercDetraz

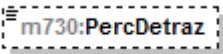
| | |
|-----------|---|
| diagram |  |
| namespace | urn:www.agenziaentrate.gov.it:specificheTecniche:sco:730 |
| type | DatoPC_Type |
| facets | Kind Value pattern [0-9]?[0-9](, d{1,3})? 100,(0{1,3})? |

element Dati_Familiare_Type/PercDetrazCon

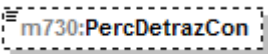
| | |
|-----------|--|
| diagram |  |
| namespace | urn:www.agenziaentrate.gov.it:specificheTecniche:sco:730 |
| type | DatoAN_Type |
| facets | Kind Value pattern ([0-9A-Z\-\] \"){1}([0-9A-Z&:] " \- \., / "^\(\ \) \) \À \È \Ò \Ù \" \ \\ \ +)* |

element Dati_Familiare_Type/Affidamento

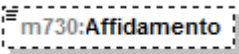
| | |
|-----------|---|
| diagram |  |
| namespace | urn:www.agenziaentrate.gov.it:specificheTecniche:sco:730 |
| type | DatoCB_Type |
| facets | Kind Value pattern [01] |

complexType Dati_Nascita_PF_Type

| | |
|-----------|--|
| diagram | |
| namespace | urn:www.agenziaentrate.gov.it:specificheTecniche:sco:730 |
| children | m730:Sesso m730:DataNascita m730:ComuneNascita m730:ProvinciaNascita |

element Dati_Nascita_PF_Type/Sesso

| | | | | | | | | | |
|-------------|--|------|-------|---------|---|-------------|---|-------------|---|
| diagram | | | | | | | | | |
| namespace | urn:www.agenziaentrate.gov.it:specificheTecniche:sco:730 | | | | | | | | |
| type | Sesso Type | | | | | | | | |
| facets | <table border="0"> <tr> <td>Kind</td> <td>Value</td> </tr> <tr> <td>pattern</td> <td>(([0-9A-Z-])&quot;){1}([0-9A-Z&amp;:] ' - \., / ° ^\ \\(\) À É È Ì Ò Ù Û &quot; \ \\ /+)*</td> </tr> <tr> <td>enumeration</td> <td>M</td> </tr> <tr> <td>enumeration</td> <td>F</td> </tr> </table> | Kind | Value | pattern | (([0-9A-Z-])"){1}([0-9A-Z&:] ' - \., / ° ^\ \\(\) À É È Ì Ò Ù Û " \ \\ /+)* | enumeration | M | enumeration | F |
| Kind | Value | | | | | | | | |
| pattern | (([0-9A-Z-])"){1}([0-9A-Z&:] ' - \., / ° ^\ \\(\) À É È Ì Ò Ù Û " \ \\ /+)* | | | | | | | | |
| enumeration | M | | | | | | | | |
| enumeration | F | | | | | | | | |

element Dati_Nascita_PF_Type/DataNascita

| | | | | | |
|-----------|--|------|-------|---------|---|
| diagram | | | | | |
| namespace | urn:www.agenziaentrate.gov.it:specificheTecniche:sco:730 | | | | |
| type | DatoDT Type | | | | |
| facets | <table border="0"> <tr> <td>Kind</td> <td>Value</td> </tr> <tr> <td>pattern</td> <td>((([0-9]{1-9}[12][0-9]{3}[01])(0[13578][10]12)\d{4})) ((([0-9]{1-9}[12][0-9]{30}(0[469][11]\d{4})) ((0[1-9][1[0-9]]2[0-8])(02)\d{4})) ((29)(02)[02468][048]00)) ((29)(02)[13579][26]00)) ((29)(02)[0-9][0-9][0][48])) ((29)(02)[0-9][0-9][2468][048])) ((29)(02)[0-9][0-9][13579][26]))</td> </tr> </table> | Kind | Value | pattern | ((([0-9]{1-9}[12][0-9]{3}[01])(0[13578][10]12)\d{4})) ((([0-9]{1-9}[12][0-9]{30}(0[469][11]\d{4})) ((0[1-9][1[0-9]]2[0-8])(02)\d{4})) ((29)(02)[02468][048]00)) ((29)(02)[13579][26]00)) ((29)(02)[0-9][0-9][0][48])) ((29)(02)[0-9][0-9][2468][048])) ((29)(02)[0-9][0-9][13579][26])) |
| Kind | Value | | | | |
| pattern | ((([0-9]{1-9}[12][0-9]{3}[01])(0[13578][10]12)\d{4})) ((([0-9]{1-9}[12][0-9]{30}(0[469][11]\d{4})) ((0[1-9][1[0-9]]2[0-8])(02)\d{4})) ((29)(02)[02468][048]00)) ((29)(02)[13579][26]00)) ((29)(02)[0-9][0-9][0][48])) ((29)(02)[0-9][0-9][2468][048])) ((29)(02)[0-9][0-9][13579][26])) | | | | |

element Dati_Nascita_PF_Type/ComuneNascita

| | | | | | |
|-----------|--|------|-------|---------|---|
| diagram | | | | | |
| namespace | urn:www.agenziaentrate.gov.it:specificheTecniche:sco:730 | | | | |
| type | DatoAN Type | | | | |
| facets | <table border="0"> <tr> <td>Kind</td> <td>Value</td> </tr> <tr> <td>pattern</td> <td>(([0-9A-Z-])&quot;){1}([0-9A-Z&amp;:] ' - \., / ° ^\ \\(\) À É È Ì Ò Ù Û &quot; \ \\ /+)*</td> </tr> </table> | Kind | Value | pattern | (([0-9A-Z-])"){1}([0-9A-Z&:] ' - \., / ° ^\ \\(\) À É È Ì Ò Ù Û " \ \\ /+)* |
| Kind | Value | | | | |
| pattern | (([0-9A-Z-])"){1}([0-9A-Z&:] ' - \., / ° ^\ \\(\) À É È Ì Ò Ù Û " \ \\ /+)* | | | | |

element Dati_Nascita_PF_Type/ProvinciaNascita

| | |
|-----------|--|
| diagram | |
| namespace | urn:www.agenziaentrate.gov.it:specificheTecniche:sco:730 |
| type | PN_Type |

complexType Dati_Primo_Figlio_Type

| | |
|-----------|---|
| diagram | |
| namespace | urn:www.agenziaentrate.gov.it:specificheTecniche:sco:730 |
| children | m730:Tipo m730:CodiceFiscale m730:Mesi m730:MesiMinore m730:PercDetraz m730:Affidamento |

element Dati_Primo_Figlio_Type/Tipo

| | | | | | | | | | |
|-------------|--|------|-------|---------|---|-------------|---|-------------|---|
| diagram | | | | | | | | | |
| namespace | urn:www.agenziaentrate.gov.it:specificheTecniche:sco:730 | | | | | | | | |
| type | restriction of DatoAN_Type | | | | | | | | |
| facets | <table border="0"> <tr> <td>Kind</td> <td>Value</td> </tr> <tr> <td>pattern</td> <td>([0-9A-Z-] &quot;){1}([0-9A-Z&amp;] ' \\- \\. / ° \\^\\(\\ \\)\\ À È É Ì Ò Ù Ü &quot; \\ \\ \\ +)*</td> </tr> <tr> <td>enumeration</td> <td>F</td> </tr> <tr> <td>enumeration</td> <td>D</td> </tr> </table> | Kind | Value | pattern | ([0-9A-Z-] "){1}([0-9A-Z&] ' \\- \\. / ° \\^\\(\\ \\)\\ À È É Ì Ò Ù Ü " \\ \\ \\ +)* | enumeration | F | enumeration | D |
| Kind | Value | | | | | | | | |
| pattern | ([0-9A-Z-] "){1}([0-9A-Z&] ' \\- \\. / ° \\^\\(\\ \\)\\ À È É Ì Ò Ù Ü " \\ \\ \\ +)* | | | | | | | | |
| enumeration | F | | | | | | | | |
| enumeration | D | | | | | | | | |

element Dati_Primo_Figlio_Type/CodiceFiscale

| | | | | | |
|-----------|---|------|-------|---------|--|
| diagram | | | | | |
| namespace | urn:www.agenziaentrate.gov.it:specificheTecniche:sco:730 | | | | |
| type | DatoCF_Type | | | | |
| facets | <table border="0"> <tr> <td>Kind</td> <td>Value</td> </tr> <tr> <td>pattern</td> <td>[0-9]{11}[A-Z]{6}[0-9LMNPQRSTU]{2}[A-Z]{1}[0-9LMNPQRSTU]{2}[A-Z]{1}[0-9LMNPQRSTU]{3}[A-Z]{1}</td> </tr> </table> | Kind | Value | pattern | [0-9]{11}[A-Z]{6}[0-9LMNPQRSTU]{2}[A-Z]{1}[0-9LMNPQRSTU]{2}[A-Z]{1}[0-9LMNPQRSTU]{3}[A-Z]{1} |
| Kind | Value | | | | |
| pattern | [0-9]{11}[A-Z]{6}[0-9LMNPQRSTU]{2}[A-Z]{1}[0-9LMNPQRSTU]{2}[A-Z]{1}[0-9LMNPQRSTU]{3}[A-Z]{1} | | | | |

element Dati_Primo_Figlio_Type/Mesi

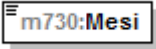
| diagram |  | | | | | | | | | | | | | | | | | | | | | | | | | | | | |
|-------------|--|------|-------|---------|----------------|-------------|---|-------------|---|-------------|---|-------------|---|-------------|---|-------------|---|-------------|---|-------------|---|-------------|---|-------------|----|-------------|----|-------------|----|
| namespace | urn:www.agenziaentrate.gov.it:specificheTecniche:sco:730 | | | | | | | | | | | | | | | | | | | | | | | | | | | | |
| type | m730:Mesi_Type | | | | | | | | | | | | | | | | | | | | | | | | | | | | |
| facets | <table border="1"> <thead> <tr> <th>Kind</th> <th>Value</th> </tr> </thead> <tbody> <tr> <td>pattern</td> <td>[1-9]{1}[0-9]*</td> </tr> <tr> <td>enumeration</td> <td>1</td> </tr> <tr> <td>enumeration</td> <td>2</td> </tr> <tr> <td>enumeration</td> <td>3</td> </tr> <tr> <td>enumeration</td> <td>4</td> </tr> <tr> <td>enumeration</td> <td>5</td> </tr> <tr> <td>enumeration</td> <td>6</td> </tr> <tr> <td>enumeration</td> <td>7</td> </tr> <tr> <td>enumeration</td> <td>8</td> </tr> <tr> <td>enumeration</td> <td>9</td> </tr> <tr> <td>enumeration</td> <td>10</td> </tr> <tr> <td>enumeration</td> <td>11</td> </tr> <tr> <td>enumeration</td> <td>12</td> </tr> </tbody> </table> | Kind | Value | pattern | [1-9]{1}[0-9]* | enumeration | 1 | enumeration | 2 | enumeration | 3 | enumeration | 4 | enumeration | 5 | enumeration | 6 | enumeration | 7 | enumeration | 8 | enumeration | 9 | enumeration | 10 | enumeration | 11 | enumeration | 12 |
| Kind | Value | | | | | | | | | | | | | | | | | | | | | | | | | | | | |
| pattern | [1-9]{1}[0-9]* | | | | | | | | | | | | | | | | | | | | | | | | | | | | |
| enumeration | 1 | | | | | | | | | | | | | | | | | | | | | | | | | | | | |
| enumeration | 2 | | | | | | | | | | | | | | | | | | | | | | | | | | | | |
| enumeration | 3 | | | | | | | | | | | | | | | | | | | | | | | | | | | | |
| enumeration | 4 | | | | | | | | | | | | | | | | | | | | | | | | | | | | |
| enumeration | 5 | | | | | | | | | | | | | | | | | | | | | | | | | | | | |
| enumeration | 6 | | | | | | | | | | | | | | | | | | | | | | | | | | | | |
| enumeration | 7 | | | | | | | | | | | | | | | | | | | | | | | | | | | | |
| enumeration | 8 | | | | | | | | | | | | | | | | | | | | | | | | | | | | |
| enumeration | 9 | | | | | | | | | | | | | | | | | | | | | | | | | | | | |
| enumeration | 10 | | | | | | | | | | | | | | | | | | | | | | | | | | | | |
| enumeration | 11 | | | | | | | | | | | | | | | | | | | | | | | | | | | | |
| enumeration | 12 | | | | | | | | | | | | | | | | | | | | | | | | | | | | |

element Dati_Primo_Figlio_Type/MesiMinore

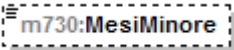
| diagram |  | | | | | | | | | | | | | | | | | | | | | | | | | | | | |
|-------------|--|------|-------|---------|----------------|-------------|---|-------------|---|-------------|---|-------------|---|-------------|---|-------------|---|-------------|---|-------------|---|-------------|---|-------------|----|-------------|----|-------------|----|
| namespace | urn:www.agenziaentrate.gov.it:specificheTecniche:sco:730 | | | | | | | | | | | | | | | | | | | | | | | | | | | | |
| type | m730:Mesi_Type | | | | | | | | | | | | | | | | | | | | | | | | | | | | |
| facets | <table border="1"> <thead> <tr> <th>Kind</th> <th>Value</th> </tr> </thead> <tbody> <tr> <td>pattern</td> <td>[1-9]{1}[0-9]*</td> </tr> <tr> <td>enumeration</td> <td>1</td> </tr> <tr> <td>enumeration</td> <td>2</td> </tr> <tr> <td>enumeration</td> <td>3</td> </tr> <tr> <td>enumeration</td> <td>4</td> </tr> <tr> <td>enumeration</td> <td>5</td> </tr> <tr> <td>enumeration</td> <td>6</td> </tr> <tr> <td>enumeration</td> <td>7</td> </tr> <tr> <td>enumeration</td> <td>8</td> </tr> <tr> <td>enumeration</td> <td>9</td> </tr> <tr> <td>enumeration</td> <td>10</td> </tr> <tr> <td>enumeration</td> <td>11</td> </tr> <tr> <td>enumeration</td> <td>12</td> </tr> </tbody> </table> | Kind | Value | pattern | [1-9]{1}[0-9]* | enumeration | 1 | enumeration | 2 | enumeration | 3 | enumeration | 4 | enumeration | 5 | enumeration | 6 | enumeration | 7 | enumeration | 8 | enumeration | 9 | enumeration | 10 | enumeration | 11 | enumeration | 12 |
| Kind | Value | | | | | | | | | | | | | | | | | | | | | | | | | | | | |
| pattern | [1-9]{1}[0-9]* | | | | | | | | | | | | | | | | | | | | | | | | | | | | |
| enumeration | 1 | | | | | | | | | | | | | | | | | | | | | | | | | | | | |
| enumeration | 2 | | | | | | | | | | | | | | | | | | | | | | | | | | | | |
| enumeration | 3 | | | | | | | | | | | | | | | | | | | | | | | | | | | | |
| enumeration | 4 | | | | | | | | | | | | | | | | | | | | | | | | | | | | |
| enumeration | 5 | | | | | | | | | | | | | | | | | | | | | | | | | | | | |
| enumeration | 6 | | | | | | | | | | | | | | | | | | | | | | | | | | | | |
| enumeration | 7 | | | | | | | | | | | | | | | | | | | | | | | | | | | | |
| enumeration | 8 | | | | | | | | | | | | | | | | | | | | | | | | | | | | |
| enumeration | 9 | | | | | | | | | | | | | | | | | | | | | | | | | | | | |
| enumeration | 10 | | | | | | | | | | | | | | | | | | | | | | | | | | | | |
| enumeration | 11 | | | | | | | | | | | | | | | | | | | | | | | | | | | | |
| enumeration | 12 | | | | | | | | | | | | | | | | | | | | | | | | | | | | |

element Dati_Primo_Figlio_Type/PercDetraz

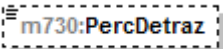
| diagram |  | | | | |
|-----------|---|------|-------|---------|--------------------------------------|
| namespace | urn:www.agenziaentrate.gov.it:specificheTecniche:sco:730 | | | | |
| type | DatoPC_Type | | | | |
| facets | <table border="1"> <thead> <tr> <th>Kind</th> <th>Value</th> </tr> </thead> <tbody> <tr> <td>pattern</td> <td>[0-9]?[0-9](,\d{1,3})? 100,(0{1,3})?</td> </tr> </tbody> </table> | Kind | Value | pattern | [0-9]?[0-9](,\d{1,3})? 100,(0{1,3})? |
| Kind | Value | | | | |
| pattern | [0-9]?[0-9](,\d{1,3})? 100,(0{1,3})? | | | | |

element **Dati_Primo_Figlio_Type/Affidamento**

| | |
|-----------|--|
| diagram | |
| namespace | urn:www.agenziaentrate.gov.it:specificheTecniche:sco:730 |
| type | DatoCB_Type |
| facets | Kind Value pattern [01] |

complexType **Dati_Registrazione_Accatastamento_Recupero_Patrimonio_Edilizio_Type**

| | |
|-----------|---|
| diagram | |
| namespace | urn:www.agenziaentrate.gov.it:specificheTecniche:sco:730 |
| children | m730:NOrdImmobile m730:Condominio m730:EstremiRegistrazioneContratto m730:DataDomandaAccatastamento m730:NumeroDomandaAccatastamento m730:ProvinciaUfficioDomandaAccatastamento |

element **Dati_Registrazione_Accatastamento_Recupero_Patrimonio_Edilizio_Type/NOrdImmobile**

| | |
|-----------|--|
| diagram | |
| namespace | urn:www.agenziaentrate.gov.it:specificheTecniche:sco:730 |
| type | DatoNP_Type |
| facets | Kind Value pattern [1-9]{1}[0-9]* |

element **Dati_Registrazione_Accatastamento_Recupero_Patrimonio_Edilizio_Type/Condominio**

| | |
|-----------|--|
| diagram | |
| namespace | urn:www.agenziaentrate.gov.it:specificheTecniche:sco:730 |
| type | DatoCB_Type |
| facets | Kind Value pattern [01] |

element

Dati_Registrazione_Accatastamento_Recupero_Patrimonio_Edilizio_Type/EstremiRegistrazioneContra
tto

| | |
|-----------|--|
| diagram | |
| namespace | urn:www.agenziaentrate.gov.it:specificheTecniche:sco:730 |
| type | m730:Dati_Contratto_Type |
| children | m730:DataRegContratto m730:SerieContratto m730:NumeroContratto m730:Sottonumero m730:CodiceUfficio |

element

Dati_Registrazione_Accatastamento_Recupero_Patrimonio_Edilizio_Type/DataDomandaAccatastamen
to

| diagram | | | | | |
|-----------|--|------|-------|---------|---|
| namespace | urn:www.agenziaentrate.gov.it:specificheTecniche:sco:730 | | | | |
| type | DatoDT_Type | | | | |
| facets | <table border="1"> <thead> <tr> <th>Kind</th> <th>Value</th> </tr> </thead> <tbody> <tr> <td>pattern</td> <td>((([0-9]{12}[0-9]{3}[01])([0-9]{10}[12]{4})) ([0-9]{12}[0-9]{30}[0-9]{11}{4})) ([0-9]{2}[0-9]{2}{4}) ((29)(02)[0-9]{2}[048]{00}) ((29)(02)[13579]{26}{00}) ((29)(02)[0-9]{0-9}[0-9]{48}) ((29)(02)[0-9]{0-9}[2468]{048}) ((29)(02)[0-9]{0-9}[13579]{26}))</td> </tr> </tbody> </table> | Kind | Value | pattern | ((([0-9]{12}[0-9]{3}[01])([0-9]{10}[12]{4})) ([0-9]{12}[0-9]{30}[0-9]{11}{4})) ([0-9]{2}[0-9]{2}{4}) ((29)(02)[0-9]{2}[048]{00}) ((29)(02)[13579]{26}{00}) ((29)(02)[0-9]{0-9}[0-9]{48}) ((29)(02)[0-9]{0-9}[2468]{048}) ((29)(02)[0-9]{0-9}[13579]{26})) |
| Kind | Value | | | | |
| pattern | ((([0-9]{12}[0-9]{3}[01])([0-9]{10}[12]{4})) ([0-9]{12}[0-9]{30}[0-9]{11}{4})) ([0-9]{2}[0-9]{2}{4}) ((29)(02)[0-9]{2}[048]{00}) ((29)(02)[13579]{26}{00}) ((29)(02)[0-9]{0-9}[0-9]{48}) ((29)(02)[0-9]{0-9}[2468]{048}) ((29)(02)[0-9]{0-9}[13579]{26})) | | | | |

element

Dati_Registrazione_Accatastamento_Recupero_Patrimonio_Edilizio_Type/NumeroDomandaAccatasta
mento

| diagram | | | | | |
|-----------|--|------|-------|---------|---|
| namespace | urn:www.agenziaentrate.gov.it:specificheTecniche:sco:730 | | | | |
| type | DatoAN_Type | | | | |
| facets | <table border="1"> <thead> <tr> <th>Kind</th> <th>Value</th> </tr> </thead> <tbody> <tr> <td>pattern</td> <td>([0-9A-Z-] \&quot;){1}([0-9A-Z&amp;#x201E;] - \., / ^\\(\\) À É Ì Ò Ù Ú &quot; \\ \\+)*</td> </tr> </tbody> </table> | Kind | Value | pattern | ([0-9A-Z-] \"){1}([0-9A-Z&#x201E;] - \., / ^\\(\\) À É Ì Ò Ù Ú " \\ \\+)* |
| Kind | Value | | | | |
| pattern | ([0-9A-Z-] \"){1}([0-9A-Z&#x201E;] - \., / ^\\(\\) À É Ì Ò Ù Ú " \\ \\+)* | | | | |

element

Dati_Registrazione_Accatastamento_Recupero_Patrimonio_Edilizio_Type/ProvinciaUfficioDomandaAccatastamento

| diagram | | | | | |
|-----------|--|------|-------|---------|---|
| namespace | urn:www.agenziaentrate.gov.it:specificheTecniche:sco:730 | | | | |
| type | DatoAN_Type | | | | |
| facets | <table border="1"> <thead> <tr> <th>Kind</th> <th>Value</th> </tr> </thead> <tbody> <tr> <td>pattern</td> <td>(([0-9A-Z-] \&quot;){1}([0-9A-Z&amp;:] \- \., / \°\^\(\)\) À É È Ì Ò Ù Û &quot; \ \\ / +)*</td> </tr> </tbody> </table> | Kind | Value | pattern | (([0-9A-Z-] \"){1}([0-9A-Z&:] \- \., / \°\^\(\)\) À É È Ì Ò Ù Û " \ \\ / +)* |
| Kind | Value | | | | |
| pattern | (([0-9A-Z-] \"){1}([0-9A-Z&:] \- \., / \°\^\(\)\) À É È Ì Ò Ù Û " \ \\ / +)* | | | | |

complexType Debito_Type

| | |
|-----------|--|
| diagram | |
| namespace | urn:www.agenziaentrate.gov.it:specificheTecniche:sco:730 |
| children | m730:NonVersare m730:ImportoDaTrattenere |

element Debito_Type/NonVersare

| diagram | | | | | |
|-----------|---|------|-------|---------|----------------|
| namespace | urn:www.agenziaentrate.gov.it:specificheTecniche:sco:730 | | | | |
| type | DatoNP_Type | | | | |
| facets | <table border="1"> <thead> <tr> <th>Kind</th> <th>Value</th> </tr> </thead> <tbody> <tr> <td>pattern</td> <td>[1-9]{1}[0-9]*</td> </tr> </tbody> </table> | Kind | Value | pattern | [1-9]{1}[0-9]* |
| Kind | Value | | | | |
| pattern | [1-9]{1}[0-9]* | | | | |

element Debito_Type/ImportoDaTrattenere

| diagram | | | | | |
|-----------|---|------|-------|---------|----------------|
| namespace | urn:www.agenziaentrate.gov.it:specificheTecniche:sco:730 | | | | |
| type | DatoNP_Type | | | | |
| facets | <table border="1"> <thead> <tr> <th>Kind</th> <th>Value</th> </tr> </thead> <tbody> <tr> <td>pattern</td> <td>[1-9]{1}[0-9]*</td> </tr> </tbody> </table> | Kind | Value | pattern | [1-9]{1}[0-9]* |
| Kind | Value | | | | |
| pattern | [1-9]{1}[0-9]* | | | | |

complexType Deduzioni_Modulo_Type

| | |
|---------|--|
| diagram | |
|---------|--|

| | |
|-----------|---|
| namespace | urn:www.agenziaentrate.gov.it:specificheTecniche:sco:730 |
| children | m730:AssegnoConiuge m730:AltriOneri m730:AcquistoCostruzioneAbitLocazione |

element Deduzioni_Modulo_Type/AssegnoConiuge

| | |
|-----------|---|
| diagram | |
| namespace | urn:www.agenziaentrate.gov.it:specificheTecniche:sco:730 |
| type | m730:Assegno_Coniuge_Type |
| children | m730:CodiceFiscale m730:Importo |

element Deduzioni_Modulo_Type/AltriOneri

| | |
|-----------|--|
| diagram | |
| namespace | urn:www.agenziaentrate.gov.it:specificheTecniche:sco:730 |
| type | m730:Altri_Oneri_Type |
| children | m730:Codice m730:Importo |

element Deduzioni_Modulo_Type/AcquistoCostruzioneAbitLocazione

| | |
|-----------|---|
| diagram | |
| namespace | urn:www.agenziaentrate.gov.it:specificheTecniche:sco:730 |
| type | m730:Acquisto_Costruzione_Abit_Locazione |
| children | m730:DataStipula m730:Spesa m730:InteressiMutuo |

complexType **Deduzioni_Type**

| | |
|------------------|---|
| <p>diagram</p> | |
| <p>namespace</p> | <p>urn:www.agenziaentrate.gov.it:specificheTecniche:sco:730</p> |
| <p>children</p> | <p>m730:ContributiPrevAss m730:AssegnoConiuge m730:ContributiColf m730:ErogazioniIstituzioniReligiose m730:SpesePortatoriHandicap m730:AltriOneri m730:DeducibilitaOrdinaria m730:LavoratoriPrimaOccupazione m730:FondiInSquilibrioFinanziario m730:FamiliariACarico m730:FondoPensioneDipendentiPubblici m730:AcquistoCostruzioneAbitLocazione</p> |

element **Deduzioni_Type/ContributiPrevAss**

| | | | | | |
|------------------|---|------|-------|---------|----------------|
| <p>diagram</p> | | | | | |
| <p>namespace</p> | <p>urn:www.agenziaentrate.gov.it:specificheTecniche:sco:730</p> | | | | |
| <p>type</p> | <p>DatoNP_Type</p> | | | | |
| <p>facets</p> | <table border="1"> <tr> <td>Kind</td> <td>Value</td> </tr> <tr> <td>pattern</td> <td>[1-9]{1}[0-9]*</td> </tr> </table> | Kind | Value | pattern | [1-9]{1}[0-9]* |
| Kind | Value | | | | |
| pattern | [1-9]{1}[0-9]* | | | | |

element **Deduzioni_Type/AssegnoConiuge**

| | |
|----------------|--|
| <p>diagram</p> | |
|----------------|--|

| | |
|-----------|---|
| namespace | urn:www.agenziaentrate.gov.it:specificheTecniche:sco:730 |
| type | m730:Assegno_Coniuge_Type |
| children | m730:CodiceFiscale m730:Importo |

element Deduzioni_Type/ContributiColf

| diagram | | | | | |
|-----------|---|------|-------|---------|----------------|
| namespace | urn:www.agenziaentrate.gov.it:specificheTecniche:sco:730 | | | | |
| type | DatoNP_Type | | | | |
| facets | <table border="1"> <tr> <th>Kind</th> <th>Value</th> </tr> <tr> <td>pattern</td> <td>[1-9]{1}[0-9]*</td> </tr> </table> | Kind | Value | pattern | [1-9]{1}[0-9]* |
| Kind | Value | | | | |
| pattern | [1-9]{1}[0-9]* | | | | |

element Deduzioni_Type/ErogazioniIstituzioniReligiose

| diagram | | | | | |
|-----------|---|------|-------|---------|----------------|
| namespace | urn:www.agenziaentrate.gov.it:specificheTecniche:sco:730 | | | | |
| type | DatoNP_Type | | | | |
| facets | <table border="1"> <tr> <th>Kind</th> <th>Value</th> </tr> <tr> <td>pattern</td> <td>[1-9]{1}[0-9]*</td> </tr> </table> | Kind | Value | pattern | [1-9]{1}[0-9]* |
| Kind | Value | | | | |
| pattern | [1-9]{1}[0-9]* | | | | |

element Deduzioni_Type/SpesePortatoriHandicap

| diagram | | | | | |
|-----------|---|------|-------|---------|----------------|
| namespace | urn:www.agenziaentrate.gov.it:specificheTecniche:sco:730 | | | | |
| type | DatoNP_Type | | | | |
| facets | <table border="1"> <tr> <th>Kind</th> <th>Value</th> </tr> <tr> <td>pattern</td> <td>[1-9]{1}[0-9]*</td> </tr> </table> | Kind | Value | pattern | [1-9]{1}[0-9]* |
| Kind | Value | | | | |
| pattern | [1-9]{1}[0-9]* | | | | |

element Deduzioni_Type/AltriOneri

| | |
|-----------|--|
| diagram | |
| namespace | urn:www.agenziaentrate.gov.it:specificheTecniche:sco:730 |
| type | m730:Altri_Oneri_Type |
| children | m730:Codice m730:Importo |

element **Deduzioni_Type/DeducibilitaOrdinaria**

| | |
|-----------|--|
| diagram | <p>The diagram shows a dashed box labeled 'm730:DeducibilitaOrdinaria' connected to a solid box labeled 'm730:Contributi_Previdenza_Complementare_Type'. Inside the solid box, there are two dashed boxes: 'm730:EsclusiDalSostituto' and 'm730:NonEsclusiDalSostituto'.</p> |
| namespace | urn:www.agenziaentrate.gov.it:specificheTecniche:sco:730 |
| type | m730:Contributi_Previdenza_Complementare_Type |
| children | m730:EsclusiDalSostituto m730:NonEsclusiDalSostituto |

element **Deduzioni_Type/LavoratoriPrimaOccupazione**

| | |
|-----------|---|
| diagram | <p>The diagram shows a dashed box labeled 'm730:LavoratoriPrimaOccupazione' connected to a solid box labeled 'm730:Contributi_Previdenza_Complementare_Type'. Inside the solid box, there are two dashed boxes: 'm730:EsclusiDalSostituto' and 'm730:NonEsclusiDalSostituto'.</p> |
| namespace | urn:www.agenziaentrate.gov.it:specificheTecniche:sco:730 |
| type | m730:Contributi_Previdenza_Complementare_Type |
| children | m730:EsclusiDalSostituto m730:NonEsclusiDalSostituto |

element **Deduzioni_Type/FondiInSquilibrioFinanziario**

| | |
|-----------|---|
| diagram | <p>The diagram shows a dashed box labeled 'm730:FondiInSquilibrioFinanziario' connected to a solid box labeled 'm730:Contributi_Previdenza_Complementare_Type'. Inside the solid box, there are two dashed boxes: 'm730:EsclusiDalSostituto' and 'm730:NonEsclusiDalSostituto'.</p> |
| namespace | urn:www.agenziaentrate.gov.it:specificheTecniche:sco:730 |
| type | m730:Contributi_Previdenza_Complementare_Type |
| children | m730:EsclusiDalSostituto m730:NonEsclusiDalSostituto |

element **Deduzioni_Type/FamiliariACarico**

| | |
|-----------|--|
| diagram | |
| namespace | urn:www.agenziaentrate.gov.it:specificheTecniche:sco:730 |
| type | m730:Contributi Previdenza Complementare Type |
| children | m730:EsclusiDalSostituto m730:NonEsclusiDalSostituto |

element **Deduzioni_Type/FondoPensioneDipendentiPubblici**

| | |
|-----------|---|
| diagram | |
| namespace | urn:www.agenziaentrate.gov.it:specificheTecniche:sco:730 |
| type | m730:Fondo Pensione Dipendenti Pubblici Type |
| children | m730:Contributi m730:QuotaTFR |

element **Deduzioni_Type/AcquistoCostruzioneAbitLocazione**

| | |
|-----------|---|
| diagram | |
| namespace | urn:www.agenziaentrate.gov.it:specificheTecniche:sco:730 |
| type | m730:Acquisto Costruzione Abit Locazione |
| children | m730:DataStipula m730:Spesa m730:InteressiMutuo |

complexType **Detrazione_Crediti_Type**

| | |
|------------------|---|
| <p>diagram</p> | |
| <p>namespace</p> | <p>urn:www.agenziaentrate.gov.it:specificheTecniche:sco:730</p> |
| <p>children</p> | <p>m730:DetrazioneConiuge m730:DetrazioneFigli m730:UlterioreDetrazioneFigli m730:DetrazioneFamiliari m730:DetrazioneLavDip m730:DetrazionePens m730:DetrazioneAltriRedditi m730:DetrazioneOneri m730:DetrazioneRistrutturazione m730:DetrazioniArredolmmobili m730:DetrazioneRisparmioEnergetico m730:DetrazioneLocEAgricoliGiovani m730:AltreDetrazioni m730:CreditoPrimaCasa m730:CreditoOccupazione m730:CreditoFondiPensione m730:CreditoMediazioni m730:TotaleDetrazioniCrediti</p> |

element **Detrazione_Crediti_Type/DetrazioneConiuge**

| | |
|------------------|---|
| <p>diagram</p> | |
| <p>namespace</p> | <p>urn:www.agenziaentrate.gov.it:specificheTecniche:sco:730</p> |

| | |
|--------|--------------------------------------|
| type | DatoNP_Type |
| facets | Kind Value pattern [1-9]{1}[0-9]* |

element Detrazione_Crediti_Type/DetrazioneFigli

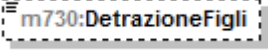
| | |
|-----------|---|
| diagram |  |
| namespace | urn:www.agenziaentrate.gov.it:specificheTecniche:sco:730 |
| type | DatoNP_Type |
| facets | Kind Value pattern [1-9]{1}[0-9]* |

element Detrazione_Crediti_Type/UlterioreDetrazioneFigli

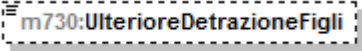
| | |
|-----------|---|
| diagram |  |
| namespace | urn:www.agenziaentrate.gov.it:specificheTecniche:sco:730 |
| type | DatoNP_Type |
| facets | Kind Value pattern [1-9]{1}[0-9]* |

element Detrazione_Crediti_Type/DetrazioneFamiliari

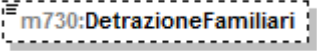
| | |
|-----------|---|
| diagram |  |
| namespace | urn:www.agenziaentrate.gov.it:specificheTecniche:sco:730 |
| type | DatoNP_Type |
| facets | Kind Value pattern [1-9]{1}[0-9]* |

element Detrazione_Crediti_Type/DetrazioneLavDip

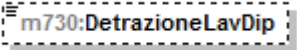
| | |
|-----------|---|
| diagram |  |
| namespace | urn:www.agenziaentrate.gov.it:specificheTecniche:sco:730 |
| type | DatoNP_Type |
| facets | Kind Value pattern [1-9]{1}[0-9]* |

element Detrazione_Crediti_Type/DetrazionePens

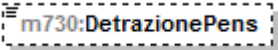
| | |
|-----------|---|
| diagram |  |
| namespace | urn:www.agenziaentrate.gov.it:specificheTecniche:sco:730 |

| | |
|--------|--------------------------------------|
| type | DatoNP_Type |
| facets | Kind Value pattern [1-9]{1}[0-9]* |

element Detrazione_Crediti_Type/DetrazioneAltriRedditi

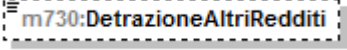
| | |
|-----------|---|
| diagram |  |
| namespace | urn:www.agenziaentrate.gov.it:specificheTecniche:sco:730 |
| type | DatoNP_Type |
| facets | Kind Value pattern [1-9]{1}[0-9]* |

element Detrazione_Crediti_Type/DetrazioneOneri

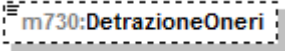
| | |
|-----------|---|
| diagram |  |
| namespace | urn:www.agenziaentrate.gov.it:specificheTecniche:sco:730 |
| type | DatoNP_Type |
| facets | Kind Value pattern [1-9]{1}[0-9]* |

element Detrazione_Crediti_Type/DetrazioneRistrutturazione

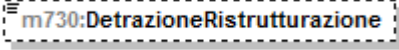
| | |
|-----------|---|
| diagram |  |
| namespace | urn:www.agenziaentrate.gov.it:specificheTecniche:sco:730 |
| type | DatoNP_Type |
| facets | Kind Value pattern [1-9]{1}[0-9]* |

element Detrazione_Crediti_Type/DetrazioniArredolImmobili

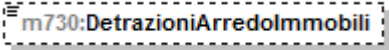
| | |
|-----------|---|
| diagram |  |
| namespace | urn:www.agenziaentrate.gov.it:specificheTecniche:sco:730 |
| type | DatoNP_Type |
| facets | Kind Value pattern [1-9]{1}[0-9]* |

element Detrazione_Crediti_Type/DetrazioneRisparmioEnergetico

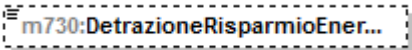
| | |
|-----------|---|
| diagram |  |
| namespace | urn:www.agenziaentrate.gov.it:specificheTecniche:sco:730 |

| | |
|--------|--------------------------------------|
| type | DatoNP_Type |
| facets | Kind Value pattern [1-9]{1}[0-9]* |

element **Detrazione_Crediti_Type/DetrazioneLocEAgricoliGiovani**

| | |
|-----------|--|
| diagram | |
| namespace | urn:www.agenziaentrate.gov.it:specificheTecniche:sco:730 |
| type | DatoNP_Type |
| facets | Kind Value pattern [1-9]{1}[0-9]* |

element **Detrazione_Crediti_Type/AltreDetrazioni**

| | |
|-----------|--|
| diagram | |
| namespace | urn:www.agenziaentrate.gov.it:specificheTecniche:sco:730 |
| type | DatoNP_Type |
| facets | Kind Value pattern [1-9]{1}[0-9]* |

element **Detrazione_Crediti_Type/CreditoPrimaCasa**

| | |
|-----------|--|
| diagram | |
| namespace | urn:www.agenziaentrate.gov.it:specificheTecniche:sco:730 |
| type | DatoNP_Type |
| facets | Kind Value pattern [1-9]{1}[0-9]* |

element **Detrazione_Crediti_Type/CreditoOccupazione**

| | |
|-----------|--|
| diagram | |
| namespace | urn:www.agenziaentrate.gov.it:specificheTecniche:sco:730 |
| type | DatoNP_Type |
| facets | Kind Value pattern [1-9]{1}[0-9]* |

element **Detrazione_Crediti_Type/CreditoFondiPensione**

| | |
|-----------|--|
| diagram | |
| namespace | urn:www.agenziaentrate.gov.it:specificheTecniche:sco:730 |

| | |
|--------|--------------------------------------|
| type | DatoNP_Type |
| facets | Kind Value pattern [1-9]{1}[0-9]* |

element Detrazione_Crediti_Type/CreditoMediazioni

| | |
|-----------|--|
| diagram | |
| namespace | urn:www.agenziaentrate.gov.it:specificheTecniche:sco:730 |
| type | DatoNP_Type |
| facets | Kind Value pattern [1-9]{1}[0-9]* |

element Detrazione_Crediti_Type/TotaleDetrazioniCrediti

| | |
|-----------|--|
| diagram | |
| namespace | urn:www.agenziaentrate.gov.it:specificheTecniche:sco:730 |
| type | DatoNP_Type |
| facets | Kind Value pattern [1-9]{1}[0-9]* |

complexType Detrazioni_Canoni_Locazione_Type

| | |
|-----------|--|
| diagram | |
| namespace | urn:www.agenziaentrate.gov.it:specificheTecniche:sco:730 |
| children | m730:InquiliniAbitazionePrincipale m730:DipendentiTrasferiti |

element Detrazioni_Canoni_Locazione_Type/InquiliniAbitazionePrincipale

| | |
|-----------|---|
| diagram | |
| namespace | urn:www.agenziaentrate.gov.it:specificheTecniche:sco:730 |
| type | m730:Inquilini_Abitazione_Principale_Type |
| children | m730:Tipologia m730:GiorniPercentuale |

element **Detrazioni_Canoni_Locazione_Type/DipendentiTrasferiti**

| | |
|-----------|--|
| diagram | |
| namespace | urn:www.agenziaentrate.gov.it:specificheTecniche:sco:730 |
| type | m730:Giorni_Percentuale_Type |
| children | m730:Giorni m730:Percentuale |

complexType **Detrazioni_Modulo_Type**

| | |
|-----------|--|
| diagram | |
| namespace | urn:www.agenziaentrate.gov.it:specificheTecniche:sco:730 |
| children | m730:VeicoliDisabili m730:AcquistoCaniGuida m730:SpeseRateizzate m730:AltreSpese |

element **Detrazioni_Modulo_Type/VeicoliDisabili**

| | |
|-----------|--|
| diagram | |
| namespace | urn:www.agenziaentrate.gov.it:specificheTecniche:sco:730 |
| type | m730:Spese_Rateizzate_Type |
| children | m730:Codice m730:Importo |

element **Detrazioni_Modulo_Type/AcquistoCaniGuida**

| | |
|-----------|--|
| diagram | |
| namespace | urn:www.agenziaentrate.gov.it:specificheTecniche:sco:730 |
| type | m730:Spese_Rateizzate_Type |
| children | m730:Codice m730:Importo |

element **Detrazioni_Modulo_Type/SpeseRateizzate**

| | |
|-----------|--|
| diagram | |
| namespace | urn:www.agenziaentrate.gov.it:specificheTecniche:sco:730 |
| type | m730:Spese_Rateizzate_Anni_Precedenti_Type |
| children | m730:Codice m730:Importo |

element **Detrazioni_Modulo_Type/AltreSpese**

| | |
|-----------|--|
| diagram | |
| namespace | urn:www.agenziaentrate.gov.it:specificheTecniche:sco:730 |
| type | m730:Altre_Spese_Type |
| children | m730:Codice m730:Importo |

complexType **Detrazioni_Type**

| | |
|-----------|---|
| diagram | |
| namespace | urn:www.agenziaentrate.gov.it:specificheTecniche:sco:730 |
| children | m730:CasellaRateazione m730:SpeseDeterminatePatologie m730:SpeseSanitarie m730:SpeseFamNonACarico m730:SpeseSanitarieDisabili m730:VeicoliDisabili m730:AcquistoCaniGuida m730:SpeseRateizzate m730:MutuiAbPrincipale m730:AltreSpese |

element **Detrazioni_Type/CasellaRateazione**

| diagram | | | | | |
|-----------|---|------|-------|---------|------|
| namespace | urn:www.agenziaentrate.gov.it:specificheTecniche:sco:730 | | | | |
| type | DatoCB_Type | | | | |
| facets | <table border="1"> <thead> <tr> <th>Kind</th> <th>Value</th> </tr> </thead> <tbody> <tr> <td>pattern</td> <td>[01]</td> </tr> </tbody> </table> | Kind | Value | pattern | [01] |
| Kind | Value | | | | |
| pattern | [01] | | | | |

element **Detrazioni_Type/SpeseDeterminatePatologie**

| diagram | | | | | |
|-----------|---|------|-------|---------|----------------|
| namespace | urn:www.agenziaentrate.gov.it:specificheTecniche:sco:730 | | | | |
| type | DatoNP_Type | | | | |
| facets | <table border="1"> <thead> <tr> <th>Kind</th> <th>Value</th> </tr> </thead> <tbody> <tr> <td>pattern</td> <td>[1-9]{1}[0-9]*</td> </tr> </tbody> </table> | Kind | Value | pattern | [1-9]{1}[0-9]* |
| Kind | Value | | | | |
| pattern | [1-9]{1}[0-9]* | | | | |

element Detrazioni_Type/SpeseSanitarie

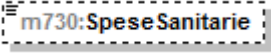
| | |
|-----------|---|
| diagram |  |
| namespace | urn:www.agenziaentrate.gov.it:specificheTecniche:sco:730 |
| type | DatoNP_Type |
| facets | Kind Value pattern [1-9]{1}[0-9]* |

element Detrazioni_Type/SpeseFamNonACarico

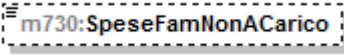
| | |
|-----------|---|
| diagram |  |
| namespace | urn:www.agenziaentrate.gov.it:specificheTecniche:sco:730 |
| type | DatoNP_Type |
| facets | Kind Value pattern [1-9]{1}[0-9]* |

element Detrazioni_Type/SpeseSanitarieDisabili

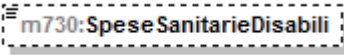
| | |
|-----------|---|
| diagram |  |
| namespace | urn:www.agenziaentrate.gov.it:specificheTecniche:sco:730 |
| type | DatoNP_Type |
| facets | Kind Value pattern [1-9]{1}[0-9]* |

element Detrazioni_Type/VeicoliDisabili

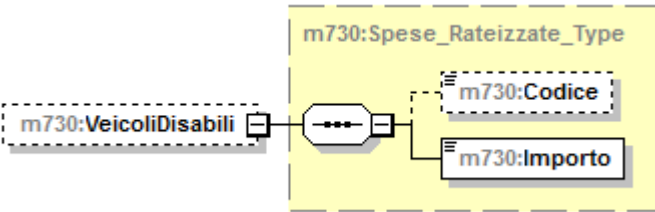
| | |
|-----------|---|
| diagram |  |
| namespace | urn:www.agenziaentrate.gov.it:specificheTecniche:sco:730 |
| type | m730:Spese_Rateizzate_Type |
| children | m730:Codice m730:Importo |

element Detrazioni_Type/AcquistoCaniGuida

| | |
|-----------|--|
| diagram | |
| namespace | urn:www.agenziaentrate.gov.it:specificheTecniche:sco:730 |
| type | m730:Spese_Rateizzate_Type |
| children | m730:Codice m730:Importo |

element Detrazioni_Type/SpeseRateizzate

| | |
|-----------|--|
| diagram | |
| namespace | urn:www.agenziaentrate.gov.it:specificheTecniche:sco:730 |
| type | m730:Spese_Rateizzate_Anni_Precedenti_Type |
| children | m730:Codice m730:Importo |

element Detrazioni_Type/MutuiAbPrincipale

| diagram | | | | | |
|-----------|---|------|-------|---------|----------------|
| namespace | urn:www.agenziaentrate.gov.it:specificheTecniche:sco:730 | | | | |
| type | DatoNP_Type | | | | |
| facets | <table border="1"> <thead> <tr> <th>Kind</th> <th>Value</th> </tr> </thead> <tbody> <tr> <td>pattern</td> <td>[1-9]{1}[0-9]*</td> </tr> </tbody> </table> | Kind | Value | pattern | [1-9]{1}[0-9]* |
| Kind | Value | | | | |
| pattern | [1-9]{1}[0-9]* | | | | |

element Detrazioni_Type/AltreSpese

| | |
|-----------|--|
| diagram | |
| namespace | urn:www.agenziaentrate.gov.it:specificheTecniche:sco:730 |
| type | m730:Altre_Spese_Type |

| | |
|----------|--|
| children | m730:Codice m730:Importo |
|----------|--|

complexType Documento_P73_Type

| | |
|-----------|--|
| diagram | |
| namespace | urn:www.agenziaentrate.gov.it:specificheTecniche:sco:730 |
| children | m730:Frontespizio m730:DatiContabili |

element Documento_P73_Type/Frontespizio

| | |
|-----------|--|
| diagram | |
| namespace | urn:www.agenziaentrate.gov.it:specificheTecniche:sco:730 |
| type | m730:Frontespizio_730_Type |
| children | m730:SoggettoFiscale m730:DatiAnagrafici m730:DomicilioFiscale01012014 m730:DomicilioFiscale01012015 m730:CasiParticolariAddizionale |

element **Documento_P73_Type/DatiContabili**

| | |
|------------------|---|
| <p>diagram</p> | |
| <p>namespace</p> | <p>urn:www.agenziaentrate.gov.it:specificheTecniche:sco:730</p> |
| <p>type</p> | <p>m730:Dati_Contabili_Type</p> |
| <p>children</p> | <p>m730:Familiari m730:QuadroA m730:QuadroB m730:QuadroC m730:QuadroD m730:QuadroE m730:QuadroF m730:QuadroG m730:ProspettoLiquidazione</p> |

complexType **Domicilio_Fiscale_type**

| | |
|------------------|---|
| <p>diagram</p> | |
| <p>namespace</p> | <p>urn:www.agenziaentrate.gov.it:specificheTecniche:sco:730</p> |
| <p>children</p> | <p>m730:Comune m730:Provincia m730:CodiceComune</p> |

element **Domicilio_Fiscale_type/Comune**

| | | | | | |
|------------------|--|------|-------|---------|---|
| <p>diagram</p> | | | | | |
| <p>namespace</p> | <p>urn:www.agenziaentrate.gov.it:specificheTecniche:sco:730</p> | | | | |
| <p>type</p> | <p>DatoAN_Type</p> | | | | |
| <p>facets</p> | <table border="0"> <tr> <td>Kind</td> <td>Value</td> </tr> <tr> <td>pattern</td> <td>([0-9A-Z-] \&quot;){1}([0-9A-Z&amp;] '\- \., / * \^\(\ \)\ À É È Ì Ò Ù Ü &quot; \ \\ \+)*</td> </tr> </table> | Kind | Value | pattern | ([0-9A-Z-] \"){1}([0-9A-Z&] '\- \., / * \^\(\ \)\ À É È Ì Ò Ù Ü " \ \\ \+)* |
| Kind | Value | | | | |
| pattern | ([0-9A-Z-] \"){1}([0-9A-Z&] '\- \., / * \^\(\ \)\ À É È Ì Ò Ù Ü " \ \\ \+)* | | | | |

element **Domicilio_Fiscale_type/Provincia**

| | |
|-----------|--|
| diagram | |
| namespace | urn:www.agenziaentrate.gov.it:specificheTecniche:sco:730 |
| type | PR_Type |

element **Domicilio_Fiscale_type/CodiceComune**

| | |
|-----------|--|
| diagram | |
| namespace | urn:www.agenziaentrate.gov.it:specificheTecniche:sco:730 |
| type | DatoAN_Type |
| facets | Kind Value pattern ([0-9A-Z- "}{1}{[0-9A-Z&] ' \\- \\. / ° \\^\\(\\ \\)\\À É È Ì Ò Ù Ú " \\ \\ \\+)* |

complexType **Eccedenze_Type**

| | |
|-----------|--|
| diagram | |
| namespace | urn:www.agenziaentrate.gov.it:specificheTecniche:sco:730 |
| children | m730:lrpéf m730:lrpéfCompF24 m730:SostitutivaQuadroRT m730:SostitutivaQuadroRTcompF24 m730:CedolareSecca m730:CedolareSeccaCompF24 m730:CodiceRegione m730:AddRegionalelrpéf m730:AddRegionalelrpéfCompF24 m730:CodiceCatastaleComune m730:AddComunalelrpéf m730:AddComunalelrpéfF24 |

element **Eccedenze_Type/lrpef**

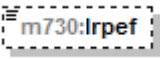
| | |
|-----------|---|
| diagram |  |
| namespace | urn:www.agenziaentrate.gov.it:specificheTecniche:sco:730 |
| type | DatoNP_Type |
| facets | Kind Value pattern [1-9]{1}[0-9]* |

element **Eccedenze_Type/lrpefCompF24**

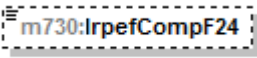
| | |
|-----------|---|
| diagram |  |
| namespace | urn:www.agenziaentrate.gov.it:specificheTecniche:sco:730 |
| type | DatoNP_Type |
| facets | Kind Value pattern [1-9]{1}[0-9]* |

element **Eccedenze_Type/SostitutivaQuadroRT**

| | |
|-----------|--|
| diagram |  |
| namespace | urn:www.agenziaentrate.gov.it:specificheTecniche:sco:730 |
| type | DatoNP_Type |
| facets | Kind Value pattern [1-9]{1}[0-9]* |

element **Eccedenze_Type/SostitutivaQuadroRTcompF24**

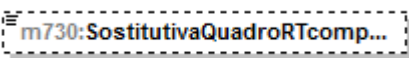
| | |
|-----------|---|
| diagram |  |
| namespace | urn:www.agenziaentrate.gov.it:specificheTecniche:sco:730 |
| type | DatoNP_Type |
| facets | Kind Value pattern [1-9]{1}[0-9]* |

element **Eccedenze_Type/CedolareSecca**

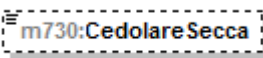
| | |
|-----------|---|
| diagram |  |
| namespace | urn:www.agenziaentrate.gov.it:specificheTecniche:sco:730 |
| type | DatoNP_Type |
| facets | Kind Value pattern [1-9]{1}[0-9]* |

element Eccedenze_Type/CedolareSeccaCompF24

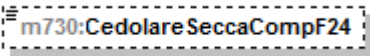
| diagram |  | | | | |
|-----------|---|------|-------|---------|----------------|
| namespace | urn:www.agenziaentrate.gov.it:specificheTecniche:sco:730 | | | | |
| type | DatoNP_Type | | | | |
| facets | <table border="1"> <thead> <tr> <th>Kind</th> <th>Value</th> </tr> </thead> <tbody> <tr> <td>pattern</td> <td>[1-9]{1}[0-9]*</td> </tr> </tbody> </table> | Kind | Value | pattern | [1-9]{1}[0-9]* |
| Kind | Value | | | | |
| pattern | [1-9]{1}[0-9]* | | | | |

element Eccedenze_Type/CodiceRegione

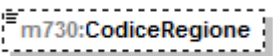
| diagram |  | | | | | | | | | | | | | | | | | | | | | | | | | | | | | | | | | | | | | | | | | | | | | | |
|-------------|---|------|-------|---------|--|-------------|---|-------------|---|-------------|---|-------------|---|-------------|---|-------------|---|-------------|---|-------------|---|-------------|---|-------------|----|-------------|----|-------------|----|-------------|----|-------------|----|-------------|----|-------------|----|-------------|----|-------------|----|-------------|----|-------------|----|-------------|----|
| namespace | urn:www.agenziaentrate.gov.it:specificheTecniche:sco:730 | | | | | | | | | | | | | | | | | | | | | | | | | | | | | | | | | | | | | | | | | | | | | | |
| type | Codice_Regione_Type | | | | | | | | | | | | | | | | | | | | | | | | | | | | | | | | | | | | | | | | | | | | | | |
| facets | <table border="1"> <thead> <tr> <th>Kind</th> <th>Value</th> </tr> </thead> <tbody> <tr> <td>pattern</td> <td>([0-9A-Z\-\-]&quot;){1}([0-9A-Z&amp;:] ' \- \., /° ^\(\\)\) À È É Ì Ò Ù Ü &quot; \\ / +)*</td> </tr> <tr><td>enumeration</td><td>1</td></tr> <tr><td>enumeration</td><td>2</td></tr> <tr><td>enumeration</td><td>3</td></tr> <tr><td>enumeration</td><td>4</td></tr> <tr><td>enumeration</td><td>5</td></tr> <tr><td>enumeration</td><td>6</td></tr> <tr><td>enumeration</td><td>7</td></tr> <tr><td>enumeration</td><td>8</td></tr> <tr><td>enumeration</td><td>9</td></tr> <tr><td>enumeration</td><td>10</td></tr> <tr><td>enumeration</td><td>11</td></tr> <tr><td>enumeration</td><td>12</td></tr> <tr><td>enumeration</td><td>13</td></tr> <tr><td>enumeration</td><td>14</td></tr> <tr><td>enumeration</td><td>15</td></tr> <tr><td>enumeration</td><td>16</td></tr> <tr><td>enumeration</td><td>17</td></tr> <tr><td>enumeration</td><td>18</td></tr> <tr><td>enumeration</td><td>19</td></tr> <tr><td>enumeration</td><td>20</td></tr> <tr><td>enumeration</td><td>21</td></tr> </tbody> </table> | Kind | Value | pattern | ([0-9A-Z\-\-]"){1}([0-9A-Z&:] ' \- \., /° ^\(\\)\) À È É Ì Ò Ù Ü " \\ / +)* | enumeration | 1 | enumeration | 2 | enumeration | 3 | enumeration | 4 | enumeration | 5 | enumeration | 6 | enumeration | 7 | enumeration | 8 | enumeration | 9 | enumeration | 10 | enumeration | 11 | enumeration | 12 | enumeration | 13 | enumeration | 14 | enumeration | 15 | enumeration | 16 | enumeration | 17 | enumeration | 18 | enumeration | 19 | enumeration | 20 | enumeration | 21 |
| Kind | Value | | | | | | | | | | | | | | | | | | | | | | | | | | | | | | | | | | | | | | | | | | | | | | |
| pattern | ([0-9A-Z\-\-]"){1}([0-9A-Z&:] ' \- \., /° ^\(\\)\) À È É Ì Ò Ù Ü " \\ / +)* | | | | | | | | | | | | | | | | | | | | | | | | | | | | | | | | | | | | | | | | | | | | | | |
| enumeration | 1 | | | | | | | | | | | | | | | | | | | | | | | | | | | | | | | | | | | | | | | | | | | | | | |
| enumeration | 2 | | | | | | | | | | | | | | | | | | | | | | | | | | | | | | | | | | | | | | | | | | | | | | |
| enumeration | 3 | | | | | | | | | | | | | | | | | | | | | | | | | | | | | | | | | | | | | | | | | | | | | | |
| enumeration | 4 | | | | | | | | | | | | | | | | | | | | | | | | | | | | | | | | | | | | | | | | | | | | | | |
| enumeration | 5 | | | | | | | | | | | | | | | | | | | | | | | | | | | | | | | | | | | | | | | | | | | | | | |
| enumeration | 6 | | | | | | | | | | | | | | | | | | | | | | | | | | | | | | | | | | | | | | | | | | | | | | |
| enumeration | 7 | | | | | | | | | | | | | | | | | | | | | | | | | | | | | | | | | | | | | | | | | | | | | | |
| enumeration | 8 | | | | | | | | | | | | | | | | | | | | | | | | | | | | | | | | | | | | | | | | | | | | | | |
| enumeration | 9 | | | | | | | | | | | | | | | | | | | | | | | | | | | | | | | | | | | | | | | | | | | | | | |
| enumeration | 10 | | | | | | | | | | | | | | | | | | | | | | | | | | | | | | | | | | | | | | | | | | | | | | |
| enumeration | 11 | | | | | | | | | | | | | | | | | | | | | | | | | | | | | | | | | | | | | | | | | | | | | | |
| enumeration | 12 | | | | | | | | | | | | | | | | | | | | | | | | | | | | | | | | | | | | | | | | | | | | | | |
| enumeration | 13 | | | | | | | | | | | | | | | | | | | | | | | | | | | | | | | | | | | | | | | | | | | | | | |
| enumeration | 14 | | | | | | | | | | | | | | | | | | | | | | | | | | | | | | | | | | | | | | | | | | | | | | |
| enumeration | 15 | | | | | | | | | | | | | | | | | | | | | | | | | | | | | | | | | | | | | | | | | | | | | | |
| enumeration | 16 | | | | | | | | | | | | | | | | | | | | | | | | | | | | | | | | | | | | | | | | | | | | | | |
| enumeration | 17 | | | | | | | | | | | | | | | | | | | | | | | | | | | | | | | | | | | | | | | | | | | | | | |
| enumeration | 18 | | | | | | | | | | | | | | | | | | | | | | | | | | | | | | | | | | | | | | | | | | | | | | |
| enumeration | 19 | | | | | | | | | | | | | | | | | | | | | | | | | | | | | | | | | | | | | | | | | | | | | | |
| enumeration | 20 | | | | | | | | | | | | | | | | | | | | | | | | | | | | | | | | | | | | | | | | | | | | | | |
| enumeration | 21 | | | | | | | | | | | | | | | | | | | | | | | | | | | | | | | | | | | | | | | | | | | | | | |

element Eccedenze_Type/AddRegionalelrpef

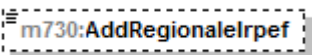
| diagram |  | | | | |
|-----------|---|------|-------|---------|----------------|
| namespace | urn:www.agenziaentrate.gov.it:specificheTecniche:sco:730 | | | | |
| type | DatoNP_Type | | | | |
| facets | <table border="1"> <thead> <tr> <th>Kind</th> <th>Value</th> </tr> </thead> <tbody> <tr> <td>pattern</td> <td>[1-9]{1}[0-9]*</td> </tr> </tbody> </table> | Kind | Value | pattern | [1-9]{1}[0-9]* |
| Kind | Value | | | | |
| pattern | [1-9]{1}[0-9]* | | | | |

element **Eccedenze_Type/AddRegionalelrpefCompF24**

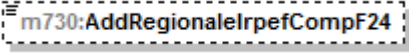
| | |
|-----------|---|
| diagram |  |
| namespace | urn:www.agenziaentrate.gov.it:specificheTecniche:sco:730 |
| type | DatoNP_Type |
| facets | Kind Value pattern [1-9]{1}[0-9]* |

element **Eccedenze_Type/CodiceCatastaleComune**

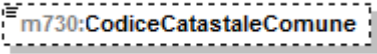
| | |
|-----------|---|
| diagram |  |
| namespace | urn:www.agenziaentrate.gov.it:specificheTecniche:sco:730 |
| type | restriction of DatoAN_Type |
| facets | Kind Value pattern ([0-9A-Z\-\]"){1}([0-9A-Z&:] \- \., / \° \^ \(\) \À \É \È \Ì \Ò \Ù \Ü "; \\ / \+)* |

element **Eccedenze_Type/AddComunalelrpef**

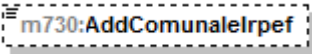
| | |
|-----------|---|
| diagram |  |
| namespace | urn:www.agenziaentrate.gov.it:specificheTecniche:sco:730 |
| type | DatoNP_Type |
| facets | Kind Value pattern [1-9]{1}[0-9]* |

element **Eccedenze_Type/AddComunalelrpefF24**

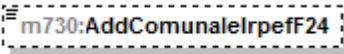
| | |
|-----------|---|
| diagram |  |
| namespace | urn:www.agenziaentrate.gov.it:specificheTecniche:sco:730 |
| type | DatoNP_Type |
| facets | Kind Value pattern [1-9]{1}[0-9]* |

complexType **Elemento_Integrativo_Type**

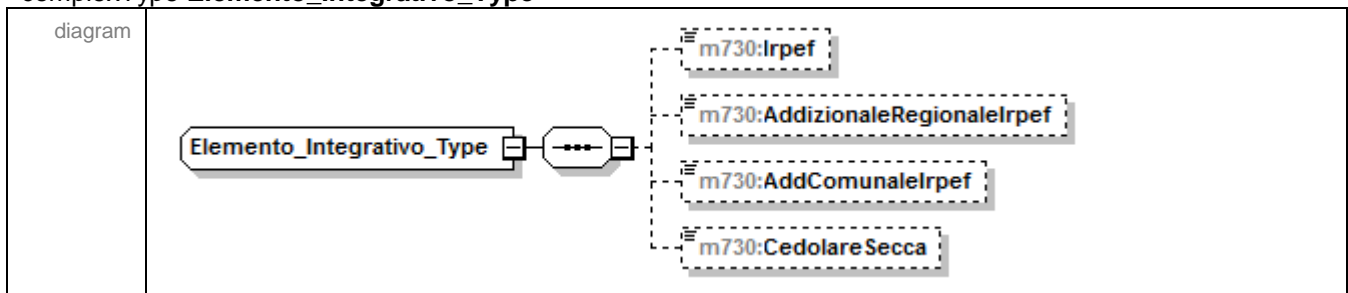

| | |
|-----------|--|
| namespace | urn:www.agenziaentrate.gov.it:specificheTecniche:sco:730 |
| children | m730:Irpef m730:AddizionaleRegionaleIrpef m730:AddComunaleIrpef m730:CedolareSecca |

element Elemento_Integrativo_Type/Irpef

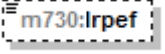
| | | | | | |
|-----------|---|------|-------|---------|----------------|
| diagram |  | | | | |
| namespace | urn:www.agenziaentrate.gov.it:specificheTecniche:sco:730 | | | | |
| type | DatoNP_Type | | | | |
| facets | <table border="0"> <tr> <td>Kind</td> <td>Value</td> </tr> <tr> <td>pattern</td> <td>[1-9]{1}[0-9]*</td> </tr> </table> | Kind | Value | pattern | [1-9]{1}[0-9]* |
| Kind | Value | | | | |
| pattern | [1-9]{1}[0-9]* | | | | |

element Elemento_Integrativo_Type/AddizionaleRegionaleIrpef

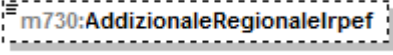
| | | | | | |
|-----------|---|------|-------|---------|----------------|
| diagram |  | | | | |
| namespace | urn:www.agenziaentrate.gov.it:specificheTecniche:sco:730 | | | | |
| type | DatoNP_Type | | | | |
| facets | <table border="0"> <tr> <td>Kind</td> <td>Value</td> </tr> <tr> <td>pattern</td> <td>[1-9]{1}[0-9]*</td> </tr> </table> | Kind | Value | pattern | [1-9]{1}[0-9]* |
| Kind | Value | | | | |
| pattern | [1-9]{1}[0-9]* | | | | |

element Elemento_Integrativo_Type/AddComunaleIrpef

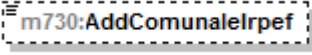
| | | | | | |
|-----------|---|------|-------|---------|----------------|
| diagram |  | | | | |
| namespace | urn:www.agenziaentrate.gov.it:specificheTecniche:sco:730 | | | | |
| type | DatoNP_Type | | | | |
| facets | <table border="0"> <tr> <td>Kind</td> <td>Value</td> </tr> <tr> <td>pattern</td> <td>[1-9]{1}[0-9]*</td> </tr> </table> | Kind | Value | pattern | [1-9]{1}[0-9]* |
| Kind | Value | | | | |
| pattern | [1-9]{1}[0-9]* | | | | |

element Elemento_Integrativo_Type/CedolareSecca

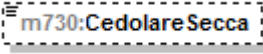
| | | | | | |
|-----------|---|------|-------|---------|----------------|
| diagram |  | | | | |
| namespace | urn:www.agenziaentrate.gov.it:specificheTecniche:sco:730 | | | | |
| type | DatoNP_Type | | | | |
| facets | <table border="0"> <tr> <td>Kind</td> <td>Value</td> </tr> <tr> <td>pattern</td> <td>[1-9]{1}[0-9]*</td> </tr> </table> | Kind | Value | pattern | [1-9]{1}[0-9]* |
| Kind | Value | | | | |
| pattern | [1-9]{1}[0-9]* | | | | |

complexType Esenzione_Add_Comunale_Type

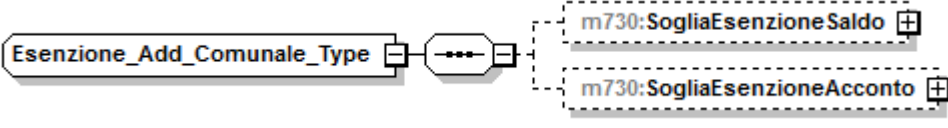
| | |
|-----------|---|
| diagram |  |
| namespace | urn:www.agenziaentrate.gov.it:specificheTecniche:sco:730 |
| children | m730:SogliaEsenzioneSaldo m730:SogliaEsenzioneAcconto |

element Esenzione_Add_Comunale_Type/SogliaEsenzioneSaldo

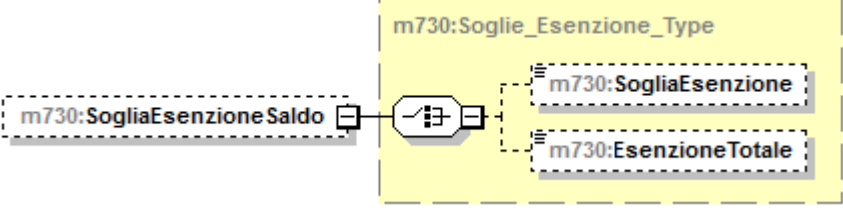
| | |
|-----------|--|
| diagram |  |
| namespace | urn:www.agenziaentrate.gov.it:specificheTecniche:sco:730 |
| type | m730:Soglie_Esenzione_Type |
| children | m730:SogliaEsenzione m730:EsenzioneTotale |

element Esenzione_Add_Comunale_Type/SogliaEsenzioneAcconto

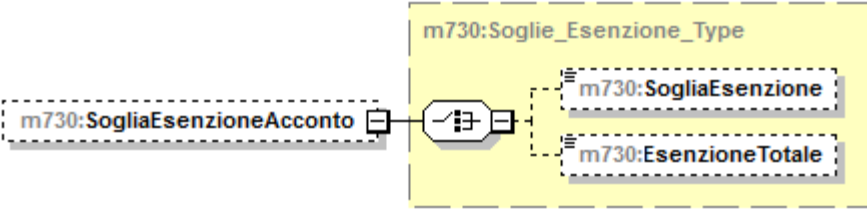
| | |
|-----------|--|
| diagram |  |
| namespace | urn:www.agenziaentrate.gov.it:specificheTecniche:sco:730 |
| type | m730:Soglie_Esenzione_Type |
| children | m730:SogliaEsenzione m730:EsenzioneTotale |

complexType Esito_Liquidazione_Type

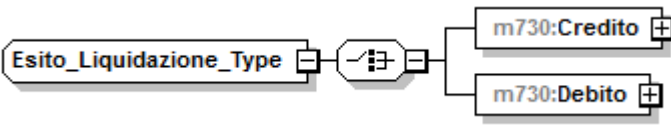
| | |
|-----------|---|
| diagram |  |
| namespace | urn:www.agenziaentrate.gov.it:specificheTecniche:sco:730 |
| children | m730:Credito m730:Debito |

element **Esito_Liquidazione_Type/Credito**

| | |
|-----------|--|
| diagram | <p>The diagram shows a box labeled 'm730:Credito_Type' with a dashed border. To its left is a box labeled 'm730:Credito'. A line connects 'm730:Credito' to a central connector box. From this connector, four dashed lines branch out to boxes labeled 'm730:NonRimborsabile', 'm730:Credito', 'm730:CreditoF24', and 'm730:CreditoRimborso'.</p> |
| namespace | urn:www.agenziaentrate.gov.it:specificheTecniche:sco:730 |
| type | m730:Credito_Type |
| children | m730:NonRimborsabile m730:Credito m730:CreditoF24 m730:CreditoRimborso |

element **Esito_Liquidazione_Type/Debito**

| | |
|-----------|---|
| diagram | <p>The diagram shows a box labeled 'm730:Debito_Type' with a dashed border. To its left is a box labeled 'm730:Debito'. A line connects 'm730:Debito' to a central connector box. From this connector, two dashed lines branch out to boxes labeled 'm730:NonVersare' and 'm730:ImportoDaTrattenere'.</p> |
| namespace | urn:www.agenziaentrate.gov.it:specificheTecniche:sco:730 |
| type | m730:Debito_Type |
| children | m730:NonVersare m730:ImportoDaTrattenere |

complexType **FabbricatoAgev_Type**

| | |
|-----------|--|
| diagram | <p>The diagram shows a box labeled 'FabbricatoAgev_Type' with a dashed border. To its right is a central connector box. From this connector, six dashed lines branch out to boxes labeled 'm730:NumeroRigoRiferimento', 'm730:NumModuloRiferimento', 'm730:DatiContratto' (with a plus sign icon), 'm730:CasellaInf30Giorni', 'm730:AnnoDichiarazioneIcilmu', and 'm730:StatoEmergenza'.</p> |
| namespace | urn:www.agenziaentrate.gov.it:specificheTecniche:sco:730 |
| children | m730:NumeroRigoRiferimento m730:NumModuloRiferimento m730:DatiContratto m730:CasellaInf30Giorni m730:AnnoDichiarazioneIcilmu m730:StatoEmergenza |

element FabbricatoAgev_Type/NumeroRigoRiferimento

| | | | | | | | | | | | | | | | | | | | | | | | | | |
|-------------|--|------|-------|---------|----------------|-------------|---|-------------|---|-------------|---|-------------|---|-------------|---|-------------|---|-------------|---|-------------|---|-------------|---|-------------|----|
| diagram |  | | | | | | | | | | | | | | | | | | | | | | | | |
| namespace | urn:www.agenziaentrate.gov.it:specificheTecniche:sco:730 | | | | | | | | | | | | | | | | | | | | | | | | |
| type | m730:FabbricatoAgev Numero Rigo Type | | | | | | | | | | | | | | | | | | | | | | | | |
| facets | <table border="0"> <tr> <td>Kind</td> <td>Value</td> </tr> <tr> <td>pattern</td> <td>[1-9]{1}[0-9]*</td> </tr> <tr> <td>enumeration</td> <td>1</td> </tr> <tr> <td>enumeration</td> <td>2</td> </tr> <tr> <td>enumeration</td> <td>3</td> </tr> <tr> <td>enumeration</td> <td>4</td> </tr> <tr> <td>enumeration</td> <td>5</td> </tr> <tr> <td>enumeration</td> <td>6</td> </tr> <tr> <td>enumeration</td> <td>7</td> </tr> <tr> <td>enumeration</td> <td>8</td> </tr> <tr> <td>enumeration</td> <td>9</td> </tr> <tr> <td>enumeration</td> <td>10</td> </tr> </table> | Kind | Value | pattern | [1-9]{1}[0-9]* | enumeration | 1 | enumeration | 2 | enumeration | 3 | enumeration | 4 | enumeration | 5 | enumeration | 6 | enumeration | 7 | enumeration | 8 | enumeration | 9 | enumeration | 10 |
| Kind | Value | | | | | | | | | | | | | | | | | | | | | | | | |
| pattern | [1-9]{1}[0-9]* | | | | | | | | | | | | | | | | | | | | | | | | |
| enumeration | 1 | | | | | | | | | | | | | | | | | | | | | | | | |
| enumeration | 2 | | | | | | | | | | | | | | | | | | | | | | | | |
| enumeration | 3 | | | | | | | | | | | | | | | | | | | | | | | | |
| enumeration | 4 | | | | | | | | | | | | | | | | | | | | | | | | |
| enumeration | 5 | | | | | | | | | | | | | | | | | | | | | | | | |
| enumeration | 6 | | | | | | | | | | | | | | | | | | | | | | | | |
| enumeration | 7 | | | | | | | | | | | | | | | | | | | | | | | | |
| enumeration | 8 | | | | | | | | | | | | | | | | | | | | | | | | |
| enumeration | 9 | | | | | | | | | | | | | | | | | | | | | | | | |
| enumeration | 10 | | | | | | | | | | | | | | | | | | | | | | | | |

element FabbricatoAgev_Type/NumModuloRiferimento

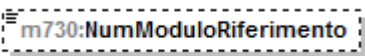
| | | | | | |
|-----------|---|------|-------|---------|----------------|
| diagram |  | | | | |
| namespace | urn:www.agenziaentrate.gov.it:specificheTecniche:sco:730 | | | | |
| type | DatoNP Type | | | | |
| facets | <table border="0"> <tr> <td>Kind</td> <td>Value</td> </tr> <tr> <td>pattern</td> <td>[1-9]{1}[0-9]*</td> </tr> </table> | Kind | Value | pattern | [1-9]{1}[0-9]* |
| Kind | Value | | | | |
| pattern | [1-9]{1}[0-9]* | | | | |

element FabbricatoAgev_Type/DatiContratto

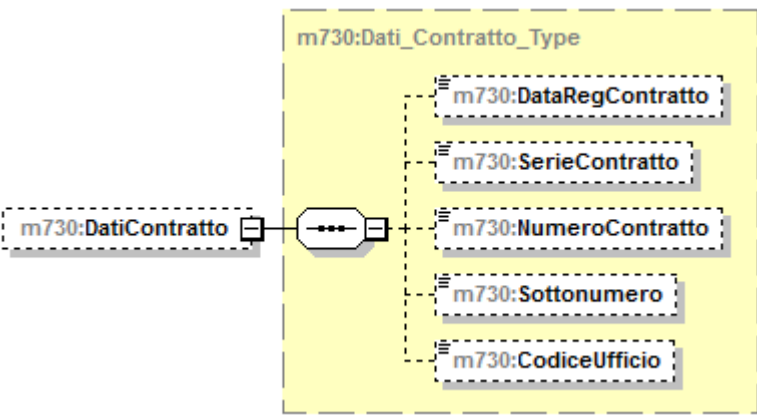
| | |
|-----------|--|
| diagram |  |
| namespace | urn:www.agenziaentrate.gov.it:specificheTecniche:sco:730 |
| type | m730:Dati_Contratto_Type |
| children | m730:DataRegContratto m730:SerieContratto m730:NumeroContratto m730:Sottonumero m730:CodiceUfficio |

element FabbricatoAgev_Type/CasellaInf30Giorni

| | |
|-----------|---|
| diagram |  m730:CasellaInf30Giorni |
| namespace | urn:www.agenziaentrate.gov.it:specificheTecniche:sco:730 |
| type | DatoCB_Type |
| facets | Kind Value pattern [01] |

element FabbricatoAgev_Type/AnnoDichiarazioneIcilmu

| | |
|-----------|--|
| diagram |  m730:AnnoDichiarazioneIcilmu |
| namespace | urn:www.agenziaentrate.gov.it:specificheTecniche:sco:730 |
| type | DatoDA_Type |
| facets | Kind Value pattern (18 19 20)[0-9]{2} |

element FabbricatoAgev_Type/StatoEmergenza

| | |
|-----------|---|
| diagram |  m730:StatoEmergenza |
| namespace | urn:www.agenziaentrate.gov.it:specificheTecniche:sco:730 |
| type | DatoCB_Type |
| facets | Kind Value pattern [01] |

complexType **FabbricatoOrd_Type**

| | |
|-----------|---|
| diagram | |
| namespace | urn:www.agenziaentrate.gov.it:specificheTecniche:sco:730 |
| children | m730:Rendita m730:Utilizzo m730:GiorniPossesso m730:PercPossesso m730:CodiceCanone m730:CanoneLocazione m730:CasiParticolari m730:CasellaContinuazione m730:CodiceComune m730:OpzioneCedolare m730:CasellaCasiPartimu |

element **FabbricatoOrd_Type/Rendita**

| | | | | | |
|-----------|---|------|-------|---------|----------------|
| diagram | | | | | |
| namespace | urn:www.agenziaentrate.gov.it:specificheTecniche:sco:730 | | | | |
| type | DatoNP_Type | | | | |
| facets | <table border="0"> <tr> <td>Kind</td> <td>Value</td> </tr> <tr> <td>pattern</td> <td>[1-9]{1}[0-9]*</td> </tr> </table> | Kind | Value | pattern | [1-9]{1}[0-9]* |
| Kind | Value | | | | |
| pattern | [1-9]{1}[0-9]* | | | | |

element **FabbricatoOrd_Type/Utilizzo**

| | | | | | | | | | | | | | |
|-------------|---|------|-------|---------|----------------|-------------|---|-------------|---|-------------|---|-------------|---|
| diagram | | | | | | | | | | | | | |
| namespace | urn:www.agenziaentrate.gov.it:specificheTecniche:sco:730 | | | | | | | | | | | | |
| type | restriction of m730:Utilizzo Fabbricato_Type | | | | | | | | | | | | |
| facets | <table border="0"> <tr> <td>Kind</td> <td>Value</td> </tr> <tr> <td>pattern</td> <td>[1-9]{1}[0-9]*</td> </tr> <tr> <td>enumeration</td> <td>1</td> </tr> <tr> <td>enumeration</td> <td>2</td> </tr> <tr> <td>enumeration</td> <td>3</td> </tr> <tr> <td>enumeration</td> <td>4</td> </tr> </table> | Kind | Value | pattern | [1-9]{1}[0-9]* | enumeration | 1 | enumeration | 2 | enumeration | 3 | enumeration | 4 |
| Kind | Value | | | | | | | | | | | | |
| pattern | [1-9]{1}[0-9]* | | | | | | | | | | | | |
| enumeration | 1 | | | | | | | | | | | | |
| enumeration | 2 | | | | | | | | | | | | |
| enumeration | 3 | | | | | | | | | | | | |
| enumeration | 4 | | | | | | | | | | | | |

| | |
|-------------|----|
| enumeration | 5 |
| enumeration | 8 |
| enumeration | 9 |
| enumeration | 10 |
| enumeration | 11 |
| enumeration | 12 |
| enumeration | 14 |
| enumeration | 15 |
| enumeration | 16 |
| enumeration | 17 |

element FabbricatoOrd_Type/GiorniPossesso

| diagram | | | | | |
|-----------|---|------|-------|---------|----------------|
| namespace | urn:www.agenziaentrate.gov.it:specificheTecniche:sco:730 | | | | |
| type | restriction of DatoNP_Type | | | | |
| facets | <table border="1"> <tr> <th>Kind</th> <th>Value</th> </tr> <tr> <td>pattern</td> <td>[1-9]{1}[0-9]*</td> </tr> </table> | Kind | Value | pattern | [1-9]{1}[0-9]* |
| Kind | Value | | | | |
| pattern | [1-9]{1}[0-9]* | | | | |

element FabbricatoOrd_Type/PercPossesso

| diagram | | | | | |
|-----------|---|------|-------|---------|--------------------------------------|
| namespace | urn:www.agenziaentrate.gov.it:specificheTecniche:sco:730 | | | | |
| type | DatoPC_Type | | | | |
| facets | <table border="1"> <tr> <th>Kind</th> <th>Value</th> </tr> <tr> <td>pattern</td> <td>[0-9]?[0-9](,\d{1,3})? 100,(0{1,3})?</td> </tr> </table> | Kind | Value | pattern | [0-9]?[0-9](,\d{1,3})? 100,(0{1,3})? |
| Kind | Value | | | | |
| pattern | [0-9]?[0-9](,\d{1,3})? 100,(0{1,3})? | | | | |

element FabbricatoOrd_Type/CodiceCanone

| diagram | | | | | | | | | | | | | |
|-------------|--|------|-------|---------|-------|-------------|---|-------------|---|-------------|---|-------------|---|
| namespace | urn:www.agenziaentrate.gov.it:specificheTecniche:sco:730 | | | | | | | | | | | | |
| type | m730:CodiceCanone_Type | | | | | | | | | | | | |
| facets | <table border="1"> <tr> <th>Kind</th> <th>Value</th> </tr> <tr> <td>pattern</td> <td>[1-9]</td> </tr> <tr> <td>enumeration</td> <td>1</td> </tr> <tr> <td>enumeration</td> <td>2</td> </tr> <tr> <td>enumeration</td> <td>3</td> </tr> <tr> <td>enumeration</td> <td>4</td> </tr> </table> | Kind | Value | pattern | [1-9] | enumeration | 1 | enumeration | 2 | enumeration | 3 | enumeration | 4 |
| Kind | Value | | | | | | | | | | | | |
| pattern | [1-9] | | | | | | | | | | | | |
| enumeration | 1 | | | | | | | | | | | | |
| enumeration | 2 | | | | | | | | | | | | |
| enumeration | 3 | | | | | | | | | | | | |
| enumeration | 4 | | | | | | | | | | | | |

element FabbricatoOrd_Type/CanoneLocazione

| diagram | | | | | |
|-----------|---|------|-------|---------|----------------|
| namespace | urn:www.agenziaentrate.gov.it:specificheTecniche:sco:730 | | | | |
| type | DatoNP_Type | | | | |
| facets | <table border="1"> <tr> <th>Kind</th> <th>Value</th> </tr> <tr> <td>pattern</td> <td>[1-9]{1}[0-9]*</td> </tr> </table> | Kind | Value | pattern | [1-9]{1}[0-9]* |
| Kind | Value | | | | |
| pattern | [1-9]{1}[0-9]* | | | | |

element FabbricatoOrd_Type/CasiParticolari

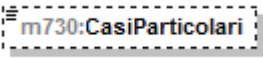
| diagram |  | | | | | | | | | | | | | | |
|-------------|---|------|-------|---------|-------|-------------|---|-------------|---|-------------|---|-------------|---|-------------|---|
| namespace | urn:www.agenziaentrate.gov.it:specificheTecniche:sco:730 | | | | | | | | | | | | | | |
| type | m730:CasiParticolariFabbricato_Type | | | | | | | | | | | | | | |
| facets | <table border="1"> <thead> <tr> <th>Kind</th> <th>Value</th> </tr> </thead> <tbody> <tr> <td>pattern</td> <td>[1-9]</td> </tr> <tr> <td>enumeration</td> <td>1</td> </tr> <tr> <td>enumeration</td> <td>3</td> </tr> <tr> <td>enumeration</td> <td>4</td> </tr> <tr> <td>enumeration</td> <td>5</td> </tr> <tr> <td>enumeration</td> <td>6</td> </tr> </tbody> </table> | Kind | Value | pattern | [1-9] | enumeration | 1 | enumeration | 3 | enumeration | 4 | enumeration | 5 | enumeration | 6 |
| Kind | Value | | | | | | | | | | | | | | |
| pattern | [1-9] | | | | | | | | | | | | | | |
| enumeration | 1 | | | | | | | | | | | | | | |
| enumeration | 3 | | | | | | | | | | | | | | |
| enumeration | 4 | | | | | | | | | | | | | | |
| enumeration | 5 | | | | | | | | | | | | | | |
| enumeration | 6 | | | | | | | | | | | | | | |

element FabbricatoOrd_Type/CasellaContinuazione

| diagram |  | | | | |
|-----------|---|------|-------|---------|------|
| namespace | urn:www.agenziaentrate.gov.it:specificheTecniche:sco:730 | | | | |
| type | DatoCB_Type | | | | |
| facets | <table border="1"> <thead> <tr> <th>Kind</th> <th>Value</th> </tr> </thead> <tbody> <tr> <td>pattern</td> <td>[01]</td> </tr> </tbody> </table> | Kind | Value | pattern | [01] |
| Kind | Value | | | | |
| pattern | [01] | | | | |

element FabbricatoOrd_Type/CodiceComune

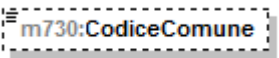
| diagram |  | | | | |
|-----------|---|------|-------|---------|--|
| namespace | urn:www.agenziaentrate.gov.it:specificheTecniche:sco:730 | | | | |
| type | restriction of DatoAN_Type | | | | |
| facets | <table border="1"> <thead> <tr> <th>Kind</th> <th>Value</th> </tr> </thead> <tbody> <tr> <td>pattern</td> <td>(([0-9A-Z\-\] \&quot;){1}){([0-9A-Z&amp;#92; \- \., / ^*\(\)\ À É È Ì Ò Ù Û &quot; \ \\ / +)*</td> </tr> </tbody> </table> | Kind | Value | pattern | (([0-9A-Z\-\] \"){1}){([0-9A-Z&#92; \- \., / ^*\(\)\ À É È Ì Ò Ù Û " \ \\ / +)* |
| Kind | Value | | | | |
| pattern | (([0-9A-Z\-\] \"){1}){([0-9A-Z&#92; \- \., / ^*\(\)\ À É È Ì Ò Ù Û " \ \\ / +)* | | | | |

element FabbricatoOrd_Type/OpzioneCedolare

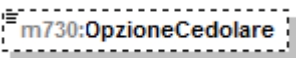
| diagram |  | | | | |
|-----------|---|------|-------|---------|------|
| namespace | urn:www.agenziaentrate.gov.it:specificheTecniche:sco:730 | | | | |
| type | DatoCB_Type | | | | |
| facets | <table border="1"> <thead> <tr> <th>Kind</th> <th>Value</th> </tr> </thead> <tbody> <tr> <td>pattern</td> <td>[01]</td> </tr> </tbody> </table> | Kind | Value | pattern | [01] |
| Kind | Value | | | | |
| pattern | [01] | | | | |

element FabbricatoOrd_Type/CasellaCasiPartImu

| | |
|---------|---|
| diagram |  |
|---------|---|

| | | | | | | | | | | | |
|-------------|---|------|-------|---------|-------|-------------|---|-------------|---|-------------|---|
| namespace | urn:www.agenziaentrate.gov.it:specificheTecniche:sco:730 | | | | | | | | | | |
| type | restriction of DatoN1_Type | | | | | | | | | | |
| facets | <table border="0"> <tr> <td>Kind</td> <td>Value</td> </tr> <tr> <td>pattern</td> <td>[1-9]</td> </tr> <tr> <td>enumeration</td> <td>1</td> </tr> <tr> <td>enumeration</td> <td>2</td> </tr> <tr> <td>enumeration</td> <td>3</td> </tr> </table> | Kind | Value | pattern | [1-9] | enumeration | 1 | enumeration | 2 | enumeration | 3 |
| Kind | Value | | | | | | | | | | |
| pattern | [1-9] | | | | | | | | | | |
| enumeration | 1 | | | | | | | | | | |
| enumeration | 2 | | | | | | | | | | |
| enumeration | 3 | | | | | | | | | | |

complexType Familiari_PrimoModulo_Type

| | |
|-----------|---|
| diagram | |
| namespace | urn:www.agenziaentrate.gov.it:specificheTecniche:sco:730 |
| children | m730:Coniuge m730:PrimoFiglio m730:Familiari m730:FigliResEsteri m730:PercUlteriore |

element Familiari_PrimoModulo_Type/Coniuge

| | |
|-----------|--|
| diagram | |
| namespace | urn:www.agenziaentrate.gov.it:specificheTecniche:sco:730 |
| type | m730:Dati_Coniuge_Type |
| children | m730:Tipo m730:CodiceFiscale m730:Mesi |

element **Familiari_PrimoModulo_Type/PrimoFiglio**

| | |
|------------------|---|
| <p>diagram</p> | <p>The diagram shows a class <code>m730:PrimoFiglio</code> extending <code>m730:Dati_Familiare_Type</code>. The extension is highlighted in a yellow dashed box and includes the following elements: <code>m730:CodiceFiscale</code>, <code>m730:Mes</code>, <code>m730:MesMinore</code>, <code>m730:PercDetraz</code>, <code>m730:PercDetrazCon</code>, <code>m730:Affidamento</code>, and <code>m730:Tipo</code>.</p> |
| <p>namespace</p> | <p>urn:www.agenziaentrate.gov.it:specificheTecniche:sco:730</p> |
| <p>type</p> | <p>extension of m730:Dati_Familiare_Type</p> |
| <p>children</p> | <p>m730:CodiceFiscale m730:Mes m730:MesMinore m730:PercDetraz m730:PercDetrazCon m730:Affidamento m730:Tipo</p> |

element **Familiari_PrimoModulo_Type/PrimoFiglio/Tipo**

| <p>diagram</p> | <p>The diagram shows a class <code>m730:Tipo</code> which is a restriction of <code>DatoAN_Type</code>.</p> | | | | | | | | |
|------------------|--|------|-------|---------|---|-------------|---|-------------|---|
| <p>namespace</p> | <p>urn:www.agenziaentrate.gov.it:specificheTecniche:sco:730</p> | | | | | | | | |
| <p>type</p> | <p>restriction of DatoAN_Type</p> | | | | | | | | |
| <p>facets</p> | <table border="1"> <thead> <tr> <th>Kind</th> <th>Value</th> </tr> </thead> <tbody> <tr> <td>pattern</td> <td>(([0-9A-Z-] &quot;){1}([0-9A-Z&amp;] ' -\. . \° ^\(\\) À É Ï Ò Ù Ü &quot; \\N \\+)*</td> </tr> <tr> <td>enumeration</td> <td>F</td> </tr> <tr> <td>enumeration</td> <td>D</td> </tr> </tbody> </table> | Kind | Value | pattern | (([0-9A-Z-] "){1}([0-9A-Z&] ' -\. . \° ^\(\\) À É Ï Ò Ù Ü " \\N \\+)* | enumeration | F | enumeration | D |
| Kind | Value | | | | | | | | |
| pattern | (([0-9A-Z-] "){1}([0-9A-Z&] ' -\. . \° ^\(\\) À É Ï Ò Ù Ü " \\N \\+)* | | | | | | | | |
| enumeration | F | | | | | | | | |
| enumeration | D | | | | | | | | |

element **Familiari_PrimoModulo_Type/Familiari**

| | |
|-----------|--|
| diagram | |
| namespace | urn:www.agenziaentrate.gov.it:specificheTecniche:sco:730 |
| type | extension of m730:Dati Familiare Type |
| children | m730:CodiceFiscale m730:Mesi m730:MesiMinore m730:PercDetraz m730:PercDetrazCon m730:Affidamento m730:Tipo |

element **Familiari_PrimoModulo_Type/Familiari/Tipo**

| diagram | | | | | | | | | | | |
|-------------|---|------|-------|---------|---|-------------|---|-------------|---|-------------|---|
| namespace | urn:www.agenziaentrate.gov.it:specificheTecniche:sco:730 | | | | | | | | | | |
| type | restriction of DatoAN Type | | | | | | | | | | |
| facets | <table border="1"> <thead> <tr> <th>Kind</th> <th>Value</th> </tr> </thead> <tbody> <tr> <td>pattern</td> <td>(([0-9A-Z-])&quot;){1}([0-9A-Z&amp;:] ' - \- . \./ ° \^ \(\) À É Ë Ì Ò Ù Û &quot; \N \+)*</td> </tr> <tr> <td>enumeration</td> <td>F</td> </tr> <tr> <td>enumeration</td> <td>D</td> </tr> <tr> <td>enumeration</td> <td>A</td> </tr> </tbody> </table> | Kind | Value | pattern | (([0-9A-Z-])"){1}([0-9A-Z&:] ' - \- . \./ ° \^ \(\) À É Ë Ì Ò Ù Û " \N \+)* | enumeration | F | enumeration | D | enumeration | A |
| Kind | Value | | | | | | | | | | |
| pattern | (([0-9A-Z-])"){1}([0-9A-Z&:] ' - \- . \./ ° \^ \(\) À É Ë Ì Ò Ù Û " \N \+)* | | | | | | | | | | |
| enumeration | F | | | | | | | | | | |
| enumeration | D | | | | | | | | | | |
| enumeration | A | | | | | | | | | | |

element **Familiari_PrimoModulo_Type/FigliResEsteri**

| diagram | | | | | |
|-----------|---|------|-------|---------|----------------|
| namespace | urn:www.agenziaentrate.gov.it:specificheTecniche:sco:730 | | | | |
| type | DatoNP Type | | | | |
| facets | <table border="1"> <thead> <tr> <th>Kind</th> <th>Value</th> </tr> </thead> <tbody> <tr> <td>pattern</td> <td>[1-9]{1}[0-9]*</td> </tr> </tbody> </table> | Kind | Value | pattern | [1-9]{1}[0-9]* |
| Kind | Value | | | | |
| pattern | [1-9]{1}[0-9]* | | | | |

element Familiari_PrimoModulo_Type/PercUlteriore

| | |
|-----------|---|
| diagram | |
| namespace | urn:www.agenziaentrate.gov.it:specificheTecniche:sco:730 |
| type | DatoPC_Type |
| facets | Kind Value pattern [0-9]?[0-9](, d{1,3})? 100,0{1,3})? |

complexType Familiari_Type

| | |
|-----------|--|
| diagram | |
| namespace | urn:www.agenziaentrate.gov.it:specificheTecniche:sco:730 |
| children | m730:PrimoModulo m730:Modulo |

element Familiari_Type/PrimoModulo

| | |
|-----------|---|
| diagram | |
| namespace | urn:www.agenziaentrate.gov.it:specificheTecniche:sco:730 |
| type | extension of m730:Modulo_Familiari_Type |
| children | m730:Coniuge m730:PrimoFiglio m730:Familiari m730:PercUlteriore m730:FigliAffidoPread |

element Familiari_Type/PrimoModulo/PercUlteriore

| | |
|-----------|--|
| diagram | |
| namespace | urn:www.agenziaentrate.gov.it:specificheTecniche:sco:730 |
| type | DatoPC_Type |

| | | |
|--------|-----------------|--|
| facets | Kind pattern | Value [0-9]?[0-9](,.\d{1,3})? 100,0{1,3}? |
|--------|-----------------|--|

element Familiari_Type/PrimoModulo/FigliAffidoPread

| | | |
|-----------|--|-------------------------|
| diagram | | |
| namespace | urn:www.agenziaentrate.gov.it:specificheTecniche:sco:730 | |
| type | DatoNP_Type | |
| facets | Kind pattern | Value [1-9]{1}[0-9]* |

element Familiari_Type/Modulo

| | | |
|-----------|--|--|
| diagram | | |
| namespace | urn:www.agenziaentrate.gov.it:specificheTecniche:sco:730 | |
| type | m730:Modulo_Familiari_Type | |
| children | m730:Coniuge m730:PrimoFiglio m730:Familiari | |

complexType Fondo_Pensione_Dipendenti_Pubblici_Type

| | | |
|-----------|---|--|
| diagram | | |
| namespace | urn:www.agenziaentrate.gov.it:specificheTecniche:sco:730 | |
| children | m730:Contributi m730:QuotaTFR | |

element Fondo_Pensione_Dipendenti_Pubblici_Type/Contributi

| | | |
|---------|--|--|
| diagram | | |
|---------|--|--|

| | |
|-----------|--|
| namespace | urn:www.agenziaentrate.gov.it:specificheTecniche:sco:730 |
| type | m730:Contributi Previdenza Complementare Type |
| children | m730:EsclusiDalSostituto m730:NonEsclusiDalSostituto |

element Fondo_Pensione_Dipendenti_Pubblici_Type/QuotaTFR

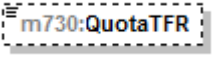
| | |
|-----------|---|
| diagram |  |
| namespace | urn:www.agenziaentrate.gov.it:specificheTecniche:sco:730 |
| type | DatoNP Type |
| facets | Kind Value pattern [1-9]{1}[0-9]* |

complexType Frontespizio_730_Type

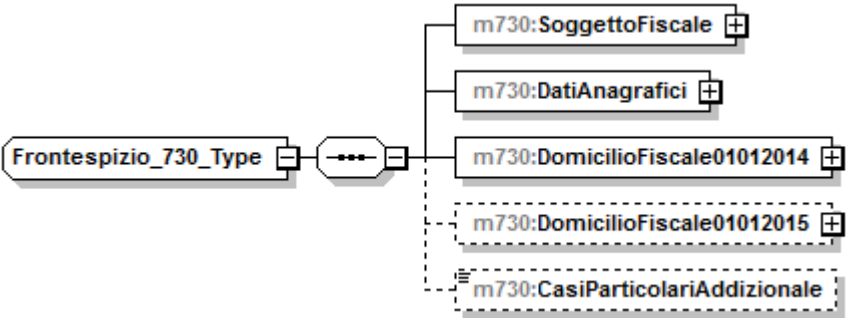
| | |
|-----------|--|
| diagram |  |
| namespace | urn:www.agenziaentrate.gov.it:specificheTecniche:sco:730 |
| children | m730:SoggettoFiscale m730:DatiAnagrafici m730:DomicilioFiscale01012014 m730:DomicilioFiscale01012015 m730:CasiParticolariAddizionale |

element Frontespizio_730_Type/SoggettoFiscale

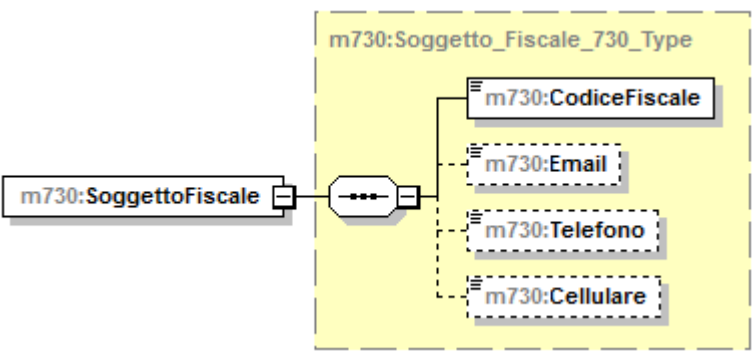
| | |
|-----------|--|
| diagram |  |
| namespace | urn:www.agenziaentrate.gov.it:specificheTecniche:sco:730 |
| type | m730:Soggetto Fiscale 730 Type |
| children | m730:CodiceFiscale m730:Email m730:Telefono m730:Cellulare |

element **Frontespizio_730_Type/DatiAnagrafici**

| | |
|------------------|--|
| <p>diagram</p> | |
| <p>namespace</p> | <p>urn:www.agenziaentrate.gov.it:specificheTecniche:sco:730</p> |
| <p>type</p> | <p>Dati_Anagrafici_Type</p> |
| <p>children</p> | <p>Cognome Nome Sesso DataNascita ComuneNascita ProvinciaNascita</p> |

element **Frontespizio_730_Type/DomicilioFiscale01012014**

| | |
|------------------|---|
| <p>diagram</p> | |
| <p>namespace</p> | <p>urn:www.agenziaentrate.gov.it:specificheTecniche:sco:730</p> |
| <p>type</p> | <p>m730:Domicilio_Fiscale_type</p> |
| <p>children</p> | <p>m730:Comune m730:Provincia m730:CodiceComune</p> |

element Frontespizio_730_Type/DomicilioFiscale01012015

| | |
|-----------|--|
| diagram | |
| namespace | urn:www.agenziaentrate.gov.it:specificheTecniche:sco:730 |
| type | m730:Domicilio Fiscale type |
| children | m730:Comune m730:Provincia m730:CodiceComune |

element Frontespizio_730_Type/CasiParticolariAddizionale

| diagram | | | | | |
|-----------|---|------|-------|---------|------|
| namespace | urn:www.agenziaentrate.gov.it:specificheTecniche:sco:730 | | | | |
| type | DatoCB_Type | | | | |
| facets | <table border="1"> <thead> <tr> <th>Kind</th> <th>Value</th> </tr> </thead> <tbody> <tr> <td>pattern</td> <td>[01]</td> </tr> </tbody> </table> | Kind | Value | pattern | [01] |
| Kind | Value | | | | |
| pattern | [01] | | | | |

complexType Giorni_Percentuale_Type

| | |
|-----------|--|
| diagram | |
| namespace | urn:www.agenziaentrate.gov.it:specificheTecniche:sco:730 |
| children | m730:Giorni m730:Percentuale |

element Giorni_Percentuale_Type/Giorni

| diagram | | | | | |
|-----------|---|------|-------|---------|----------------|
| namespace | urn:www.agenziaentrate.gov.it:specificheTecniche:sco:730 | | | | |
| type | DatoNP_Type | | | | |
| facets | <table border="1"> <thead> <tr> <th>Kind</th> <th>Value</th> </tr> </thead> <tbody> <tr> <td>pattern</td> <td>[1-9]{1}[0-9]*</td> </tr> </tbody> </table> | Kind | Value | pattern | [1-9]{1}[0-9]* |
| Kind | Value | | | | |
| pattern | [1-9]{1}[0-9]* | | | | |

element Giorni_Percentuale_Type/Percentuale

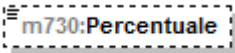
| diagram |  | | | | |
|-----------|---|------|-------|---------|------------------------------------|
| namespace | urn:www.agenziaentrate.gov.it:specificheTecniche:sco:730 | | | | |
| type | DatoPC_Type | | | | |
| facets | <table border="1"> <tr> <th>Kind</th> <th>Value</th> </tr> <tr> <td>pattern</td> <td>[0-9]?[0-9](, d{1,3})? 100,0{1,3}?</td> </tr> </table> | Kind | Value | pattern | [0-9]?[0-9](, d{1,3})? 100,0{1,3}? |
| Kind | Value | | | | |
| pattern | [0-9]?[0-9](, d{1,3})? 100,0{1,3}? | | | | |

complexType Imposta_Lorda_Type

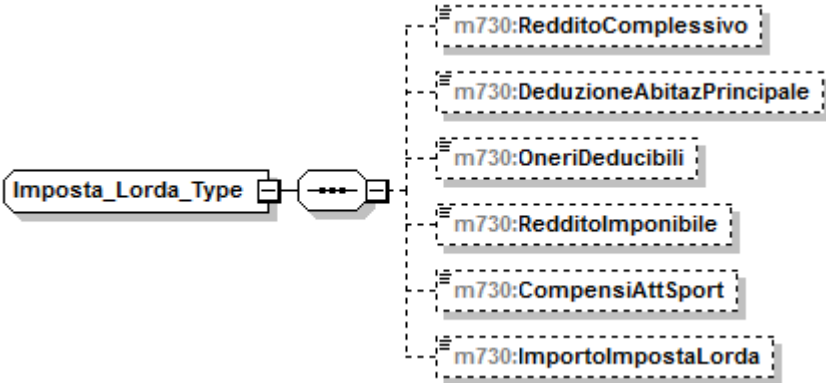
| | |
|-----------|---|
| diagram |  |
| namespace | urn:www.agenziaentrate.gov.it:specificheTecniche:sco:730 |
| children | m730:RedditoComplessivo m730:DeduzioneAbitazPrincipale m730:OneriDeducibili m730:RedditoImponibile m730:CompensiAttSport m730:ImportoImpostaLorda |

element Imposta_Lorda_Type/RedditoComplessivo

| diagram |  | | | | |
|-----------|---|------|-------|---------|----------------|
| namespace | urn:www.agenziaentrate.gov.it:specificheTecniche:sco:730 | | | | |
| type | DatoNP_Type | | | | |
| facets | <table border="1"> <tr> <th>Kind</th> <th>Value</th> </tr> <tr> <td>pattern</td> <td>[1-9]{1}[0-9]*</td> </tr> </table> | Kind | Value | pattern | [1-9]{1}[0-9]* |
| Kind | Value | | | | |
| pattern | [1-9]{1}[0-9]* | | | | |

element Imposta_Lorda_Type/DeduzioneAbitazPrincipale

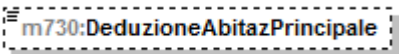
| diagram |  | | | | |
|-----------|---|------|-------|---------|----------------|
| namespace | urn:www.agenziaentrate.gov.it:specificheTecniche:sco:730 | | | | |
| type | DatoNP_Type | | | | |
| facets | <table border="1"> <tr> <th>Kind</th> <th>Value</th> </tr> <tr> <td>pattern</td> <td>[1-9]{1}[0-9]*</td> </tr> </table> | Kind | Value | pattern | [1-9]{1}[0-9]* |
| Kind | Value | | | | |
| pattern | [1-9]{1}[0-9]* | | | | |

element **Imposta_Lorda_Type/OneriDeducibili**

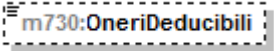
| | |
|-----------|---|
| diagram |  |
| namespace | urn:www.agenziaentrate.gov.it:specificheTecniche:sco:730 |
| type | DatoNP_Type |
| facets | Kind Value pattern [1-9]{1}[0-9]* |

element **Imposta_Lorda_Type/RedditolImponibile**

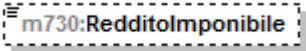
| | |
|-----------|---|
| diagram |  |
| namespace | urn:www.agenziaentrate.gov.it:specificheTecniche:sco:730 |
| type | DatoNP_Type |
| facets | Kind Value pattern [1-9]{1}[0-9]* |

element **Imposta_Lorda_Type/CompensiAttSport**

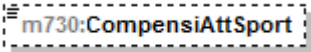
| | |
|-----------|---|
| diagram |  |
| namespace | urn:www.agenziaentrate.gov.it:specificheTecniche:sco:730 |
| type | DatoNP_Type |
| facets | Kind Value pattern [1-9]{1}[0-9]* |

element **Imposta_Lorda_Type/ImportolImpostaLorda**

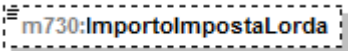
| | |
|-----------|---|
| diagram |  |
| namespace | urn:www.agenziaentrate.gov.it:specificheTecniche:sco:730 |
| type | DatoNP_Type |
| facets | Kind Value pattern [1-9]{1}[0-9]* |

complexType **Imposta_Netta_Type**

| | |
|------------------|--|
| <p>diagram</p> | |
| <p>namespace</p> | <p>urn:www.agenziaentrate.gov.it:specificheTecniche:sco:730</p> |
| <p>children</p> | <p>m730:ImportoImpostaNetta m730:CredAltriSisma m730:CredAbitazSisma m730:CredImpEstere m730:CredErogCultura m730:CredCanNonPerc m730:CredDetrazIncapienti m730:Ritenute m730:Differenza m730:EccedenzaIrf m730:AccontiVersati m730:RestituzioneBonus m730:CredRimborsatiSost m730:BonusIrfSpettante m730:BonusIrfRiconosciuto m730:RestituzioneBonusIrf</p> |

element **Imposta_Netta_Type/ImportoImpostaNetta**

| | | | | | |
|------------------|---|------|-------|---------|----------------|
| <p>diagram</p> | | | | | |
| <p>namespace</p> | <p>urn:www.agenziaentrate.gov.it:specificheTecniche:sco:730</p> | | | | |
| <p>type</p> | <p>DatoNP_Type</p> | | | | |
| <p>facets</p> | <table border="1"> <tr> <td>Kind</td> <td>Value</td> </tr> <tr> <td>pattern</td> <td>[1-9]{1}[0-9]*</td> </tr> </table> | Kind | Value | pattern | [1-9]{1}[0-9]* |
| Kind | Value | | | | |
| pattern | [1-9]{1}[0-9]* | | | | |

element **Imposta_Netta_Type/CredAltriSisma**

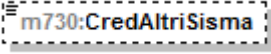
| | | | | | |
|-----------|---|------|-------|---------|----------------|
| diagram |  | | | | |
| namespace | urn:www.agenziaentrate.gov.it:specificheTecniche:sco:730 | | | | |
| type | DatoNP_Type | | | | |
| facets | <table border="1"> <tr> <td>Kind</td> <td>Value</td> </tr> <tr> <td>pattern</td> <td>[1-9]{1}[0-9]*</td> </tr> </table> | Kind | Value | pattern | [1-9]{1}[0-9]* |
| Kind | Value | | | | |
| pattern | [1-9]{1}[0-9]* | | | | |

element **Imposta_Netta_Type/CredAbitazSisma**

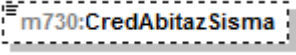
| | | | | | |
|-----------|---|------|-------|---------|----------------|
| diagram |  | | | | |
| namespace | urn:www.agenziaentrate.gov.it:specificheTecniche:sco:730 | | | | |
| type | DatoNP_Type | | | | |
| facets | <table border="1"> <tr> <td>Kind</td> <td>Value</td> </tr> <tr> <td>pattern</td> <td>[1-9]{1}[0-9]*</td> </tr> </table> | Kind | Value | pattern | [1-9]{1}[0-9]* |
| Kind | Value | | | | |
| pattern | [1-9]{1}[0-9]* | | | | |

element **Imposta_Netta_Type/CredImpEstere**

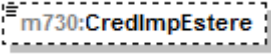
| | | | | | |
|-----------|---|------|-------|---------|----------------|
| diagram |  | | | | |
| namespace | urn:www.agenziaentrate.gov.it:specificheTecniche:sco:730 | | | | |
| type | DatoNP_Type | | | | |
| facets | <table border="1"> <tr> <td>Kind</td> <td>Value</td> </tr> <tr> <td>pattern</td> <td>[1-9]{1}[0-9]*</td> </tr> </table> | Kind | Value | pattern | [1-9]{1}[0-9]* |
| Kind | Value | | | | |
| pattern | [1-9]{1}[0-9]* | | | | |

element **Imposta_Netta_Type/CredErogCultura**

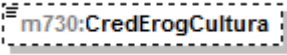
| | | | | | |
|-----------|---|------|-------|---------|----------------|
| diagram |  | | | | |
| namespace | urn:www.agenziaentrate.gov.it:specificheTecniche:sco:730 | | | | |
| type | DatoNP_Type | | | | |
| facets | <table border="1"> <tr> <td>Kind</td> <td>Value</td> </tr> <tr> <td>pattern</td> <td>[1-9]{1}[0-9]*</td> </tr> </table> | Kind | Value | pattern | [1-9]{1}[0-9]* |
| Kind | Value | | | | |
| pattern | [1-9]{1}[0-9]* | | | | |

element **Imposta_Netta_Type/CredCanNonPerc**

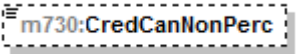
| | | | | | |
|-----------|---|------|-------|---------|----------------|
| diagram |  | | | | |
| namespace | urn:www.agenziaentrate.gov.it:specificheTecniche:sco:730 | | | | |
| type | DatoNP_Type | | | | |
| facets | <table border="1"> <tr> <td>Kind</td> <td>Value</td> </tr> <tr> <td>pattern</td> <td>[1-9]{1}[0-9]*</td> </tr> </table> | Kind | Value | pattern | [1-9]{1}[0-9]* |
| Kind | Value | | | | |
| pattern | [1-9]{1}[0-9]* | | | | |

element **Imposta_Netta_Type/CredDetrazIncapienti**

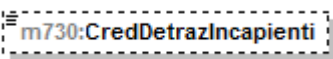
| | |
|-----------|---|
| diagram |  |
| namespace | urn:www.agenziaentrate.gov.it:specificheTecniche:sco:730 |
| type | DatoNP_Type |
| facets | Kind Value pattern [1-9]{1}[0-9]* |

element **Imposta_Netta_Type/Ritenute**

| | |
|-----------|---|
| diagram |  |
| namespace | urn:www.agenziaentrate.gov.it:specificheTecniche:sco:730 |
| type | DatoNP_Type |
| facets | Kind Value pattern [1-9]{1}[0-9]* |

element **Imposta_Netta_Type/Differenza**

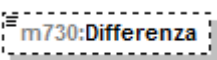
| | |
|-----------|---|
| diagram |  |
| namespace | urn:www.agenziaentrate.gov.it:specificheTecniche:sco:730 |
| type | DatoNU_Type |
| facets | Kind Value pattern (\-[1-9] [1-9])[0-9]* |

element **Imposta_Netta_Type/Eccedenzalrpef**

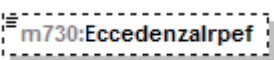
| | |
|-----------|---|
| diagram |  |
| namespace | urn:www.agenziaentrate.gov.it:specificheTecniche:sco:730 |
| type | DatoNU_Type |
| facets | Kind Value pattern (\-[1-9] [1-9])[0-9]* |

element **Imposta_Netta_Type/AccontiVersati**

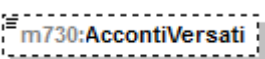
| | |
|-----------|---|
| diagram |  |
| namespace | urn:www.agenziaentrate.gov.it:specificheTecniche:sco:730 |
| type | DatoNP_Type |
| facets | Kind Value pattern [1-9]{1}[0-9]* |

element **Imposta_Netta_Type/RestituzioneBonus**

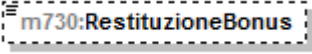
| | |
|-----------|---|
| diagram |  |
| namespace | urn:www.agenziaentrate.gov.it:specificheTecniche:sco:730 |
| type | DatoNP_Type |
| facets | Kind Value pattern [1-9]{1}[0-9]* |

element **Imposta_Netta_Type/CredRimborsatiSost**

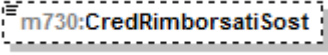
| | |
|-----------|---|
| diagram |  |
| namespace | urn:www.agenziaentrate.gov.it:specificheTecniche:sco:730 |
| type | DatoNP_Type |
| facets | Kind Value pattern [1-9]{1}[0-9]* |

element **Imposta_Netta_Type/BonuslrpefSpettante**

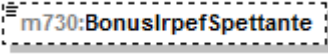
| | |
|-----------|---|
| diagram |  |
| namespace | urn:www.agenziaentrate.gov.it:specificheTecniche:sco:730 |
| type | DatoNP_Type |
| facets | Kind Value pattern [1-9]{1}[0-9]* |

element **Imposta_Netta_Type/BonuslrpefRiconosciuto**

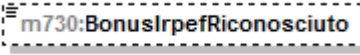
| | |
|-----------|---|
| diagram |  |
| namespace | urn:www.agenziaentrate.gov.it:specificheTecniche:sco:730 |
| type | DatoNP_Type |
| facets | Kind Value pattern [1-9]{1}[0-9]* |

element **Imposta_Netta_Type/RestituzioneBonuslrpef**

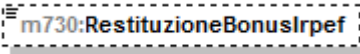
| | |
|-----------|---|
| diagram |  |
| namespace | urn:www.agenziaentrate.gov.it:specificheTecniche:sco:730 |
| type | DatoNP_Type |
| facets | Kind Value pattern [1-9]{1}[0-9]* |

complexType **Imposte_Rimborsate_Type**

| | |
|-----------|--|
| diagram | |
| namespace | urn:www.agenziaentrate.gov.it:specificheTecniche:sco:730 |
| children | m730:TipoReddito m730:TassazioneSeparata |

element **Imposte_Rimborsate_Type/TipoReddito**

| | | | | | | | | | | | | | | | | | | | | | |
|-------------|---|------|-------|---------|----------------|-------------|---|-------------|---|-------------|---|-------------|---|-------------|---|-------------|---|-------------|---|-------------|---|
| diagram | | | | | | | | | | | | | | | | | | | | | |
| namespace | urn:www.agenziaentrate.gov.it:specificheTecniche:sco:730 | | | | | | | | | | | | | | | | | | | | |
| type | m730:Tipo_Reddito_Da1a8_Type | | | | | | | | | | | | | | | | | | | | |
| facets | <table border="0"> <tr> <td>Kind</td> <td>Value</td> </tr> <tr> <td>pattern</td> <td>[1-9]{1}[0-9]*</td> </tr> <tr> <td>enumeration</td> <td>1</td> </tr> <tr> <td>enumeration</td> <td>2</td> </tr> <tr> <td>enumeration</td> <td>3</td> </tr> <tr> <td>enumeration</td> <td>4</td> </tr> <tr> <td>enumeration</td> <td>5</td> </tr> <tr> <td>enumeration</td> <td>6</td> </tr> <tr> <td>enumeration</td> <td>7</td> </tr> <tr> <td>enumeration</td> <td>8</td> </tr> </table> | Kind | Value | pattern | [1-9]{1}[0-9]* | enumeration | 1 | enumeration | 2 | enumeration | 3 | enumeration | 4 | enumeration | 5 | enumeration | 6 | enumeration | 7 | enumeration | 8 |
| Kind | Value | | | | | | | | | | | | | | | | | | | | |
| pattern | [1-9]{1}[0-9]* | | | | | | | | | | | | | | | | | | | | |
| enumeration | 1 | | | | | | | | | | | | | | | | | | | | |
| enumeration | 2 | | | | | | | | | | | | | | | | | | | | |
| enumeration | 3 | | | | | | | | | | | | | | | | | | | | |
| enumeration | 4 | | | | | | | | | | | | | | | | | | | | |
| enumeration | 5 | | | | | | | | | | | | | | | | | | | | |
| enumeration | 6 | | | | | | | | | | | | | | | | | | | | |
| enumeration | 7 | | | | | | | | | | | | | | | | | | | | |
| enumeration | 8 | | | | | | | | | | | | | | | | | | | | |

element **Imposte_Rimborsate_Type/TassazioneSeparata**

| | |
|-----------|---|
| diagram | |
| namespace | urn:www.agenziaentrate.gov.it:specificheTecniche:sco:730 |
| type | m730:Tassazione_Separata_Type |
| children | m730:Opzione m730:Anno m730:RedditoRitenute |

complexType Incremento_Produttivita_Type

| | |
|-----------|--|
| diagram | |
| namespace | urn:www.agenziaentrate.gov.it:specificheTecniche:sco:730 |
| children | m730:ImportoTassazOrdinaria m730:ImportoImpostaSostitutiva m730:RitenuteImpostaSostitutiva m730:Art51Ordinaria m730:Art51Sostitutiva m730:TassazOrdinaria m730:TassazSostitutiva |

element Incremento_Produttivita_Type/ImportoTassazOrdinaria

| | | | | | |
|-----------|---|------|-------|---------|----------------|
| diagram | | | | | |
| namespace | urn:www.agenziaentrate.gov.it:specificheTecniche:sco:730 | | | | |
| type | DatoNP_Type | | | | |
| facets | <table border="1"> <tr> <td>Kind</td> <td>Value</td> </tr> <tr> <td>pattern</td> <td>[1-9]{1}[0-9]*</td> </tr> </table> | Kind | Value | pattern | [1-9]{1}[0-9]* |
| Kind | Value | | | | |
| pattern | [1-9]{1}[0-9]* | | | | |

element Incremento_Produttivita_Type/ImportoImpostaSostitutiva

| | | | | | |
|-----------|---|------|-------|---------|----------------|
| diagram | | | | | |
| namespace | urn:www.agenziaentrate.gov.it:specificheTecniche:sco:730 | | | | |
| type | DatoNP_Type | | | | |
| facets | <table border="1"> <tr> <td>Kind</td> <td>Value</td> </tr> <tr> <td>pattern</td> <td>[1-9]{1}[0-9]*</td> </tr> </table> | Kind | Value | pattern | [1-9]{1}[0-9]* |
| Kind | Value | | | | |
| pattern | [1-9]{1}[0-9]* | | | | |

element Incremento_Produttivita_Type/RitenuteImpostaSostitutiva

| | | | | | |
|-----------|---|------|-------|---------|----------------|
| diagram | | | | | |
| namespace | urn:www.agenziaentrate.gov.it:specificheTecniche:sco:730 | | | | |
| type | DatoNP_Type | | | | |
| facets | <table border="1"> <tr> <td>Kind</td> <td>Value</td> </tr> <tr> <td>pattern</td> <td>[1-9]{1}[0-9]*</td> </tr> </table> | Kind | Value | pattern | [1-9]{1}[0-9]* |
| Kind | Value | | | | |
| pattern | [1-9]{1}[0-9]* | | | | |

element Incremento_Produttivita_Type/Art51Ordinaria

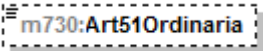
| | | | | | |
|-----------|---|------|-------|---------|----------------|
| diagram |  | | | | |
| namespace | urn:www.agenziaentrate.gov.it:specificheTecniche:sco:730 | | | | |
| type | DatoNP_Type | | | | |
| facets | <table border="1"> <tr> <td>Kind</td> <td>Value</td> </tr> <tr> <td>pattern</td> <td>[1-9]{1}[0-9]*</td> </tr> </table> | Kind | Value | pattern | [1-9]{1}[0-9]* |
| Kind | Value | | | | |
| pattern | [1-9]{1}[0-9]* | | | | |

element Incremento_Produttivita_Type/Art51Sostitutiva

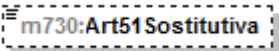
| | | | | | |
|-----------|---|------|-------|---------|----------------|
| diagram |  | | | | |
| namespace | urn:www.agenziaentrate.gov.it:specificheTecniche:sco:730 | | | | |
| type | DatoNP_Type | | | | |
| facets | <table border="1"> <tr> <td>Kind</td> <td>Value</td> </tr> <tr> <td>pattern</td> <td>[1-9]{1}[0-9]*</td> </tr> </table> | Kind | Value | pattern | [1-9]{1}[0-9]* |
| Kind | Value | | | | |
| pattern | [1-9]{1}[0-9]* | | | | |

element Incremento_Produttivita_Type/TassazOrdinaria

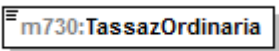
| | | | | | |
|-----------|---|------|-------|---------|------|
| diagram |  | | | | |
| namespace | urn:www.agenziaentrate.gov.it:specificheTecniche:sco:730 | | | | |
| type | DatoCB_Type | | | | |
| facets | <table border="1"> <tr> <td>Kind</td> <td>Value</td> </tr> <tr> <td>pattern</td> <td>[01]</td> </tr> </table> | Kind | Value | pattern | [01] |
| Kind | Value | | | | |
| pattern | [01] | | | | |

element Incremento_Produttivita_Type/TassazSostitutiva

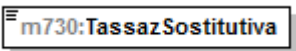
| | | | | | |
|-----------|---|------|-------|---------|------|
| diagram |  | | | | |
| namespace | urn:www.agenziaentrate.gov.it:specificheTecniche:sco:730 | | | | |
| type | DatoCB_Type | | | | |
| facets | <table border="1"> <tr> <td>Kind</td> <td>Value</td> </tr> <tr> <td>pattern</td> <td>[01]</td> </tr> </table> | Kind | Value | pattern | [01] |
| Kind | Value | | | | |
| pattern | [01] | | | | |

complexType Inquilini_Abitazione_Principale_Type

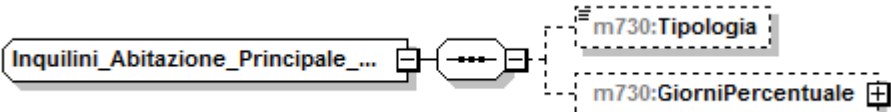
| | |
|-----------|--|
| diagram |  |
| namespace | urn:www.agenziaentrate.gov.it:specificheTecniche:sco:730 |
| children | m730:Tipologia m730:GiorniPercentuale |

element **Inquilini_Abitazione_Principale_Type/Tipologia**

| | | | | | | | | | | | | | |
|-------------|---|------|-------|---------|----------------|-------------|---|-------------|---|-------------|---|-------------|---|
| diagram |  | | | | | | | | | | | | |
| namespace | urn:www.agenziaentrate.gov.it:specificheTecniche:sco:730 | | | | | | | | | | | | |
| type | m730:Tipo Inquilino Type | | | | | | | | | | | | |
| facets | <table border="0"> <tr> <td>Kind</td> <td>Value</td> </tr> <tr> <td>pattern</td> <td>[1-9]{1}[0-9]*</td> </tr> <tr> <td>enumeration</td> <td>1</td> </tr> <tr> <td>enumeration</td> <td>2</td> </tr> <tr> <td>enumeration</td> <td>3</td> </tr> <tr> <td>enumeration</td> <td>4</td> </tr> </table> | Kind | Value | pattern | [1-9]{1}[0-9]* | enumeration | 1 | enumeration | 2 | enumeration | 3 | enumeration | 4 |
| Kind | Value | | | | | | | | | | | | |
| pattern | [1-9]{1}[0-9]* | | | | | | | | | | | | |
| enumeration | 1 | | | | | | | | | | | | |
| enumeration | 2 | | | | | | | | | | | | |
| enumeration | 3 | | | | | | | | | | | | |
| enumeration | 4 | | | | | | | | | | | | |

element **Inquilini_Abitazione_Principale_Type/GiorniPercentuale**

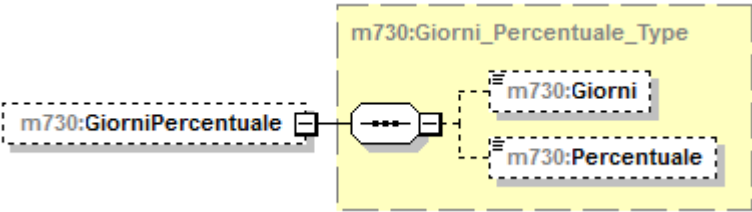
| | |
|-----------|--|
| diagram |  |
| namespace | urn:www.agenziaentrate.gov.it:specificheTecniche:sco:730 |
| type | m730:Giorni Percentuale Type |
| children | m730:Giorni m730:Percentuale |

complexType **Intervento_Ricupero_Patrimonio_Edificio_Type**

| | |
|-----------|--|
| diagram | |
| namespace | urn:www.agenziaentrate.gov.it:specificheTecniche:sco:730 |
| children | m730:Anno m730:Periodo m730:CodiceFiscale m730:CasellaInterventiParticolari m730:CodiceSituazioniParticolari m730:AnnoSituazioniParticolari m730:RideterminazioneRate m730:NRate m730:Spesa m730:NOrdineImmobile |

element **Intervento_Ricupero_Patrimonio_Edificio_Type/Anno**

| | | | | | | | | | | | | | | | | | | | | | | | | | |
|-------------|---|------|-------|---------|----------------|-------------|------|-------------|------|-------------|------|-------------|------|-------------|------|-------------|------|-------------|------|-------------|------|-------------|------|-------------|------|
| diagram | | | | | | | | | | | | | | | | | | | | | | | | | |
| namespace | urn:www.agenziaentrate.gov.it:specificheTecniche:sco:730 | | | | | | | | | | | | | | | | | | | | | | | | |
| type | restriction of m730:Anno_Ricupero_Patrimonio_Edificio_Type | | | | | | | | | | | | | | | | | | | | | | | | |
| facets | <table border="0"> <tr> <td>Kind</td> <td>Value</td> </tr> <tr> <td>pattern</td> <td>[1-9]{1}[0-9]*</td> </tr> <tr> <td>enumeration</td> <td>2005</td> </tr> <tr> <td>enumeration</td> <td>2006</td> </tr> <tr> <td>enumeration</td> <td>2007</td> </tr> <tr> <td>enumeration</td> <td>2008</td> </tr> <tr> <td>enumeration</td> <td>2009</td> </tr> <tr> <td>enumeration</td> <td>2010</td> </tr> <tr> <td>enumeration</td> <td>2011</td> </tr> <tr> <td>enumeration</td> <td>2012</td> </tr> <tr> <td>enumeration</td> <td>2013</td> </tr> <tr> <td>enumeration</td> <td>2014</td> </tr> </table> | Kind | Value | pattern | [1-9]{1}[0-9]* | enumeration | 2005 | enumeration | 2006 | enumeration | 2007 | enumeration | 2008 | enumeration | 2009 | enumeration | 2010 | enumeration | 2011 | enumeration | 2012 | enumeration | 2013 | enumeration | 2014 |
| Kind | Value | | | | | | | | | | | | | | | | | | | | | | | | |
| pattern | [1-9]{1}[0-9]* | | | | | | | | | | | | | | | | | | | | | | | | |
| enumeration | 2005 | | | | | | | | | | | | | | | | | | | | | | | | |
| enumeration | 2006 | | | | | | | | | | | | | | | | | | | | | | | | |
| enumeration | 2007 | | | | | | | | | | | | | | | | | | | | | | | | |
| enumeration | 2008 | | | | | | | | | | | | | | | | | | | | | | | | |
| enumeration | 2009 | | | | | | | | | | | | | | | | | | | | | | | | |
| enumeration | 2010 | | | | | | | | | | | | | | | | | | | | | | | | |
| enumeration | 2011 | | | | | | | | | | | | | | | | | | | | | | | | |
| enumeration | 2012 | | | | | | | | | | | | | | | | | | | | | | | | |
| enumeration | 2013 | | | | | | | | | | | | | | | | | | | | | | | | |
| enumeration | 2014 | | | | | | | | | | | | | | | | | | | | | | | | |

element **Intervento_Ricupero_Patrimonio_Edificio_Type/Periodo**

| | |
|-----------|--|
| diagram | |
| namespace | urn:www.agenziaentrate.gov.it:specificheTecniche:sco:730 |
| type | m730:Periodo_Spese_Ristrutturazione_Type |

| | | |
|--------|-------------|-------|
| facets | Kind | Value |
| | pattern | [1-9] |
| | enumeration | 1 |
| | enumeration | 2 |
| | enumeration | 3 |
| | enumeration | 4 |

element Intervento_Ricupero_Patrimonio_Edilizio_Type/CodiceFiscale

| | | | | | |
|-----------|---|------|-------|---------|--|
| diagram | | | | | |
| namespace | urn:www.agenziaentrate.gov.it:specificheTecniche:sco:730 | | | | |
| type | DatoCF_Type | | | | |
| facets | <table border="1"> <tr> <td>Kind</td> <td>Value</td> </tr> <tr> <td>pattern</td> <td>[0-9]{11}[A-Z]{6}[0-9LMNPQRSTU]{2}[A-Z]{1}[0-9LMNPQRSTU]{2}[A-Z]{1}[0-9LMNPQRSTU]{3}[A-Z]{1}</td> </tr> </table> | Kind | Value | pattern | [0-9]{11}[A-Z]{6}[0-9LMNPQRSTU]{2}[A-Z]{1}[0-9LMNPQRSTU]{2}[A-Z]{1}[0-9LMNPQRSTU]{3}[A-Z]{1} |
| Kind | Value | | | | |
| pattern | [0-9]{11}[A-Z]{6}[0-9LMNPQRSTU]{2}[A-Z]{1}[0-9LMNPQRSTU]{2}[A-Z]{1}[0-9LMNPQRSTU]{3}[A-Z]{1} | | | | |

element Intervento_Ricupero_Patrimonio_Edilizio_Type/CasellaInterventiParticolari

| | | | | | | | | | | | |
|-------------|---|------|-------|---------|-------|-------------|---|-------------|---|-------------|---|
| diagram | | | | | | | | | | | |
| namespace | urn:www.agenziaentrate.gov.it:specificheTecniche:sco:730 | | | | | | | | | | |
| type | restriction of DatoN1_Type | | | | | | | | | | |
| facets | <table border="1"> <tr> <td>Kind</td> <td>Value</td> </tr> <tr> <td>pattern</td> <td>[1-9]</td> </tr> <tr> <td>enumeration</td> <td>1</td> </tr> <tr> <td>enumeration</td> <td>3</td> </tr> <tr> <td>enumeration</td> <td>4</td> </tr> </table> | Kind | Value | pattern | [1-9] | enumeration | 1 | enumeration | 3 | enumeration | 4 |
| Kind | Value | | | | | | | | | | |
| pattern | [1-9] | | | | | | | | | | |
| enumeration | 1 | | | | | | | | | | |
| enumeration | 3 | | | | | | | | | | |
| enumeration | 4 | | | | | | | | | | |

element Intervento_Ricupero_Patrimonio_Edilizio_Type/CodiceSituazioniParticolari

| | | | | | | | | | |
|-------------|--|------|-------|---------|-------|-------------|---|-------------|---|
| diagram | | | | | | | | | |
| namespace | urn:www.agenziaentrate.gov.it:specificheTecniche:sco:730 | | | | | | | | |
| type | m730:Casella_Codice_Type | | | | | | | | |
| facets | <table border="1"> <tr> <td>Kind</td> <td>Value</td> </tr> <tr> <td>pattern</td> <td>[1-9]</td> </tr> <tr> <td>enumeration</td> <td>1</td> </tr> <tr> <td>enumeration</td> <td>4</td> </tr> </table> | Kind | Value | pattern | [1-9] | enumeration | 1 | enumeration | 4 |
| Kind | Value | | | | | | | | |
| pattern | [1-9] | | | | | | | | |
| enumeration | 1 | | | | | | | | |
| enumeration | 4 | | | | | | | | |

element Intervento_Ricupero_Patrimonio_Edilizio_Type/AnnoSituazioniParticolari

| | | | | | | | | | |
|-------------|---|------|-------|---------|----------------|-------------|------|-------------|------|
| diagram | | | | | | | | | |
| namespace | urn:www.agenziaentrate.gov.it:specificheTecniche:sco:730 | | | | | | | | |
| type | m730:Anno_Patrimonio_Edilizio_Situazioni_Particolari_Type | | | | | | | | |
| facets | <table border="1"> <tr> <td>Kind</td> <td>Value</td> </tr> <tr> <td>pattern</td> <td>[1-9]{1}[0-9]*</td> </tr> <tr> <td>enumeration</td> <td>2010</td> </tr> <tr> <td>enumeration</td> <td>2011</td> </tr> </table> | Kind | Value | pattern | [1-9]{1}[0-9]* | enumeration | 2010 | enumeration | 2011 |
| Kind | Value | | | | | | | | |
| pattern | [1-9]{1}[0-9]* | | | | | | | | |
| enumeration | 2010 | | | | | | | | |
| enumeration | 2011 | | | | | | | | |

element Intervento_Ricupero_Patrimonio_Edilizio_Type/RideterminazioneRate

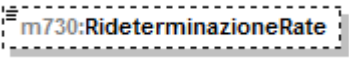
| | | | | | | | |
|-------------|---|------|-------|---------|----------------|-------------|----|
| diagram |  | | | | | | |
| namespace | urn:www.agenziaentrate.gov.it:specificheTecniche:sco:730 | | | | | | |
| type | m730:Rideterminazione Rate Type | | | | | | |
| facets | <table border="0"> <tr> <td>Kind</td> <td>Value</td> </tr> <tr> <td>pattern</td> <td>[1-9]{1}[0-9]*</td> </tr> <tr> <td>enumeration</td> <td>10</td> </tr> </table> | Kind | Value | pattern | [1-9]{1}[0-9]* | enumeration | 10 |
| Kind | Value | | | | | | |
| pattern | [1-9]{1}[0-9]* | | | | | | |
| enumeration | 10 | | | | | | |

element Intervento_Ricupero_Patrimonio_Edilizio_Type/NRate

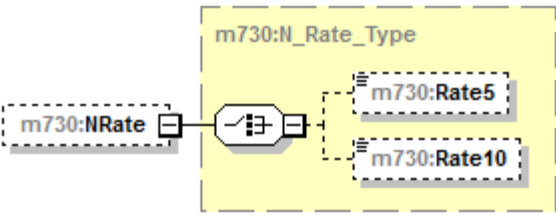
| | |
|-----------|---|
| diagram |  |
| namespace | urn:www.agenziaentrate.gov.it:specificheTecniche:sco:730 |
| type | m730:N Rate Type |
| children | m730:Rate5 m730:Rate10 |

element Intervento_Ricupero_Patrimonio_Edilizio_Type/Spesa

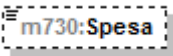
| | | | | | |
|-----------|---|------|-------|---------|----------------|
| diagram |  | | | | |
| namespace | urn:www.agenziaentrate.gov.it:specificheTecniche:sco:730 | | | | |
| type | DatoNP Type | | | | |
| facets | <table border="0"> <tr> <td>Kind</td> <td>Value</td> </tr> <tr> <td>pattern</td> <td>[1-9]{1}[0-9]*</td> </tr> </table> | Kind | Value | pattern | [1-9]{1}[0-9]* |
| Kind | Value | | | | |
| pattern | [1-9]{1}[0-9]* | | | | |

element Intervento_Ricupero_Patrimonio_Edilizio_Type/NOrdinImmobile

| | | | | | |
|-----------|---|------|-------|---------|----------------|
| diagram |  | | | | |
| namespace | urn:www.agenziaentrate.gov.it:specificheTecniche:sco:730 | | | | |
| type | DatoNP Type | | | | |
| facets | <table border="0"> <tr> <td>Kind</td> <td>Value</td> </tr> <tr> <td>pattern</td> <td>[1-9]{1}[0-9]*</td> </tr> </table> | Kind | Value | pattern | [1-9]{1}[0-9]* |
| Kind | Value | | | | |
| pattern | [1-9]{1}[0-9]* | | | | |

complexType Intervento_Risparmio_Energetico_Type

| | |
|-----------|--|
| diagram | |
| namespace | urn:www.agenziaentrate.gov.it:specificheTecniche:sco:730 |
| children | m730:TipoIntervento m730:Anno m730:Periodo2013 m730:CasiParticolari m730:RideterminazioneRate m730:RipartizioneRate m730:NumeroRata m730:Spesa |

element Intervento_Risparmio_Energetico_Type/TipoIntervento

| | | | | | | | | | | | | | |
|-------------|--|------|-------|---------|-------|-------------|---|-------------|---|-------------|---|-------------|---|
| diagram | | | | | | | | | | | | | |
| namespace | urn:www.agenziaentrate.gov.it:specificheTecniche:sco:730 | | | | | | | | | | | | |
| type | m730:Tipo_Intervento_Type | | | | | | | | | | | | |
| facets | <table border="0"> <tr> <td>Kind</td> <td>Value</td> </tr> <tr> <td>pattern</td> <td>[1-9]</td> </tr> <tr> <td>enumeration</td> <td>1</td> </tr> <tr> <td>enumeration</td> <td>2</td> </tr> <tr> <td>enumeration</td> <td>3</td> </tr> <tr> <td>enumeration</td> <td>4</td> </tr> </table> | Kind | Value | pattern | [1-9] | enumeration | 1 | enumeration | 2 | enumeration | 3 | enumeration | 4 |
| Kind | Value | | | | | | | | | | | | |
| pattern | [1-9] | | | | | | | | | | | | |
| enumeration | 1 | | | | | | | | | | | | |
| enumeration | 2 | | | | | | | | | | | | |
| enumeration | 3 | | | | | | | | | | | | |
| enumeration | 4 | | | | | | | | | | | | |

element Intervento_Risparmio_Energetico_Type/Anno

| | | | | | | | | | | | | | | | | | |
|-------------|---|------|-------|---------|----------------|-------------|------|-------------|------|-------------|------|-------------|------|-------------|------|-------------|------|
| diagram | | | | | | | | | | | | | | | | | |
| namespace | urn:www.agenziaentrate.gov.it:specificheTecniche:sco:730 | | | | | | | | | | | | | | | | |
| type | restriction of m730:Anno_Risparmio_Energetico_Type | | | | | | | | | | | | | | | | |
| facets | <table border="0"> <tr> <td>Kind</td> <td>Value</td> </tr> <tr> <td>pattern</td> <td>[1-9]{1}[0-9]*</td> </tr> <tr> <td>enumeration</td> <td>2008</td> </tr> <tr> <td>enumeration</td> <td>2010</td> </tr> <tr> <td>enumeration</td> <td>2011</td> </tr> <tr> <td>enumeration</td> <td>2012</td> </tr> <tr> <td>enumeration</td> <td>2013</td> </tr> <tr> <td>enumeration</td> <td>2014</td> </tr> </table> | Kind | Value | pattern | [1-9]{1}[0-9]* | enumeration | 2008 | enumeration | 2010 | enumeration | 2011 | enumeration | 2012 | enumeration | 2013 | enumeration | 2014 |
| Kind | Value | | | | | | | | | | | | | | | | |
| pattern | [1-9]{1}[0-9]* | | | | | | | | | | | | | | | | |
| enumeration | 2008 | | | | | | | | | | | | | | | | |
| enumeration | 2010 | | | | | | | | | | | | | | | | |
| enumeration | 2011 | | | | | | | | | | | | | | | | |
| enumeration | 2012 | | | | | | | | | | | | | | | | |
| enumeration | 2013 | | | | | | | | | | | | | | | | |
| enumeration | 2014 | | | | | | | | | | | | | | | | |

element **Intervento_Risparmio_Energetico_Type/Periodo2013**

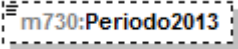
| diagram |  | | | | | | | | |
|-------------|---|------|-------|---------|-------|-------------|---|-------------|---|
| namespace | urn:www.agenziaentrate.gov.it:specificheTecniche:sco:730 | | | | | | | | |
| type | restriction of DatoN1_Type | | | | | | | | |
| facets | <table> <thead> <tr> <th>Kind</th> <th>Value</th> </tr> </thead> <tbody> <tr> <td>pattern</td> <td>[1-9]</td> </tr> <tr> <td>enumeration</td> <td>1</td> </tr> <tr> <td>enumeration</td> <td>2</td> </tr> </tbody> </table> | Kind | Value | pattern | [1-9] | enumeration | 1 | enumeration | 2 |
| Kind | Value | | | | | | | | |
| pattern | [1-9] | | | | | | | | |
| enumeration | 1 | | | | | | | | |
| enumeration | 2 | | | | | | | | |

element **Intervento_Risparmio_Energetico_Type/CasiParticolari**

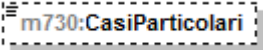
| diagram |  | | | | | | | | | | |
|-------------|--|------|-------|---------|-------|-------------|---|-------------|---|-------------|---|
| namespace | urn:www.agenziaentrate.gov.it:specificheTecniche:sco:730 | | | | | | | | | | |
| type | m730:Casi_Particolari_Risp_Ener_Type | | | | | | | | | | |
| facets | <table> <thead> <tr> <th>Kind</th> <th>Value</th> </tr> </thead> <tbody> <tr> <td>pattern</td> <td>[1-9]</td> </tr> <tr> <td>enumeration</td> <td>1</td> </tr> <tr> <td>enumeration</td> <td>2</td> </tr> <tr> <td>enumeration</td> <td>3</td> </tr> </tbody> </table> | Kind | Value | pattern | [1-9] | enumeration | 1 | enumeration | 2 | enumeration | 3 |
| Kind | Value | | | | | | | | | | |
| pattern | [1-9] | | | | | | | | | | |
| enumeration | 1 | | | | | | | | | | |
| enumeration | 2 | | | | | | | | | | |
| enumeration | 3 | | | | | | | | | | |

element **Intervento_Risparmio_Energetico_Type/RideterminazioneRate**

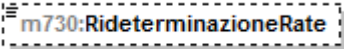
| diagram |  | | | | | | | | | | | | | | | | | | | | |
|-------------|---|------|-------|---------|----------------|-------------|---|-------------|---|-------------|---|-------------|---|-------------|---|-------------|---|-------------|---|-------------|----|
| namespace | urn:www.agenziaentrate.gov.it:specificheTecniche:sco:730 | | | | | | | | | | | | | | | | | | | | |
| type | m730:Rate_Risparmio_Energetico_Type | | | | | | | | | | | | | | | | | | | | |
| facets | <table> <thead> <tr> <th>Kind</th> <th>Value</th> </tr> </thead> <tbody> <tr> <td>pattern</td> <td>[1-9]{1}[0-9]*</td> </tr> <tr> <td>enumeration</td> <td>3</td> </tr> <tr> <td>enumeration</td> <td>4</td> </tr> <tr> <td>enumeration</td> <td>5</td> </tr> <tr> <td>enumeration</td> <td>6</td> </tr> <tr> <td>enumeration</td> <td>7</td> </tr> <tr> <td>enumeration</td> <td>8</td> </tr> <tr> <td>enumeration</td> <td>9</td> </tr> <tr> <td>enumeration</td> <td>10</td> </tr> </tbody> </table> | Kind | Value | pattern | [1-9]{1}[0-9]* | enumeration | 3 | enumeration | 4 | enumeration | 5 | enumeration | 6 | enumeration | 7 | enumeration | 8 | enumeration | 9 | enumeration | 10 |
| Kind | Value | | | | | | | | | | | | | | | | | | | | |
| pattern | [1-9]{1}[0-9]* | | | | | | | | | | | | | | | | | | | | |
| enumeration | 3 | | | | | | | | | | | | | | | | | | | | |
| enumeration | 4 | | | | | | | | | | | | | | | | | | | | |
| enumeration | 5 | | | | | | | | | | | | | | | | | | | | |
| enumeration | 6 | | | | | | | | | | | | | | | | | | | | |
| enumeration | 7 | | | | | | | | | | | | | | | | | | | | |
| enumeration | 8 | | | | | | | | | | | | | | | | | | | | |
| enumeration | 9 | | | | | | | | | | | | | | | | | | | | |
| enumeration | 10 | | | | | | | | | | | | | | | | | | | | |

element **Intervento_Risparmio_Energetico_Type/RipartizioneRate**

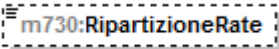
| diagram |  | | | | | | | | | | | | |
|-------------|--|------|-------|---------|----------------|-------------|---|-------------|---|-------------|---|-------------|---|
| namespace | urn:www.agenziaentrate.gov.it:specificheTecniche:sco:730 | | | | | | | | | | | | |
| type | m730:Ripart_Risparmio_Energetico_Type | | | | | | | | | | | | |
| facets | <table> <thead> <tr> <th>Kind</th> <th>Value</th> </tr> </thead> <tbody> <tr> <td>pattern</td> <td>[1-9]{1}[0-9]*</td> </tr> <tr> <td>enumeration</td> <td>4</td> </tr> <tr> <td>enumeration</td> <td>5</td> </tr> <tr> <td>enumeration</td> <td>6</td> </tr> <tr> <td>enumeration</td> <td>7</td> </tr> </tbody> </table> | Kind | Value | pattern | [1-9]{1}[0-9]* | enumeration | 4 | enumeration | 5 | enumeration | 6 | enumeration | 7 |
| Kind | Value | | | | | | | | | | | | |
| pattern | [1-9]{1}[0-9]* | | | | | | | | | | | | |
| enumeration | 4 | | | | | | | | | | | | |
| enumeration | 5 | | | | | | | | | | | | |
| enumeration | 6 | | | | | | | | | | | | |
| enumeration | 7 | | | | | | | | | | | | |

| | |
|--|----------------|
| | enumeration 8 |
| | enumeration 9 |
| | enumeration 10 |

element Intervento_Risparmio_Energetico_Type/NumeroRata

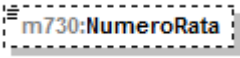
| diagram |  | | | | | | | | | | | | | | | | | | |
|-------------|--|------|-------|---------|----------------|-------------|---|-------------|---|-------------|---|-------------|---|-------------|---|-------------|---|-------------|---|
| namespace | urn:www.agenziaentrate.gov.it:specificheTecniche:sco:730 | | | | | | | | | | | | | | | | | | |
| type | m730:Numero_Rata_Risparmi_Energetico_Type | | | | | | | | | | | | | | | | | | |
| facets | <table border="1"> <thead> <tr> <th>Kind</th> <th>Value</th> </tr> </thead> <tbody> <tr> <td>pattern</td> <td>[1-9]{1}[0-9]*</td> </tr> <tr> <td>enumeration</td> <td>1</td> </tr> <tr> <td>enumeration</td> <td>2</td> </tr> <tr> <td>enumeration</td> <td>3</td> </tr> <tr> <td>enumeration</td> <td>4</td> </tr> <tr> <td>enumeration</td> <td>5</td> </tr> <tr> <td>enumeration</td> <td>6</td> </tr> <tr> <td>enumeration</td> <td>7</td> </tr> </tbody> </table> | Kind | Value | pattern | [1-9]{1}[0-9]* | enumeration | 1 | enumeration | 2 | enumeration | 3 | enumeration | 4 | enumeration | 5 | enumeration | 6 | enumeration | 7 |
| Kind | Value | | | | | | | | | | | | | | | | | | |
| pattern | [1-9]{1}[0-9]* | | | | | | | | | | | | | | | | | | |
| enumeration | 1 | | | | | | | | | | | | | | | | | | |
| enumeration | 2 | | | | | | | | | | | | | | | | | | |
| enumeration | 3 | | | | | | | | | | | | | | | | | | |
| enumeration | 4 | | | | | | | | | | | | | | | | | | |
| enumeration | 5 | | | | | | | | | | | | | | | | | | |
| enumeration | 6 | | | | | | | | | | | | | | | | | | |
| enumeration | 7 | | | | | | | | | | | | | | | | | | |

element Intervento_Risparmio_Energetico_Type/Spesa

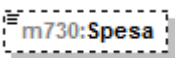
| diagram |  | | | | |
|-----------|---|------|-------|---------|----------------|
| namespace | urn:www.agenziaentrate.gov.it:specificheTecniche:sco:730 | | | | |
| type | DatoNP_Type | | | | |
| facets | <table border="1"> <thead> <tr> <th>Kind</th> <th>Value</th> </tr> </thead> <tbody> <tr> <td>pattern</td> <td>[1-9]{1}[0-9]*</td> </tr> </tbody> </table> | Kind | Value | pattern | [1-9]{1}[0-9]* |
| Kind | Value | | | | |
| pattern | [1-9]{1}[0-9]* | | | | |

complexType Lavoro_Dipendente_Type

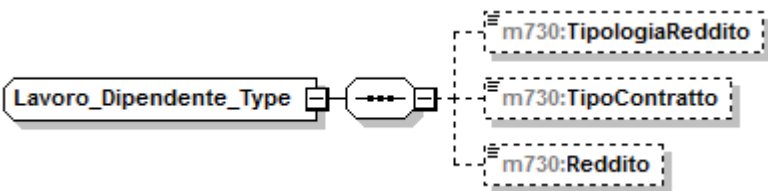
| | |
|-----------|---|
| diagram |  |
| namespace | urn:www.agenziaentrate.gov.it:specificheTecniche:sco:730 |
| children | m730:TipologiaReddito m730:TipoContratto m730:Reddito |

element Lavoro_Dipendente_Type/TipologiaReddito

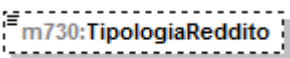
| diagram |  | | | | |
|-----------|--|------|-------|---------|-------|
| namespace | urn:www.agenziaentrate.gov.it:specificheTecniche:sco:730 | | | | |
| type | m730:Tipo_Reddito_Da1a4_Type | | | | |
| facets | <table border="1"> <thead> <tr> <th>Kind</th> <th>Value</th> </tr> </thead> <tbody> <tr> <td>pattern</td> <td>[1-9]</td> </tr> </tbody> </table> | Kind | Value | pattern | [1-9] |
| Kind | Value | | | | |
| pattern | [1-9] | | | | |

| | |
|--|---------------|
| | enumeration 1 |
| | enumeration 2 |
| | enumeration 3 |
| | enumeration 4 |

element Lavoro_Dipendente_Type/TipoContratto

| diagram | | | | | | | | | |
|-------------|--|------|-------|---------|-------|-------------|---|-------------|---|
| namespace | urn:www.agenziaentrate.gov.it:specificheTecniche:sco:730 | | | | | | | | |
| type | m730:Indeterminato_Determinato_Type | | | | | | | | |
| facets | <table border="1"> <thead> <tr> <th>Kind</th> <th>Value</th> </tr> </thead> <tbody> <tr> <td>pattern</td> <td>[1-9]</td> </tr> <tr> <td>enumeration</td> <td>1</td> </tr> <tr> <td>enumeration</td> <td>2</td> </tr> </tbody> </table> | Kind | Value | pattern | [1-9] | enumeration | 1 | enumeration | 2 |
| Kind | Value | | | | | | | | |
| pattern | [1-9] | | | | | | | | |
| enumeration | 1 | | | | | | | | |
| enumeration | 2 | | | | | | | | |

element Lavoro_Dipendente_Type/Reddito

| diagram | | | | | |
|-----------|---|------|-------|---------|----------------|
| namespace | urn:www.agenziaentrate.gov.it:specificheTecniche:sco:730 | | | | |
| type | DatoNP_Type | | | | |
| facets | <table border="1"> <thead> <tr> <th>Kind</th> <th>Value</th> </tr> </thead> <tbody> <tr> <td>pattern</td> <td>[1-9]{1}[0-9]*</td> </tr> </tbody> </table> | Kind | Value | pattern | [1-9]{1}[0-9]* |
| Kind | Value | | | | |
| pattern | [1-9]{1}[0-9]* | | | | |

complexType Misura_Acconti_Type

| | |
|-----------|--|
| diagram | |
| namespace | urn:www.agenziaentrate.gov.it:specificheTecniche:sco:730 |
| children | m730:IrpefMisuralInferiore m730:AddComunaleMisuralInferiore m730:CedolareSeccaMisuralInferiore m730:NumeroRate |

element Misura_Acconti_Type/IrpefMisuralInferiore

| | |
|---------|--|
| diagram | |
|---------|--|

| | |
|-----------|---|
| namespace | urn:www.agenziaentrate.gov.it:specificheTecniche:sco:730 |
| type | m730:Casella_Acconto_Type |
| children | m730:Casella m730:ImportoMisuralInferiore |

element **Misura_Acconti_Type/AddComunaleMisuralInferiore**

| | |
|-----------|---|
| diagram | |
| namespace | urn:www.agenziaentrate.gov.it:specificheTecniche:sco:730 |
| type | m730:Casella_Acconto_Type |
| children | m730:Casella m730:ImportoMisuralInferiore |

element **Misura_Acconti_Type/CedolareSeccaMisuralInferiore**

| | |
|-----------|---|
| diagram | |
| namespace | urn:www.agenziaentrate.gov.it:specificheTecniche:sco:730 |
| type | m730:Casella_Acconto_Type |
| children | m730:Casella m730:ImportoMisuralInferiore |

element **Misura_Acconti_Type/NumeroRate**

| diagram | | | | | | | | | | | | | | | | | |
|-------------|--|------|-------|---------|-------|-------------|---|-------------|---|-------------|---|-------------|---|-------------|---|-------------|---|
| namespace | urn:www.agenziaentrate.gov.it:specificheTecniche:sco:730 | | | | | | | | | | | | | | | | |
| type | restriction of DatoN1_Type | | | | | | | | | | | | | | | | |
| facets | <table border="1"> <thead> <tr> <th>Kind</th> <th>Value</th> </tr> </thead> <tbody> <tr> <td>pattern</td> <td>[1-9]</td> </tr> <tr> <td>enumeration</td> <td>2</td> </tr> <tr> <td>enumeration</td> <td>3</td> </tr> <tr> <td>enumeration</td> <td>4</td> </tr> <tr> <td>enumeration</td> <td>5</td> </tr> <tr> <td>enumeration</td> <td>6</td> </tr> <tr> <td>enumeration</td> <td>7</td> </tr> </tbody> </table> | Kind | Value | pattern | [1-9] | enumeration | 2 | enumeration | 3 | enumeration | 4 | enumeration | 5 | enumeration | 6 | enumeration | 7 |
| Kind | Value | | | | | | | | | | | | | | | | |
| pattern | [1-9] | | | | | | | | | | | | | | | | |
| enumeration | 2 | | | | | | | | | | | | | | | | |
| enumeration | 3 | | | | | | | | | | | | | | | | |
| enumeration | 4 | | | | | | | | | | | | | | | | |
| enumeration | 5 | | | | | | | | | | | | | | | | |
| enumeration | 6 | | | | | | | | | | | | | | | | |
| enumeration | 7 | | | | | | | | | | | | | | | | |

complexType Modulo_Altri_Reddit_Type

| | |
|-----------|---|
| diagram | |
| namespace | urn:www.agenziaentrate.gov.it:specificheTecniche:sco:730 |
| children | m730:RedditiDiCapitale m730:RedditiTassazioneSeparata |

element Modulo_Altri_Reddit_Type/RedditiDiCapitale

| | |
|-----------|--|
| diagram | |
| namespace | urn:www.agenziaentrate.gov.it:specificheTecniche:sco:730 |
| type | m730:Redditi_Capitale_Type |
| children | m730:Utili m730:AltriRedditiDiCapitale m730:LavoroAutonomo m730:RedditiDiversi m730:RedditiDiversiDetraz |

element Modulo_Altri_Reddit_Type/RedditiTassazioneSeparata

| | |
|-----------|--|
| diagram | |
| namespace | urn:www.agenziaentrate.gov.it:specificheTecniche:sco:730 |
| type | m730:Redditi_Tassazione_Separata_Type |
| children | m730:RedditiErede m730:ImposteRimborsate |

complexType **Modulo_Crediti_Imposta_Type**

| | |
|-----------|---|
| diagram | |
| namespace | urn:www.agenziaentrate.gov.it:specificheTecniche:sco:730 |
| children | m730:CreditiImpostaFondiPensione m730:CreditiImpostaRedditiEsteri m730:CreditoPrimaCasaSismaAbruzzo m730:CreditoAltriSismaAbruzzo |

element **Modulo_Crediti_Imposta_Type/CreditiImpostaFondiPensione**

| | |
|-----------|--|
| diagram | |
| namespace | urn:www.agenziaentrate.gov.it:specificheTecniche:sco:730 |
| type | m730:Crediti_Imposta_Fondi_Pensione_Type |
| children | m730:AnnoAnticipazione m730:Reintegro m730:SommaReintegrata m730:CreditoAnno |

element **Modulo_Crediti_Imposta_Type/CreditiImpostaRedditiEsteri**

| | |
|------------------|--|
| <p>diagram</p> | |
| <p>namespace</p> | <p>urn:www.agenziaentrate.gov.it:specificheTecniche:sco:730</p> |
| <p>type</p> | <p>m730:Crediti_Imposta_Redditi_Esteri_Type</p> |
| <p>children</p> | <p>m730:StatoEsteri m730:Anno m730:RedditoEsteri m730:ImpostaEstera m730:RedditoComplessivo m730:Imposta_Lorda m730:ImpostaNetta m730:CreditoDichiarazioniPrecedenti m730:DiCuiStatoEsteri</p> |

element **Modulo_Crediti_Imposta_Type/CreditoPrimaCasaSismaAbruzzo**

| | |
|------------------|--|
| <p>diagram</p> | |
| <p>namespace</p> | <p>urn:www.agenziaentrate.gov.it:specificheTecniche:sco:730</p> |
| <p>type</p> | <p>m730:Credito_Immobile_Sisma_Abruzzo_Type</p> |
| <p>children</p> | <p>m730:CodiceFiscale m730:NumeroRata m730:TotaleCredito</p> |

element **Modulo_Crediti_Imposta_Type/CreditoAltriSismaAbruzzo**

| | |
|------------------|--|
| <p>diagram</p> | |
| <p>namespace</p> | <p>urn:www.agenziaentrate.gov.it:specificheTecniche:sco:730</p> |
| <p>type</p> | <p>m730:Crediti_Imposta_Altri_Sisma_Abruzzo_Type</p> |
| <p>children</p> | <p>m730:Impresa_Professione m730:CreditoImmobileSismaAbruzzo m730:Rateazione</p> |

complexType **Modulo_Fabbricato_Type**

| | |
|------------------|---|
| <p>diagram</p> | |
| <p>namespace</p> | <p>urn:www.agenziaentrate.gov.it:specificheTecniche:sco:730</p> |
| <p>children</p> | <p>m730:FabbricatoOrd m730:FabbricatoAgev</p> |

element **Modulo_Fabbricato_Type/FabbricatoOrd**

| | |
|------------------|--|
| <p>diagram</p> | |
| <p>namespace</p> | <p>urn:www.agenziaentrate.gov.it:specificheTecniche:sco:730</p> |
| <p>type</p> | <p>m730:FabbricatoOrd_Type</p> |
| <p>children</p> | <p>m730:Rendita m730:Utilizzo m730:GiorniPossesso m730:PercPossesso m730:CodiceCanone m730:CanoneLocazione m730:CasiParticolari m730:CasellaContinuazione m730:CodiceComune m730:OpzioneCedolare m730:CasellaCasiPartimu</p> |

element **Modulo_Fabbricato_Type/FabbricatoAgev**

| | |
|----------------|--|
| <p>diagram</p> | |
|----------------|--|

| | |
|-----------|---|
| namespace | urn:www.agenziaentrate.gov.it:specificheTecniche:sco:730 |
| type | m730:FabbricatoAgev_Type |
| children | m730:NumeroRigoRiferimento m730:NumModuloRiferimento m730:DatiContratto m730:CasellaInf30Giorni m730:AnnoDichiarazioneIcilmu m730:StatoEmergenza |

complexType **Modulo_Familiari_Type**

| | |
|-----------|--|
| diagram | |
| namespace | urn:www.agenziaentrate.gov.it:specificheTecniche:sco:730 |
| children | m730:Coniuge m730:PrimoFiglio m730:Familiari |

element **Modulo_Familiari_Type/Coniuge**

| | |
|-----------|--|
| diagram | |
| namespace | urn:www.agenziaentrate.gov.it:specificheTecniche:sco:730 |
| type | m730:Dati_Coniuge_Type |
| children | m730:Tipo m730:CodiceFiscale m730:Mesi |

element **Modulo_Familiari_Type/PrimoFiglio**

| | |
|------------------|---|
| <p>diagram</p> | |
| <p>namespace</p> | <p>urn:www.agenziaentrate.gov.it:specificheTecniche:sco:730</p> |
| <p>type</p> | <p>extension of m730:Dati_Familiare_Type</p> |
| <p>children</p> | <p>m730:CodiceFiscale m730:Mesi m730:MesiMinore m730:PercDetraz m730:PercDetrazCon m730:Affidamento m730:Tipo</p> |

element **Modulo_Familiari_Type/PrimoFiglio/Tipo**

| <p>diagram</p> | | | | | | | | | |
|------------------|---|------|-------|---------|--|-------------|---|-------------|---|
| <p>namespace</p> | <p>urn:www.agenziaentrate.gov.it:specificheTecniche:sco:730</p> | | | | | | | | |
| <p>type</p> | <p>restriction of DatoAN_Type</p> | | | | | | | | |
| <p>facets</p> | <table border="1"> <thead> <tr> <th>Kind</th> <th>Value</th> </tr> </thead> <tbody> <tr> <td>pattern</td> <td>([0-9A-Z-] &quot;){1}([0-9A-Z&amp;] ' \\-\\.\\. / ° \\^\\(\\ \\) À É Ì Ò Ù Û &quot; \\N \\+)*</td> </tr> <tr> <td>enumeration</td> <td>F</td> </tr> <tr> <td>enumeration</td> <td>D</td> </tr> </tbody> </table> | Kind | Value | pattern | ([0-9A-Z-] "){1}([0-9A-Z&] ' \\-\\.\\. / ° \\^\\(\\ \\) À É Ì Ò Ù Û " \\N \\+)* | enumeration | F | enumeration | D |
| Kind | Value | | | | | | | | |
| pattern | ([0-9A-Z-] "){1}([0-9A-Z&] ' \\-\\.\\. / ° \\^\\(\\ \\) À É Ì Ò Ù Û " \\N \\+)* | | | | | | | | |
| enumeration | F | | | | | | | | |
| enumeration | D | | | | | | | | |

element **Modulo_Familiari_Type/Familiari**

| | |
|-----------|--|
| diagram | |
| namespace | urn:www.agenziaentrate.gov.it:specificheTecniche:sco:730 |
| type | extension of m730:Dati_Familiare_Type |
| children | m730:CodiceFiscale m730:Mesi m730:MesiMinore m730:PercDetraz m730:PercDetrazCon m730:Affidamento m730:Tipo |

element **Modulo_Familiari_Type/Familiari/Tipo**

| | | | | | | | | | | | |
|-------------|---|------|-------|---------|---|-------------|---|-------------|---|-------------|---|
| diagram | | | | | | | | | | | |
| namespace | urn:www.agenziaentrate.gov.it:specificheTecniche:sco:730 | | | | | | | | | | |
| type | restriction of DatoAN_Type | | | | | | | | | | |
| facets | <table border="0"> <tr> <td>Kind</td> <td>Value</td> </tr> <tr> <td>pattern</td> <td>(([0-9A-Z-] &quot;){1}([0-9A-Z&amp;:] ' \- . \./ ° \\ \\(\\) À É Ï Ò Ù Û &quot; \\N \\+)*</td> </tr> <tr> <td>enumeration</td> <td>F</td> </tr> <tr> <td>enumeration</td> <td>D</td> </tr> <tr> <td>enumeration</td> <td>A</td> </tr> </table> | Kind | Value | pattern | (([0-9A-Z-] "){1}([0-9A-Z&:] ' \- . \./ ° \\ \\(\\) À É Ï Ò Ù Û " \\N \\+)* | enumeration | F | enumeration | D | enumeration | A |
| Kind | Value | | | | | | | | | | |
| pattern | (([0-9A-Z-] "){1}([0-9A-Z&:] ' \- . \./ ° \\ \\(\\) À É Ï Ò Ù Û " \\N \\+)* | | | | | | | | | | |
| enumeration | F | | | | | | | | | | |
| enumeration | D | | | | | | | | | | |
| enumeration | A | | | | | | | | | | |

complexType **Modulo_Lavoro_Dip_Type**

| | |
|-----------|--|
| diagram | |
| namespace | urn:www.agenziaentrate.gov.it:specificheTecniche:sco:730 |
| children | m730:LavoroDipendente m730:AltriRedditiAssLavDip |

element **Modulo_Lavoro_Dip_Type/LavoroDipendente**

| | |
|-----------|---|
| diagram | |
| namespace | urn:www.agenziaentrate.gov.it:specificheTecniche:sco:730 |
| type | m730:Lavoro_Dipendente_Type |
| children | m730:TipologiaReddito m730:TipoContratto m730:Reddito |

element **Modulo_Lavoro_Dip_Type/AltriRedditiAssLavDip**

| | |
|-----------|--|
| diagram | |
| namespace | urn:www.agenziaentrate.gov.it:specificheTecniche:sco:730 |
| type | m730:Altri_Redditi_Ass_Lavd_Type |
| children | m730:AssegnoDelConiuge m730:ImportoRedditoAssimilato |

complexType **Modulo_Oneri_Type**

| | |
|------------------|--|
| <p>diagram</p> | |
| <p>namespace</p> | <p>urn:www.agenziaentrate.gov.it:specificheTecniche:sco:730</p> |
| <p>children</p> | <p>m730:SpeseDetrazioni m730:SpeseDeduzioni m730:InterventoRecuperoPatrimonioEdilizio m730:DatiCatastaliRecuperoPatrimonioEdilizio m730:InterventoRisparmioEnergetico m730:CanoniLocazione m730:DatiAltreDetrazioni m730:SpeseArredo</p> |

element **Modulo_Oneri_Type/SpeseDetrazioni**

| | |
|------------------|---|
| <p>diagram</p> | |
| <p>namespace</p> | <p>urn:www.agenziaentrate.gov.it:specificheTecniche:sco:730</p> |
| <p>type</p> | <p>m730:Detrazioni_Modulo_Type</p> |
| <p>children</p> | <p>m730:VeicoliDisabili m730:AcquistoCaniGuida m730:SpeseRateizzate m730:AltreSpese</p> |

element **Modulo_Oneri_Type/SpeseDeduzioni**

| | |
|-----------|---|
| diagram | |
| namespace | urn:www.agenziaentrate.gov.it:specificheTecniche:sco:730 |
| type | m730:Deduzioni_Modulo_Type |
| children | m730:AssegnoConiuge m730:AltriOneri m730:AcquistoCostruzioneAbitLocazione |

element **Modulo_Oneri_Type/InterventoRecuperoPatrimonioEdilizio**

| | |
|-----------|--|
| diagram | |
| namespace | urn:www.agenziaentrate.gov.it:specificheTecniche:sco:730 |
| type | m730:Intervento Recupero Patrimonio Edilizio Type |
| children | m730:Anno m730:Periodo m730:CodiceFiscale m730:CasellaInterventiParticolari m730:CodiceSituazioniParticolari m730:AnnoSituazioniParticolari m730:RideterminazioneRate m730:NRate m730:Spesa m730:NOrdineImmobile |

element **Modulo_Oneri_Type/DatiCatastaliRecuperoPatrimonioEdilizio**

| | |
|-----------|---|
| diagram | |
| namespace | urn:www.agenziaentrate.gov.it:specificheTecniche:sco:730 |
| type | m730:Sezione Dati Catastali Recupero Patrimonio Edilizio Type |
| children | m730:DatiCatastaliRecuperoPatrimonioEdilizio m730:DatiRegistrazioneAccatastamentoRecuperoPatrimonio Edilizio |

element **Modulo_Oneri_Type/InterventoRisparmioEnergetico**

| | |
|-----------|---|
| diagram | |
| namespace | urn:www.agenziaentrate.gov.it:specificheTecniche:sco:730 |
| type | m730:Intervento Risparmio Energetico Type |
| children | m730:TipoIntervento m730:Anno m730:Periodo2013 m730:CasiParticolari m730:RideterminazioneRate m730:RipartizioneRate m730:NumeroRata m730:Spesa |

element **Modulo_Oneri_Type/CanoniLocazione**

| | |
|-----------|--|
| diagram | |
| namespace | urn:www.agenziaentrate.gov.it:specificheTecniche:sco:730 |
| type | m730:Detrazioni Canoni Locazione Type |
| children | m730:InquiliniAbitazionePrincipale m730:DipendentiTrasferiti |

element **Modulo_Oneri_Type/DatiAltreDetrazioni**

| | |
|-----------|--|
| diagram | |
| namespace | urn:www.agenziaentrate.gov.it:specificheTecniche:sco:730 |
| type | m730:Dati Altre Detrazioni Modulo Type |
| children | m730:AltreDetrazioni |

element **Modulo_Oneri_Type/SpeseArredo**

| | |
|-----------|--|
| diagram | |
| namespace | urn:www.agenziaentrate.gov.it:specificheTecniche:sco:730 |
| type | m730:Spese Arredo Type |
| children | m730:NumeroRata m730:Importo |

complexType **Modulo_PL_Type**

| | |
|-----------|--|
| diagram | |
| namespace | urn:www.agenziaentrate.gov.it:specificheTecniche:sco:730 |
| children | m730:CredImpEstero |

element **Modulo_PL_Type/CredImpEestero**

| | |
|------------------|--|
| <p>diagram</p> | |
| <p>namespace</p> | <p>urn:www.agenziaentrate.gov.it:specificheTecniche:sco:730</p> |
| <p>type</p> | <p>m730:Cred_Imp_Estero_Type</p> |
| <p>children</p> | <p>m730:Anno m730:TotCredito m730:CreditoStato</p> |

complexType **Modulo_Terreno_Type**

| | |
|------------------|---|
| <p>diagram</p> | |
| <p>namespace</p> | <p>urn:www.agenziaentrate.gov.it:specificheTecniche:sco:730</p> |
| <p>children</p> | <p>m730:Terreno</p> |

element **Modulo_Terreno_Type/Terreno**

| | |
|------------------|--|
| <p>diagram</p> | |
| <p>namespace</p> | <p>urn:www.agenziaentrate.gov.it:specificheTecniche:sco:730</p> |
| <p>type</p> | <p>m730:Terreno_Type</p> |
| <p>children</p> | <p>m730:RedDominicale m730:Titolo m730:RedAgrario m730:GiorniPossesso m730:PercPossesso m730:CanoneVincolistico m730:CasiParticolari m730:CasellaContinuazione m730:CasellalmuNonDovuta m730:CasellaColtivatoreDiretto</p> |

complexType **N_Rate_Type**

| | |
|------------------|---|
| <p>diagram</p> | |
| <p>namespace</p> | <p>urn:www.agenziaentrate.gov.it:specificheTecniche:sco:730</p> |
| <p>children</p> | <p>m730:Rate5 m730:Rate10</p> |

element **N_Rate_Type/Rate5**

| <p>diagram</p> | | | | | |
|------------------|---|------|-------|---------|----------------|
| <p>namespace</p> | <p>urn:www.agenziaentrate.gov.it:specificheTecniche:sco:730</p> | | | | |
| <p>type</p> | <p>m730:Rate5_Type</p> | | | | |
| <p>facets</p> | <table border="1"> <thead> <tr> <th>Kind</th> <th>Value</th> </tr> </thead> <tbody> <tr> <td>pattern</td> <td>[1-9]{1}[0-9]*</td> </tr> </tbody> </table> | Kind | Value | pattern | [1-9]{1}[0-9]* |
| Kind | Value | | | | |
| pattern | [1-9]{1}[0-9]* | | | | |

| | |
|-------------|---|
| enumeration | 4 |
| enumeration | 5 |

element N Rate_Type/Rate10

| diagram | | | | | | | | | | | | | | | | | | | | | | | | | |
|-------------|--|------|-------|---------|----------------|-------------|---|-------------|---|-------------|---|-------------|---|-------------|---|-------------|---|-------------|---|-------------|---|-------------|---|-------------|----|
| namespace | urn:www.agenziaentrate.gov.it:specificheTecniche:sco:730 | | | | | | | | | | | | | | | | | | | | | | | | |
| type | m730:Rate10_Type | | | | | | | | | | | | | | | | | | | | | | | | |
| facets | <table border="1"> <thead> <tr> <th>Kind</th> <th>Value</th> </tr> </thead> <tbody> <tr> <td>pattern</td> <td>[1-9]{1}[0-9]*</td> </tr> <tr> <td>enumeration</td> <td>1</td> </tr> <tr> <td>enumeration</td> <td>2</td> </tr> <tr> <td>enumeration</td> <td>3</td> </tr> <tr> <td>enumeration</td> <td>4</td> </tr> <tr> <td>enumeration</td> <td>5</td> </tr> <tr> <td>enumeration</td> <td>6</td> </tr> <tr> <td>enumeration</td> <td>7</td> </tr> <tr> <td>enumeration</td> <td>8</td> </tr> <tr> <td>enumeration</td> <td>9</td> </tr> <tr> <td>enumeration</td> <td>10</td> </tr> </tbody> </table> | Kind | Value | pattern | [1-9]{1}[0-9]* | enumeration | 1 | enumeration | 2 | enumeration | 3 | enumeration | 4 | enumeration | 5 | enumeration | 6 | enumeration | 7 | enumeration | 8 | enumeration | 9 | enumeration | 10 |
| Kind | Value | | | | | | | | | | | | | | | | | | | | | | | | |
| pattern | [1-9]{1}[0-9]* | | | | | | | | | | | | | | | | | | | | | | | | |
| enumeration | 1 | | | | | | | | | | | | | | | | | | | | | | | | |
| enumeration | 2 | | | | | | | | | | | | | | | | | | | | | | | | |
| enumeration | 3 | | | | | | | | | | | | | | | | | | | | | | | | |
| enumeration | 4 | | | | | | | | | | | | | | | | | | | | | | | | |
| enumeration | 5 | | | | | | | | | | | | | | | | | | | | | | | | |
| enumeration | 6 | | | | | | | | | | | | | | | | | | | | | | | | |
| enumeration | 7 | | | | | | | | | | | | | | | | | | | | | | | | |
| enumeration | 8 | | | | | | | | | | | | | | | | | | | | | | | | |
| enumeration | 9 | | | | | | | | | | | | | | | | | | | | | | | | |
| enumeration | 10 | | | | | | | | | | | | | | | | | | | | | | | | |

complexType Oneri_Non_Abbattuti_Type

| | |
|-----------|--|
| diagram | |
| namespace | urn:www.agenziaentrate.gov.it:specificheTecniche:sco:730 |
| children | m730:DetrazSpeseAssPersonale m730:DetrazErogazBiennaleVenezia m730:DetrazErogazSpettacolo m730:DetrazErogazSettoreMusicale m730:DeduzContributiPaesiSviluppo m730:DeduzOnlus m730:DetrazOspedaleGalliera m730:PrevidenzaCompIDipPubblici m730:InteressiMutuiAgrari m730:ArtBonus |

element **Oneri_Non_Abbattuti_Type/DetrazSpeseAssPersonale**

| | |
|-----------|--|
| diagram |  m730:DetrazSpeseAssPersonale |
| namespace | urn:www.agenziaentrate.gov.it:specificheTecniche:sco:730 |
| type | DatoNP_Type |
| facets | Kind Value pattern [1-9]{1}[0-9]* |

element **Oneri_Non_Abbattuti_Type/DetrazErogazBiennaleVenezia**

| | |
|-----------|---|
| diagram |  m730:DetrazErogazBiennaleVen... |
| namespace | urn:www.agenziaentrate.gov.it:specificheTecniche:sco:730 |
| type | DatoNP_Type |
| facets | Kind Value pattern [1-9]{1}[0-9]* |

element **Oneri_Non_Abbattuti_Type/DetrazErogazSpettacolo**

| | |
|-----------|---|
| diagram |  m730:DetrazErogazSpettacolo |
| namespace | urn:www.agenziaentrate.gov.it:specificheTecniche:sco:730 |
| type | DatoNP_Type |
| facets | Kind Value pattern [1-9]{1}[0-9]* |

element **Oneri_Non_Abbattuti_Type/DetrazErogazSettoreMusicale**

| | |
|-----------|---|
| diagram |  m730:DetrazErogazSettoreMusi... |
| namespace | urn:www.agenziaentrate.gov.it:specificheTecniche:sco:730 |
| type | DatoNP_Type |
| facets | Kind Value pattern [1-9]{1}[0-9]* |

element **Oneri_Non_Abbattuti_Type/DeduzContributiPaesiSviluppo**

| | |
|-----------|---|
| diagram |  m730:DeduzContributiPaesiSvilu... |
| namespace | urn:www.agenziaentrate.gov.it:specificheTecniche:sco:730 |
| type | DatoNP_Type |
| facets | Kind Value pattern [1-9]{1}[0-9]* |

element **Oneri_Non_Abbattuti_Type/DeduzOnlus**

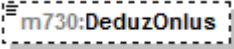
| | | | | | |
|-----------|---|------|-------|---------|----------------|
| diagram |  | | | | |
| namespace | urn:www.agenziaentrate.gov.it:specificheTecniche:sco:730 | | | | |
| type | DatoNP_Type | | | | |
| facets | <table border="1"> <tr> <td>Kind</td> <td>Value</td> </tr> <tr> <td>pattern</td> <td>[1-9]{1}[0-9]*</td> </tr> </table> | Kind | Value | pattern | [1-9]{1}[0-9]* |
| Kind | Value | | | | |
| pattern | [1-9]{1}[0-9]* | | | | |

element **Oneri_Non_Abbattuti_Type/DetrazOspedaleGalliera**

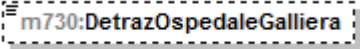
| | | | | | |
|-----------|---|------|-------|---------|----------------|
| diagram |  | | | | |
| namespace | urn:www.agenziaentrate.gov.it:specificheTecniche:sco:730 | | | | |
| type | DatoNP_Type | | | | |
| facets | <table border="1"> <tr> <td>Kind</td> <td>Value</td> </tr> <tr> <td>pattern</td> <td>[1-9]{1}[0-9]*</td> </tr> </table> | Kind | Value | pattern | [1-9]{1}[0-9]* |
| Kind | Value | | | | |
| pattern | [1-9]{1}[0-9]* | | | | |

element **Oneri_Non_Abbattuti_Type/PrevidenzaComplDipPubblici**

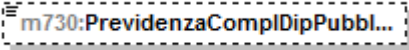
| | | | | | |
|-----------|---|------|-------|---------|----------------|
| diagram |  | | | | |
| namespace | urn:www.agenziaentrate.gov.it:specificheTecniche:sco:730 | | | | |
| type | DatoNP_Type | | | | |
| facets | <table border="1"> <tr> <td>Kind</td> <td>Value</td> </tr> <tr> <td>pattern</td> <td>[1-9]{1}[0-9]*</td> </tr> </table> | Kind | Value | pattern | [1-9]{1}[0-9]* |
| Kind | Value | | | | |
| pattern | [1-9]{1}[0-9]* | | | | |

element **Oneri_Non_Abbattuti_Type/InteressiMutuiAgrari**

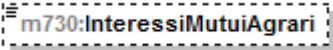
| | | | | | |
|-----------|---|------|-------|---------|----------------|
| diagram |  | | | | |
| namespace | urn:www.agenziaentrate.gov.it:specificheTecniche:sco:730 | | | | |
| type | DatoNP_Type | | | | |
| facets | <table border="1"> <tr> <td>Kind</td> <td>Value</td> </tr> <tr> <td>pattern</td> <td>[1-9]{1}[0-9]*</td> </tr> </table> | Kind | Value | pattern | [1-9]{1}[0-9]* |
| Kind | Value | | | | |
| pattern | [1-9]{1}[0-9]* | | | | |

element **Oneri_Non_Abbattuti_Type/ArtBonus**

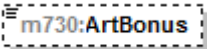
| | | | | | |
|-----------|---|------|-------|---------|----------------|
| diagram |  | | | | |
| namespace | urn:www.agenziaentrate.gov.it:specificheTecniche:sco:730 | | | | |
| type | DatoNP_Type | | | | |
| facets | <table border="1"> <tr> <td>Kind</td> <td>Value</td> </tr> <tr> <td>pattern</td> <td>[1-9]{1}[0-9]*</td> </tr> </table> | Kind | Value | pattern | [1-9]{1}[0-9]* |
| Kind | Value | | | | |
| pattern | [1-9]{1}[0-9]* | | | | |

complexType **Oneri_Type**

| | |
|-----------|--|
| diagram | |
| namespace | urn:www.agenziaentrate.gov.it:specificheTecniche:sco:730 |
| children | m730:PrimoModulo m730:Modulo |

element **Oneri_Type/PrimoModulo**

| | |
|-----------|--|
| diagram | |
| namespace | urn:www.agenziaentrate.gov.it:specificheTecniche:sco:730 |
| type | m730:PrimoModulo_Oneri_Type |
| children | m730:SpeseDetrazioni m730:SpeseDeduzioni m730:InterventoRecuperoPatrimonioEdilizio m730:DatiCatastaliRecuperoPatrimonioEdilizio m730:InterventoRisparmioEnergetico m730:CanoniLocazione m730:DatiAltreDetrazioni m730:OneriNonAbbattuti m730:SpeseArredo |

element **Oneri_Type/Modulo**

| | |
|------------------|--|
| <p>diagram</p> | |
| <p>namespace</p> | <p>urn:www.agenziaentrate.gov.it:specificheTecniche:sco:730</p> |
| <p>type</p> | <p>m730:Modulo_Oneri_Type</p> |
| <p>children</p> | <p>m730:SpeseDetrazioni m730:SpeseDeduzioni m730:InterventoRecuperoPatrimonioEdilizio m730:DatiCatastaliRecuperoPatrimonioEdilizio m730:InterventoRisparmioEnergetico m730:CanoniLocazione m730:DatiAltreDetrazioni m730:SpeseArredo</p> |

complexType **Opzione_Produttivita_Type**

| | |
|------------------|---|
| <p>diagram</p> | |
| <p>namespace</p> | <p>urn:www.agenziaentrate.gov.it:specificheTecniche:sco:730</p> |

complexType **Periodo_Di_Lavoro_Type**

| | |
|------------------|--|
| <p>diagram</p> | |
| <p>namespace</p> | <p>urn:www.agenziaentrate.gov.it:specificheTecniche:sco:730</p> |
| <p>children</p> | <p>m730:GiorniLavoroDipendente m730:GiorniPensione</p> |

element **Periodo_Di_Lavoro_Type/GiorniLavoroDipendente**

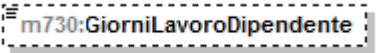
| | |
|-----------|--|
| diagram |  |
| namespace | urn:www.agenziaentrate.gov.it:specificheTecniche:sco:730 |
| type | DatoGA_Type |
| facets | Kind Value pattern [1-9](((1-9)[0-9]) ((12)[0-9][0-9]) (3[0-5][0-9]) (36[0-5])) |

element **Periodo_Di_Lavoro_Type/GiorniPensione**

| | |
|-----------|--|
| diagram |  |
| namespace | urn:www.agenziaentrate.gov.it:specificheTecniche:sco:730 |
| type | DatoGA_Type |
| facets | Kind Value pattern [1-9](((1-9)[0-9]) ((12)[0-9][0-9]) (3[0-5][0-9]) (36[0-5])) |

complexType **Primo_Modulo_Acconti_Ritenute_Type**

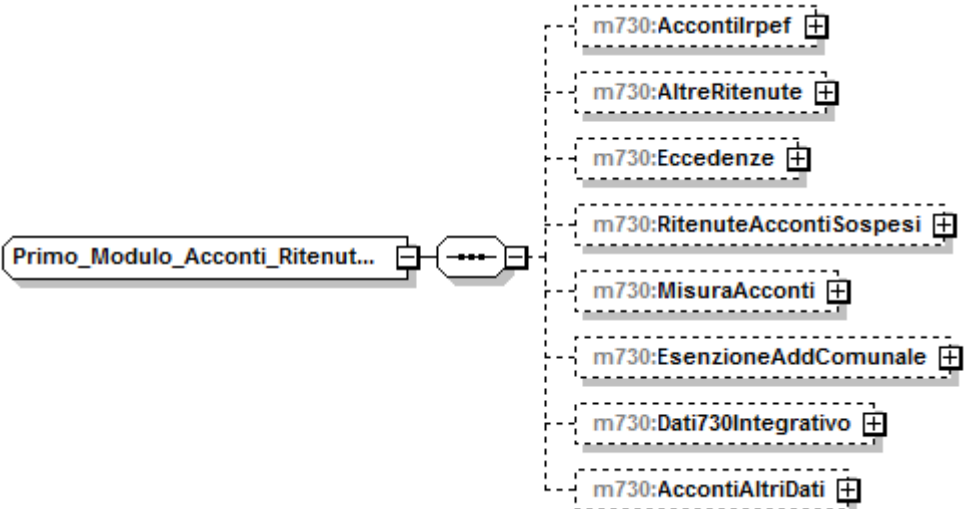
| | |
|-----------|--|
| diagram |  |
| namespace | urn:www.agenziaentrate.gov.it:specificheTecniche:sco:730 |
| children | m730:Accontilrpef m730:AltreRitenute m730:Eccedenze m730:RitenuteAccontiSospesi m730:MisuraAcconti m730:EsenzioneAddComunale m730:Dati730Integrativo m730:AccontiAltriDati |

element **Primo_Modulo_Acconti_Ritenute_Type/Accontilrpef**

| | |
|------------------|--|
| <p>diagram</p> | |
| <p>namespace</p> | <p>urn:www.agenziaentrate.gov.it:specificheTecniche:sco:730</p> |
| <p>type</p> | <p>m730:Acconti_Irpef_Anno_Imposta_Type</p> |
| <p>children</p> | <p>m730:PrimaRataAccontolrpef m730:SecondaRataAccontolrpef m730:AccontoAddComunale m730:AccontoAddComunaleF24 m730:PrimaRataAccontoCedolare m730:SecondaRataAccontoCedolare</p> |

element **Primo_Modulo_Acconti_Ritenute_Type/AltreRitenute**

| | |
|------------------|---|
| <p>diagram</p> | |
| <p>namespace</p> | <p>urn:www.agenziaentrate.gov.it:specificheTecniche:sco:730</p> |
| <p>type</p> | <p>m730:Altre_Ritenute_Type</p> |
| <p>children</p> | <p>m730:AltreRitenutelrpef m730:AddizionaleRegionale m730:AddizionaleComunale m730:AddRegionaleIrpefAttivitaSport m730:AddComunaleIrpefAttivitaSport m730:IrpefLavoriSocialmenteUtili m730:AddRegionaleIrpefLavoriSoc Utili</p> |

element **Primo_Modulo_Acconti_Ritenute_Type/Eccedenze**

| | |
|------------------|---|
| <p>diagram</p> | |
| <p>namespace</p> | <p>urn:www.agenziaentrate.gov.it:specificheTecniche:sco:730</p> |
| <p>type</p> | <p>m730:Eccedenze_Type</p> |
| <p>children</p> | <p>m730:Irpef m730:IrpefCompF24 m730:SostitutivaQuadroRT m730:SostitutivaQuadroRTcompF24 m730:CedolareSecca m730:CedolareSeccaCompF24 m730:CodiceRegione m730:AddRegionaleIrpef m730:AddRegionaleIrpefCompF24 m730:CodiceCatastaleComune m730:AddComunaleIrpef m730:AddComunaleIrpefF24</p> |

element **Primo Modulo Acconti Ritenute Type/RitenuteAccontiSospesi**

| | |
|-----------|---|
| diagram | |
| namespace | urn:www.agenziaentrate.gov.it:specificheTecniche:sco:730 |
| type | m730:Ritenute_Acconti_Sospesi_Type |
| children | m730:CodiceEvento m730:Irpef m730:AddRegionaleIrpef m730:AddComunaleIrpef m730:SostitutivaProduttivita m730:CedolareSecca m730:ContribSolidarieta |

element **Primo Modulo Acconti Ritenute Type/MisuraAcconti**

| | |
|-----------|--|
| diagram | |
| namespace | urn:www.agenziaentrate.gov.it:specificheTecniche:sco:730 |
| type | m730:Misura_Acconti_Type |
| children | m730:IrpefMisuralInferiore m730:AddComunaleMisuralInferiore m730:CedolareSeccaMisuralInferiore m730:NumeroRate |

element **Primo_Modulo_Acconti_Ritenute_Type/EsenzioneAddComunale**

| | |
|-----------|---|
| diagram | |
| namespace | urn:www.agenziaentrate.gov.it:specificheTecniche:sco:730 |
| type | m730:Esenzione Add Comunale Type |
| children | m730:SogliaEsenzioneSaldo m730:SogliaEsenzioneAcconto |

element **Primo_Modulo_Acconti_Ritenute_Type/Dati730Integrativo**

| | |
|-----------|--|
| diagram | |
| namespace | urn:www.agenziaentrate.gov.it:specificheTecniche:sco:730 |
| type | m730:Dati 730Integrativo Type |
| children | m730:Rimborso m730:Credito |

element **Primo_Modulo_Acconti_Ritenute_Type/AccontiAltriDati**

| | |
|-----------|---|
| diagram | |
| namespace | urn:www.agenziaentrate.gov.it:specificheTecniche:sco:730 |
| type | m730:Acconti Altri Dati Type |
| children | m730:IncapientiDetrazioneFigli m730:IncapientiDetrazioneLocazione m730:RestituzioneBonusFiscale m730:RestituzioneBonusStraordinario m730:Pignoramento |

complexType **Primo_Modulo_Crediti_Imposta_Type**

| | |
|------------------|--|
| <p>diagram</p> | |
| <p>namespace</p> | <p>urn:www.agenziaentrate.gov.it:specificheTecniche:sco:730</p> |
| <p>children</p> | <p>m730:CreditiImpostaFabbri... m730:CreditiImpostaFondiPens... m730:CreditiImpostaRedditiEst... m730:CreditoPrimaCasaSismaAbruzzo m730:CreditoAltriSismaAbruzzo m730:CreditoIncrementoOccupazione m730:CreditoImpostaMediazioni m730:CreditoErogazioniCultura</p> |

element **Primo_Modulo_Crediti_Imposta_Type/CreditiImpostaFabbri...**

| | |
|------------------|---|
| <p>diagram</p> | |
| <p>namespace</p> | <p>urn:www.agenziaentrate.gov.it:specificheTecniche:sco:730</p> |
| <p>type</p> | <p>m730:Crediti_Imposta_Fabbriati_Type</p> |
| <p>children</p> | <p>m730:ResiduoFabbriati m730:CanoniLocazioneNonPercepiti</p> |

element **Primo_Modulo_Crediti_Imposta_Type/CreditImpostaFondiPensione**

| | |
|-----------|---|
| diagram | |
| namespace | urn:www.agenziaentrate.gov.it:specificheTecniche:sco:730 |
| type | extension of m730:Crediti_Imposta_Fondi_Pensione_Type |
| children | m730:AnnoAnticipazione m730:Reintegro m730:SommaReintegrata m730:CreditoAnno m730:ResiduoPrecedenteDichiarazione m730:DiCuiCompensatoF24 |

element

Primo_Modulo_Crediti_Imposta_Type/CreditImpostaFondiPensione/ResiduoPrecedenteDichiarazione

| diagram | | | | | |
|-----------|---|------|-------|---------|----------------|
| namespace | urn:www.agenziaentrate.gov.it:specificheTecniche:sco:730 | | | | |
| type | DatoNP_Type | | | | |
| facets | <table border="1"> <thead> <tr> <th>Kind</th> <th>Value</th> </tr> </thead> <tbody> <tr> <td>pattern</td> <td>[1-9]{1}[0-9]*</td> </tr> </tbody> </table> | Kind | Value | pattern | [1-9]{1}[0-9]* |
| Kind | Value | | | | |
| pattern | [1-9]{1}[0-9]* | | | | |

element **Primo_Modulo_Crediti_Imposta_Type/CreditImpostaFondiPensione/DiCuiCompensatoF24**

| diagram | | | | | |
|-----------|---|------|-------|---------|----------------|
| namespace | urn:www.agenziaentrate.gov.it:specificheTecniche:sco:730 | | | | |
| type | DatoNP_Type | | | | |
| facets | <table border="1"> <thead> <tr> <th>Kind</th> <th>Value</th> </tr> </thead> <tbody> <tr> <td>pattern</td> <td>[1-9]{1}[0-9]*</td> </tr> </tbody> </table> | Kind | Value | pattern | [1-9]{1}[0-9]* |
| Kind | Value | | | | |
| pattern | [1-9]{1}[0-9]* | | | | |

element **Primo_Modulo_Crediti_Imposta_Type/CreditiImpostaRedditiEsteri**

| | |
|------------------|--|
| <p>diagram</p> | |
| <p>namespace</p> | <p>urn:www.agenziaentrate.gov.it:specificheTecniche:sco:730</p> |
| <p>type</p> | <p>m730:Crediti_Imposta_Redditi_Esteri_Type</p> |
| <p>children</p> | <p>m730:StatoEstero m730:Anno m730:RedditoEstero m730:ImpostaEstera m730:RedditoComplessivo m730:Imposta_Lorda m730:ImpostaNetta m730:CreditoDichiarazioniPrecedenti m730:DiCuiStatoEstero</p> |

element **Primo_Modulo_Crediti_Imposta_Type/CreditoPrimaCasaSismaAbruzzo**

| | |
|------------------|--|
| <p>diagram</p> | |
| <p>namespace</p> | <p>urn:www.agenziaentrate.gov.it:specificheTecniche:sco:730</p> |
| <p>type</p> | <p>extension of m730:Credito_Immibile_Sisma_Abruzzo_Type</p> |
| <p>children</p> | <p>m730:CodiceFiscale m730:NumeroRata m730:TotaleCredito m730:ResiduoPrecedenteDichiarazione</p> |

element

Primo_Modulo_Crediti_Imposta_Type/CreditoPrimaCasaSismaAbruzzo/ResiduoPrecedenteDichiarazione

| | |
|-----------|--|
| diagram | |
| namespace | urn:www.agenziaentrate.gov.it:specificheTecniche:sco:730 |
| type | DatoNP_Type |
| facets | Kind Value pattern [1-9]{1}[0-9]* |

element Primo_Modulo_Crediti_Imposta_Type/CreditoAltriSismaAbruzzo

| | |
|-----------|---|
| diagram | |
| namespace | urn:www.agenziaentrate.gov.it:specificheTecniche:sco:730 |
| type | m730:Crediti_Imposta_Altri_Sisma_Abruzzo_Type |
| children | m730:Impresa_Professione m730:CreditoImmobileSismaAbruzzo m730:Rateazione |

element Primo_Modulo_Crediti_Imposta_Type/CreditoIncrementoOccupazione

| | |
|-----------|---|
| diagram | |
| namespace | urn:www.agenziaentrate.gov.it:specificheTecniche:sco:730 |
| children | m730:ResiduoPrecedenteDichiarazione m730:DiCuiCompensatoF24 |

element

Primo_Modulo_Crediti_Imposta_Type/CreditoIncrementoOccupazione/ResiduoPrecedenteDichiarazione

| | |
|-----------|--|
| diagram | |
| namespace | urn:www.agenziaentrate.gov.it:specificheTecniche:sco:730 |
| type | DatoNP_Type |
| facets | Kind Value pattern [1-9]{1}[0-9]* |

element **Primo_Modulo_Crediti_Imposta_Type/CreditoIncrementoOccupazione/DiCuiCompensatoF24**

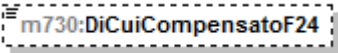
| diagram |  | | | | |
|-----------|---|------|-------|---------|----------------|
| namespace | urn:www.agenziaentrate.gov.it:specificheTecniche:sco:730 | | | | |
| type | DatoNP_Type | | | | |
| facets | <table border="1"> <thead> <tr> <th>Kind</th> <th>Value</th> </tr> </thead> <tbody> <tr> <td>pattern</td> <td>[1-9]{1}[0-9]*</td> </tr> </tbody> </table> | Kind | Value | pattern | [1-9]{1}[0-9]* |
| Kind | Value | | | | |
| pattern | [1-9]{1}[0-9]* | | | | |

element **Primo_Modulo_Crediti_Imposta_Type/CreditoImpostaMediazioni**

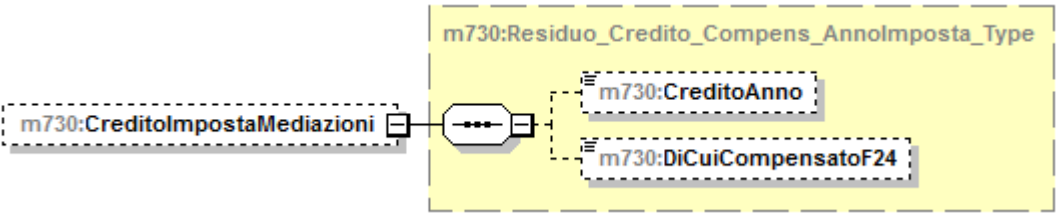
| | |
|-----------|--|
| diagram |  |
| namespace | urn:www.agenziaentrate.gov.it:specificheTecniche:sco:730 |
| type | m730:Residuo_Credito_Compens_AnnolImposta_Type |
| children | m730:CreditoAnno m730:DiCuiCompensatoF24 |

element **Primo_Modulo_Crediti_Imposta_Type/CreditoErogazioniCultura**

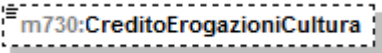
| diagram |  | | | | |
|-----------|---|------|-------|---------|----------------|
| namespace | urn:www.agenziaentrate.gov.it:specificheTecniche:sco:730 | | | | |
| type | DatoNP_Type | | | | |
| facets | <table border="1"> <thead> <tr> <th>Kind</th> <th>Value</th> </tr> </thead> <tbody> <tr> <td>pattern</td> <td>[1-9]{1}[0-9]*</td> </tr> </tbody> </table> | Kind | Value | pattern | [1-9]{1}[0-9]* |
| Kind | Value | | | | |
| pattern | [1-9]{1}[0-9]* | | | | |

complexType **Primo_Modulo_Lavoro_Dip_Type**

| | |
|------------------|--|
| <p>diagram</p> | |
| <p>namespace</p> | <p>urn:www.agenziaentrate.gov.it:specificheTecniche:sco:730</p> |
| <p>children</p> | <p>m730:LavoroDipendente m730:IncrementoProduttivita m730:PeriodoLavoro m730:AltriRedditiAssLavDip m730:RitenuteLavoroDipendente m730:BonusIrpel m730:RedditoAlNettoContribPensioni m730:ContribSolidarietaTrattenuato m730:CasellaCasiParticolari</p> |

element **Primo_Modulo_Lavoro_Dip_Type/LavoroDipendente**

| | |
|------------------|--|
| <p>diagram</p> | |
| <p>namespace</p> | <p>urn:www.agenziaentrate.gov.it:specificheTecniche:sco:730</p> |
| <p>type</p> | <p>m730:Lavoro_Dipendente_Type</p> |
| <p>children</p> | <p>m730:TipologiaReddito m730:TipoContratto m730:Reddito</p> |

element **Primo_Modulo_Lavoro_Dip_Type/IncrementoProduttivita**

| | |
|-----------|--|
| diagram | |
| namespace | urn:www.agenziaentrate.gov.it:specificheTecniche:sco:730 |
| type | m730:Incremento_Produttivita_Type |
| children | m730:ImportoTassazOrdinaria m730:ImportoImpostaSostitutiva m730:RitenuteImpostaSostitutiva m730:Art51Ordinaria m730:Art51Sostitutiva m730:TassazOrdinaria m730:TassazSostitutiva |

element **Primo_Modulo_Lavoro_Dip_Type/PeriodoLavoro**

| | |
|-----------|---|
| diagram | |
| namespace | urn:www.agenziaentrate.gov.it:specificheTecniche:sco:730 |
| type | m730:Periodo_Di_Lavoro_Type |
| children | m730:GiorniLavoroDipendente m730:GiorniPensione |

element **Primo_Modulo_Lavoro_Dip_Type/AltriRedditiAssLavDip**

| | |
|-----------|--|
| diagram | |
| namespace | urn:www.agenziaentrate.gov.it:specificheTecniche:sco:730 |
| type | m730:Altri_Redditi_Ass_Lavd_Type |

| | |
|----------|--|
| children | m730:AssegnoDelConiuge m730:ImportoRedditoAssimilato |
|----------|--|

element **Primo_Modulo_Lavoro_Dip_Type/RitenuteLavoroDipendente**

| | |
|-----------|--|
| diagram | |
| namespace | urn:www.agenziaentrate.gov.it:specificheTecniche:sco:730 |
| type | m730:Ritenute_Lavoro_Dip_Type |
| children | m730:Ritlrpef m730:RitAddRegionale m730:RitAccAddComunale m730:RitSaldoAddComunale m730:RitAccAddComAnnoPres |

element **Primo_Modulo_Lavoro_Dip_Type/Bonuslrpef**

| | |
|-----------|--|
| diagram | |
| namespace | urn:www.agenziaentrate.gov.it:specificheTecniche:sco:730 |
| type | m730:Bonus_Irpéf_Type |
| children | m730:CodiceBonus m730:BonusErogato |

element **Primo_Modulo_Lavoro_Dip_Type/RedditoAlNettoContribPensioni**

| | | | | | |
|-----------|---|------|-------|---------|----------------|
| diagram | | | | | |
| namespace | urn:www.agenziaentrate.gov.it:specificheTecniche:sco:730 | | | | |
| type | DatoNP_Type | | | | |
| facets | <table border="1"> <tr> <td>Kind</td> <td>Value</td> </tr> <tr> <td>pattern</td> <td>[1-9]{1}[0-9]*</td> </tr> </table> | Kind | Value | pattern | [1-9]{1}[0-9]* |
| Kind | Value | | | | |
| pattern | [1-9]{1}[0-9]* | | | | |

element **Primo_Modulo_Lavoro_Dip_Type/ContribSolidarietaTrattenuto**

| diagram | | | | | |
|-----------|---|------|-------|---------|----------------|
| namespace | urn:www.agenziaentrate.gov.it:specificheTecniche:sco:730 | | | | |
| type | DatoNP_Type | | | | |
| facets | <table border="1"> <thead> <tr> <th>Kind</th> <th>Value</th> </tr> </thead> <tbody> <tr> <td>pattern</td> <td>[1-9]{1}[0-9]*</td> </tr> </tbody> </table> | Kind | Value | pattern | [1-9]{1}[0-9]* |
| Kind | Value | | | | |
| pattern | [1-9]{1}[0-9]* | | | | |

element **Primo_Modulo_Lavoro_Dip_Type/CasellaCasiParticolari**

| diagram | | | | | | | | | | | |
|-------------|---|------|-------|---------|-------|-------------|---|-------------|---|-------------|---|
| namespace | urn:www.agenziaentrate.gov.it:specificheTecniche:sco:730 | | | | | | | | | | |
| type | restriction of DatoN1_Type | | | | | | | | | | |
| facets | <table border="1"> <thead> <tr> <th>Kind</th> <th>Value</th> </tr> </thead> <tbody> <tr> <td>pattern</td> <td>[1-9]</td> </tr> <tr> <td>enumeration</td> <td>1</td> </tr> <tr> <td>enumeration</td> <td>2</td> </tr> <tr> <td>enumeration</td> <td>3</td> </tr> </tbody> </table> | Kind | Value | pattern | [1-9] | enumeration | 1 | enumeration | 2 | enumeration | 3 |
| Kind | Value | | | | | | | | | | |
| pattern | [1-9] | | | | | | | | | | |
| enumeration | 1 | | | | | | | | | | |
| enumeration | 2 | | | | | | | | | | |
| enumeration | 3 | | | | | | | | | | |

complexType **Primo_Modulo_PL_Type**

| | |
|-----------|--|
| diagram | |
| namespace | urn:www.agenziaentrate.gov.it:specificheTecniche:sco:730 |
| children | m730:Prospetto m730:ProspettoRideterminato |

element **Primo_Modulo_PL_Type/Prospetto**

| | |
|------------------|--|
| <p>diagram</p> | |
| <p>namespace</p> | <p>urn:www.agenziaentrate.gov.it:specificheTecniche:sco:730</p> |
| <p>type</p> | <p>extension of m730:Prospetto_Type</p> |
| <p>children</p> | <p>m730:RiepilogoRedditi m730:ImpostaLorda m730:DetrazioniCrediti m730:ImpostaNetta m730:Addizionali m730:CedolareSecca m730:ContributoSolidarieta m730:LiquidazioneImposte m730:AltriDati m730:CredImpEestero m730:DatiCreditiF24</p> |

element **Primo_Modulo_PL_Type/Prospetto/Addizionali**

| | |
|------------------|--|
| <p>diagram</p> | |
| <p>namespace</p> | <p>urn:www.agenziaentrate.gov.it:specificheTecniche:sco:730</p> |
| <p>type</p> | <p>m730:Addizionali_Type</p> |
| <p>children</p> | <p>m730:Imponibile m730:AddRegDovuta m730:AddRegCertif m730:EccedenzaAddReg m730:AddComDovuta m730:AddComCertif m730:EccedenzaAddCom m730:AccontoAddCom m730:AccontoAddComCertif</p> |

element **Primo_Modulo_PL_Type/Prospetto/CedolareSecca**

| | |
|------------------|---|
| <p>diagram</p> | |
| <p>namespace</p> | <p>urn:www.agenziaentrate.gov.it:specificheTecniche:sco:730</p> |
| <p>type</p> | <p>m730:Cedolare_Secca_Type</p> |
| <p>children</p> | <p>m730:CedolareDovuta m730:EccedenzaCedolareSecca m730:AccontoCedolare</p> |

element **Primo_Modulo_PL_Type/Prospetto/ContributoSolidarieta**

| | |
|-----------|---|
| diagram | |
| namespace | urn:www.agenziaentrate.gov.it:specificheTecniche:sco:730 |
| type | m730:Contributo_Solidarieta_Type |
| children | m730:ImponibileContributo m730:ContributoDovuto m730:ContributoCertificaz |

element **Primo_Modulo_PL_Type/Prospetto/LiquidazioneImposte**

| | |
|-----------|---|
| diagram | |
| namespace | urn:www.agenziaentrate.gov.it:specificheTecniche:sco:730 |
| children | m730:EsitoIrpref m730:EsitoAddRegionale m730:EsitoAddComunale m730:PrimaRataAcclrpref m730:SecondaRataAcclrpref m730:AccontoTassSep m730:AccontoAddComunale m730:ImpSostProduct m730:EsitoCedolareSecca m730:PrimaRataAccCedolare m730:SecondaRataAccCedolare m730:ContribSolidarietaDebito |

element Primo_Modulo_PL_Type/Prospetto/LiquidazioneImposte/EsitoIrpef

| | |
|-----------|--|
| diagram | |
| namespace | urn:www.agenziaentrate.gov.it:specificheTecniche:sco:730 |
| type | m730:Esito_Liquidazione_Type |
| children | m730:Credito m730:Debito |

element Primo_Modulo_PL_Type/Prospetto/LiquidazioneImposte/EsitoAddRegionale

| | |
|-----------|---|
| diagram | |
| namespace | urn:www.agenziaentrate.gov.it:specificheTecniche:sco:730 |
| type | extension of m730:Esito_Liquidazione_Type |
| children | m730:Credito m730:Debito m730:CodAddReg |

element Primo_Modulo_PL_Type/Prospetto/LiquidazioneImposte/EsitoAddRegionale/CodAddReg

| diagram | | | | | | | | | | | | | | | | | | | | | | | | | | | | | | | | | | | |
|-------------|---|------|-------|---------|---|-------------|---|-------------|---|-------------|---|-------------|---|-------------|---|-------------|---|-------------|---|-------------|---|-------------|---|-------------|----|-------------|----|-------------|----|-------------|----|-------------|----|-------------|----|
| namespace | urn:www.agenziaentrate.gov.it:specificheTecniche:sco:730 | | | | | | | | | | | | | | | | | | | | | | | | | | | | | | | | | | |
| type | Codice Regione Type | | | | | | | | | | | | | | | | | | | | | | | | | | | | | | | | | | |
| facets | <table border="1"> <thead> <tr> <th>Kind</th> <th>Value</th> </tr> </thead> <tbody> <tr> <td>pattern</td> <td>(([0-9A-Z-] &quot;){1}([0-9A-Z&amp;] ' - \., /° √\(\)\ À É É Ï Ò Ù Û &quot;; \\ / +)*</td> </tr> <tr> <td>enumeration</td> <td>1</td> </tr> <tr> <td>enumeration</td> <td>2</td> </tr> <tr> <td>enumeration</td> <td>3</td> </tr> <tr> <td>enumeration</td> <td>4</td> </tr> <tr> <td>enumeration</td> <td>5</td> </tr> <tr> <td>enumeration</td> <td>6</td> </tr> <tr> <td>enumeration</td> <td>7</td> </tr> <tr> <td>enumeration</td> <td>8</td> </tr> <tr> <td>enumeration</td> <td>9</td> </tr> <tr> <td>enumeration</td> <td>10</td> </tr> <tr> <td>enumeration</td> <td>11</td> </tr> <tr> <td>enumeration</td> <td>12</td> </tr> <tr> <td>enumeration</td> <td>13</td> </tr> <tr> <td>enumeration</td> <td>14</td> </tr> <tr> <td>enumeration</td> <td>15</td> </tr> </tbody> </table> | Kind | Value | pattern | (([0-9A-Z-] "){1}([0-9A-Z&] ' - \., /° √\(\)\ À É É Ï Ò Ù Û "; \\ / +)* | enumeration | 1 | enumeration | 2 | enumeration | 3 | enumeration | 4 | enumeration | 5 | enumeration | 6 | enumeration | 7 | enumeration | 8 | enumeration | 9 | enumeration | 10 | enumeration | 11 | enumeration | 12 | enumeration | 13 | enumeration | 14 | enumeration | 15 |
| Kind | Value | | | | | | | | | | | | | | | | | | | | | | | | | | | | | | | | | | |
| pattern | (([0-9A-Z-] "){1}([0-9A-Z&] ' - \., /° √\(\)\ À É É Ï Ò Ù Û "; \\ / +)* | | | | | | | | | | | | | | | | | | | | | | | | | | | | | | | | | | |
| enumeration | 1 | | | | | | | | | | | | | | | | | | | | | | | | | | | | | | | | | | |
| enumeration | 2 | | | | | | | | | | | | | | | | | | | | | | | | | | | | | | | | | | |
| enumeration | 3 | | | | | | | | | | | | | | | | | | | | | | | | | | | | | | | | | | |
| enumeration | 4 | | | | | | | | | | | | | | | | | | | | | | | | | | | | | | | | | | |
| enumeration | 5 | | | | | | | | | | | | | | | | | | | | | | | | | | | | | | | | | | |
| enumeration | 6 | | | | | | | | | | | | | | | | | | | | | | | | | | | | | | | | | | |
| enumeration | 7 | | | | | | | | | | | | | | | | | | | | | | | | | | | | | | | | | | |
| enumeration | 8 | | | | | | | | | | | | | | | | | | | | | | | | | | | | | | | | | | |
| enumeration | 9 | | | | | | | | | | | | | | | | | | | | | | | | | | | | | | | | | | |
| enumeration | 10 | | | | | | | | | | | | | | | | | | | | | | | | | | | | | | | | | | |
| enumeration | 11 | | | | | | | | | | | | | | | | | | | | | | | | | | | | | | | | | | |
| enumeration | 12 | | | | | | | | | | | | | | | | | | | | | | | | | | | | | | | | | | |
| enumeration | 13 | | | | | | | | | | | | | | | | | | | | | | | | | | | | | | | | | | |
| enumeration | 14 | | | | | | | | | | | | | | | | | | | | | | | | | | | | | | | | | | |
| enumeration | 15 | | | | | | | | | | | | | | | | | | | | | | | | | | | | | | | | | | |

| | |
|-------------|----|
| enumeration | 16 |
| enumeration | 17 |
| enumeration | 18 |
| enumeration | 19 |
| enumeration | 20 |
| enumeration | 21 |

element **Primo_Modulo_PL_Type/Prospetto/LiquidazioneImposte/EsitoAddComunale**

| | |
|-----------|--|
| diagram | |
| namespace | urn:www.agenziaentrate.gov.it:specificheTecniche:sco:730 |
| type | extension of m730:Esito_Liquidazione_Type |
| children | m730:Credito m730:Debito m730:CodiceAddCom |

element **Primo_Modulo_PL_Type/Prospetto/LiquidazioneImposte/EsitoAddComunale/CodiceAddCom**

| diagram | | | | | |
|-----------|--|------|-------|---------|---|
| namespace | urn:www.agenziaentrate.gov.it:specificheTecniche:sco:730 | | | | |
| type | DatoAN_Type | | | | |
| facets | <table border="1"> <tr> <th>Kind</th> <th>Value</th> </tr> <tr> <td>pattern</td> <td>([0-9A-Z\-\]&quot;){1}([0-9A-Z&amp;:] ' \" . / ° \"\\(\) À É È Ì Ò Ù Ú &quot; \\ / +)*</td> </tr> </table> | Kind | Value | pattern | ([0-9A-Z\-\]"){1}([0-9A-Z&:] ' \" . / ° \"\\(\) À É È Ì Ò Ù Ú " \\ / +)* |
| Kind | Value | | | | |
| pattern | ([0-9A-Z\-\]"){1}([0-9A-Z&:] ' \" . / ° \"\\(\) À É È Ì Ò Ù Ú " \\ / +)* | | | | |

element **Primo_Modulo_PL_Type/Prospetto/LiquidazioneImposte/PrimaRataAcclrpef**

| diagram | | | | | |
|-----------|---|------|-------|---------|----------------|
| namespace | urn:www.agenziaentrate.gov.it:specificheTecniche:sco:730 | | | | |
| type | DatoNP_Type | | | | |
| facets | <table border="1"> <tr> <th>Kind</th> <th>Value</th> </tr> <tr> <td>pattern</td> <td>[1-9]{1}[0-9]*</td> </tr> </table> | Kind | Value | pattern | [1-9]{1}[0-9]* |
| Kind | Value | | | | |
| pattern | [1-9]{1}[0-9]* | | | | |

element **Primo_Modulo_PL_Type/Prospetto/LiquidazioneImposte/SecondaRataAcclrpef**

| | |
|-----------|--|
| diagram | |
| namespace | urn:www.agenziaentrate.gov.it:specificheTecniche:sco:730 |
| type | DatoNP_Type |

| | | |
|--------|-----------------|-------------------------|
| facets | Kind pattern | Value [1-9]{1}[0-9]* |
|--------|-----------------|-------------------------|

element **Primo_Modulo_PL_Type/Prospetto/LiquidazioneImposte/AcontoTassSep**

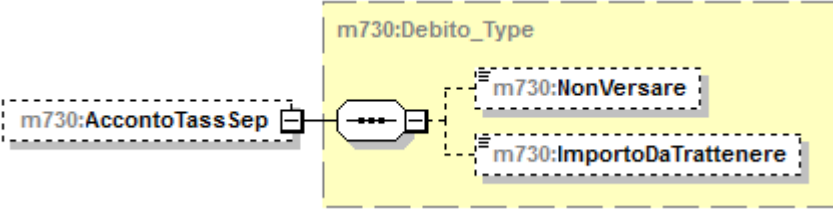
| | |
|-----------|--|
| diagram |  |
| namespace | urn:www.agenziaentrate.gov.it:specificheTecniche:sco:730 |
| type | m730:Debito_Type |
| children | m730:NonVersare m730:ImportoDaTrattenere |

element **Primo_Modulo_PL_Type/Prospetto/LiquidazioneImposte/AcontoAddComunale**

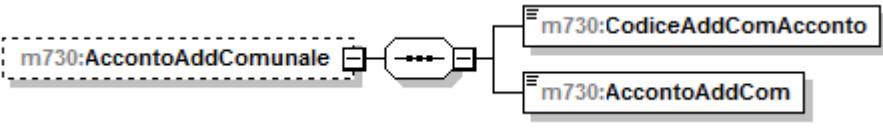
| | |
|-----------|--|
| diagram |  |
| namespace | urn:www.agenziaentrate.gov.it:specificheTecniche:sco:730 |
| children | m730:CodiceAddComAcconto m730:AccontoAddCom |

element **Primo_Modulo_PL_Type/Prospetto/LiquidazioneImposte/AcontoAddComunale/CodiceAddComAcconto**

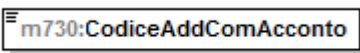
| | | |
|-----------|---|--|
| diagram |  | |
| namespace | urn:www.agenziaentrate.gov.it:specificheTecniche:sco:730 | |
| type | DatoAN_Type | |
| facets | Kind pattern | Value ([0-9A-Z\-\"]{1}){([0-9A-Z&:] ' \" \\. / ' \"\\(\\) À É È Ì Ò Ù Û " \\ \\ \\+)* |

element **Primo_Modulo_PL_Type/Prospetto/LiquidazioneImposte/AcontoAddComunale/AcontoAddCom**

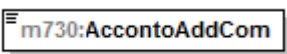
| | | |
|-----------|---|-------------------------|
| diagram |  | |
| namespace | urn:www.agenziaentrate.gov.it:specificheTecniche:sco:730 | |
| type | DatoNP_Type | |
| facets | Kind pattern | Value [1-9]{1}[0-9]* |

element **Primo_Modulo_PL_Type/Prospetto/LiquidazioneImposte/ImpSostProdut**

| | |
|-----------|---|
| diagram | <p>The diagram shows a dashed box labeled 'm730:ImpSostProdut' connected to a central node. This central node is connected to a larger dashed box labeled 'm730:Debito_Type'. Inside 'm730:Debito_Type', there are two sub-nodes: 'm730:NonVersare' and 'm730:ImportoDaTrattenere'.</p> |
| namespace | urn:www.agenziaentrate.gov.it:specificheTecniche:sco:730 |
| type | m730:Debito_Type |
| children | m730:NonVersare m730:ImportoDaTrattenere |

element **Primo_Modulo_PL_Type/Prospetto/LiquidazioneImposte/EsitoCedolareSecca**

| | |
|-----------|--|
| diagram | <p>The diagram shows a dashed box labeled 'm730:EsitoCedolareSecca' connected to a central node. This central node is connected to a larger dashed box labeled 'm730:Esito_Liquidazione_Type'. Inside 'm730:Esito_Liquidazione_Type', there are two sub-nodes: 'm730:Credito' and 'm730:Debito'.</p> |
| namespace | urn:www.agenziaentrate.gov.it:specificheTecniche:sco:730 |
| type | m730:Esito_Liquidazione_Type |
| children | m730:Credito m730:Debito |

element **Primo_Modulo_PL_Type/Prospetto/LiquidazioneImposte/PrimaRataAccCedolare**

| | | | | | |
|-----------|---|------|-------|---------|----------------|
| diagram | <p>The diagram shows a dashed box labeled 'm730:PrimaRataAccCedolare'.</p> | | | | |
| namespace | urn:www.agenziaentrate.gov.it:specificheTecniche:sco:730 | | | | |
| type | DatoNP_Type | | | | |
| facets | <table border="0"> <tr> <td>Kind</td> <td>Value</td> </tr> <tr> <td>pattern</td> <td>[1-9]{1}[0-9]*</td> </tr> </table> | Kind | Value | pattern | [1-9]{1}[0-9]* |
| Kind | Value | | | | |
| pattern | [1-9]{1}[0-9]* | | | | |

element **Primo_Modulo_PL_Type/Prospetto/LiquidazioneImposte/SecondaRataAccCedolare**

| | | | | | |
|-----------|---|------|-------|---------|----------------|
| diagram | <p>The diagram shows a dashed box labeled 'm730:SecondaRataAccCedolare'.</p> | | | | |
| namespace | urn:www.agenziaentrate.gov.it:specificheTecniche:sco:730 | | | | |
| type | DatoNP_Type | | | | |
| facets | <table border="0"> <tr> <td>Kind</td> <td>Value</td> </tr> <tr> <td>pattern</td> <td>[1-9]{1}[0-9]*</td> </tr> </table> | Kind | Value | pattern | [1-9]{1}[0-9]* |
| Kind | Value | | | | |
| pattern | [1-9]{1}[0-9]* | | | | |

element **Primo_Modulo_PL_Type/Prospetto/LiquidazioneImposte/ContribSolidarietaDebito**

| | |
|-----------|--|
| diagram | |
| namespace | urn:www.agenziaentrate.gov.it:specificheTecniche:sco:730 |
| type | m730:Debito_Type |
| children | m730:NonVersare m730:ImportoDaTrattenere |

element **Primo_Modulo_PL_Type/Prospetto/AltriDati**

| | |
|-----------|---|
| diagram | |
| namespace | urn:www.agenziaentrate.gov.it:specificheTecniche:sco:730 |
| type | m730:Altri_Dati_Type |
| children | m730:ResiduoCreditoErogazioneCultura m730:ResiduoCreditoPrimaCasa m730:ResiduoCreditoOccupazione m730:ResiduoCreditoSisma m730:ResiduoCreditoFondiPensione m730:ResiduoCreditoMediazioni m730:TotSpeseSanitarieRateizzate m730:RedditoAgevolazioniFiscali m730:RedditoComplessivoAcconto m730:RigoDifferenzaAcconto m730:RedditiFondiarNonImponibili m730:RedditoAbitazionePrincipalePertinenze |

| | |
|--|--|
| | m730:ResiduoDeduzioneSommeRestituite |
|--|--|

element **Primo_Modulo_PL_Type/Prospetto/CredImpEstero**

| | |
|-----------|---|
| diagram | |
| namespace | urn:www.agenziaentrate.gov.it:specificheTecniche:sco:730 |
| type | m730:Cred_Imp_Estero_Type |
| children | m730:Anno m730:TotCredito m730:CreditoStato |

element **Primo_Modulo_PL_Type/Prospetto/DatiCreditiF24**

| | |
|------------------|---|
| <p>diagram</p> | |
| <p>namespace</p> | <p>urn:www.agenziaentrate.gov.it:specificheTecniche:sco:730</p> |
| <p>type</p> | <p>m730:Crediti_F24_Type</p> |
| <p>children</p> | <p>m730:Credlrpef m730:CredlrpefDipNoSostituto m730:CodAddReg m730:CredAddReg m730:CredAddRegDipNoSostituto m730:CodiceAddCom m730:CredAddCom m730:CredAddComDipNoSostituto m730:CredCedolare m730:CredCedolareDipNoSostituto m730:CredTassSeparDipNoSostituto m730:CredProduttivitaDipNoSostituto m730:CredSolidarietaDipNoSostituto m730:Totale m730:TotaleDipNoSostituto</p> |

element **Primo_Modulo_PL_Type/ProspettoRideterminato**

| | |
|-----------|---|
| diagram | |
| namespace | urn:www.agenziaentrate.gov.it:specificheTecniche:sco:730 |
| type | extension of m730:Prospetto_Type |
| children | m730:RiepilogoRedditi m730:ImpostaLorda m730:DetrazioniCrediti m730:ImpostaNetta m730:RedditoAgevolazioniFiscali |

element **Primo_Modulo_PL_Type/ProspettoRideterminato/RedditoAgevolazioniFiscali**

| diagram | | | | | |
|-----------|---|------|-------|---------|----------------|
| namespace | urn:www.agenziaentrate.gov.it:specificheTecniche:sco:730 | | | | |
| type | DatoNP_Type | | | | |
| facets | <table border="1"> <thead> <tr> <th>Kind</th> <th>Value</th> </tr> </thead> <tbody> <tr> <td>pattern</td> <td>[1-9]{1}[0-9]*</td> </tr> </tbody> </table> | Kind | Value | pattern | [1-9]{1}[0-9]* |
| Kind | Value | | | | |
| pattern | [1-9]{1}[0-9]* | | | | |

complexType **PrimoModulo_Oneri_Type**

| | |
|------------------|---|
| <p>diagram</p> | |
| <p>namespace</p> | <p>urn:www.agenziaentrate.gov.it:specificheTecniche:sco:730</p> |
| <p>children</p> | <p>m730:SpeseDetrazioni m730:SpeseDeduzioni m730:InterventoRecuperoPatrimonioEdilizio m730:DatiCatastaliRecuperoPatrimonioEdilizio m730:InterventoRisparmioEnergetico m730:CanoniLocazione m730:DatiAltreDetrazioni m730:OneriNonAbbattuti m730:SpeseArredo</p> |

element **PrimoModulo_Oneri_Type/SpeseDetrazioni**

| | |
|------------------|--|
| <p>diagram</p> | |
| <p>namespace</p> | <p>urn:www.agenziaentrate.gov.it:specificheTecniche:sco:730</p> |
| <p>type</p> | <p>m730:Detrazioni_Type</p> |
| <p>children</p> | <p>m730:CasellaRateazione m730:SpeseDeterminatePatologie m730:SpeseSanitarie m730:SpeseFamNonACarico m730:SpeseSanitarieDisabili m730:VeicoliDisabili m730:AcquistoCaniGuida m730:SpeseRateizzate m730:MutuiAbPrincipale m730:AltreSpese</p> |

element **PrimoModulo_Oneri_Type/SpeseDeduzioni**

| | |
|------------------|---|
| <p>diagram</p> | <p>The diagram illustrates the structure of the <code>m730:SpeseDeduzioni</code> class. It is composed of several child classes, all of which are optional (indicated by a '+' sign in a square). The child classes are:</p> <ul style="list-style-type: none"> <code>m730:ContributiPrevAss</code> <code>m730:AssegnoConiuge</code> <code>m730:ContributiColf</code> <code>m730:ErogazioniIstituzioniReligi...</code> <code>m730:SpesePortatoriHandicap</code> <code>m730:AltriOneri</code> <code>m730:DeducibilitaOrdinaria</code> <code>m730:LavoratoriPrimaOccupazi...</code> <code>m730:FondiInSquilibrioFinanzia...</code> <code>m730:FamiliariACarico</code> <code>m730:FondoPensioneDipenden...</code> <code>m730:AcquistoCostruzioneAbit...</code> |
| <p>namespace</p> | <p>urn:www.agenziaentrate.gov.it:specificheTecniche:sco:730</p> |
| <p>type</p> | <p>m730:Deduzioni_Type</p> |
| <p>children</p> | <p>m730:ContributiPrevAss m730:AssegnoConiuge m730:ContributiColf m730:ErogazioniIstituzioniReligiose m730:SpesePortatoriHandicap m730:AltriOneri m730:DeducibilitaOrdinaria m730:LavoratoriPrimaOccupazione m730:FondiInSquilibrioFinanziario m730:FamiliariACarico m730:FondoPensioneDipendentiPubblici m730:AcquistoCostruzioneAbitLocazione</p> |

element **PrimoModulo_Oneri_Type/InterventoRecuperoPatrimonioEdilizio**

| | |
|------------------|---|
| <p>diagram</p> | |
| <p>namespace</p> | <p>urn:www.agenziaentrate.gov.it:specificheTecniche:sco:730</p> |
| <p>type</p> | <p>m730:Intervento Recupero Patrimonio Edilizio Type</p> |
| <p>children</p> | <p>m730:Anno m730:Periodo m730:CodiceFiscale m730:CasellaInterventiParticolari m730:CodiceSituazioniParticolari m730:AnnoSituazioniParticolari m730:RideterminazioneRate m730:NRate m730:Spesa m730:NOrdineImmobile</p> |

element **PrimoModulo_Oneri_Type/DatiCatastaliRecuperoPatrimonioEdilizio**

| | |
|------------------|--|
| <p>diagram</p> | |
| <p>namespace</p> | <p>urn:www.agenziaentrate.gov.it:specificheTecniche:sco:730</p> |
| <p>type</p> | <p>m730:Sezione Dati Catastali Recupero Patrimonio Edilizio Type</p> |
| <p>children</p> | <p>m730:DatiCatastaliRecuperoPatrimonioEdilizio m730:DatiRegistrazioneAccatastamentoRecuperoPatrimonio Edilizio</p> |

element **PrimoModulo_Oneri_Type/InterventoRisparmioEnergético**

| | |
|------------------|---|
| <p>diagram</p> | |
| <p>namespace</p> | <p>urn:www.agenziaentrate.gov.it:specificheTecniche:sco:730</p> |
| <p>type</p> | <p>m730:Intervento Risparmio Energetico Type</p> |
| <p>children</p> | <p>m730:TipoIntervento m730:Anno m730:Periodo2013 m730:CasiParticolari m730:RideterminazioneRate m730:RipartizioneRate m730:NumeroRata m730:Spesa</p> |

element **PrimoModulo_Oneri_Type/CanoniLocazione**

| | |
|------------------|---|
| <p>diagram</p> | |
| <p>namespace</p> | <p>urn:www.agenziaentrate.gov.it:specificheTecniche:sco:730</p> |
| <p>type</p> | <p>m730:Detrazioni Canoni Locazione Type</p> |
| <p>children</p> | <p>m730:InquiliniAbitazionePrincipale m730:DipendentiTrasferiti</p> |

element **PrimoModulo_Oneri_Type/DatiAltreDetrazioni**

| | |
|------------------|--|
| <p>diagram</p> | |
| <p>namespace</p> | <p>urn:www.agenziaentrate.gov.it:specificheTecniche:sco:730</p> |
| <p>type</p> | <p>m730:Dati_Altre_Detrazioni_Type</p> |
| <p>children</p> | <p>m730:SpeseCaniGuida m730:AffittoTerreniAgricoliGiovani m730:AltreDetrazioni</p> |

element **PrimoModulo_Oneri_Type/OneriNonAbbattuti**

| | |
|------------------|---|
| <p>diagram</p> | |
| <p>namespace</p> | <p>urn:www.agenziaentrate.gov.it:specificheTecniche:sco:730</p> |
| <p>type</p> | <p>m730:Oneri Non Abbattuti_Type</p> |
| <p>children</p> | <p>m730:DetrazSpeseAssPersonale m730:DetrazErogazBiennaleVenezia m730:DetrazErogazSpettacolo m730:DetrazErogazSettoreMusicale m730:DeduzContributiPaesiSviluppo m730:DeduzOnlus m730:DetrazOspedaleGalliera m730:PrevidenzaCompIDipPubblici m730:InteressiMutuiAgrari m730:ArtBonus</p> |

element **PrimoModulo_Oneri_Type/SpeseArredo**

| | |
|-----------|--|
| diagram | |
| namespace | urn:www.agenziaentrate.gov.it:specificheTecniche:sco:730 |
| type | m730:Spese_Arredo_Type |
| children | m730:NumeroRata m730:Importo |

complexType **Prospetto_Liquidazione_Type**

| | |
|-----------|--|
| diagram | |
| namespace | urn:www.agenziaentrate.gov.it:specificheTecniche:sco:730 |
| children | m730:PrimoModulo m730:Modulo |

element **Prospetto_Liquidazione_Type/PrimoModulo**

| | |
|-----------|--|
| diagram | |
| namespace | urn:www.agenziaentrate.gov.it:specificheTecniche:sco:730 |
| type | m730:Primo_Modulo_PL_Type |
| children | m730:Prospetto m730:ProspettoRideterminato |

element **Prospetto_Liquidazione_Type/Modulo**

| | |
|-----------|--|
| diagram | |
| namespace | urn:www.agenziaentrate.gov.it:specificheTecniche:sco:730 |
| type | m730:Modulo_PL_Type |

| | |
|----------|------------------------------------|
| children | m730:CredImpEstero |
|----------|------------------------------------|

complexType **Prospetto_Type**

| | |
|-----------|--|
| diagram | |
| namespace | urn:www.agenziaentrate.gov.it:specificheTecniche:sco:730 |
| children | m730:RiepilogoRedditi m730:ImpostaLorda m730:DetrazioniCrediti m730:ImpostaNetta |

element **Prospetto_Type/RiepilogoRedditi**

| | |
|-----------|---|
| diagram | |
| namespace | urn:www.agenziaentrate.gov.it:specificheTecniche:sco:730 |
| type | m730:Riepilogo_Redditi_Type |
| children | m730:Dominicali m730:Agrari m730:Fabbricati m730:LavDip m730:AltriRedditi m730:ImponibileCedolare m730:ImponibileCedolareOrdinario m730:ImponibileCedolareAgevolato m730:AbitazionePrincipalePertinenze |

element **Prospetto_Type/ImpostaLorda**

| | |
|------------------|--|
| <p>diagram</p> | <pre> classDiagram class m730ImpostaLorda class m730Imposta_Lorda_Type class m730RedditoComplessivo class m730DeduzioneAbitazPrincipale class m730OneriDeducibili class m730RedditoImponibile class m730CompensiAttSport class m730ImportoImpostaLorda m730ImpostaLorda "1" *-- "1" m730Imposta_Lorda_Type m730Imposta_Lorda_Type "1" *-- "1" m730RedditoComplessivo m730Imposta_Lorda_Type "1" *-- "1" m730DeduzioneAbitazPrincipale m730Imposta_Lorda_Type "1" *-- "1" m730OneriDeducibili m730Imposta_Lorda_Type "1" *-- "1" m730RedditoImponibile m730Imposta_Lorda_Type "1" *-- "1" m730CompensiAttSport m730Imposta_Lorda_Type "1" *-- "1" m730ImportoImpostaLorda </pre> |
| <p>namespace</p> | <p>urn:www.agenziaentrate.gov.it:specificheTecniche:sco:730</p> |
| <p>type</p> | <p>m730:Imposta_Lorda_Type</p> |
| <p>children</p> | <p>m730:RedditoComplessivo m730:DeduzioneAbitazPrincipale m730:OneriDeducibili m730:RedditoImponibile m730:CompensiAttSport m730:ImportoImpostaLorda</p> |

element **Prospetto_Type/DetrazioniCrediti**

| | |
|------------------|---|
| <p>diagram</p> | |
| <p>namespace</p> | <p>urn:www.agenziaentrate.gov.it:specificheTecniche:sco:730</p> |
| <p>type</p> | <p>m730:Detrazione_Crediti_Type</p> |
| <p>children</p> | <p>m730:DetrazioneConiuge m730:DetrazioneFigli m730:UlterioreDetrazioneFigli m730:DetrazioneFamiliari m730:DetrazioneLavDip m730:DetrazionePens m730:DetrazioneAltriRedditi m730:DetrazioneOneri m730:DetrazioneRistrutturazione m730:DetrazioniArredolmmobili m730:DetrazioneRisparmioEnergetico m730:DetrazioneLocEAgricoliGiovani m730:AltreDetrazioni m730:CreditoPrimaCasa m730:CreditoOccupazione m730:CreditoFondiPensione m730:CreditoMediazioni m730:TotaleDetrazioniCrediti</p> |

element **Prospetto_Type/ImpostaNetta**

| | |
|------------------|--|
| <p>diagram</p> | |
| <p>namespace</p> | <p>urn:www.agenziaentrate.gov.it:specificheTecniche:sco:730</p> |
| <p>type</p> | <p>m730:Imposta_Netta_Type</p> |
| <p>children</p> | <p>m730:ImportoImpostaNetta m730:CredAltriSisma m730:CredAbitazSisma m730:CredImpEstere m730:CredErogCultura m730:CredCanNonPerc m730:CredDetrazIncapienti m730:Ritenute m730:Differenza m730:EccedenzaIrpef m730:AccontiVersati m730:RestituzioneBonus m730:CredRimborsatiSost m730:BonusIrpefSpettante m730:BonusIrpefRiconosciuto m730:RestituzioneBonusIrpef</p> |

complexType **Redditi_Capitale_Type**

| | |
|-----------|--|
| diagram | |
| namespace | urn:www.agenziaentrate.gov.it:specificheTecniche:sco:730 |
| children | m730:Utili m730:AltriRedditiDiCapitale m730:LavoroAutonomo m730:RedditiDiversi m730:RedditiDiversiDetraz |

element **Redditi_Capitale_Type/Utili**

| | |
|-----------|--|
| diagram | |
| namespace | urn:www.agenziaentrate.gov.it:specificheTecniche:sco:730 |
| type | m730:Altri_Redditi_Utili_Type |
| children | m730:Tipo_Reddito m730:RedditiRitenute |

element **Redditi_Capitale_Type/AltriRedditiDiCapitale**

| | |
|-----------|---|
| diagram | |
| namespace | urn:www.agenziaentrate.gov.it:specificheTecniche:sco:730 |
| type | m730:Sezione_Altri_Redd_Type |
| children | m730:TipoReddito m730:RedditiRitenute |

element **Redditi_Capitale_Type/LavoroAutonomo**

| | |
|-----------|---|
| diagram | |
| namespace | urn:www.agenziaentrate.gov.it:specificheTecniche:sco:730 |
| type | m730:Altri_Redditi_Lavoro_Autonomo_Type |
| children | m730:TipoReddito m730:RedditiRitenute |

element **Redditi_Capitale_Type/RedditiDiversi**

| | |
|-----------|--|
| diagram | |
| namespace | urn:www.agenziaentrate.gov.it:specificheTecniche:sco:730 |
| type | m730:Altri_Redditi_Diversi_Type |
| children | m730:TipoReddito m730:RedditiRitenuteSpese |

element **Redditi_Capitale_Type/RedditiDiversiDetraz**

| | |
|-----------|---|
| diagram | |
| namespace | urn:www.agenziaentrate.gov.it:specificheTecniche:sco:730 |
| type | m730:Altri_Redditi_Diversi_Detr_Type |
| children | m730:Tipo_Reddito m730:RedditiRitenuteSpese |

complexType **Redditi_Eredi_Legatari_Type**

| | |
|-----------|--|
| diagram | |
| namespace | urn:www.agenziaentrate.gov.it:specificheTecniche:sco:730 |
| type | extension of m730:Tassazione_Separata_Type |
| children | m730:Opzione m730:Anno m730:RedditoRitenute m730:TipoReddito m730:RedditoTotale m730:QuotaImposteSuccessioni |

element **Redditi_Eredi_Legatari_Type/TipoReddito**

| diagram | | | | | | | | | | | | | | | | | | | | | | | | | | | | | |
|-------------|--|------|-------|---------|----------------|-------------|---|-------------|---|-------------|---|-------------|---|-------------|---|-------------|---|-------------|---|-------------|---|-------------|---|-------------|----|-------------|----|-------------|----|
| namespace | urn:www.agenziaentrate.gov.it:specificheTecniche:sco:730 | | | | | | | | | | | | | | | | | | | | | | | | | | | | |
| type | m730:Tipo_Reddito_Da1a12_Type | | | | | | | | | | | | | | | | | | | | | | | | | | | | |
| facets | <table border="1"> <thead> <tr> <th>Kind</th> <th>Value</th> </tr> </thead> <tbody> <tr> <td>pattern</td> <td>[1-9]{1}[0-9]*</td> </tr> <tr> <td>enumeration</td> <td>1</td> </tr> <tr> <td>enumeration</td> <td>2</td> </tr> <tr> <td>enumeration</td> <td>3</td> </tr> <tr> <td>enumeration</td> <td>4</td> </tr> <tr> <td>enumeration</td> <td>5</td> </tr> <tr> <td>enumeration</td> <td>6</td> </tr> <tr> <td>enumeration</td> <td>7</td> </tr> <tr> <td>enumeration</td> <td>8</td> </tr> <tr> <td>enumeration</td> <td>9</td> </tr> <tr> <td>enumeration</td> <td>10</td> </tr> <tr> <td>enumeration</td> <td>11</td> </tr> <tr> <td>enumeration</td> <td>12</td> </tr> </tbody> </table> | Kind | Value | pattern | [1-9]{1}[0-9]* | enumeration | 1 | enumeration | 2 | enumeration | 3 | enumeration | 4 | enumeration | 5 | enumeration | 6 | enumeration | 7 | enumeration | 8 | enumeration | 9 | enumeration | 10 | enumeration | 11 | enumeration | 12 |
| Kind | Value | | | | | | | | | | | | | | | | | | | | | | | | | | | | |
| pattern | [1-9]{1}[0-9]* | | | | | | | | | | | | | | | | | | | | | | | | | | | | |
| enumeration | 1 | | | | | | | | | | | | | | | | | | | | | | | | | | | | |
| enumeration | 2 | | | | | | | | | | | | | | | | | | | | | | | | | | | | |
| enumeration | 3 | | | | | | | | | | | | | | | | | | | | | | | | | | | | |
| enumeration | 4 | | | | | | | | | | | | | | | | | | | | | | | | | | | | |
| enumeration | 5 | | | | | | | | | | | | | | | | | | | | | | | | | | | | |
| enumeration | 6 | | | | | | | | | | | | | | | | | | | | | | | | | | | | |
| enumeration | 7 | | | | | | | | | | | | | | | | | | | | | | | | | | | | |
| enumeration | 8 | | | | | | | | | | | | | | | | | | | | | | | | | | | | |
| enumeration | 9 | | | | | | | | | | | | | | | | | | | | | | | | | | | | |
| enumeration | 10 | | | | | | | | | | | | | | | | | | | | | | | | | | | | |
| enumeration | 11 | | | | | | | | | | | | | | | | | | | | | | | | | | | | |
| enumeration | 12 | | | | | | | | | | | | | | | | | | | | | | | | | | | | |

element **Redditi_Eredi_Legatari_Type/RedditoTotale**

| diagram | | | | | |
|-----------|---|------|-------|---------|----------------|
| namespace | urn:www.agenziaentrate.gov.it:specificheTecniche:sco:730 | | | | |
| type | DatoNP_Type | | | | |
| facets | <table border="1"> <thead> <tr> <th>Kind</th> <th>Value</th> </tr> </thead> <tbody> <tr> <td>pattern</td> <td>[1-9]{1}[0-9]*</td> </tr> </tbody> </table> | Kind | Value | pattern | [1-9]{1}[0-9]* |
| Kind | Value | | | | |
| pattern | [1-9]{1}[0-9]* | | | | |

element Redditi_Eredi_Legatari_Type/QuotalmposteSuccessioni

| | |
|-----------|--|
| diagram | |
| namespace | urn:www.agenziaentrate.gov.it:specificheTecniche:sco:730 |
| type | DatoNP_Type |
| facets | Kind Value pattern [1-9]{1}[0-9]* |

complexType Redditi_Fabbricati_Type

| | |
|-----------|--|
| diagram | |
| namespace | urn:www.agenziaentrate.gov.it:specificheTecniche:sco:730 |
| children | m730:Modulo |

element Redditi_Fabbricati_Type/Modulo

| | |
|-----------|--|
| diagram | |
| namespace | urn:www.agenziaentrate.gov.it:specificheTecniche:sco:730 |
| type | m730:Modulo_Fabbricato_Type |
| children | m730:FabbricatoOrd m730:FabbricatoAgev |

complexType Redditi_Lavoro_Dip_Type

| | |
|-----------|--|
| diagram | |
| namespace | urn:www.agenziaentrate.gov.it:specificheTecniche:sco:730 |
| children | m730:PrimoModulo m730:Modulo |

element **Redditi_Lavoro_Dip_Type/PrimoModulo**

| | |
|------------------|---|
| <p>diagram</p> | |
| <p>namespace</p> | <p>urn:www.agenziaentrate.gov.it:specificheTecniche:sco:730</p> |
| <p>type</p> | <p>m730:Primo Modulo Lavoro Dip Type</p> |
| <p>children</p> | <p>m730:LavoroDipendente m730:IncrementoProduttivita m730:PeriodoLavoro m730:AltriRedditiAssLavDip m730:RitenuteLavoroDipendente m730:BonusIrpef m730:RedditoAlNettoContribPensioni m730:ContribSolidarietaTrattenuto m730:CasellaCasiParticolari</p> |

element **Redditi_Lavoro_Dip_Type/Modulo**

| | |
|------------------|---|
| <p>diagram</p> | |
| <p>namespace</p> | <p>urn:www.agenziaentrate.gov.it:specificheTecniche:sco:730</p> |
| <p>type</p> | <p>m730:Modulo Lavoro Dip Type</p> |
| <p>children</p> | <p>m730:LavoroDipendente m730:AltriRedditiAssLavDip</p> |

complexType Redditi_Ritenute_Spese_Type

| | |
|-----------|--|
| diagram | |
| namespace | urn:www.agenziaentrate.gov.it:specificheTecniche:sco:730 |
| type | extension of m730:Redditi_Ritenute_Type |
| children | m730:ImportoRedditi m730:ImportoRitenute m730:ImportoSpese |

element Redditi_Ritenute_Spese_Type/ImportoSpese

| diagram | | | | | |
|-----------|---|------|-------|---------|----------------|
| namespace | urn:www.agenziaentrate.gov.it:specificheTecniche:sco:730 | | | | |
| type | DatoNP_Type | | | | |
| facets | <table border="1"> <tr> <th>Kind</th> <th>Value</th> </tr> <tr> <td>pattern</td> <td>[1-9]{1}[0-9]*</td> </tr> </table> | Kind | Value | pattern | [1-9]{1}[0-9]* |
| Kind | Value | | | | |
| pattern | [1-9]{1}[0-9]* | | | | |

complexType Redditi_Ritenute_Type

| | |
|-----------|--|
| diagram | |
| namespace | urn:www.agenziaentrate.gov.it:specificheTecniche:sco:730 |
| children | m730:ImportoRedditi m730:ImportoRitenute |

element Redditi_Ritenute_Type/ImportoRedditi

| diagram | | | | | |
|-----------|---|------|-------|---------|----------------|
| namespace | urn:www.agenziaentrate.gov.it:specificheTecniche:sco:730 | | | | |
| type | DatoNP_Type | | | | |
| facets | <table border="1"> <tr> <th>Kind</th> <th>Value</th> </tr> <tr> <td>pattern</td> <td>[1-9]{1}[0-9]*</td> </tr> </table> | Kind | Value | pattern | [1-9]{1}[0-9]* |
| Kind | Value | | | | |
| pattern | [1-9]{1}[0-9]* | | | | |

element **Redditi_Ritenute_Type/ImportoRitenute**

| | |
|-----------|---|
| diagram |  |
| namespace | urn:www.agenziaentrate.gov.it:specificheTecniche:sco:730 |
| type | DatoNP_Type |
| facets | Kind Value pattern [1-9]{1}[0-9]* |

complexType **Redditi_Tassazione_Separata_Type**

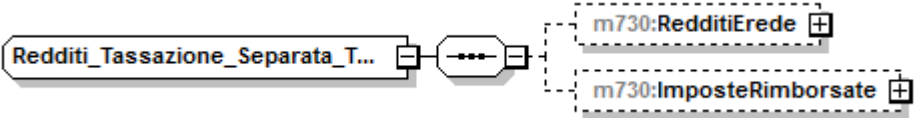
| | |
|-----------|--|
| diagram |  |
| namespace | urn:www.agenziaentrate.gov.it:specificheTecniche:sco:730 |
| children | m730:RedditiErede m730:ImposteRimborsate |

element **Redditi_Tassazione_Separata_Type/RedditiErede**

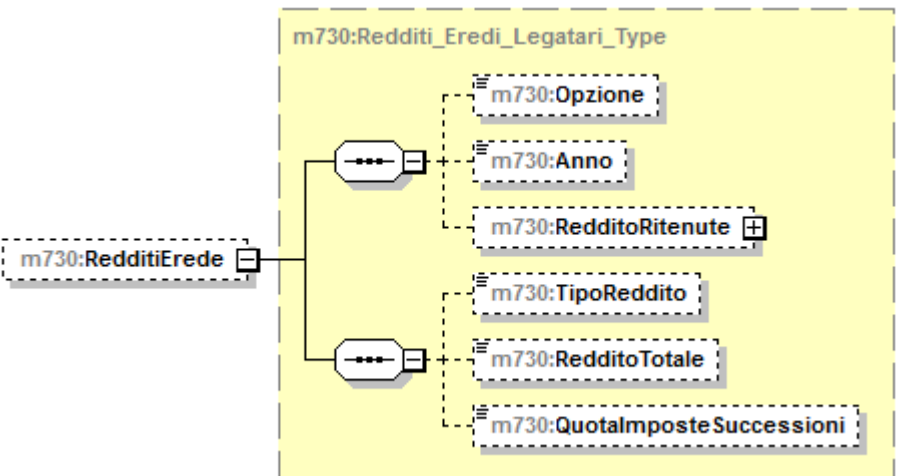
| | |
|-----------|--|
| diagram |  |
| namespace | urn:www.agenziaentrate.gov.it:specificheTecniche:sco:730 |
| type | m730:Redditi_Eredi_Legatari_Type |
| children | m730:Opzione m730:Anno m730:RedditoRitenute m730:TipoReddito m730:RedditoTotale m730:QuotaImposteSuccessioni |

element **Redditi_Tassazione_Separata_Type/ImposteRimborsate**

| | |
|-----------|--|
| diagram | |
| namespace | urn:www.agenziaentrate.gov.it:specificheTecniche:sco:730 |
| type | m730:Imposte Rimborsate Type |
| children | m730:TipoReddito m730:TassazioneSeparata |

complexType **Redditi_Terreni_Type**

| | |
|-----------|--|
| diagram | |
| namespace | urn:www.agenziaentrate.gov.it:specificheTecniche:sco:730 |
| children | m730:Modulo |

element **Redditi_Terreni_Type/Modulo**

| | |
|-----------|--|
| diagram | |
| namespace | urn:www.agenziaentrate.gov.it:specificheTecniche:sco:730 |
| type | m730:Modulo Terreno Type |
| children | m730:Terreno |

complexType **Reddito_Erede_Type**

| | |
|-----------|--|
| diagram | |
| namespace | urn:www.agenziaentrate.gov.it:specificheTecniche:sco:730 |
| type | extension of m730:Tassazione Separata Type |

| | |
|----------|---|
| children | m730:Opzione m730:Anno m730:RedditoRitenute |
|----------|---|

complexType Residuo_Credito_Compens_AnnoImposta_Type

| | |
|-----------|--|
| diagram | |
| namespace | urn:www.agenziaentrate.gov.it:specificheTecniche:sco:730 |
| type | extension of m730:Residuo_Credito_Compens_Type |
| children | m730:CreditoAnno m730:DiCuiCompensatoF24 |

complexType Residuo_Credito_Compens_Type

| | |
|-----------|--|
| diagram | |
| namespace | urn:www.agenziaentrate.gov.it:specificheTecniche:sco:730 |
| children | m730:CreditoAnno m730:DiCuiCompensatoF24 |

element Residuo_Credito_Compens_Type/CreditoAnno

| | | | | | |
|-----------|---|------|-------|---------|----------------|
| diagram | | | | | |
| namespace | urn:www.agenziaentrate.gov.it:specificheTecniche:sco:730 | | | | |
| type | DatoNP_Type | | | | |
| facets | <table border="1"> <tr> <td>Kind</td> <td>Value</td> </tr> <tr> <td>pattern</td> <td>[1-9]{1}[0-9]*</td> </tr> </table> | Kind | Value | pattern | [1-9]{1}[0-9]* |
| Kind | Value | | | | |
| pattern | [1-9]{1}[0-9]* | | | | |

element Residuo_Credito_Compens_Type/DiCuiCompensatoF24

| | | | | | |
|-----------|---|------|-------|---------|----------------|
| diagram | | | | | |
| namespace | urn:www.agenziaentrate.gov.it:specificheTecniche:sco:730 | | | | |
| type | DatoNP_Type | | | | |
| facets | <table border="1"> <tr> <td>Kind</td> <td>Value</td> </tr> <tr> <td>pattern</td> <td>[1-9]{1}[0-9]*</td> </tr> </table> | Kind | Value | pattern | [1-9]{1}[0-9]* |
| Kind | Value | | | | |
| pattern | [1-9]{1}[0-9]* | | | | |

complexType **Riepilogo_Redditi_Type**

| | |
|-----------|---|
| diagram | |
| namespace | urn:www.agenziaentrate.gov.it:specificheTecniche:sco:730 |
| children | m730:Dominicali m730:Agrari m730:Fabbricati m730:LavDip m730:AltriRedditi m730:ImponibileCedolare m730:ImponibileCedolareOrdinario m730:ImponibileCedolareAgevolato m730:AbitazionePrincipalePertinenze |

element **Riepilogo_Redditi_Type/Dominicali**

| | | | | | |
|-----------|---|------|-------|---------|----------------|
| diagram | | | | | |
| namespace | urn:www.agenziaentrate.gov.it:specificheTecniche:sco:730 | | | | |
| type | DatoNP_Type | | | | |
| facets | <table border="1"> <tr> <td>Kind</td> <td>Value</td> </tr> <tr> <td>pattern</td> <td>[1-9]{1}[0-9]*</td> </tr> </table> | Kind | Value | pattern | [1-9]{1}[0-9]* |
| Kind | Value | | | | |
| pattern | [1-9]{1}[0-9]* | | | | |

element **Riepilogo_Redditi_Type/Agrari**

| | | | | | |
|-----------|---|------|-------|---------|----------------|
| diagram | | | | | |
| namespace | urn:www.agenziaentrate.gov.it:specificheTecniche:sco:730 | | | | |
| type | DatoNP_Type | | | | |
| facets | <table border="1"> <tr> <td>Kind</td> <td>Value</td> </tr> <tr> <td>pattern</td> <td>[1-9]{1}[0-9]*</td> </tr> </table> | Kind | Value | pattern | [1-9]{1}[0-9]* |
| Kind | Value | | | | |
| pattern | [1-9]{1}[0-9]* | | | | |

element **Riepilogo_Redditi_Type/Fabbricati**

| | |
|-----------|--|
| diagram | |
| namespace | urn:www.agenziaentrate.gov.it:specificheTecniche:sco:730 |

| | |
|--------|--------------------------------------|
| type | DatoNP_Type |
| facets | Kind Value pattern [1-9]{1}[0-9]* |

element Riepilogo_Reddito_Type/LavDip

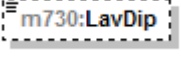
| | |
|-----------|---|
| diagram |  |
| namespace | urn:www.agenziaentrate.gov.it:specificheTecniche:sco:730 |
| type | DatoNP_Type |
| facets | Kind Value pattern [1-9]{1}[0-9]* |

element Riepilogo_Reddito_Type/AltriRedditi

| | |
|-----------|---|
| diagram |  |
| namespace | urn:www.agenziaentrate.gov.it:specificheTecniche:sco:730 |
| type | DatoNP_Type |
| facets | Kind Value pattern [1-9]{1}[0-9]* |

element Riepilogo_Reddito_Type/ImponibileCedolare

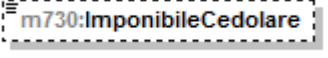
| | |
|-----------|---|
| diagram |  |
| namespace | urn:www.agenziaentrate.gov.it:specificheTecniche:sco:730 |
| type | DatoNP_Type |
| facets | Kind Value pattern [1-9]{1}[0-9]* |

element Riepilogo_Reddito_Type/ImponibileCedolareOrdinario

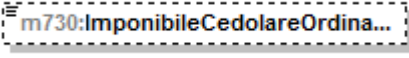
| | |
|-----------|---|
| diagram |  |
| namespace | urn:www.agenziaentrate.gov.it:specificheTecniche:sco:730 |
| type | DatoNP_Type |
| facets | Kind Value pattern [1-9]{1}[0-9]* |

element Riepilogo_Reddito_Type/ImponibileCedolareAgevolato

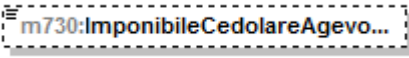
| | |
|-----------|---|
| diagram |  |
| namespace | urn:www.agenziaentrate.gov.it:specificheTecniche:sco:730 |

| | |
|--------|--------------------------------------|
| type | DatoNP_Type |
| facets | Kind Value pattern [1-9]{1}[0-9]* |

element **Riepilogo_Reddito_Type/AbitazionePrincipalePertinenze**

| | |
|-----------|--|
| diagram | |
| namespace | urn:www.agenziaentrate.gov.it:specificheTecniche:sco:730 |
| type | DatoNP_Type |
| facets | Kind Value pattern [1-9]{1}[0-9]* |

complexType **Ritenute_Acconti_Sospesi_Type**

| | |
|-----------|---|
| diagram | |
| namespace | urn:www.agenziaentrate.gov.it:specificheTecniche:sco:730 |
| children | m730:CodiceEvento m730:lrpef m730:AddRegionalelrpef m730:AddComunalelrpef m730:SostitutivaProduttivita m730:CedolareSecca m730:ContribSolidarieta |

element **Ritenute_Acconti_Sospesi_Type/CodiceEvento**

| | |
|-----------|---|
| diagram | |
| namespace | urn:www.agenziaentrate.gov.it:specificheTecniche:sco:730 |
| type | m730:Codice_Evento_Eccezionale_Type |
| facets | Kind Value pattern [1-9] enumeration 1 enumeration 2 enumeration 3 enumeration 4 enumeration 5 enumeration 6 enumeration 7 enumeration 8 |

element **Ritenute_Acconti_Sospesi_Type/Irpef**

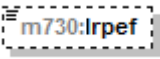
| | |
|-----------|---|
| diagram |  |
| namespace | urn:www.agenziaentrate.gov.it:specificheTecniche:sco:730 |
| type | DatoNP_Type |
| facets | Kind Value pattern [1-9]{1}[0-9]* |

element **Ritenute_Acconti_Sospesi_Type/AddRegionaleIrpef**

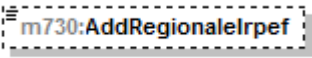
| | |
|-----------|---|
| diagram |  |
| namespace | urn:www.agenziaentrate.gov.it:specificheTecniche:sco:730 |
| type | DatoNP_Type |
| facets | Kind Value pattern [1-9]{1}[0-9]* |

element **Ritenute_Acconti_Sospesi_Type/AddComunaleIrpef**

| | |
|-----------|--|
| diagram |  |
| namespace | urn:www.agenziaentrate.gov.it:specificheTecniche:sco:730 |
| type | DatoNP_Type |
| facets | Kind Value pattern [1-9]{1}[0-9]* |

element **Ritenute_Acconti_Sospesi_Type/SostitutivaProduttivita**

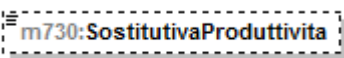
| | |
|-----------|---|
| diagram |  |
| namespace | urn:www.agenziaentrate.gov.it:specificheTecniche:sco:730 |
| type | DatoNP_Type |
| facets | Kind Value pattern [1-9]{1}[0-9]* |

element **Ritenute_Acconti_Sospesi_Type/CedolareSecca**

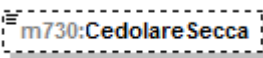
| | |
|-----------|---|
| diagram |  |
| namespace | urn:www.agenziaentrate.gov.it:specificheTecniche:sco:730 |
| type | DatoNP_Type |
| facets | Kind Value pattern [1-9]{1}[0-9]* |

element Ritenute_Acconti_Sospesi_Type/ContribSolidarieta

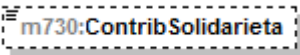
| | |
|-----------|---|
| diagram |  |
| namespace | urn:www.agenziaentrate.gov.it:specificheTecniche:sco:730 |
| type | DatoNP_Type |
| facets | Kind Value pattern [1-9]{1}[0-9]* |

complexType Ritenute_Lavoro_Dip_Type

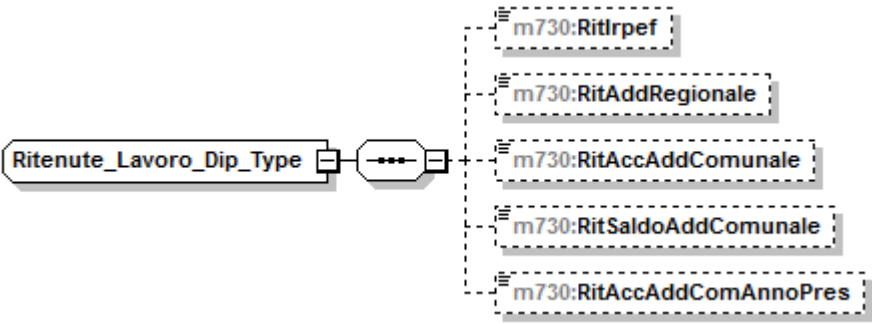
| | |
|-----------|--|
| diagram |  |
| namespace | urn:www.agenziaentrate.gov.it:specificheTecniche:sco:730 |
| children | m730:Ritlrpef m730:RitAddRegionale m730:RitAccAddComunale m730:RitSaldoAddComunale m730:RitAccAddComAnnoPres |

element Ritenute_Lavoro_Dip_Type/Ritlrpef

| | |
|-----------|---|
| diagram |  |
| namespace | urn:www.agenziaentrate.gov.it:specificheTecniche:sco:730 |
| type | DatoNP_Type |
| facets | Kind Value pattern [1-9]{1}[0-9]* |

element Ritenute_Lavoro_Dip_Type/RitAddRegionale

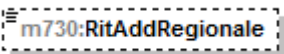
| | |
|-----------|---|
| diagram |  |
| namespace | urn:www.agenziaentrate.gov.it:specificheTecniche:sco:730 |
| type | DatoNP_Type |
| facets | Kind Value pattern [1-9]{1}[0-9]* |

element Ritenute_Lavoro_Dip_Type/RitAccAddComunale

| | | | | | |
|-----------|---|------|-------|---------|----------------|
| diagram | | | | | |
| namespace | urn:www.agenziaentrate.gov.it:specificheTecniche:sco:730 | | | | |
| type | DatoNP_Type | | | | |
| facets | <table border="1"> <tr> <td>Kind</td> <td>Value</td> </tr> <tr> <td>pattern</td> <td>[1-9]{1}[0-9]*</td> </tr> </table> | Kind | Value | pattern | [1-9]{1}[0-9]* |
| Kind | Value | | | | |
| pattern | [1-9]{1}[0-9]* | | | | |

element Ritenute_Lavoro_Dip_Type/RitSaldoAddComunale

| | | | | | |
|-----------|---|------|-------|---------|----------------|
| diagram | | | | | |
| namespace | urn:www.agenziaentrate.gov.it:specificheTecniche:sco:730 | | | | |
| type | DatoNP_Type | | | | |
| facets | <table border="1"> <tr> <td>Kind</td> <td>Value</td> </tr> <tr> <td>pattern</td> <td>[1-9]{1}[0-9]*</td> </tr> </table> | Kind | Value | pattern | [1-9]{1}[0-9]* |
| Kind | Value | | | | |
| pattern | [1-9]{1}[0-9]* | | | | |

element Ritenute_Lavoro_Dip_Type/RitAccAddComAnnoPres

| | | | | | |
|-----------|---|------|-------|---------|----------------|
| diagram | | | | | |
| namespace | urn:www.agenziaentrate.gov.it:specificheTecniche:sco:730 | | | | |
| type | DatoNP_Type | | | | |
| facets | <table border="1"> <tr> <td>Kind</td> <td>Value</td> </tr> <tr> <td>pattern</td> <td>[1-9]{1}[0-9]*</td> </tr> </table> | Kind | Value | pattern | [1-9]{1}[0-9]* |
| Kind | Value | | | | |
| pattern | [1-9]{1}[0-9]* | | | | |

complexType Sezione_Altri_Redd_Type

| | |
|-----------|---|
| diagram | |
| namespace | urn:www.agenziaentrate.gov.it:specificheTecniche:sco:730 |
| children | m730:TipoReddito m730:RedditiRitenute |

element Sezione_Altri_Redd_Type/TipoReddito

| | | | | | | | | | |
|-------------|---|------|-------|---------|----------------|-------------|---|-------------|---|
| diagram | | | | | | | | | |
| namespace | urn:www.agenziaentrate.gov.it:specificheTecniche:sco:730 | | | | | | | | |
| type | m730:Tipo_Reddito_Da1a8_Type | | | | | | | | |
| facets | <table border="1"> <tr> <td>Kind</td> <td>Value</td> </tr> <tr> <td>pattern</td> <td>[1-9]{1}[0-9]*</td> </tr> <tr> <td>enumeration</td> <td>1</td> </tr> <tr> <td>enumeration</td> <td>2</td> </tr> </table> | Kind | Value | pattern | [1-9]{1}[0-9]* | enumeration | 1 | enumeration | 2 |
| Kind | Value | | | | | | | | |
| pattern | [1-9]{1}[0-9]* | | | | | | | | |
| enumeration | 1 | | | | | | | | |
| enumeration | 2 | | | | | | | | |

| | |
|--|---------------|
| | enumeration 3 |
| | enumeration 4 |
| | enumeration 5 |
| | enumeration 6 |
| | enumeration 7 |
| | enumeration 8 |

element **Sezione_Altri_Reddi_Type/RedditiRitenute**

| | |
|-----------|--|
| diagram | |
| namespace | urn:www.agenziaentrate.gov.it:specificheTecniche:sco:730 |
| type | m730:Redditi_Ritenute_Type |
| children | m730:ImportoRedditi m730:ImportoRitenute |

complexType **Sezione_Dati_Catastali_Recupero_Patrimonio_Edilizio_Type**

| | |
|-----------|---|
| diagram | |
| namespace | urn:www.agenziaentrate.gov.it:specificheTecniche:sco:730 |
| children | m730:DatiCatastaliRecuperoPatrimonioEdilizio m730:DatiRegistrazioneAccatastamentoRecuperoPatrimonio_Edilizio |

element

Sezione Dati Catastali Recupero Patrimonio Edilizio Type/DatiCatastaliRecuperoPatrimonioEdilizio

| | |
|------------------|--|
| <p>diagram</p> | |
| <p>namespace</p> | <p>urn:www.agenziaentrate.gov.it:specificheTecniche:sco:730</p> |
| <p>type</p> | <p>extension of m730:Dati Catastali Recupero Patrimonio Edilizio Type</p> |
| <p>children</p> | <p>m730:NOrdImmobile m730:Condominio m730:CodiceComune m730:TerreniUrbano m730:SezioneUrbanaComuneCatastale m730:Foglio m730:Particella m730:Subalterno</p> |

element

Sezione Dati Catastali Recupero Patrimonio Edilizio Type/DatiRegistrazioneAccatastamentoRecuperoPatrimonio Edilizio

| | |
|------------------|---|
| <p>diagram</p> | |
| <p>namespace</p> | <p>urn:www.agenziaentrate.gov.it:specificheTecniche:sco:730</p> |
| <p>type</p> | <p>m730:Dati Registrazione Accatastamento Recupero Patrimonio Edilizio Type</p> |
| <p>children</p> | <p>m730:NOrdImmobile m730:Condominio m730:EstremiRegistrazioneContratto m730:DataDomandaAccatastamento m730:NumeroDomandaAccatastamento m730:ProvinciaUfficioDomandaAccatastamento</p> |

complexType **Soggetto_Fiscale_730_Type**

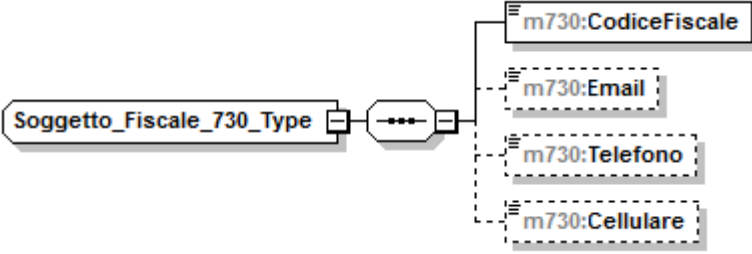
| | |
|-----------|--|
| diagram |  |
| namespace | urn:www.agenziaentrate.gov.it:specificheTecniche:sco:730 |
| children | m730:CodiceFiscale m730:Email m730:Telefono m730:Cellulare |

element **Soggetto_Fiscale_730_Type/CodiceFiscale**

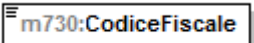
| diagram |  | | | | |
|-----------|---|------|-------|---------|--|
| namespace | urn:www.agenziaentrate.gov.it:specificheTecniche:sco:730 | | | | |
| type | DatoCF_Type | | | | |
| facets | <table border="1"> <thead> <tr> <th>Kind</th> <th>Value</th> </tr> </thead> <tbody> <tr> <td>pattern</td> <td>[0-9]{11}[A-Z]{6}[0-9LMNPQRSTUUV]{2}[A-Z]{1}[0-9LMNPQRSTUUV]{2}[A-Z]{1}[0-9LMNPQRSTUUV]{3}[A-Z]{1}</td> </tr> </tbody> </table> | Kind | Value | pattern | [0-9]{11}[A-Z]{6}[0-9LMNPQRSTUUV]{2}[A-Z]{1}[0-9LMNPQRSTUUV]{2}[A-Z]{1}[0-9LMNPQRSTUUV]{3}[A-Z]{1} |
| Kind | Value | | | | |
| pattern | [0-9]{11}[A-Z]{6}[0-9LMNPQRSTUUV]{2}[A-Z]{1}[0-9LMNPQRSTUUV]{2}[A-Z]{1}[0-9LMNPQRSTUUV]{3}[A-Z]{1} | | | | |

element **Soggetto_Fiscale_730_Type/Email**

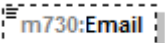
| diagram |  | | | | |
|-----------|--|------|-------|---------|---|
| namespace | urn:www.agenziaentrate.gov.it:specificheTecniche:sco:730 | | | | |
| type | DatoEM_Type | | | | |
| facets | <table border="1"> <thead> <tr> <th>Kind</th> <th>Value</th> </tr> </thead> <tbody> <tr> <td>pattern</td> <td>[a-zA-Z0-9._%'\-'\&quot;?^~=]+@[a-zA-Z0-9.\-]+\.[a-zA-Z]{2,4}</td> </tr> </tbody> </table> | Kind | Value | pattern | [a-zA-Z0-9._%'\-'\"?^~=]+@[a-zA-Z0-9.\-]+\.[a-zA-Z]{2,4} |
| Kind | Value | | | | |
| pattern | [a-zA-Z0-9._%'\-'\"?^~=]+@[a-zA-Z0-9.\-]+\.[a-zA-Z]{2,4} | | | | |

element **Soggetto_Fiscale_730_Type/Telefono**

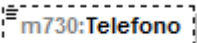
| diagram |  | | | | |
|-----------|--|------|-------|---------|---|
| namespace | urn:www.agenziaentrate.gov.it:specificheTecniche:sco:730 | | | | |
| type | DatoAN_Type | | | | |
| facets | <table border="1"> <thead> <tr> <th>Kind</th> <th>Value</th> </tr> </thead> <tbody> <tr> <td>pattern</td> <td>(([0-9A-Z-] \&quot;){1}([0-9A-Z&amp;:] \- \., / \^\(\ \)\ À É Ì Ò Ù Û \&quot; \ \\ / +)*</td> </tr> </tbody> </table> | Kind | Value | pattern | (([0-9A-Z-] \"){1}([0-9A-Z&:] \- \., / \^\(\ \)\ À É Ì Ò Ù Û \" \ \\ / +)* |
| Kind | Value | | | | |
| pattern | (([0-9A-Z-] \"){1}([0-9A-Z&:] \- \., / \^\(\ \)\ À É Ì Ò Ù Û \" \ \\ / +)* | | | | |

element **Soggetto_Fiscale_730_Type/Cellulare**

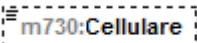
| | |
|-----------|---|
| diagram |  |
| namespace | urn:www.agenziaentrate.gov.it:specificheTecniche:sco:730 |

| | |
|--------|---|
| type | DatoAN_Type |
| facets | Kind Value pattern ([0-9A-Z\-_]"){1}([0-9A-Z&:] ' - \., / ° '\'\'(\)\ À È É Ì Ò Ù Û " \ \\ /+)* |

complexType **Soglie_Esenzione_Type**

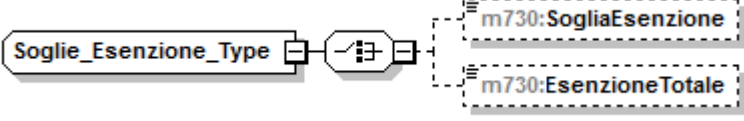
| | |
|-----------|--|
| diagram |  |
| namespace | urn:www.agenziaentrate.gov.it:specificheTecniche:sco:730 |
| children | m730:SogliaEsenzione m730:EsenzioneTotale |

element **Soglie_Esenzione_Type/SogliaEsenzione**

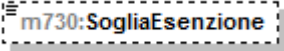
| | |
|-----------|---|
| diagram |  |
| namespace | urn:www.agenziaentrate.gov.it:specificheTecniche:sco:730 |
| type | DatoNP_Type |
| facets | Kind Value pattern [1-9]{1}[0-9]* |

element **Soglie_Esenzione_Type/EsenzioneTotale**

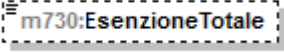
| | |
|-----------|---|
| diagram |  |
| namespace | urn:www.agenziaentrate.gov.it:specificheTecniche:sco:730 |
| type | restriction of DatoN1_Type |
| facets | Kind Value pattern [1-9] enumeration 1 enumeration 2 |

complexType **Spese_Arredo_Type**

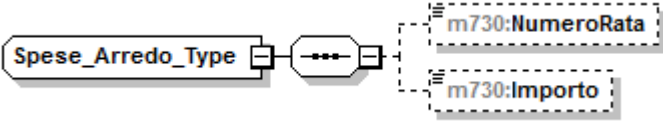
| | |
|-----------|---|
| diagram |  |
| namespace | urn:www.agenziaentrate.gov.it:specificheTecniche:sco:730 |
| children | m730:NumeroRata m730:Importo |

element **Spese_Arredo_Type/NumeroRata**

| diagram | | | | | | | | | |
|-------------|--|------|-------|---------|-------|-------------|---|-------------|---|
| namespace | urn:www.agenziaentrate.gov.it:specificheTecniche:sco:730 | | | | | | | | |
| type | m730:Numero_RateDa1A2_Type | | | | | | | | |
| facets | <table border="1"> <thead> <tr> <th>Kind</th> <th>Value</th> </tr> </thead> <tbody> <tr> <td>pattern</td> <td>[1-9]</td> </tr> <tr> <td>enumeration</td> <td>1</td> </tr> <tr> <td>enumeration</td> <td>2</td> </tr> </tbody> </table> | Kind | Value | pattern | [1-9] | enumeration | 1 | enumeration | 2 |
| Kind | Value | | | | | | | | |
| pattern | [1-9] | | | | | | | | |
| enumeration | 1 | | | | | | | | |
| enumeration | 2 | | | | | | | | |

element **Spese_Arredo_Type/Importo**

| diagram | | | | | |
|-----------|---|------|-------|---------|----------------|
| namespace | urn:www.agenziaentrate.gov.it:specificheTecniche:sco:730 | | | | |
| type | DatoNP_Type | | | | |
| facets | <table border="1"> <thead> <tr> <th>Kind</th> <th>Value</th> </tr> </thead> <tbody> <tr> <td>pattern</td> <td>[1-9]{1}[0-9]*</td> </tr> </tbody> </table> | Kind | Value | pattern | [1-9]{1}[0-9]* |
| Kind | Value | | | | |
| pattern | [1-9]{1}[0-9]* | | | | |

complexType **Spese_Rateizzate_Anni_Precedenti_Type**

| | |
|-----------|--|
| diagram | |
| namespace | urn:www.agenziaentrate.gov.it:specificheTecniche:sco:730 |
| children | m730:Codice m730:Importo |

element **Spese_Rateizzate_Anni_Precedenti_Type/Codice**

| diagram | | | | | | | | | | | |
|-------------|--|------|-------|---------|----------------|-------------|---|-------------|---|-------------|---|
| namespace | urn:www.agenziaentrate.gov.it:specificheTecniche:sco:730 | | | | | | | | | | |
| type | m730:Codice_Spese_Rateizzate_Anni_Precedenti_Type | | | | | | | | | | |
| facets | <table border="1"> <thead> <tr> <th>Kind</th> <th>Value</th> </tr> </thead> <tbody> <tr> <td>pattern</td> <td>[1-9]{1}[0-9]*</td> </tr> <tr> <td>enumeration</td> <td>2</td> </tr> <tr> <td>enumeration</td> <td>3</td> </tr> <tr> <td>enumeration</td> <td>4</td> </tr> </tbody> </table> | Kind | Value | pattern | [1-9]{1}[0-9]* | enumeration | 2 | enumeration | 3 | enumeration | 4 |
| Kind | Value | | | | | | | | | | |
| pattern | [1-9]{1}[0-9]* | | | | | | | | | | |
| enumeration | 2 | | | | | | | | | | |
| enumeration | 3 | | | | | | | | | | |
| enumeration | 4 | | | | | | | | | | |

element **Spese_Rateizzate_Anni_Precedenti_Type/Importo**

| | |
|-----------|--|
| diagram | |
| namespace | urn:www.agenziaentrate.gov.it:specificheTecniche:sco:730 |

| type | DatoNP_Type | | | | |
|---------|---|------|-------|---------|----------------|
| facets | <table border="1"> <tr> <th>Kind</th> <th>Value</th> </tr> <tr> <td>pattern</td> <td>[1-9]{1}[0-9]*</td> </tr> </table> | Kind | Value | pattern | [1-9]{1}[0-9]* |
| Kind | Value | | | | |
| pattern | [1-9]{1}[0-9]* | | | | |

complexType Spese_Rateizzate_Type

| | |
|-----------|--|
| diagram | |
| namespace | urn:www.agenziaentrate.gov.it:specificheTecniche:sco:730 |
| children | m730:Codice m730:Importo |

element Spese_Rateizzate_Type/Codice

| diagram | | | | | | | | | | | | | |
|-------------|---|------|-------|---------|----------------|-------------|---|-------------|---|-------------|---|-------------|---|
| namespace | urn:www.agenziaentrate.gov.it:specificheTecniche:sco:730 | | | | | | | | | | | | |
| type | m730:Codice Spese_Rateizzate_Type | | | | | | | | | | | | |
| facets | <table border="1"> <tr> <th>Kind</th> <th>Value</th> </tr> <tr> <td>pattern</td> <td>[1-9]{1}[0-9]*</td> </tr> <tr> <td>enumeration</td> <td>1</td> </tr> <tr> <td>enumeration</td> <td>2</td> </tr> <tr> <td>enumeration</td> <td>3</td> </tr> <tr> <td>enumeration</td> <td>4</td> </tr> </table> | Kind | Value | pattern | [1-9]{1}[0-9]* | enumeration | 1 | enumeration | 2 | enumeration | 3 | enumeration | 4 |
| Kind | Value | | | | | | | | | | | | |
| pattern | [1-9]{1}[0-9]* | | | | | | | | | | | | |
| enumeration | 1 | | | | | | | | | | | | |
| enumeration | 2 | | | | | | | | | | | | |
| enumeration | 3 | | | | | | | | | | | | |
| enumeration | 4 | | | | | | | | | | | | |

element Spese_Rateizzate_Type/Importo

| diagram | | | | | |
|-----------|---|------|-------|---------|----------------|
| namespace | urn:www.agenziaentrate.gov.it:specificheTecniche:sco:730 | | | | |
| type | DatoNP_Type | | | | |
| facets | <table border="1"> <tr> <th>Kind</th> <th>Value</th> </tr> <tr> <td>pattern</td> <td>[1-9]{1}[0-9]*</td> </tr> </table> | Kind | Value | pattern | [1-9]{1}[0-9]* |
| Kind | Value | | | | |
| pattern | [1-9]{1}[0-9]* | | | | |

complexType Tassazione_Separata_Type

| | |
|-----------|---|
| diagram | |
| namespace | urn:www.agenziaentrate.gov.it:specificheTecniche:sco:730 |
| children | m730:Opzione m730:Anno m730:RedditoRitenute |

element Tassazione_Separata_Type/Opzione

| diagram | | | | | |
|-----------|---|------|-------|---------|------|
| namespace | urn:www.agenziaentrate.gov.it:specificheTecniche:sco:730 | | | | |
| type | DatoCB_Type | | | | |
| facets | <table border="1"> <thead> <tr> <th>Kind</th> <th>Value</th> </tr> </thead> <tbody> <tr> <td>pattern</td> <td>[01]</td> </tr> </tbody> </table> | Kind | Value | pattern | [01] |
| Kind | Value | | | | |
| pattern | [01] | | | | |

element Tassazione_Separata_Type/Anno

| diagram | | | | | |
|-----------|---|------|-------|---------|--------------------|
| namespace | urn:www.agenziaentrate.gov.it:specificheTecniche:sco:730 | | | | |
| type | DatoDA_Type | | | | |
| facets | <table border="1"> <thead> <tr> <th>Kind</th> <th>Value</th> </tr> </thead> <tbody> <tr> <td>pattern</td> <td>(18 19 20)[0-9]{2}</td> </tr> </tbody> </table> | Kind | Value | pattern | (18 19 20)[0-9]{2} |
| Kind | Value | | | | |
| pattern | (18 19 20)[0-9]{2} | | | | |

element Tassazione_Separata_Type/RedditoRitenute

| | |
|-----------|--|
| diagram | |
| namespace | urn:www.agenziaentrate.gov.it:specificheTecniche:sco:730 |
| type | m730:Redditi_Ritenute_Type |
| children | m730:ImportoRedditi m730:ImportoRitenute |

complexType **Terreno_Type**

| | |
|-----------|--|
| diagram | |
| namespace | urn:www.agenziaentrate.gov.it:specificheTecniche:sco:730 |
| children | m730:RedDominicale m730:Titolo m730:RedAgrario m730:GiorniPossesso m730:PercPossesso m730:CanoneVincolistico m730:CasiParticolari m730:CasellaContinuazione m730:CasellaImmuNonDovuta m730:CasellaColtivatoreDiretto |

element **Terreno_Type/RedDominicale**

| diagram | | | | | |
|-----------|---|------|-------|---------|----------------|
| namespace | urn:www.agenziaentrate.gov.it:specificheTecniche:sco:730 | | | | |
| type | DatoNP_Type | | | | |
| facets | <table border="1"> <thead> <tr> <th>Kind</th> <th>Value</th> </tr> </thead> <tbody> <tr> <td>pattern</td> <td>[1-9]{1}[0-9]*</td> </tr> </tbody> </table> | Kind | Value | pattern | [1-9]{1}[0-9]* |
| Kind | Value | | | | |
| pattern | [1-9]{1}[0-9]* | | | | |

element **Terreno_Type/Titolo**

| diagram | | | | | | | | | | | | | | | | | | | |
|-------------|--|------|-------|---------|----------------|-------------|---|-------------|---|-------------|---|-------------|---|-------------|---|-------------|---|-------------|---|
| namespace | urn:www.agenziaentrate.gov.it:specificheTecniche:sco:730 | | | | | | | | | | | | | | | | | | |
| type | m730:TitoloTerreno_Type | | | | | | | | | | | | | | | | | | |
| facets | <table border="1"> <thead> <tr> <th>Kind</th> <th>Value</th> </tr> </thead> <tbody> <tr> <td>pattern</td> <td>[1-9]{1}[0-9]*</td> </tr> <tr> <td>enumeration</td> <td>1</td> </tr> <tr> <td>enumeration</td> <td>2</td> </tr> <tr> <td>enumeration</td> <td>3</td> </tr> <tr> <td>enumeration</td> <td>4</td> </tr> <tr> <td>enumeration</td> <td>5</td> </tr> <tr> <td>enumeration</td> <td>6</td> </tr> <tr> <td>enumeration</td> <td>7</td> </tr> </tbody> </table> | Kind | Value | pattern | [1-9]{1}[0-9]* | enumeration | 1 | enumeration | 2 | enumeration | 3 | enumeration | 4 | enumeration | 5 | enumeration | 6 | enumeration | 7 |
| Kind | Value | | | | | | | | | | | | | | | | | | |
| pattern | [1-9]{1}[0-9]* | | | | | | | | | | | | | | | | | | |
| enumeration | 1 | | | | | | | | | | | | | | | | | | |
| enumeration | 2 | | | | | | | | | | | | | | | | | | |
| enumeration | 3 | | | | | | | | | | | | | | | | | | |
| enumeration | 4 | | | | | | | | | | | | | | | | | | |
| enumeration | 5 | | | | | | | | | | | | | | | | | | |
| enumeration | 6 | | | | | | | | | | | | | | | | | | |
| enumeration | 7 | | | | | | | | | | | | | | | | | | |

| | |
|-------------|----|
| enumeration | 10 |
|-------------|----|

element Terreno_Type/RedAgrario

| | |
|-----------|---|
| diagram |  |
| namespace | urn:www.agenziaentrate.gov.it:specificheTecniche:sco:730 |
| type | DatoNP_Type |
| facets | Kind Value pattern [1-9]{1}[0-9]* |

element Terreno_Type/GiorniPossesso

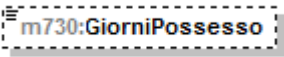
| | |
|-----------|--|
| diagram |  |
| namespace | urn:www.agenziaentrate.gov.it:specificheTecniche:sco:730 |
| type | DatoGA_Type |
| facets | Kind Value pattern [1-9](((1-9)[0-9]) ((12)[0-9][0-9]) (3[0-5][0-9]) (36[0-5])) |

element Terreno_Type/PercPossesso

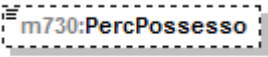
| | |
|-----------|---|
| diagram |  |
| namespace | urn:www.agenziaentrate.gov.it:specificheTecniche:sco:730 |
| type | DatoPC_Type |
| facets | Kind Value pattern [0-9]?[0-9](,\d{1,3})? 100,(0{1,3})? |

element Terreno_Type/CanoneVincolistico

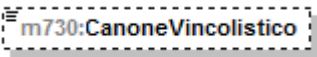
| | |
|-----------|---|
| diagram |  |
| namespace | urn:www.agenziaentrate.gov.it:specificheTecniche:sco:730 |
| type | DatoNP_Type |
| facets | Kind Value pattern [1-9]{1}[0-9]* |

element Terreno_Type/CasiParticolari

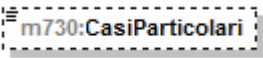
| | |
|-----------|---|
| diagram |  |
| namespace | urn:www.agenziaentrate.gov.it:specificheTecniche:sco:730 |
| type | m730:CasiParticolariTerreni_Type |
| facets | Kind Value |

| | | |
|--|-------------|-------|
| | pattern | [1-9] |
| | enumeration | 2 |
| | enumeration | 3 |
| | enumeration | 4 |
| | enumeration | 6 |

element Terreno_Type/CasellaContinuazione

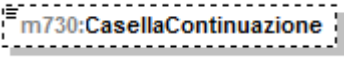
| | |
|-----------|---|
| diagram |  |
| namespace | urn:www.agenziaentrate.gov.it:specificheTecniche:sco:730 |
| type | DatoCB_Type |
| facets | Kind Value pattern [01] |

element Terreno_Type/CasellalmuNonDovuta

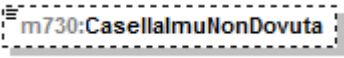
| | |
|-----------|---|
| diagram |  |
| namespace | urn:www.agenziaentrate.gov.it:specificheTecniche:sco:730 |
| type | restriction of DatoN1_Type |
| facets | Kind Value pattern [1-9] enumeration 1 enumeration 2 enumeration 3 |

element Terreno_Type/CasellaColtivatoreDiretto

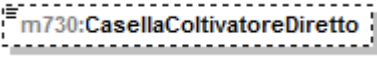
| | |
|-----------|---|
| diagram |  |
| namespace | urn:www.agenziaentrate.gov.it:specificheTecniche:sco:730 |
| type | DatoCB_Type |
| facets | Kind Value pattern [01] |

element ElencoFonti

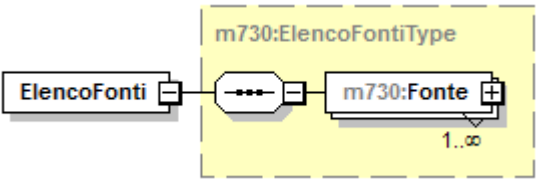
| | |
|-----------|---|
| diagram |  |
| namespace | urn:www.agenziaentrate.gov.it:specificheTecniche:sco:730 |
| type | m730:ElencoFontiType |
| children | m730:Fonte |

element Sintetico730

| | |
|-----------|--|
| diagram | |
| namespace | urn:www.agenziaentrate.gov.it:specificheTecniche:sco:730 |
| children | m730:DatiAnagrafici m730:DataElaborazione m730:ElencoFonti |

element Sintetico730/DatiAnagrafici

| | |
|-----------|--|
| diagram | |
| namespace | urn:www.agenziaentrate.gov.it:specificheTecniche:sco:730 |
| type | m730:DatiAnagraficiType |
| children | m730:Anagrafica |

element Sintetico730/DataElaborazione

| diagram | | | | | |
|-----------|---|------|-------|---------|--|
| namespace | urn:www.agenziaentrate.gov.it:specificheTecniche:sco:730 | | | | |
| type | m730:DataType | | | | |
| facets | <table border="1"> <thead> <tr> <th>Kind</th> <th>Value</th> </tr> </thead> <tbody> <tr> <td>pattern</td> <td>((([0-9]{1,2}[0-9]{3,4}) ([0-9]{1,2}[0-9]{3,4}) ([0-9]{1,2}[0-9]{3,4}) ([0-9]{1,2}[0-9]{3,4}) ([0-9]{1,2}[0-9]{3,4}) ([0-9]{1,2}[0-9]{3,4}) ([0-9]{1,2}[0-9]{3,4}) ([0-9]{1,2}[0-9]{3,4}) ([0-9]{1,2}[0-9]{3,4}) ([0-9]{1,2}[0-9]{3,4})) ([0-9]{1,2}[0-9]{3,4}) ([0-9]{1,2}[0-9]{3,4}) ([0-9]{1,2}[0-9]{3,4}) ([0-9]{1,2}[0-9]{3,4}) ([0-9]{1,2}[0-9]{3,4}) ([0-9]{1,2}[0-9]{3,4}) ([0-9]{1,2}[0-9]{3,4}) ([0-9]{1,2}[0-9]{3,4}) ([0-9]{1,2}[0-9]{3,4}))</td> </tr> </tbody> </table> | Kind | Value | pattern | ((([0-9]{1,2}[0-9]{3,4}) ([0-9]{1,2}[0-9]{3,4}) ([0-9]{1,2}[0-9]{3,4}) ([0-9]{1,2}[0-9]{3,4}) ([0-9]{1,2}[0-9]{3,4}) ([0-9]{1,2}[0-9]{3,4}) ([0-9]{1,2}[0-9]{3,4}) ([0-9]{1,2}[0-9]{3,4}) ([0-9]{1,2}[0-9]{3,4}) ([0-9]{1,2}[0-9]{3,4})) ([0-9]{1,2}[0-9]{3,4}) ([0-9]{1,2}[0-9]{3,4}) ([0-9]{1,2}[0-9]{3,4}) ([0-9]{1,2}[0-9]{3,4}) ([0-9]{1,2}[0-9]{3,4}) ([0-9]{1,2}[0-9]{3,4}) ([0-9]{1,2}[0-9]{3,4}) ([0-9]{1,2}[0-9]{3,4}) ([0-9]{1,2}[0-9]{3,4})) |
| Kind | Value | | | | |
| pattern | ((([0-9]{1,2}[0-9]{3,4}) ([0-9]{1,2}[0-9]{3,4}) ([0-9]{1,2}[0-9]{3,4}) ([0-9]{1,2}[0-9]{3,4}) ([0-9]{1,2}[0-9]{3,4}) ([0-9]{1,2}[0-9]{3,4}) ([0-9]{1,2}[0-9]{3,4}) ([0-9]{1,2}[0-9]{3,4}) ([0-9]{1,2}[0-9]{3,4}) ([0-9]{1,2}[0-9]{3,4})) ([0-9]{1,2}[0-9]{3,4}) ([0-9]{1,2}[0-9]{3,4}) ([0-9]{1,2}[0-9]{3,4}) ([0-9]{1,2}[0-9]{3,4}) ([0-9]{1,2}[0-9]{3,4}) ([0-9]{1,2}[0-9]{3,4}) ([0-9]{1,2}[0-9]{3,4}) ([0-9]{1,2}[0-9]{3,4}) ([0-9]{1,2}[0-9]{3,4})) | | | | |

complexType AnagraficaType

| | |
|-----------|---|
| diagram | |
| namespace | urn:www.agenziaentrate.gov.it:specificheTecniche:sco:730 |
| children | m730:CodiceFiscale m730:Nome m730:Cognome |

element AnagraficaType/CodiceFiscale

| | |
|-----------|--|
| diagram | |
| namespace | urn:www.agenziaentrate.gov.it:specificheTecniche:sco:730 |
| type | xs:string |

element AnagraficaType/Nome

| | |
|-----------|--|
| diagram | |
| namespace | urn:www.agenziaentrate.gov.it:specificheTecniche:sco:730 |
| type | xs:string |

element AnagraficaType/Cognome

| | |
|-----------|--|
| diagram | |
| namespace | urn:www.agenziaentrate.gov.it:specificheTecniche:sco:730 |
| type | xs:string |

complexType DatiAnagraficiType

| | |
|-----------|--|
| diagram | |
| namespace | urn:www.agenziaentrate.gov.it:specificheTecniche:sco:730 |
| children | m730:Anagrafica |

element DatiAnagraficiType/Anagrafica

| | |
|-----------|---|
| diagram | |
| namespace | urn:www.agenziaentrate.gov.it:specificheTecniche:sco:730 |
| type | m730:AnagraficaType |
| children | m730:CodiceFiscale m730:Nome m730:Cognome |

complexType **DettaglioFonteType**

| | |
|-----------|--|
| diagram | |
| namespace | urn:www.agenziaentrate.gov.it:specificheTecniche:sco:730 |
| children | m730:Testata m730:TestataImporto m730:TestataUtilizzo m730:Dettaglio |

element **DettaglioFonteType/Testata**

| | |
|-----------|--|
| diagram | |
| namespace | urn:www.agenziaentrate.gov.it:specificheTecniche:sco:730 |
| type | xs:string |

element **DettaglioFonteType/TestataImporto**

| | |
|-----------|--|
| diagram | |
| namespace | urn:www.agenziaentrate.gov.it:specificheTecniche:sco:730 |
| type | xs:string |

element **DettaglioFonteType/TestataUtilizzo**

| | |
|-----------|--|
| diagram | |
| namespace | urn:www.agenziaentrate.gov.it:specificheTecniche:sco:730 |
| type | xs:string |

element DettaglioFonteType/Dettaglio

| | |
|-----------|---|
| diagram | |
| namespace | urn:www.agenziaentrate.gov.it:specificheTecniche:sco:730 |
| type | m730:DettaglioType |
| children | m730:Contenuto m730:Importo m730:Utilizzo |

complexType DettaglioType

| | |
|-----------|---|
| diagram | |
| namespace | urn:www.agenziaentrate.gov.it:specificheTecniche:sco:730 |
| children | m730:Contenuto m730:Importo m730:Utilizzo |

element DettaglioType/Contenuto

| | |
|-----------|--|
| diagram | |
| namespace | urn:www.agenziaentrate.gov.it:specificheTecniche:sco:730 |
| type | xs:string |

element DettaglioType/Importo

| | | | | | |
|-----------|--|------|-------|---------|-----------------------|
| diagram | | | | | |
| namespace | urn:www.agenziaentrate.gov.it:specificheTecniche:sco:730 | | | | |
| type | m730:ImportoType | | | | |
| facets | <table border="1"> <tr> <td>Kind</td> <td>Value</td> </tr> <tr> <td>pattern</td> <td>(\-[1-9] [1-9])[0-9]*</td> </tr> </table> | Kind | Value | pattern | (\-[1-9] [1-9])[0-9]* |
| Kind | Value | | | | |
| pattern | (\-[1-9] [1-9])[0-9]* | | | | |

element **DettaglioType/Utilizzo**

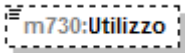
| | |
|-----------|---|
| diagram |  |
| namespace | urn:www.agenziaentrate.gov.it:specificheTecniche:sco:730 |
| type | xs:string |

complexType **ElencoFontiType**

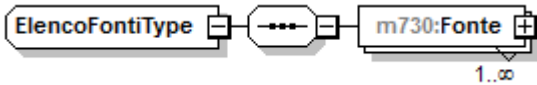
| | |
|-----------|---|
| diagram |  |
| namespace | urn:www.agenziaentrate.gov.it:specificheTecniche:sco:730 |
| children | m730:Fonte |

element **ElencoFontiType/Fonte**

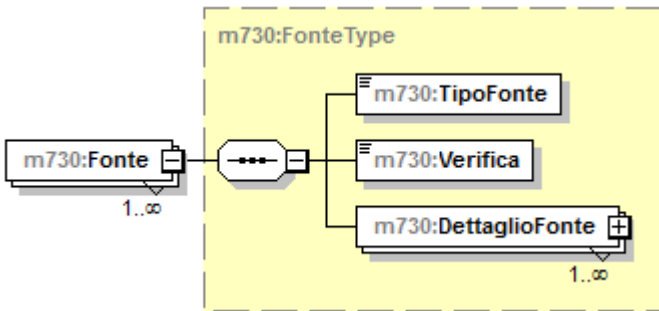
| | |
|-----------|--|
| diagram |  |
| namespace | urn:www.agenziaentrate.gov.it:specificheTecniche:sco:730 |
| type | m730:FonteType |
| children | m730:TipoFonte m730:Verifica m730:DettaglioFonte |

complexType **FonteType**

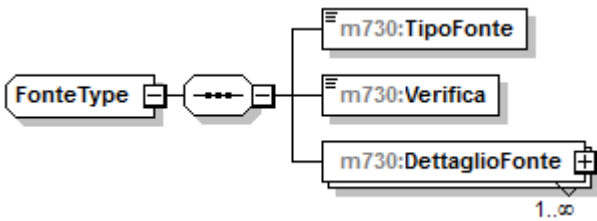
| | |
|-----------|--|
| diagram |  |
| namespace | urn:www.agenziaentrate.gov.it:specificheTecniche:sco:730 |
| children | m730:TipoFonte m730:Verifica m730:DettaglioFonte |

element FonteType/TipoFonte

| | |
|-----------|--|
| diagram | |
| namespace | urn:www.agenziaentrate.gov.it:specificheTecniche:sco:730 |
| type | xs:string |

element FonteType/Verifica

| | |
|-----------|--|
| diagram | |
| namespace | urn:www.agenziaentrate.gov.it:specificheTecniche:sco:730 |
| type | xs:int |

element FonteType/DettaglioFonte

| | |
|-----------|--|
| diagram | |
| namespace | urn:www.agenziaentrate.gov.it:specificheTecniche:sco:730 |
| type | m730:DettaglioFonteType |
| children | m730:Testata m730:TestataImporto m730:TestataUtilizzo m730:Dettaglio |

simpleType DataType

| namespace | urn:www.agenziaentrate.gov.it:specificheTecniche:sco:730 | | | | |
|-----------|---|------|-------|---------|--|
| type | restriction of xs:string | | | | |
| facets | <table border="1"> <thead> <tr> <th>Kind</th> <th>Value</th> </tr> </thead> <tbody> <tr> <td>pattern</td> <td>((([0-9]{1,12} [12][0-9]{3} [01])(0[13578] 10 12)\d{4}) ((([0-9]{1,9} [12][0-9]{30})(0[469] 11)\d{4}) ((([0-9]{1,9} [0-9]{2[0-8]})(02)\d{4}) ((29)(02)([02468][048]00)) ((29)(02)([13579][26]00)) ((29)(02)([0-9][0-9][0][48])) ((29)(02)([0-9][2468][048])) ((29)(02)([0-9][0-9][13579][26]))))</td> </tr> </tbody> </table> | Kind | Value | pattern | ((([0-9]{1,12} [12][0-9]{3} [01])(0[13578] 10 12)\d{4}) ((([0-9]{1,9} [12][0-9]{30})(0[469] 11)\d{4}) ((([0-9]{1,9} [0-9]{2[0-8]})(02)\d{4}) ((29)(02)([02468][048]00)) ((29)(02)([13579][26]00)) ((29)(02)([0-9][0-9][0][48])) ((29)(02)([0-9][2468][048])) ((29)(02)([0-9][0-9][13579][26])))) |
| Kind | Value | | | | |
| pattern | ((([0-9]{1,12} [12][0-9]{3} [01])(0[13578] 10 12)\d{4}) ((([0-9]{1,9} [12][0-9]{30})(0[469] 11)\d{4}) ((([0-9]{1,9} [0-9]{2[0-8]})(02)\d{4}) ((29)(02)([02468][048]00)) ((29)(02)([13579][26]00)) ((29)(02)([0-9][0-9][0][48])) ((29)(02)([0-9][2468][048])) ((29)(02)([0-9][0-9][13579][26])))) | | | | |

simpleType ImportoType

| namespace | urn:www.agenziaentrate.gov.it:specificheTecniche:sco:730 | | | | |
|-----------|--|------|-------|---------|-----------------------|
| type | restriction of xs:string | | | | |
| facets | <table border="1"> <thead> <tr> <th>Kind</th> <th>Value</th> </tr> </thead> <tbody> <tr> <td>pattern</td> <td>(\-[1-9] [1-9])[0-9]*</td> </tr> </tbody> </table> | Kind | Value | pattern | (\-[1-9] [1-9])[0-9]* |
| Kind | Value | | | | |
| pattern | (\-[1-9] [1-9])[0-9]* | | | | |

| | | |
|--------|-----------------|--|
| facets | Kind pattern | Value ([0-9])([10-2])([1920][0-9][0-9]) |
|--------|-----------------|--|

simpleType DatoDA_Type

| | | |
|-----------|---|-----------------------------|
| namespace | urn:www.agenziaentrate.gov.it:specificheTecniche:common | |
| type | restriction of xs:string | |
| facets | Kind pattern | Value (18 19 20)[0-9]{2} |

simpleType DatoDN_Type

| | | |
|-----------|---|--|
| namespace | urn:www.agenziaentrate.gov.it:specificheTecniche:common | |
| type | restriction of xs:string | |
| facets | Kind pattern | Value (((0[1-9][12][0-9]3[01])(0[13578]10 12)\d{4})) (((0[1-9][12][0-9]30)(0[469]11)\d{4})) (((0[1-9]1[0-9]2[0-8])(02)\d{4})) (((29)(02)([02468][048]00)) ((29)(02)([13579][26]00)) ((29)(02)([0-9][0][48])) ((29)(02)([0-9][2468][048])) ((29)(02)([0-9][0-9][13579][26])))) |

simpleType DatoDT_Type

| | | |
|-----------|---|--|
| namespace | urn:www.agenziaentrate.gov.it:specificheTecniche:common | |
| type | restriction of xs:string | |
| facets | Kind pattern | Value (((0[1-9][12][0-9]3[01])(0[13578]10 12)\d{4})) (((0[1-9][12][0-9]30)(0[469]11)\d{4})) (((0[1-9]1[0-9]2[0-8])(02)\d{4})) (((29)(02)([02468][048]00)) ((29)(02)([13579][26]00)) ((29)(02)([0-9][0][48])) ((29)(02)([0-9][2468][048])) ((29)(02)([0-9][0-9][13579][26])))) |

simpleType DatoEM_Type

| | | |
|-----------|---|---|
| namespace | urn:www.agenziaentrate.gov.it:specificheTecniche:common | |
| type | restriction of xs:string | |
| facets | Kind pattern | Value [a-zA-Z0-9_%\-'"?^~=]+@[a-zA-Z0-9\.-]+\.[a-zA-Z]{2,4} |

simpleType DatoGA_Type

| | | |
|-----------|---|--|
| namespace | urn:www.agenziaentrate.gov.it:specificheTecniche:common | |
| type | restriction of xs:string | |
| facets | Kind pattern | Value [1-9]([1-9][0-9])?([12][0-9][0-9])?(3[0-5][0-9])?(36[0-5])? |

simpleType DatoN1_Type

| | | |
|-----------|---|----------------|
| namespace | urn:www.agenziaentrate.gov.it:specificheTecniche:common | |
| type | restriction of xs:string | |
| facets | Kind pattern | Value [1-9] |

simpleType DatoNP_Type

| | | | | | |
|-----------|---|------|-------|---------|----------------|
| namespace | urn:www.agenziaentrate.gov.it:specificheTecniche:common | | | | |
| type | restriction of xs:string | | | | |
| facets | <table border="1"> <tr> <td>Kind</td> <td>Value</td> </tr> <tr> <td>pattern</td> <td>[1-9]{1}[0-9]*</td> </tr> </table> | Kind | Value | pattern | [1-9]{1}[0-9]* |
| Kind | Value | | | | |
| pattern | [1-9]{1}[0-9]* | | | | |

simpleType DatoNU_Type

| | | | | | |
|-----------|--|------|-------|---------|-----------------------|
| namespace | urn:www.agenziaentrate.gov.it:specificheTecniche:common | | | | |
| type | restriction of xs:string | | | | |
| facets | <table border="1"> <tr> <td>Kind</td> <td>Value</td> </tr> <tr> <td>pattern</td> <td>(\-[1-9] [1-9])[0-9]*</td> </tr> </table> | Kind | Value | pattern | (\-[1-9] [1-9])[0-9]* |
| Kind | Value | | | | |
| pattern | (\-[1-9] [1-9])[0-9]* | | | | |

simpleType DatoPC_Type

| | | | | | |
|-----------|---|------|-------|---------|------------------------------------|
| namespace | urn:www.agenziaentrate.gov.it:specificheTecniche:common | | | | |
| type | restriction of xs:string | | | | |
| facets | <table border="1"> <tr> <td>Kind</td> <td>Value</td> </tr> <tr> <td>pattern</td> <td>[0-9]?[0-9](,\d{1,3})? 100,0{1,3}?</td> </tr> </table> | Kind | Value | pattern | [0-9]?[0-9](,\d{1,3})? 100,0{1,3}? |
| Kind | Value | | | | |
| pattern | [0-9]?[0-9](,\d{1,3})? 100,0{1,3}? | | | | |

simpleType DatoPI_Type

| | | | | | |
|-----------|---|------|-------|---------|----------------|
| namespace | urn:www.agenziaentrate.gov.it:specificheTecniche:common | | | | |
| type | restriction of xs:string | | | | |
| facets | <table border="1"> <tr> <td>Kind</td> <td>Value</td> </tr> <tr> <td>pattern</td> <td>[0-7][0-9]{10}</td> </tr> </table> | Kind | Value | pattern | [0-7][0-9]{10} |
| Kind | Value | | | | |
| pattern | [0-7][0-9]{10} | | | | |

simpleType DatoQU_Type

| | | | | | |
|-----------|---|------|-------|---------|--------------------|
| namespace | urn:www.agenziaentrate.gov.it:specificheTecniche:common | | | | |
| type | restriction of xs:string | | | | |
| facets | <table border="1"> <tr> <td>Kind</td> <td>Value</td> </tr> <tr> <td>pattern</td> <td>[0-9]+,[0-9]{1,5}?</td> </tr> </table> | Kind | Value | pattern | [0-9]+,[0-9]{1,5}? |
| Kind | Value | | | | |
| pattern | [0-9]+,[0-9]{1,5}? | | | | |

simpleType DatoTL_Type

| | | | | | |
|-----------|---|------|-------|---------|--------|
| namespace | urn:www.agenziaentrate.gov.it:specificheTecniche:common | | | | |
| type | restriction of xs:string | | | | |
| facets | <table border="1"> <tr> <td>Kind</td> <td>Value</td> </tr> <tr> <td>pattern</td> <td>[0-9]*</td> </tr> </table> | Kind | Value | pattern | [0-9]* |
| Kind | Value | | | | |
| pattern | [0-9]* | | | | |

simpleType DatoVP_Type

| | | | | | |
|-----------|--|------|-------|---------|-----------------|
| namespace | urn:www.agenziaentrate.gov.it:specificheTecniche:common | | | | |
| type | restriction of xs:string | | | | |
| facets | <table border="1"> <tr> <td>Kind</td> <td>Value</td> </tr> <tr> <td>pattern</td> <td>[0-9]+,[0-9]{2}</td> </tr> </table> | Kind | Value | pattern | [0-9]+,[0-9]{2} |
| Kind | Value | | | | |
| pattern | [0-9]+,[0-9]{2} | | | | |

simpleType Anno_Anticipazione_Fondo_Pensione_Type

| | | |
|-----------|--|----------------|
| namespace | urn:www.agenziaentrate.gov.it:specificheTecniche:sco:730 | |
| type | restriction of DatoNP_Type | |
| facets | Kind | Value |
| | pattern | [1-9]{1}[0-9]* |
| | enumeration | 2007 |
| | enumeration | 2008 |
| | enumeration | 2009 |
| | enumeration | 2010 |
| | enumeration | 2011 |
| | enumeration | 2012 |
| | enumeration | 2013 |
| | enumeration | 2014 |

simpleType Anno_Patrimonio_Edilizio_Situazioni_Particolari_Type

| | | |
|-----------|--|----------------|
| namespace | urn:www.agenziaentrate.gov.it:specificheTecniche:sco:730 | |
| type | restriction of DatoNP_Type | |
| facets | Kind | Value |
| | pattern | [1-9]{1}[0-9]* |
| | enumeration | 2010 |
| | enumeration | 2011 |

simpleType Anno_Recupero_Patrimonio_Edilizio_Type

| | | |
|-----------|--|----------------|
| namespace | urn:www.agenziaentrate.gov.it:specificheTecniche:sco:730 | |
| type | restriction of DatoNP_Type | |
| facets | Kind | Value |
| | pattern | [1-9]{1}[0-9]* |
| | enumeration | 2005 |
| | enumeration | 2006 |
| | enumeration | 2007 |
| | enumeration | 2008 |
| | enumeration | 2009 |
| | enumeration | 2010 |
| | enumeration | 2011 |
| | enumeration | 2012 |
| | enumeration | 2013 |
| | enumeration | 2014 |

simpleType Anno_Risparmio_Energetico_Type

| | | |
|-----------|--|----------------|
| namespace | urn:www.agenziaentrate.gov.it:specificheTecniche:sco:730 | |
| type | restriction of DatoNP_Type | |
| facets | Kind | Value |
| | pattern | [1-9]{1}[0-9]* |
| | enumeration | 2008 |
| | enumeration | 2010 |
| | enumeration | 2011 |
| | enumeration | 2012 |
| | enumeration | 2013 |
| | enumeration | 2014 |

simpleType Casella_Codice_Type

| | | |
|-----------|--|-------|
| namespace | urn:www.agenziaentrate.gov.it:specificheTecniche:sco:730 | |
| type | restriction of DatoN1_Type | |
| facets | Kind | Value |
| | pattern | [1-9] |
| | enumeration | 1 |
| | enumeration | 4 |

simpleType Casella_Istruzioni_Type

| | | |
|-----------|--|-------|
| namespace | urn:www.agenziaentrate.gov.it:specificheTecniche:sco:730 | |
| type | restriction of DatoN1_Type | |
| facets | Kind | Value |
| | pattern | [1-9] |
| | enumeration | 1 |
| | enumeration | 2 |
| | enumeration | 3 |
| | enumeration | 4 |

simpleType Casi_Particolari_Risp_Ener_Type

| | | |
|-----------|--|-------|
| namespace | urn:www.agenziaentrate.gov.it:specificheTecniche:sco:730 | |
| type | restriction of DatoN1_Type | |
| facets | Kind | Value |
| | pattern | [1-9] |
| | enumeration | 1 |
| | enumeration | 2 |
| | enumeration | 3 |

simpleType CasiParticolariFabbricato_Type

| | | |
|-----------|--|-------|
| namespace | urn:www.agenziaentrate.gov.it:specificheTecniche:sco:730 | |
| type | restriction of DatoN1_Type | |
| facets | Kind | Value |
| | pattern | [1-9] |
| | enumeration | 1 |
| | enumeration | 3 |
| | enumeration | 4 |
| | enumeration | 5 |
| | enumeration | 6 |

simpleType CasiParticolariTerreni_Type

| | | |
|-----------|--|-------|
| namespace | urn:www.agenziaentrate.gov.it:specificheTecniche:sco:730 | |
| type | restriction of DatoN1_Type | |
| facets | Kind | Value |
| | pattern | [1-9] |
| | enumeration | 2 |
| | enumeration | 3 |
| | enumeration | 4 |
| | enumeration | 6 |

simpleType Codice_Altre_Detrazioni_Type

| | | |
|-----------|--|----------------|
| namespace | urn:www.agenziaentrate.gov.it:specificheTecniche:sco:730 | |
| type | restriction of DatoNP_Type | |
| facets | Kind | Value |
| | pattern | [1-9]{1}[0-9]* |
| | enumeration | 1 |
| | enumeration | 2 |

simpleType Codice_Altre_Spese_Type

| | | |
|-----------|--|----------------|
| namespace | urn:www.agenziaentrate.gov.it:specificheTecniche:sco:730 | |
| type | restriction of DatoNP_Type | |
| facets | Kind | Value |
| | pattern | [1-9]{1}[0-9]* |
| | enumeration | 8 |
| | enumeration | 9 |
| | enumeration | 10 |
| | enumeration | 11 |
| | enumeration | 13 |
| | enumeration | 14 |
| | enumeration | 15 |
| | enumeration | 16 |
| | enumeration | 17 |
| | enumeration | 18 |
| | enumeration | 20 |
| | enumeration | 21 |
| | enumeration | 22 |
| | enumeration | 23 |
| | enumeration | 24 |
| | enumeration | 25 |
| | enumeration | 26 |
| | enumeration | 27 |
| | enumeration | 28 |
| | enumeration | 29 |
| | enumeration | 30 |
| | enumeration | 31 |
| | enumeration | 32 |
| | enumeration | 33 |
| | enumeration | 35 |
| | enumeration | 36 |
| | enumeration | 37 |
| | enumeration | 41 |
| | enumeration | 42 |
| | enumeration | 99 |

simpleType Codice_Altri_Oneri_Type

| | | |
|-----------|--|----------------|
| namespace | urn:www.agenziaentrate.gov.it:specificheTecniche:sco:730 | |
| type | restriction of DatoNP_Type | |
| facets | Kind | Value |
| | pattern | [1-9]{1}[0-9]* |
| | enumeration | 1 |
| | enumeration | 2 |
| | enumeration | 3 |
| | enumeration | 4 |
| | enumeration | 5 |
| | enumeration | 6 |

simpleType Codice_Evento_Eccezionale_Type

| | | |
|-----------|--|-------|
| namespace | urn:www.agenziaentrate.gov.it:specificheTecniche:sco:730 | |
| type | restriction of DatoN1_Type | |
| facets | Kind | Value |
| | pattern | [1-9] |
| | enumeration | 1 |
| | enumeration | 2 |
| | enumeration | 3 |
| | enumeration | 4 |
| | enumeration | 5 |
| | enumeration | 6 |
| | enumeration | 7 |
| | enumeration | 8 |

simpleType Codice_Spese_Rateizzate_Anni_Precedenti_Type

| | | |
|-----------|--|----------------|
| namespace | urn:www.agenziaentrate.gov.it:specificheTecniche:sco:730 | |
| type | restriction of DatoNP_Type | |
| facets | Kind | Value |
| | pattern | [1-9]{1}[0-9]* |
| | enumeration | 2 |
| | enumeration | 3 |
| | enumeration | 4 |

simpleType Codice_Spese_Rateizzate_Type

| | | |
|-----------|--|----------------|
| namespace | urn:www.agenziaentrate.gov.it:specificheTecniche:sco:730 | |
| type | restriction of DatoNP_Type | |
| facets | Kind | Value |
| | pattern | [1-9]{1}[0-9]* |
| | enumeration | 1 |
| | enumeration | 2 |
| | enumeration | 3 |
| | enumeration | 4 |

simpleType CodiceCanone_Type

| | | |
|-----------|--|-------|
| namespace | urn:www.agenziaentrate.gov.it:specificheTecniche:sco:730 | |
| type | restriction of DatoN1_Type | |
| facets | Kind | Value |
| | pattern | [1-9] |
| | enumeration | 1 |
| | enumeration | 2 |
| | enumeration | 3 |
| | enumeration | 4 |

simpleType FabbricatoAgev_Numero_Rigo_Type

| | | |
|-----------|--|----------------|
| namespace | urn:www.agenziaentrate.gov.it:specificheTecniche:sco:730 | |
| type | restriction of DatoNP_Type | |
| facets | Kind | Value |
| | pattern | [1-9]{1}[0-9]* |
| | enumeration | 1 |
| | enumeration | 2 |
| | enumeration | 3 |

| | | |
|--|-------------|----|
| | enumeration | 4 |
| | enumeration | 5 |
| | enumeration | 6 |
| | enumeration | 7 |
| | enumeration | 8 |
| | enumeration | 9 |
| | enumeration | 10 |

simpleType Indeterminato_Determinato_Type

| | | |
|-----------|--|-------|
| namespace | urn:www.agenziaentrate.gov.it:specificheTecniche:sco:730 | |
| type | restriction of DatoN1_Type | |
| facets | Kind | Value |
| | pattern | [1-9] |
| | enumeration | 1 |
| | enumeration | 2 |

simpleType Integrativo_Type

| | | |
|-----------|--|-------|
| namespace | urn:www.agenziaentrate.gov.it:specificheTecniche:sco:730 | |
| type | restriction of DatoN1_Type | |
| facets | Kind | Value |
| | pattern | [1-9] |
| | enumeration | 1 |
| | enumeration | 2 |
| | enumeration | 3 |

simpleType Intero_Porzione_Type

| | | |
|-----------|--|--|
| namespace | urn:www.agenziaentrate.gov.it:specificheTecniche:sco:730 | |
| type | restriction of DatoAN_Type | |
| facets | Kind | Value |
| | pattern | (([0-9A-Z-])"){1}([0-9A-Z&:] ' - \., / ° °\^ \(\) À É È Ì Ò Ù Û " \N \\+)* |
| | enumeration | I |
| | enumeration | P |

simpleType Mesi_Type

| | | |
|-----------|--|----------------|
| namespace | urn:www.agenziaentrate.gov.it:specificheTecniche:sco:730 | |
| type | restriction of DatoNP_Type | |
| facets | Kind | Value |
| | pattern | [1-9]{1}[0-9]* |
| | enumeration | 1 |
| | enumeration | 2 |
| | enumeration | 3 |
| | enumeration | 4 |
| | enumeration | 5 |
| | enumeration | 6 |
| | enumeration | 7 |
| | enumeration | 8 |
| | enumeration | 9 |
| | enumeration | 10 |
| | enumeration | 11 |
| | enumeration | 12 |

simpleType Numero_Rata_Risparmi_Energetico_Type

| | | |
|-----------|--|----------------|
| namespace | urn:www.agenziaentrate.gov.it:specificheTecniche:sco:730 | |
| type | restriction of DatoNP_Type | |
| facets | Kind | Value |
| | pattern | [1-9]{1}[0-9]* |
| | enumeration | 1 |
| | enumeration | 2 |
| | enumeration | 3 |
| | enumeration | 4 |
| | enumeration | 5 |
| | enumeration | 6 |
| | enumeration | 7 |

simpleType Numero_Rate5o10_Type

| | | |
|-----------|--|----------------|
| namespace | urn:www.agenziaentrate.gov.it:specificheTecniche:sco:730 | |
| type | restriction of DatoNP_Type | |
| facets | Kind | Value |
| | pattern | [1-9]{1}[0-9]* |
| | enumeration | 5 |
| | enumeration | 10 |

simpleType Numero_RateDa1A2_Type

| | | |
|-----------|--|-------|
| namespace | urn:www.agenziaentrate.gov.it:specificheTecniche:sco:730 | |
| type | restriction of DatoN1_Type | |
| facets | Kind | Value |
| | pattern | [1-9] |
| | enumeration | 1 |
| | enumeration | 2 |

simpleType Numero_RateDa1A3_Type

| | | |
|-----------|--|-------|
| namespace | urn:www.agenziaentrate.gov.it:specificheTecniche:sco:730 | |
| type | restriction of DatoN1_Type | |
| facets | Kind | Value |
| | pattern | [1-9] |
| | enumeration | 1 |
| | enumeration | 2 |
| | enumeration | 3 |

simpleType Numero_RateDa1A4_Type

| | | |
|-----------|--|-------|
| namespace | urn:www.agenziaentrate.gov.it:specificheTecniche:sco:730 | |
| type | restriction of DatoN1_Type | |
| facets | Kind | Value |
| | pattern | [1-9] |
| | enumeration | 1 |
| | enumeration | 2 |
| | enumeration | 3 |
| | enumeration | 4 |

simpleType Numero_RateDa1A5_Type

| | | |
|-----------|--|-------|
| namespace | urn:www.agenziaentrate.gov.it:specificheTecniche:sco:730 | |
| type | restriction of DatoN1_Type | |
| facets | Kind | Value |
| | pattern | [1-9] |
| | enumeration | 1 |
| | enumeration | 2 |
| | enumeration | 3 |
| | enumeration | 4 |
| | enumeration | 5 |

simpleType Numero_RateDa1A6_Type

| | | |
|-----------|--|-------|
| namespace | urn:www.agenziaentrate.gov.it:specificheTecniche:sco:730 | |
| type | restriction of DatoN1_Type | |
| facets | Kind | Value |
| | pattern | [1-9] |
| | enumeration | 1 |
| | enumeration | 2 |
| | enumeration | 3 |
| | enumeration | 4 |
| | enumeration | 5 |
| | enumeration | 6 |

simpleType Numero_RateDa2A5_Type

| | | |
|-----------|--|----------------|
| namespace | urn:www.agenziaentrate.gov.it:specificheTecniche:sco:730 | |
| type | restriction of DatoNP_Type | |
| facets | Kind | Value |
| | pattern | [1-9]{1}[0-9]* |
| | enumeration | 2 |
| | enumeration | 3 |
| | enumeration | 4 |
| | enumeration | 5 |

simpleType Periodo_Spese_Ristrutturazione_Type

| | | |
|-----------|--|-------|
| namespace | urn:www.agenziaentrate.gov.it:specificheTecniche:sco:730 | |
| type | restriction of DatoN1_Type | |
| facets | Kind | Value |
| | pattern | [1-9] |
| | enumeration | 1 |
| | enumeration | 2 |
| | enumeration | 3 |
| | enumeration | 4 |

simpleType Rate10_Type

| | | |
|-----------|--|----------------|
| namespace | urn:www.agenziaentrate.gov.it:specificheTecniche:sco:730 | |
| type | restriction of DatoNP_Type | |
| facets | Kind | Value |
| | pattern | [1-9]{1}[0-9]* |
| | enumeration | 1 |
| | enumeration | 2 |
| | enumeration | 3 |

| | | |
|--|-------------|----|
| | enumeration | 4 |
| | enumeration | 5 |
| | enumeration | 6 |
| | enumeration | 7 |
| | enumeration | 8 |
| | enumeration | 9 |
| | enumeration | 10 |

simpleType Rate5_Type

| | | |
|-----------|--|----------------|
| namespace | urn:www.agenziaentrate.gov.it:specificheTecniche:sco:730 | |
| type | restriction of DatoNP_Type | |
| facets | Kind | Value |
| | pattern | [1-9]{1}[0-9]* |
| | enumeration | 4 |
| | enumeration | 5 |

simpleType Rate_Risparmio_Energetico_Type

| | | |
|-----------|--|----------------|
| namespace | urn:www.agenziaentrate.gov.it:specificheTecniche:sco:730 | |
| type | restriction of DatoNP_Type | |
| facets | Kind | Value |
| | pattern | [1-9]{1}[0-9]* |
| | enumeration | 3 |
| | enumeration | 4 |
| | enumeration | 5 |
| | enumeration | 6 |
| | enumeration | 7 |
| | enumeration | 8 |
| | enumeration | 9 |
| | enumeration | 10 |

simpleType Reintegro_Totale_Parziale_Type

| | | |
|-----------|--|-------|
| namespace | urn:www.agenziaentrate.gov.it:specificheTecniche:sco:730 | |
| type | restriction of DatoN1_Type | |
| facets | Kind | Value |
| | pattern | [1-9] |
| | enumeration | 1 |
| | enumeration | 2 |

simpleType Rettificativo_Type

| | | |
|-----------|--|-------|
| namespace | urn:www.agenziaentrate.gov.it:specificheTecniche:sco:730 | |
| type | restriction of DatoN1_Type | |
| facets | Kind | Value |
| | pattern | [1-9] |
| | enumeration | 1 |
| | enumeration | 2 |
| | enumeration | 3 |

simpleType Rideterminazione_Rate_Type

| | | |
|-----------|--|--|
| namespace | urn:www.agenziaentrate.gov.it:specificheTecniche:sco:730 | |
|-----------|--|--|

| | | | | | | | |
|-------------|---|------|-------|---------|----------------|-------------|----|
| type | restriction of DatoNP_Type | | | | | | |
| facets | <table border="1"> <tr> <td>Kind</td> <td>Value</td> </tr> <tr> <td>pattern</td> <td>[1-9]{1}[0-9]*</td> </tr> <tr> <td>enumeration</td> <td>10</td> </tr> </table> | Kind | Value | pattern | [1-9]{1}[0-9]* | enumeration | 10 |
| Kind | Value | | | | | | |
| pattern | [1-9]{1}[0-9]* | | | | | | |
| enumeration | 10 | | | | | | |

simpleType **Ripart_Risparmio_Energetico_Type**

| | | | | | | | | | | | | | | | | | | | |
|-------------|---|------|-------|---------|----------------|-------------|---|-------------|---|-------------|---|-------------|---|-------------|---|-------------|---|-------------|----|
| namespace | urn:www.agenziaentrate.gov.it:specificheTecniche:sco:730 | | | | | | | | | | | | | | | | | | |
| type | restriction of DatoNP_Type | | | | | | | | | | | | | | | | | | |
| facets | <table border="1"> <tr> <td>Kind</td> <td>Value</td> </tr> <tr> <td>pattern</td> <td>[1-9]{1}[0-9]*</td> </tr> <tr> <td>enumeration</td> <td>4</td> </tr> <tr> <td>enumeration</td> <td>5</td> </tr> <tr> <td>enumeration</td> <td>6</td> </tr> <tr> <td>enumeration</td> <td>7</td> </tr> <tr> <td>enumeration</td> <td>8</td> </tr> <tr> <td>enumeration</td> <td>9</td> </tr> <tr> <td>enumeration</td> <td>10</td> </tr> </table> | Kind | Value | pattern | [1-9]{1}[0-9]* | enumeration | 4 | enumeration | 5 | enumeration | 6 | enumeration | 7 | enumeration | 8 | enumeration | 9 | enumeration | 10 |
| Kind | Value | | | | | | | | | | | | | | | | | | |
| pattern | [1-9]{1}[0-9]* | | | | | | | | | | | | | | | | | | |
| enumeration | 4 | | | | | | | | | | | | | | | | | | |
| enumeration | 5 | | | | | | | | | | | | | | | | | | |
| enumeration | 6 | | | | | | | | | | | | | | | | | | |
| enumeration | 7 | | | | | | | | | | | | | | | | | | |
| enumeration | 8 | | | | | | | | | | | | | | | | | | |
| enumeration | 9 | | | | | | | | | | | | | | | | | | |
| enumeration | 10 | | | | | | | | | | | | | | | | | | |

simpleType **Serie_Registrazione_Contratto_Type**

| | | | | | | | | | | | | | | | |
|-------------|--|------|-------|---------|--|-------------|---|-------------|----|-------------|----|-------------|----|-------------|----|
| namespace | urn:www.agenziaentrate.gov.it:specificheTecniche:sco:730 | | | | | | | | | | | | | | |
| type | restriction of DatoAN_Type | | | | | | | | | | | | | | |
| facets | <table border="1"> <tr> <td>Kind</td> <td>Value</td> </tr> <tr> <td>pattern</td> <td>([0-9A-Z\-\-] &quot;){1}([0-9A-Z&amp;] " \- \., / \° \^ \(\) À È É Ì Ò Ù Ü &quot;;\ \\ \ +)*</td> </tr> <tr> <td>enumeration</td> <td>3</td> </tr> <tr> <td>enumeration</td> <td>3A</td> </tr> <tr> <td>enumeration</td> <td>3B</td> </tr> <tr> <td>enumeration</td> <td>3P</td> </tr> <tr> <td>enumeration</td> <td>3T</td> </tr> </table> | Kind | Value | pattern | ([0-9A-Z\-\-] "){1}([0-9A-Z&] " \- \., / \° \^ \(\) À È É Ì Ò Ù Ü ";\ \\ \ +)* | enumeration | 3 | enumeration | 3A | enumeration | 3B | enumeration | 3P | enumeration | 3T |
| Kind | Value | | | | | | | | | | | | | | |
| pattern | ([0-9A-Z\-\-] "){1}([0-9A-Z&] " \- \., / \° \^ \(\) À È É Ì Ò Ù Ü ";\ \\ \ +)* | | | | | | | | | | | | | | |
| enumeration | 3 | | | | | | | | | | | | | | |
| enumeration | 3A | | | | | | | | | | | | | | |
| enumeration | 3B | | | | | | | | | | | | | | |
| enumeration | 3P | | | | | | | | | | | | | | |
| enumeration | 3T | | | | | | | | | | | | | | |

simpleType **Stato_Civile_Coniuge_Type**

| | | | | | | | | | |
|-------------|---|------|-------|---------|----------------|-------------|---|-------------|---|
| namespace | urn:www.agenziaentrate.gov.it:specificheTecniche:sco:730 | | | | | | | | |
| type | restriction of DatoNP_Type | | | | | | | | |
| facets | <table border="1"> <tr> <td>Kind</td> <td>Value</td> </tr> <tr> <td>pattern</td> <td>[1-9]{1}[0-9]*</td> </tr> <tr> <td>enumeration</td> <td>2</td> </tr> <tr> <td>enumeration</td> <td>4</td> </tr> </table> | Kind | Value | pattern | [1-9]{1}[0-9]* | enumeration | 2 | enumeration | 4 |
| Kind | Value | | | | | | | | |
| pattern | [1-9]{1}[0-9]* | | | | | | | | |
| enumeration | 2 | | | | | | | | |
| enumeration | 4 | | | | | | | | |

simpleType **Stato_Civile_Type**

| | | | | | | | | | |
|-------------|---|------|-------|---------|----------------|-------------|---|-------------|---|
| namespace | urn:www.agenziaentrate.gov.it:specificheTecniche:sco:730 | | | | | | | | |
| type | restriction of DatoNP_Type | | | | | | | | |
| facets | <table border="1"> <tr> <td>Kind</td> <td>Value</td> </tr> <tr> <td>pattern</td> <td>[1-9]{1}[0-9]*</td> </tr> <tr> <td>enumeration</td> <td>7</td> </tr> <tr> <td>enumeration</td> <td>8</td> </tr> </table> | Kind | Value | pattern | [1-9]{1}[0-9]* | enumeration | 7 | enumeration | 8 |
| Kind | Value | | | | | | | | |
| pattern | [1-9]{1}[0-9]* | | | | | | | | |
| enumeration | 7 | | | | | | | | |
| enumeration | 8 | | | | | | | | |

simpleType **Terreni_Urbano_Type**

| | |
|-----------|--|
| namespace | urn:www.agenziaentrate.gov.it:specificheTecniche:sco:730 |
| type | restriction of DatoAN_Type |

| | | |
|--------|-------------|--|
| facets | Kind | Value |
| | pattern | ([0-9A-Z-])"){1}([0-9A-Z&:] ' - .!, /° ^\(\\) À É Ê Ï Ò Ó Ü " \\ \\ +)* |
| | enumeration | T |
| | enumeration | U |

simpleType Tipo_Fornitore_730_Type

| | | |
|-----------|--|----------------|
| namespace | urn:www.agenziaentrate.gov.it:specificheTecniche:sco:730 | |
| type | restriction of DatoNP_Type | |
| facets | Kind | Value |
| | pattern | [1-9]{1}[0-9]* |
| | enumeration | 1 |
| | enumeration | 3 |
| | enumeration | 5 |
| | enumeration | 10 |

simpleType Tipo_Inquilino_Type

| | | |
|-----------|--|----------------|
| namespace | urn:www.agenziaentrate.gov.it:specificheTecniche:sco:730 | |
| type | restriction of DatoNP_Type | |
| facets | Kind | Value |
| | pattern | [1-9]{1}[0-9]* |
| | enumeration | 1 |
| | enumeration | 2 |
| | enumeration | 3 |
| | enumeration | 4 |

simpleType Tipo_Intervento_Type

| | | |
|-----------|--|-------|
| namespace | urn:www.agenziaentrate.gov.it:specificheTecniche:sco:730 | |
| type | restriction of DatoN1_Type | |
| facets | Kind | Value |
| | pattern | [1-9] |
| | enumeration | 1 |
| | enumeration | 2 |
| | enumeration | 3 |
| | enumeration | 4 |

simpleType Tipo_Reddito_Da1a12_Type

| | | |
|-------------|--|----------------|
| namespace | urn:www.agenziaentrate.gov.it:specificheTecniche:sco:730 | |
| type | restriction of DatoNP_Type | |
| facets | Kind | Value |
| | pattern | [1-9]{1}[0-9]* |
| | enumeration | 1 |
| | enumeration | 2 |
| | enumeration | 3 |
| | enumeration | 4 |
| | enumeration | 5 |
| | enumeration | 6 |
| | enumeration | 7 |
| | enumeration | 8 |
| | enumeration | 9 |
| | enumeration | 10 |
| | enumeration | 11 |
| enumeration | 12 | |

simpleType Tipo_Redito_Da1a3_Type

| namespace | urn:www.agenziaentrate.gov.it:specificheTecniche:sco:730 | | | | | | | | | | |
|-------------|---|------|-------|---------|-------|-------------|---|-------------|---|-------------|---|
| type | restriction of DatoN1_Type | | | | | | | | | | |
| facets | <table border="1"> <thead> <tr> <th>Kind</th> <th>Value</th> </tr> </thead> <tbody> <tr> <td>pattern</td> <td>[1-9]</td> </tr> <tr> <td>enumeration</td> <td>1</td> </tr> <tr> <td>enumeration</td> <td>2</td> </tr> <tr> <td>enumeration</td> <td>3</td> </tr> </tbody> </table> | Kind | Value | pattern | [1-9] | enumeration | 1 | enumeration | 2 | enumeration | 3 |
| Kind | Value | | | | | | | | | | |
| pattern | [1-9] | | | | | | | | | | |
| enumeration | 1 | | | | | | | | | | |
| enumeration | 2 | | | | | | | | | | |
| enumeration | 3 | | | | | | | | | | |

simpleType Tipo_Redito_Da1a4_Type

| namespace | urn:www.agenziaentrate.gov.it:specificheTecniche:sco:730 | | | | | | | | | | | | |
|-------------|--|------|-------|---------|-------|-------------|---|-------------|---|-------------|---|-------------|---|
| type | restriction of DatoN1_Type | | | | | | | | | | | | |
| facets | <table border="1"> <thead> <tr> <th>Kind</th> <th>Value</th> </tr> </thead> <tbody> <tr> <td>pattern</td> <td>[1-9]</td> </tr> <tr> <td>enumeration</td> <td>1</td> </tr> <tr> <td>enumeration</td> <td>2</td> </tr> <tr> <td>enumeration</td> <td>3</td> </tr> <tr> <td>enumeration</td> <td>4</td> </tr> </tbody> </table> | Kind | Value | pattern | [1-9] | enumeration | 1 | enumeration | 2 | enumeration | 3 | enumeration | 4 |
| Kind | Value | | | | | | | | | | | | |
| pattern | [1-9] | | | | | | | | | | | | |
| enumeration | 1 | | | | | | | | | | | | |
| enumeration | 2 | | | | | | | | | | | | |
| enumeration | 3 | | | | | | | | | | | | |
| enumeration | 4 | | | | | | | | | | | | |

simpleType Tipo_Redito_Da1a6_Type

| namespace | urn:www.agenziaentrate.gov.it:specificheTecniche:sco:730 | | | | | | | | | | | | | | | | |
|-------------|--|------|-------|---------|-------|-------------|---|-------------|---|-------------|---|-------------|---|-------------|---|-------------|---|
| type | restriction of DatoN1_Type | | | | | | | | | | | | | | | | |
| facets | <table border="1"> <thead> <tr> <th>Kind</th> <th>Value</th> </tr> </thead> <tbody> <tr> <td>pattern</td> <td>[1-9]</td> </tr> <tr> <td>enumeration</td> <td>1</td> </tr> <tr> <td>enumeration</td> <td>2</td> </tr> <tr> <td>enumeration</td> <td>3</td> </tr> <tr> <td>enumeration</td> <td>4</td> </tr> <tr> <td>enumeration</td> <td>5</td> </tr> <tr> <td>enumeration</td> <td>6</td> </tr> </tbody> </table> | Kind | Value | pattern | [1-9] | enumeration | 1 | enumeration | 2 | enumeration | 3 | enumeration | 4 | enumeration | 5 | enumeration | 6 |
| Kind | Value | | | | | | | | | | | | | | | | |
| pattern | [1-9] | | | | | | | | | | | | | | | | |
| enumeration | 1 | | | | | | | | | | | | | | | | |
| enumeration | 2 | | | | | | | | | | | | | | | | |
| enumeration | 3 | | | | | | | | | | | | | | | | |
| enumeration | 4 | | | | | | | | | | | | | | | | |
| enumeration | 5 | | | | | | | | | | | | | | | | |
| enumeration | 6 | | | | | | | | | | | | | | | | |

simpleType Tipo_Redito_Da1a7_Type

| namespace | urn:www.agenziaentrate.gov.it:specificheTecniche:sco:730 | | | | | | | | | | | | | | | | | | |
|-------------|---|------|-------|---------|-------|-------------|---|-------------|---|-------------|---|-------------|---|-------------|---|-------------|---|-------------|---|
| type | restriction of DatoN1_Type | | | | | | | | | | | | | | | | | | |
| facets | <table border="1"> <thead> <tr> <th>Kind</th> <th>Value</th> </tr> </thead> <tbody> <tr> <td>pattern</td> <td>[1-9]</td> </tr> <tr> <td>enumeration</td> <td>1</td> </tr> <tr> <td>enumeration</td> <td>2</td> </tr> <tr> <td>enumeration</td> <td>3</td> </tr> <tr> <td>enumeration</td> <td>4</td> </tr> <tr> <td>enumeration</td> <td>5</td> </tr> <tr> <td>enumeration</td> <td>6</td> </tr> <tr> <td>enumeration</td> <td>7</td> </tr> </tbody> </table> | Kind | Value | pattern | [1-9] | enumeration | 1 | enumeration | 2 | enumeration | 3 | enumeration | 4 | enumeration | 5 | enumeration | 6 | enumeration | 7 |
| Kind | Value | | | | | | | | | | | | | | | | | | |
| pattern | [1-9] | | | | | | | | | | | | | | | | | | |
| enumeration | 1 | | | | | | | | | | | | | | | | | | |
| enumeration | 2 | | | | | | | | | | | | | | | | | | |
| enumeration | 3 | | | | | | | | | | | | | | | | | | |
| enumeration | 4 | | | | | | | | | | | | | | | | | | |
| enumeration | 5 | | | | | | | | | | | | | | | | | | |
| enumeration | 6 | | | | | | | | | | | | | | | | | | |
| enumeration | 7 | | | | | | | | | | | | | | | | | | |

simpleType Tipo_Redito_Da1a8_Type

| | |
|-----------|--|
| namespace | urn:www.agenziaentrate.gov.it:specificheTecniche:sco:730 |
| type | restriction of DatoNP_Type |

| | | |
|-------------|-------------|----------------|
| facets | Kind | Value |
| | pattern | [1-9]{1}[0-9]* |
| | enumeration | 1 |
| | enumeration | 2 |
| | enumeration | 3 |
| | enumeration | 4 |
| | enumeration | 5 |
| | enumeration | 6 |
| | enumeration | 7 |
| enumeration | 8 | |

simpleType Tipo_Reddito_Da1a9_Type

| | | |
|-------------|--|----------------|
| namespace | urn:www.agenziaentrate.gov.it:specificheTecniche:sco:730 | |
| type | restriction of DatoNP_Type | |
| facets | Kind | Value |
| | pattern | [1-9]{1}[0-9]* |
| | enumeration | 1 |
| | enumeration | 2 |
| | enumeration | 3 |
| | enumeration | 4 |
| | enumeration | 5 |
| | enumeration | 6 |
| | enumeration | 7 |
| enumeration | 8 | |
| enumeration | 9 | |

simpleType Tipologia_Soggetto_AssFisc_Type

| | | |
|-------------|--|-------|
| namespace | urn:www.agenziaentrate.gov.it:specificheTecniche:sco:730 | |
| type | restriction of DatoN1_Type | |
| facets | Kind | Value |
| | pattern | [1-9] |
| | enumeration | 1 |
| | enumeration | 2 |
| | enumeration | 3 |
| | enumeration | 4 |
| enumeration | 5 | |

simpleType TitoloTerreno_Type

| | | |
|-------------|--|----------------|
| namespace | urn:www.agenziaentrate.gov.it:specificheTecniche:sco:730 | |
| type | restriction of DatoNP_Type | |
| facets | Kind | Value |
| | pattern | [1-9]{1}[0-9]* |
| | enumeration | 1 |
| | enumeration | 2 |
| | enumeration | 3 |
| | enumeration | 4 |
| | enumeration | 5 |
| | enumeration | 6 |
| | enumeration | 7 |
| | enumeration | 8 |
| enumeration | 10 | |

simpleType Utilizzo_Fabbricato_Type

| | | |
|-----------|--|--|
| namespace | urn:www.agenziaentrate.gov.it:specificheTecniche:sco:730 | |
|-----------|--|--|

| | | |
|--------|--|----------------|
| type | restriction of DatoNP Type | |
| facets | Kind | Value |
| | pattern | [1-9]{1}[0-9]* |
| | enumeration | 1 |
| | enumeration | 2 |
| | enumeration | 3 |
| | enumeration | 4 |
| | enumeration | 5 |
| | enumeration | 8 |
| | enumeration | 9 |
| | enumeration | 10 |
| | enumeration | 11 |
| | enumeration | 12 |
| | enumeration | 14 |
| | enumeration | 15 |
| | enumeration | 16 |
| | enumeration | 17 |

element Documento

| | | | | | |
|------------|---|-------------------------------------|----------|---------|-------|
| diagram | | | | | |
| namespace | urn:www.agenziaentrate.gov.it:specificheTecniche:common | | | | |
| type | Documento Type | | | | |
| attributes | Name | Type | Use | Default | Fixed |
| | identificativo | Identificativo Type | required | | |

complexType Documento_Type

| | | | | | |
|------------|---|-------------------------------------|----------|---------|-------|
| diagram | | | | | |
| namespace | urn:www.agenziaentrate.gov.it:specificheTecniche:common | | | | |
| attributes | Name | Type | Use | Default | Fixed |
| | identificativo | Identificativo Type | required | | |

attribute Documento_Type/@identificativo

| | | |
|--------|-------------------------------------|---|
| type | Identificativo Type | |
| facets | Kind | Value |
| | pattern | [0-9]{4}[1-9][0-9]{3}[1-9][0-9][0-9]{2}[1-9][0-9]{2}[0-9][1-9][0-9]{3}[1-9][0-9]{4} |

simpleType Identificativo_Type

| | | | | | |
|-----------|---|------|-------|---------|--|
| namespace | urn:www.agenziaentrate.gov.it:specificheTecniche:common | | | | |
| type | restriction of xs:string | | | | |
| facets | <table border="1"> <tr> <td>Kind</td> <td>Value</td> </tr> <tr> <td>pattern</td> <td>[0-9]{4}[1-9] [0-9]{3}[1-9] [0-9]{2}[1-9] [0-9]{2} [0-9]{1-9} [0-9]{3} [1-9][0-9]{4}</td> </tr> </table> | Kind | Value | pattern | [0-9]{4}[1-9] [0-9]{3}[1-9] [0-9]{2}[1-9] [0-9]{2} [0-9]{1-9} [0-9]{3} [1-9][0-9]{4} |
| Kind | Value | | | | |
| pattern | [0-9]{4}[1-9] [0-9]{3}[1-9] [0-9]{2}[1-9] [0-9]{2} [0-9]{1-9} [0-9]{3} [1-9][0-9]{4} | | | | |

complexType Dati_Anagrafici_Type

| | |
|-----------|---|
| diagram | |
| namespace | urn:www.agenziaentrate.gov.it:specificheTecniche:sco:common |
| children | Cognome Nome Sesso DataNascita ComuneNascita ProvinciaNascita |

element Dati_Anagrafici_Type/Cognome

| | | | | | |
|-----------|---|------|-------|---------|--|
| diagram | | | | | |
| namespace | urn:www.agenziaentrate.gov.it:specificheTecniche:sco:common | | | | |
| type | DatoAN_Type | | | | |
| facets | <table border="1"> <tr> <td>Kind</td> <td>Value</td> </tr> <tr> <td>pattern</td> <td>(([0-9A-Z-] \&quot;){1}([0-9A-Z&amp;] ' \" _ . / ^\\(\\) À É È Ì Ò Ù Û &quot; \\ \\ +)*</td> </tr> </table> | Kind | Value | pattern | (([0-9A-Z-] \"){1}([0-9A-Z&] ' \" _ . / ^\\(\\) À É È Ì Ò Ù Û " \\ \\ +)* |
| Kind | Value | | | | |
| pattern | (([0-9A-Z-] \"){1}([0-9A-Z&] ' \" _ . / ^\\(\\) À É È Ì Ò Ù Û " \\ \\ +)* | | | | |

element Dati_Anagrafici_Type/Nome

| | | | | | |
|-----------|---|------|-------|---------|--|
| diagram | | | | | |
| namespace | urn:www.agenziaentrate.gov.it:specificheTecniche:sco:common | | | | |
| type | DatoAN_Type | | | | |
| facets | <table border="1"> <tr> <td>Kind</td> <td>Value</td> </tr> <tr> <td>pattern</td> <td>(([0-9A-Z-] \&quot;){1}([0-9A-Z&amp;] ' \" _ . / ^\\(\\) À É È Ì Ò Ù Û &quot; \\ \\ +)*</td> </tr> </table> | Kind | Value | pattern | (([0-9A-Z-] \"){1}([0-9A-Z&] ' \" _ . / ^\\(\\) À É È Ì Ò Ù Û " \\ \\ +)* |
| Kind | Value | | | | |
| pattern | (([0-9A-Z-] \"){1}([0-9A-Z&] ' \" _ . / ^\\(\\) À É È Ì Ò Ù Û " \\ \\ +)* | | | | |

element Dati_Anagrafici_Type/Sesso

| | |
|---------|--|
| diagram | |
|---------|--|

| | | | | | | | | | |
|-------------|---|------|-------|---------|--|-------------|---|-------------|---|
| namespace | urn:www.agenziaentrate.gov.it:specificheTecniche:sco:common | | | | | | | | |
| type | Sesso_Type | | | | | | | | |
| facets | <table border="0"> <tr> <td>Kind</td> <td>Value</td> </tr> <tr> <td>pattern</td> <td>(([0-9A-Z-])&quot;){1}([0-9A-Z&amp;:] ' - \. / ^ ^\ \\(\) À É È Ì Ò Ù Û &quot; \\N \\+)*</td> </tr> <tr> <td>enumeration</td> <td>M</td> </tr> <tr> <td>enumeration</td> <td>F</td> </tr> </table> | Kind | Value | pattern | (([0-9A-Z-])"){1}([0-9A-Z&:] ' - \. / ^ ^\ \\(\) À É È Ì Ò Ù Û " \\N \\+)* | enumeration | M | enumeration | F |
| Kind | Value | | | | | | | | |
| pattern | (([0-9A-Z-])"){1}([0-9A-Z&:] ' - \. / ^ ^\ \\(\) À É È Ì Ò Ù Û " \\N \\+)* | | | | | | | | |
| enumeration | M | | | | | | | | |
| enumeration | F | | | | | | | | |

element Dati_Anagrafici_Type/DataNascita

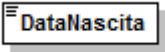
| | | | | | |
|-----------|--|------|-------|---------|---|
| diagram |  | | | | |
| namespace | urn:www.agenziaentrate.gov.it:specificheTecniche:sco:common | | | | |
| type | DatoDT_Type | | | | |
| facets | <table border="0"> <tr> <td>Kind</td> <td>Value</td> </tr> <tr> <td>pattern</td> <td>((([0-9]{1-9}){12}([0-9]{3} 01)))(0[13578][10 12](\d{4}))(((0[1-9]) 12 09 30)(0[469] 11)(\d{4}))(((0[1-9] 1[0-9] 2[0-8])(02)(\d{4})) ((29)(02)([02468][048]00)) ((29)(02)([13579][26]00)) ((29)(02)([0-9][0-9][048])) ((29)(02)([0-9][0-9][2468][048])) ((29)(02)([0-9][0-9][13579][26]))))</td> </tr> </table> | Kind | Value | pattern | ((([0-9]{1-9}){12}([0-9]{3} 01)))(0[13578][10 12](\d{4}))(((0[1-9]) 12 09 30)(0[469] 11)(\d{4}))(((0[1-9] 1[0-9] 2[0-8])(02)(\d{4})) ((29)(02)([02468][048]00)) ((29)(02)([13579][26]00)) ((29)(02)([0-9][0-9][048])) ((29)(02)([0-9][0-9][2468][048])) ((29)(02)([0-9][0-9][13579][26])))) |
| Kind | Value | | | | |
| pattern | ((([0-9]{1-9}){12}([0-9]{3} 01)))(0[13578][10 12](\d{4}))(((0[1-9]) 12 09 30)(0[469] 11)(\d{4}))(((0[1-9] 1[0-9] 2[0-8])(02)(\d{4})) ((29)(02)([02468][048]00)) ((29)(02)([13579][26]00)) ((29)(02)([0-9][0-9][048])) ((29)(02)([0-9][0-9][2468][048])) ((29)(02)([0-9][0-9][13579][26])))) | | | | |

element Dati_Anagrafici_Type/ComuneNascita

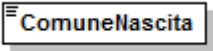
| | | | | | |
|-----------|---|------|-------|---------|--|
| diagram |  | | | | |
| namespace | urn:www.agenziaentrate.gov.it:specificheTecniche:sco:common | | | | |
| type | DatoAN_Type | | | | |
| facets | <table border="0"> <tr> <td>Kind</td> <td>Value</td> </tr> <tr> <td>pattern</td> <td>(([0-9A-Z-])&quot;){1}([0-9A-Z&amp;:] ' - \. / ^ ^\ \\(\) À É È Ì Ò Ù Û &quot; \\N \\+)*</td> </tr> </table> | Kind | Value | pattern | (([0-9A-Z-])"){1}([0-9A-Z&:] ' - \. / ^ ^\ \\(\) À É È Ì Ò Ù Û " \\N \\+)* |
| Kind | Value | | | | |
| pattern | (([0-9A-Z-])"){1}([0-9A-Z&:] ' - \. / ^ ^\ \\(\) À É È Ì Ò Ù Û " \\N \\+)* | | | | |

element Dati_Anagrafici_Type/ProvinciaNascita

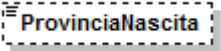
| | |
|-----------|---|
| diagram |  |
| namespace | urn:www.agenziaentrate.gov.it:specificheTecniche:sco:common |
| type | PN_Type |

complexType **Dati_Sottoscrittore_Type**

| | |
|-----------|--|
| diagram | |
| namespace | urn:www.agenziaentrate.gov.it:specificheTecniche:sco:common |
| children | CodiceFiscale CodiceCarica CodiceFiscaleSocieta DatiAnagrafici ResidenzaEstera Telefono DataCarica InizioProcedura ProceduraNonTerminata FineProcedura |

element **Dati_Sottoscrittore_Type/CodiceFiscale**

| diagram | | | | | |
|-----------|---|------|-------|---------|--|
| namespace | urn:www.agenziaentrate.gov.it:specificheTecniche:sco:common | | | | |
| type | DatoCF_Type | | | | |
| facets | <table border="1"> <thead> <tr> <th>Kind</th> <th>Value</th> </tr> </thead> <tbody> <tr> <td>pattern</td> <td>[0-9]{11}[A-Z]{6}[0-9LMNPQRSTUUV]{2}[A-Z]{1}[0-9LMNPQRSTUUV]{2}[A-Z]{1}[0-9LMNPQRSTUUV]{3}[A-Z]{1}</td> </tr> </tbody> </table> | Kind | Value | pattern | [0-9]{11}[A-Z]{6}[0-9LMNPQRSTUUV]{2}[A-Z]{1}[0-9LMNPQRSTUUV]{2}[A-Z]{1}[0-9LMNPQRSTUUV]{3}[A-Z]{1} |
| Kind | Value | | | | |
| pattern | [0-9]{11}[A-Z]{6}[0-9LMNPQRSTUUV]{2}[A-Z]{1}[0-9LMNPQRSTUUV]{2}[A-Z]{1}[0-9LMNPQRSTUUV]{3}[A-Z]{1} | | | | |

element **Dati_Sottoscrittore_Type/CodiceCarica**

| diagram | | | | | | | | | | | | | | | | | | | | | |
|-------------|---|------|-------|---------|----------------|-------------|---|-------------|---|-------------|---|-------------|---|-------------|---|-------------|---|-------------|---|-------------|---|
| namespace | urn:www.agenziaentrate.gov.it:specificheTecniche:sco:common | | | | | | | | | | | | | | | | | | | | |
| type | Codice_Carica_Type | | | | | | | | | | | | | | | | | | | | |
| facets | <table border="1"> <thead> <tr> <th>Kind</th> <th>Value</th> </tr> </thead> <tbody> <tr> <td>pattern</td> <td>[1-9]{1}[0-9]*</td> </tr> <tr> <td>enumeration</td> <td>1</td> </tr> <tr> <td>enumeration</td> <td>2</td> </tr> <tr> <td>enumeration</td> <td>3</td> </tr> <tr> <td>enumeration</td> <td>4</td> </tr> <tr> <td>enumeration</td> <td>5</td> </tr> <tr> <td>enumeration</td> <td>6</td> </tr> <tr> <td>enumeration</td> <td>7</td> </tr> <tr> <td>enumeration</td> <td>8</td> </tr> </tbody> </table> | Kind | Value | pattern | [1-9]{1}[0-9]* | enumeration | 1 | enumeration | 2 | enumeration | 3 | enumeration | 4 | enumeration | 5 | enumeration | 6 | enumeration | 7 | enumeration | 8 |
| Kind | Value | | | | | | | | | | | | | | | | | | | | |
| pattern | [1-9]{1}[0-9]* | | | | | | | | | | | | | | | | | | | | |
| enumeration | 1 | | | | | | | | | | | | | | | | | | | | |
| enumeration | 2 | | | | | | | | | | | | | | | | | | | | |
| enumeration | 3 | | | | | | | | | | | | | | | | | | | | |
| enumeration | 4 | | | | | | | | | | | | | | | | | | | | |
| enumeration | 5 | | | | | | | | | | | | | | | | | | | | |
| enumeration | 6 | | | | | | | | | | | | | | | | | | | | |
| enumeration | 7 | | | | | | | | | | | | | | | | | | | | |
| enumeration | 8 | | | | | | | | | | | | | | | | | | | | |

| | | |
|--|-------------|----|
| | enumeration | 9 |
| | enumeration | 10 |
| | enumeration | 11 |
| | enumeration | 12 |
| | enumeration | 13 |
| | enumeration | 14 |
| | enumeration | 15 |

element Dati_Sottoscrittore_Type/CodiceFiscaleSocieta

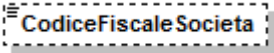
| | |
|-----------|---|
| diagram |  |
| namespace | urn:www.agenziaentrate.gov.it:specificheTecniche:sco:common |
| type | DatoCN Type |
| facets | Kind Value pattern [0-9]{11} |

element Dati_Sottoscrittore_Type/DatiAnagrafici

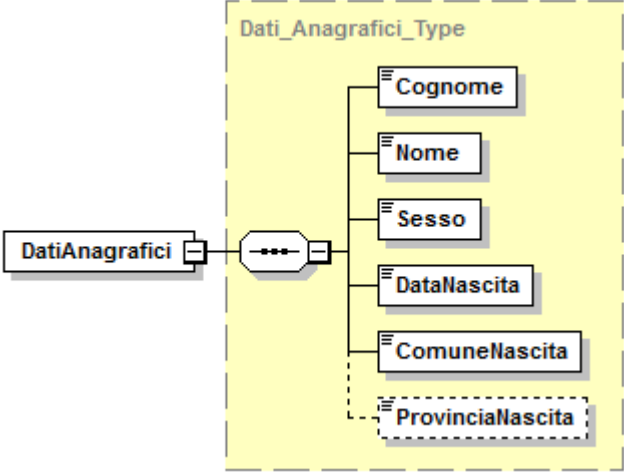
| | |
|-----------|---|
| diagram |  |
| namespace | urn:www.agenziaentrate.gov.it:specificheTecniche:sco:common |
| type | Dati_Anagrafici Type |
| children | Cognome Nome Sesso DataNascita ComuneNascita ProvinciaNascita |

element **Dati_Sottoscrittore_Type/ResidenzaEstera**

| | |
|-----------|--|
| diagram | |
| namespace | urn:www.agenziaentrate.gov.it:specificheTecniche:sco:common |
| type | Residenza_Estera_Type |
| children | CodiceStatoEstero StatoFederato LocalitaEstero IndirizzoEstero |

element **Dati_Sottoscrittore_Type/Telefono**

| | | | | | |
|-----------|---|------|-------|---------|--------|
| diagram | | | | | |
| namespace | urn:www.agenziaentrate.gov.it:specificheTecniche:sco:common | | | | |
| type | DatoTL_Type | | | | |
| facets | <table border="1"> <tr> <td>Kind</td> <td>Value</td> </tr> <tr> <td>pattern</td> <td>[0-9]*</td> </tr> </table> | Kind | Value | pattern | [0-9]* |
| Kind | Value | | | | |
| pattern | [0-9]* | | | | |

element **Dati_Sottoscrittore_Type/DataCarica**

| | | | | | |
|-----------|--|------|-------|---------|---|
| diagram | | | | | |
| namespace | urn:www.agenziaentrate.gov.it:specificheTecniche:sco:common | | | | |
| type | DatoDT_Type | | | | |
| facets | <table border="1"> <tr> <td>Kind</td> <td>Value</td> </tr> <tr> <td>pattern</td> <td>((([0-9]{1,12}[0-9]{3,01})(0[13578][10]12\d{4})) ([0]{1,9}[12][0-9]{30}(0[469][11]\d{4})) ([0]{1,9}[1][0-9]{2[0-8]}(02\d{4})) ((29)(02)[02468][048]00)) ((29)(02)[13579][26]00)) ((29)(02)[0-9][0-9][0][48])) ((29)(02)[0-9][0-9][2468][048])) ((29)(02)[0-9][0-9][13579][26]))</td> </tr> </table> | Kind | Value | pattern | ((([0-9]{1,12}[0-9]{3,01})(0[13578][10]12\d{4})) ([0]{1,9}[12][0-9]{30}(0[469][11]\d{4})) ([0]{1,9}[1][0-9]{2[0-8]}(02\d{4})) ((29)(02)[02468][048]00)) ((29)(02)[13579][26]00)) ((29)(02)[0-9][0-9][0][48])) ((29)(02)[0-9][0-9][2468][048])) ((29)(02)[0-9][0-9][13579][26])) |
| Kind | Value | | | | |
| pattern | ((([0-9]{1,12}[0-9]{3,01})(0[13578][10]12\d{4})) ([0]{1,9}[12][0-9]{30}(0[469][11]\d{4})) ([0]{1,9}[1][0-9]{2[0-8]}(02\d{4})) ((29)(02)[02468][048]00)) ((29)(02)[13579][26]00)) ((29)(02)[0-9][0-9][0][48])) ((29)(02)[0-9][0-9][2468][048])) ((29)(02)[0-9][0-9][13579][26])) | | | | |

element **Dati_Sottoscrittore_Type/InizioProcedura**

| | | | | | |
|-----------|--|------|-------|---------|---|
| diagram | | | | | |
| namespace | urn:www.agenziaentrate.gov.it:specificheTecniche:sco:common | | | | |
| type | DatoDT_Type | | | | |
| facets | <table border="1"> <tr> <td>Kind</td> <td>Value</td> </tr> <tr> <td>pattern</td> <td>((([0-9]{1,12}[0-9]{3,01})(0[13578][10]12\d{4})) ([0]{1,9}[12][0-9]{30}(0[469][11]\d{4})) ([0]{1,9}[1][0-9]{2[0-8]}(02\d{4})) ((29)(02)[02468][048]00)) ((29)(02)[13579][26]00)) ((29)(02)[0-9][0-9][0][48])) ((29)(02)[0-9][0-9][2468][048])) ((29)(02)[0-9][0-9][13579][26]))</td> </tr> </table> | Kind | Value | pattern | ((([0-9]{1,12}[0-9]{3,01})(0[13578][10]12\d{4})) ([0]{1,9}[12][0-9]{30}(0[469][11]\d{4})) ([0]{1,9}[1][0-9]{2[0-8]}(02\d{4})) ((29)(02)[02468][048]00)) ((29)(02)[13579][26]00)) ((29)(02)[0-9][0-9][0][48])) ((29)(02)[0-9][0-9][2468][048])) ((29)(02)[0-9][0-9][13579][26])) |
| Kind | Value | | | | |
| pattern | ((([0-9]{1,12}[0-9]{3,01})(0[13578][10]12\d{4})) ([0]{1,9}[12][0-9]{30}(0[469][11]\d{4})) ([0]{1,9}[1][0-9]{2[0-8]}(02\d{4})) ((29)(02)[02468][048]00)) ((29)(02)[13579][26]00)) ((29)(02)[0-9][0-9][0][48])) ((29)(02)[0-9][0-9][2468][048])) ((29)(02)[0-9][0-9][13579][26])) | | | | |

element Domicilio_EE_Type/Provincia

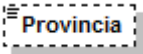
| | |
|-----------|---|
| diagram |  |
| namespace | urn:www.agenziaentrate.gov.it:specificheTecniche:sco:common |
| type | PE_Type |

element Domicilio_EE_Type/CodiceComune

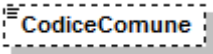
| | |
|-----------|---|
| diagram |  |
| namespace | urn:www.agenziaentrate.gov.it:specificheTecniche:sco:common |
| type | DatoAN_Type |
| facets | Kind Value pattern ([0-9A-Z-]*)"}{1}([0-9A-Z&:] ' - \., / ^ \^\(\\) À É Ê Ï Ò Ù Û " \\ /+)* |

element Domicilio_EE_Type/Indirizzo

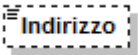
| | |
|-----------|---|
| diagram |  |
| namespace | urn:www.agenziaentrate.gov.it:specificheTecniche:sco:common |
| type | DatoAN_Type |
| facets | Kind Value pattern ([0-9A-Z-]*)"}{1}([0-9A-Z&:] ' - \., / ^ \^\(\\) À É Ê Ï Ò Ù Û " \\ /+)* |

element Domicilio_EE_Type/Cap

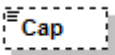
| | |
|-----------|---|
| diagram |  |
| namespace | urn:www.agenziaentrate.gov.it:specificheTecniche:sco:common |
| type | DatoCP_Type |
| facets | Kind Value pattern [0-9]{5} |

element Domicilio_EE_Type/DataVariazione

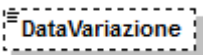
| | |
|-----------|---|
| diagram |  |
| namespace | urn:www.agenziaentrate.gov.it:specificheTecniche:sco:common |
| type | DatoD6_Type |
| facets | Kind Value pattern ((0[0-9]) (1[0-2]))((19 20)[0-9][0-9]) |

complexType **Domicilio_Fiscale_Type**

| | |
|-----------|--|
| diagram | |
| namespace | urn:www.agenziaentrate.gov.it:specificheTecniche:sco:common |
| type | extension of Domicilio_Ita_Type |
| children | Comune Provincia CodiceComune Indirizzo Cap DataVariazione |

element **Domicilio_Fiscale_Type/DataVariazione**

| | | | | | |
|-----------|---|------|-------|---------|--|
| diagram | | | | | |
| namespace | urn:www.agenziaentrate.gov.it:specificheTecniche:sco:common | | | | |
| type | DatoD6_Type | | | | |
| facets | <table border="0"> <tr> <td>Kind</td> <td>Value</td> </tr> <tr> <td>pattern</td> <td>((0[0-9]) (1[0-2]))((19 20)[0-9][0-9])</td> </tr> </table> | Kind | Value | pattern | ((0[0-9]) (1[0-2]))((19 20)[0-9][0-9]) |
| Kind | Value | | | | |
| pattern | ((0[0-9]) (1[0-2]))((19 20)[0-9][0-9]) | | | | |

complexType **Domicilio_Ita_Type**

| | |
|-----------|---|
| diagram | |
| namespace | urn:www.agenziaentrate.gov.it:specificheTecniche:sco:common |
| children | Comune Provincia CodiceComune Indirizzo Cap |

element Domicilio_Ita_Type/Comune

| | |
|-----------|---|
| diagram | |
| namespace | urn:www.agenziaentrate.gov.it:specificheTecniche:sco:common |
| type | DatoAN_Type |
| facets | Kind Value pattern ([0-9A-Z\-\"]{1}([0-9A-Z&#39; \- \., / ^ \^\(\ \)\À É Ê Ë Ì Ò Ù Ü " \ \\ \ +)* |

element Domicilio_Ita_Type/Provincia

| | |
|-----------|---|
| diagram | |
| namespace | urn:www.agenziaentrate.gov.it:specificheTecniche:sco:common |
| type | PR_Type |

element Domicilio_Ita_Type/CodiceComune

| | |
|-----------|---|
| diagram | |
| namespace | urn:www.agenziaentrate.gov.it:specificheTecniche:sco:common |
| type | DatoAN_Type |
| facets | Kind Value pattern ([0-9A-Z\-\"]{1}([0-9A-Z&#39; \- \., / ^ \^\(\ \)\À É Ê Ë Ì Ò Ù Ü " \ \\ \ +)* |

element Domicilio_Ita_Type/Indirizzo

| | |
|-----------|---|
| diagram | |
| namespace | urn:www.agenziaentrate.gov.it:specificheTecniche:sco:common |
| type | DatoAN_Type |
| facets | Kind Value pattern ([0-9A-Z\-\"]{1}([0-9A-Z&#39; \- \., / ^ \^\(\ \)\À É Ê Ë Ì Ò Ù Ü " \ \\ \ +)* |

element Domicilio_Ita_Type/Cap

| | |
|-----------|---|
| diagram | |
| namespace | urn:www.agenziaentrate.gov.it:specificheTecniche:sco:common |
| type | DatoCP_Type |
| facets | Kind Value pattern [0-9]{5} |

complexType Firma_Revisione_Type

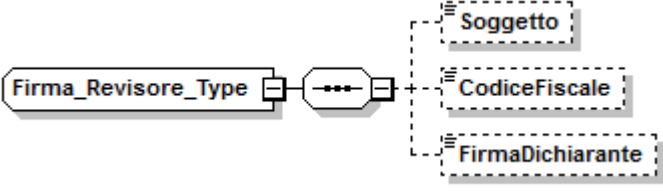
| | |
|-----------|---|
| diagram |  |
| namespace | urn:www.agenziaentrate.gov.it:specificheTecniche:sco:common |
| children | Soggetto CodiceFiscale FirmaDichiarante |

element Firma_Revisione_Type/Soggetto

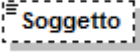
| | |
|-----------|---|
| diagram |  |
| namespace | urn:www.agenziaentrate.gov.it:specificheTecniche:sco:common |
| type | restriction of DatoNP_Type |
| facets | Kind Value pattern [1-4] |

element Firma_Revisione_Type/CodiceFiscale

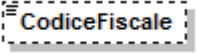
| | |
|-----------|--|
| diagram |  |
| namespace | urn:www.agenziaentrate.gov.it:specificheTecniche:sco:common |
| type | DatoCF_Type |
| facets | Kind Value pattern [0-9]{11}[A-Z]{6}[0-9LMNPQRSTU]{2}[A-Z]{1}[0-9LMNPQRSTU]{2}[A-Z]{1}[0-9LMNPQRSTU]{3}[A-Z]{1} |

element Firma_Revisione_Type/FirmaDichiarante

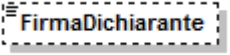
| | |
|-----------|---|
| diagram |  |
| namespace | urn:www.agenziaentrate.gov.it:specificheTecniche:sco:common |
| type | DatoCB_Type |
| facets | Kind Value pattern [01] |

complexType Firma_Type

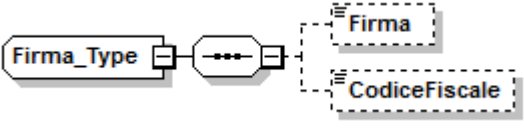
| | |
|-----------|---|
| diagram |  |
| namespace | urn:www.agenziaentrate.gov.it:specificheTecniche:sco:common |

| | |
|----------|-------------------------------------|
| children | Firma CodiceFiscale |
|----------|-------------------------------------|

element Firma_Type/Firma

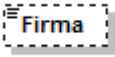
| | |
|-----------|---|
| diagram |  |
| namespace | urn:www.agenziaentrate.gov.it:specificheTecniche:sco:common |
| type | DatoCB_Type |
| facets | Kind Value pattern [01] |

element Firma_Type/CodiceFiscale

| | |
|-----------|---|
| diagram |  |
| namespace | urn:www.agenziaentrate.gov.it:specificheTecniche:sco:common |
| type | restriction of xs:string |
| facets | Kind Value pattern (([0-9A-Z-] \"){0,1}([0-9A-Z&#x26;#x27; \- \., s / \^\ \\ \) À È É Ì Ò Ù Û " \N / +)* |

complexType Frontespizio_Type

| | |
|-----------|---|
| diagram |  |
| namespace | urn:www.agenziaentrate.gov.it:specificheTecniche:sco:common |
| children | SoggettoFiscale |

element Frontespizio_Type/SoggettoFiscale

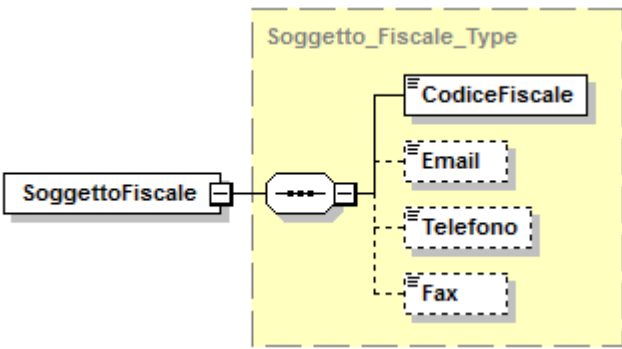
| | |
|-----------|--|
| diagram |  |
| namespace | urn:www.agenziaentrate.gov.it:specificheTecniche:sco:common |
| type | Soggetto Fiscale_Type |
| children | CodiceFiscale Email Telefono Fax |

complexType **Impegno_A_Trasmettere_Type**

| | |
|-----------|---|
| diagram | |
| namespace | urn:www.agenziaentrate.gov.it:specificheTecniche:sco:common |
| children | CFintermediario NumerolscrAlboCAF ImpegnoATrasmettere RicezioneAvvisoTelem DataImpegno FirmaIntermediario |

element **Impegno_A_Trasmettere_Type/CFintermediario**

| diagram | | | | | |
|-----------|--|------|-------|---------|---|
| namespace | urn:www.agenziaentrate.gov.it:specificheTecniche:sco:common | | | | |
| type | DatoCF_Type | | | | |
| facets | <table border="1"> <tr> <th>Kind</th> <th>Value</th> </tr> <tr> <td>pattern</td> <td>[0-9]{11}[A-Z]{6}[0-9LMNPQRSTUW]{2}[A-Z]{1}[0-9LMNPQRSTUW]{2}[A-Z]{1}[0-9LMNPQRSTUW]{3}[A-Z]{1}</td> </tr> </table> | Kind | Value | pattern | [0-9]{11}[A-Z]{6}[0-9LMNPQRSTUW]{2}[A-Z]{1}[0-9LMNPQRSTUW]{2}[A-Z]{1}[0-9LMNPQRSTUW]{3}[A-Z]{1} |
| Kind | Value | | | | |
| pattern | [0-9]{11}[A-Z]{6}[0-9LMNPQRSTUW]{2}[A-Z]{1}[0-9LMNPQRSTUW]{2}[A-Z]{1}[0-9LMNPQRSTUW]{3}[A-Z]{1} | | | | |

element **Impegno_A_Trasmettere_Type/NumerolscrAlboCAF**

| diagram | | | | | |
|-----------|--|------|-------|---------|-----------------------|
| namespace | urn:www.agenziaentrate.gov.it:specificheTecniche:sco:common | | | | |
| type | restriction of DatoNU_Type | | | | |
| facets | <table border="1"> <tr> <th>Kind</th> <th>Value</th> </tr> <tr> <td>pattern</td> <td>(\-[1-9] [1-9])[0-9]*</td> </tr> </table> | Kind | Value | pattern | (\-[1-9] [1-9])[0-9]* |
| Kind | Value | | | | |
| pattern | (\-[1-9] [1-9])[0-9]* | | | | |

element **Impegno_A_Trasmettere_Type/ImpegnoATrasmettere**

| diagram | | | | | | | | | |
|-------------|--|------|-------|---------|-----|-------------|---|-------------|---|
| namespace | urn:www.agenziaentrate.gov.it:specificheTecniche:sco:common | | | | | | | | |
| type | restriction of DatoNP_Type | | | | | | | | |
| facets | <table border="1"> <tr> <th>Kind</th> <th>Value</th> </tr> <tr> <td>pattern</td> <td>1 2</td> </tr> <tr> <td>enumeration</td> <td>1</td> </tr> <tr> <td>enumeration</td> <td>2</td> </tr> </table> | Kind | Value | pattern | 1 2 | enumeration | 1 | enumeration | 2 |
| Kind | Value | | | | | | | | |
| pattern | 1 2 | | | | | | | | |
| enumeration | 1 | | | | | | | | |
| enumeration | 2 | | | | | | | | |

element **Impegno_A_Trasmettere_Type/RicezioneAvvisoTelem**

| | |
|-----------|---|
| diagram | |
| namespace | urn:www.agenziaentrate.gov.it:specificheTecniche:sco:common |
| type | DatoCB_Type |
| facets | Kind Value pattern [01] |

element **Impegno_A_Trasmettere_Type/DatalImpegno**

| | |
|-----------|--|
| diagram | |
| namespace | urn:www.agenziaentrate.gov.it:specificheTecniche:sco:common |
| type | DatoDT_Type |
| facets | Kind Value pattern (((([0-9][12][0-9][3][01])([0-9][13578][10][12](\d{4}))) ((([0-9][1-9][12][0-9][30)([0-9][469][11](\d{4}))) ((([0-9][1-9][1][0-9][2][0-8])([0-9][2](\d{4}))) ((([0-9][2][0-9][048][00]) ((([0-9][2][13579][26][00]) ((([0-9][2][0-9][0-9][0][48]) ((([0-9][2][0-9][0-9][2468][048]) ((([0-9][2][0-9][0-9][13579][26])))))))))))) |

element **Impegno_A_Trasmettere_Type/FirmaIntermediario**

| | |
|-----------|---|
| diagram | |
| namespace | urn:www.agenziaentrate.gov.it:specificheTecniche:sco:common |
| type | DatoCB_Type |
| facets | Kind Value pattern [01] |

complexType **Persone_Fisiche_Type**

| | |
|-----------|--|
| diagram | |
| namespace | urn:www.agenziaentrate.gov.it:specificheTecniche:sco:common |
| children | DatiAnagrafici ResidenzaAnagrafica |

element **Persone_Fisiche_Type/DatiAnagrafici**

| | |
|------------------|--|
| <p>diagram</p> | |
| <p>namespace</p> | <p>urn:www.agenziaentrate.gov.it:specificheTecniche:sco:common</p> |
| <p>type</p> | <p>Dati_Anagrafici_Type</p> |
| <p>children</p> | <p>Cognome Nome Sesso DataNascita ComuneNascita ProvinciaNascita</p> |

element **Persone_Fisiche_Type/ResidenzaAnagrafica**

| | |
|------------------|---|
| <p>diagram</p> | |
| <p>namespace</p> | <p>urn:www.agenziaentrate.gov.it:specificheTecniche:sco:common</p> |
| <p>type</p> | <p>Residenza_Anagrafica_Type</p> |
| <p>children</p> | <p>Comune Provincia CodiceComune Indirizzo Cap DataVariazione</p> |

element Residenza_Estera_Type/CodiceStatoEstero

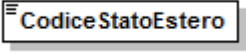
| | |
|-----------|---|
| diagram |  |
| namespace | urn:www.agenziaentrate.gov.it:specificheTecniche:sco:common |
| type | restriction of DatoAN_Type |
| facets | Kind Value pattern ([0-9A-Z\-\] "){1}([0-9A-Z&:] \- \., / ^ \^\(\\)\) À É È Ì Ò Ù Û "; \\ / +)* |

element Residenza_Estera_Type/StatoFederato

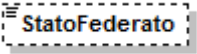
| | |
|-----------|---|
| diagram |  |
| namespace | urn:www.agenziaentrate.gov.it:specificheTecniche:sco:common |
| type | restriction of DatoAN_Type |
| facets | Kind Value pattern ([0-9A-Z\-\] "){1}([0-9A-Z&:] \- \., / ^ \^\(\\)\) À É È Ì Ò Ù Û "; \\ / +)* |

element Residenza_Estera_Type/LocalitaEstero

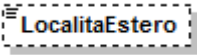
| | |
|-----------|---|
| diagram |  |
| namespace | urn:www.agenziaentrate.gov.it:specificheTecniche:sco:common |
| type | DatoAN_Type |
| facets | Kind Value pattern ([0-9A-Z\-\] "){1}([0-9A-Z&:] \- \., / ^ \^\(\\)\) À É È Ì Ò Ù Û "; \\ / +)* |

element Residenza_Estera_Type/IndirizzoEstero

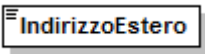
| | |
|-----------|---|
| diagram |  |
| namespace | urn:www.agenziaentrate.gov.it:specificheTecniche:sco:common |
| type | DatoAN_Type |
| facets | Kind Value pattern ([0-9A-Z\-\] "){1}([0-9A-Z&:] \- \., / ^ \^\(\\)\) À É È Ì Ò Ù Û "; \\ / +)* |

complexType **Soggetti_Diversi_Da_PF_Type**

| | |
|------------------|--|
| <p>diagram</p> | |
| <p>namespace</p> | <p>urn:www.agenziaentrate.gov.it:specificheTecniche:sco:common</p> |
| <p>children</p> | <p>Denominazione SedeLegale DomicilioFiscale DataApprovazioneBilancio TermineApprovazioneBilancio InizioPeriodoImposta FinePeriodoImposta Stato NaturaGiuridica Situazione</p> |

element **Soggetti_Diversi_Da_PF_Type/Denominazione**

| | |
|------------------|--|
| <p>diagram</p> | |
| <p>namespace</p> | <p>urn:www.agenziaentrate.gov.it:specificheTecniche:sco:common</p> |
| <p>type</p> | <p>DatoAN_Type</p> |
| <p>facets</p> | <p>Kind Value pattern <code>(([0-9A-Z-] \&quot;){1}([0-9A-Z&amp;#39; ! @ _ ` \.\, / \^\(\)\ À É È Ì Ò Ù Ü &quot; \ \\ / +)*</code></p> |

element **Soggetti_Diversi_Da_PF_Type/SedeLegale**

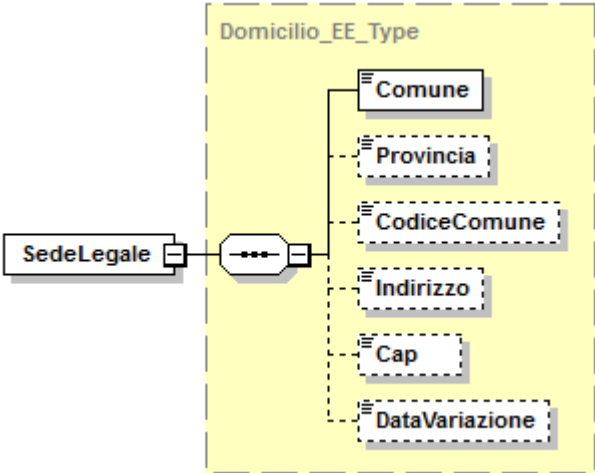
| | |
|------------------|--|
| <p>diagram</p> |  <p>The diagram illustrates the structure of the SedeLegale element. It is connected to a container labeled Domicilio_EE_Type. Inside this container, there are six fields: Comune, Provincia, CodiceComune, Indirizzo, Cap, and DataVariazione. The Comune field is shown as a solid box, while the others are dashed boxes. The SedeLegale element is connected to the container via a line with a small square at the end.</p> |
| <p>namespace</p> | <p>urn:www.agenziaentrate.gov.it:specificheTecniche:sco:common</p> |
| <p>type</p> | <p>Domicilio_EE_Type</p> |
| <p>children</p> | <p>Comune Provincia CodiceComune Indirizzo Cap DataVariazione</p> |

element **Soggetti_Diversi_Da_PF_Type/DomicilioFiscale**

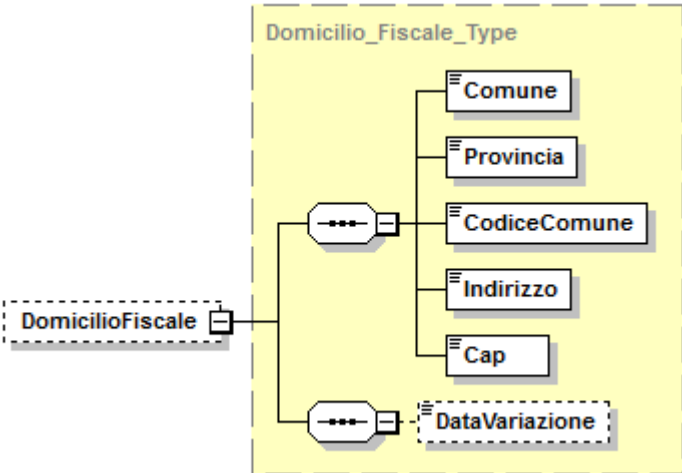
| | |
|------------------|---|
| <p>diagram</p> |  <p>The diagram illustrates the structure of the DomicilioFiscale element. It is connected to a container labeled Domicilio_Fiscale_Type. Inside this container, there are six fields: Comune, Provincia, CodiceComune, Indirizzo, Cap, and DataVariazione. The Comune, Provincia, Indirizzo, and Cap fields are shown as solid boxes, while CodiceComune and DataVariazione are dashed boxes. The DomicilioFiscale element is connected to the container via a line with a small square at the end.</p> |
| <p>namespace</p> | <p>urn:www.agenziaentrate.gov.it:specificheTecniche:sco:common</p> |
| <p>type</p> | <p>Domicilio_Fiscale_Type</p> |
| <p>children</p> | <p>Comune Provincia CodiceComune Indirizzo Cap DataVariazione</p> |

element **Soggetti_Diversi_Da_PF_Type/DataApprovazioneBilancio**

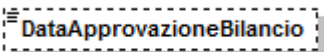
| | |
|------------------|--|
| <p>diagram</p> |  <p>The diagram shows a single dashed box representing the DataApprovazioneBilancio element.</p> |
| <p>namespace</p> | <p>urn:www.agenziaentrate.gov.it:specificheTecniche:sco:common</p> |

| | |
|-------------|---|
| enumeration | 3 |
| enumeration | 4 |

element **Soggetti Diversi Da PF_Type/NaturaGiuridica**

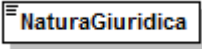
| | | |
|-----------|---|----------------|
| diagram |  | |
| namespace | urn:www.agenziaentrate.gov.it:specificheTecniche:sco:common | |
| type | Natura Giuridica Type | |
| facets | Kind | Value |
| | pattern | [1-9]{1}[0-9]* |
| | enumeration | 1 |
| | enumeration | 2 |
| | enumeration | 3 |
| | enumeration | 4 |
| | enumeration | 5 |
| | enumeration | 6 |
| | enumeration | 7 |
| | enumeration | 8 |
| | enumeration | 9 |
| | enumeration | 10 |
| | enumeration | 11 |
| | enumeration | 12 |
| | enumeration | 13 |
| | enumeration | 14 |
| | enumeration | 15 |
| | enumeration | 16 |
| | enumeration | 17 |
| | enumeration | 18 |
| | enumeration | 19 |
| | enumeration | 20 |
| | enumeration | 21 |
| | enumeration | 22 |
| | enumeration | 23 |
| | enumeration | 24 |
| | enumeration | 25 |
| | enumeration | 26 |
| | enumeration | 27 |
| | enumeration | 28 |
| | enumeration | 29 |
| | enumeration | 30 |
| | enumeration | 31 |
| | enumeration | 32 |
| | enumeration | 33 |
| | enumeration | 34 |
| | enumeration | 35 |
| | enumeration | 36 |
| | enumeration | 37 |
| | enumeration | 38 |
| | enumeration | 39 |
| | enumeration | 40 |
| | enumeration | 41 |
| | enumeration | 42 |
| | enumeration | 43 |
| | enumeration | 44 |
| | enumeration | 45 |
| | enumeration | 50 |
| | enumeration | 51 |
| | enumeration | 52 |
| | enumeration | 53 |
| | enumeration | 54 |
| | enumeration | 55 |
| | enumeration | 56 |
| | enumeration | 57 |

| | |
|-------------|----|
| enumeration | 58 |
| enumeration | 59 |

element **Soggetti Diversi Da PF_Type/Situazione**

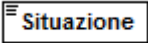
| diagram |  | | | | | | | | | | | | | | | | | | |
|-------------|--|------|-------|---------|----------------|-------------|---|-------------|---|-------------|---|-------------|---|-------------|---|-------------|---|-------------|---|
| namespace | urn:www.agenziaentrate.gov.it:specificheTecniche:sco:common | | | | | | | | | | | | | | | | | | |
| type | Situazione_Type | | | | | | | | | | | | | | | | | | |
| facets | <table border="1"> <thead> <tr> <th>Kind</th> <th>Value</th> </tr> </thead> <tbody> <tr> <td>pattern</td> <td>[1-9]{1}[0-9]*</td> </tr> <tr> <td>enumeration</td> <td>1</td> </tr> <tr> <td>enumeration</td> <td>2</td> </tr> <tr> <td>enumeration</td> <td>3</td> </tr> <tr> <td>enumeration</td> <td>4</td> </tr> <tr> <td>enumeration</td> <td>5</td> </tr> <tr> <td>enumeration</td> <td>6</td> </tr> <tr> <td>enumeration</td> <td>7</td> </tr> </tbody> </table> | Kind | Value | pattern | [1-9]{1}[0-9]* | enumeration | 1 | enumeration | 2 | enumeration | 3 | enumeration | 4 | enumeration | 5 | enumeration | 6 | enumeration | 7 |
| Kind | Value | | | | | | | | | | | | | | | | | | |
| pattern | [1-9]{1}[0-9]* | | | | | | | | | | | | | | | | | | |
| enumeration | 1 | | | | | | | | | | | | | | | | | | |
| enumeration | 2 | | | | | | | | | | | | | | | | | | |
| enumeration | 3 | | | | | | | | | | | | | | | | | | |
| enumeration | 4 | | | | | | | | | | | | | | | | | | |
| enumeration | 5 | | | | | | | | | | | | | | | | | | |
| enumeration | 6 | | | | | | | | | | | | | | | | | | |
| enumeration | 7 | | | | | | | | | | | | | | | | | | |

complexType **Soggetti Non Residenti_Type**

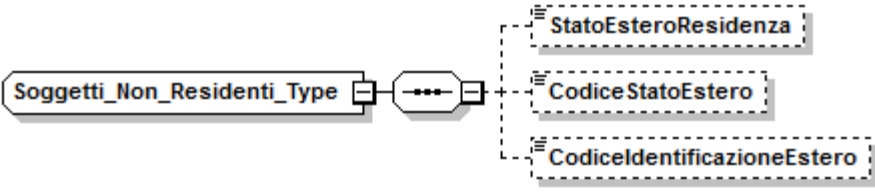
| | |
|-----------|--|
| diagram |  |
| namespace | urn:www.agenziaentrate.gov.it:specificheTecniche:sco:common |
| children | StatoEsteroResidenza CodiceStatoEstero CodiceIdentificazioneEstero |

element **Soggetti Non Residenti_Type/StatoEsteroResidenza**

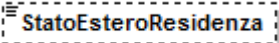
| diagram |  | | | | |
|-----------|---|------|-------|---------|--|
| namespace | urn:www.agenziaentrate.gov.it:specificheTecniche:sco:common | | | | |
| type | DatoAN_Type | | | | |
| facets | <table border="1"> <thead> <tr> <th>Kind</th> <th>Value</th> </tr> </thead> <tbody> <tr> <td>pattern</td> <td>(([0-9A-Z\-\&quot;]{1})([0-9A-Z&amp;] '\- \., /'^\(\)\) À É È Ì Ò Ù Û &quot;; \\ / +)*</td> </tr> </tbody> </table> | Kind | Value | pattern | (([0-9A-Z\-\"]{1})([0-9A-Z&] '\- \., /'^\(\)\) À É È Ì Ò Ù Û "; \\ / +)* |
| Kind | Value | | | | |
| pattern | (([0-9A-Z\-\"]{1})([0-9A-Z&] '\- \., /'^\(\)\) À É È Ì Ò Ù Û "; \\ / +)* | | | | |

element **Soggetti Non Residenti_Type/CodiceStatoEstero**

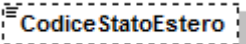
| diagram |  | | | | |
|-----------|---|------|-------|---------|--|
| namespace | urn:www.agenziaentrate.gov.it:specificheTecniche:sco:common | | | | |
| type | DatoAN_Type | | | | |
| facets | <table border="1"> <thead> <tr> <th>Kind</th> <th>Value</th> </tr> </thead> <tbody> <tr> <td>pattern</td> <td>(([0-9A-Z\-\&quot;]{1})([0-9A-Z&amp;] '\- \., /'^\(\)\) À É È Ì Ò Ù Û &quot;; \\ / +)*</td> </tr> </tbody> </table> | Kind | Value | pattern | (([0-9A-Z\-\"]{1})([0-9A-Z&] '\- \., /'^\(\)\) À É È Ì Ò Ù Û "; \\ / +)* |
| Kind | Value | | | | |
| pattern | (([0-9A-Z\-\"]{1})([0-9A-Z&] '\- \., /'^\(\)\) À É È Ì Ò Ù Û "; \\ / +)* | | | | |

element **Soggetti_Non_Residenti_Type/CodiceIdentificazioneEstero**

| diagram | | | | | |
|-----------|---|------|-------|---------|--|
| namespace | urn:www.agenziaentrate.gov.it:specificheTecniche:sco:common | | | | |
| type | DatoAN_Type | | | | |
| facets | <table border="1"> <tr> <th>Kind</th> <th>Value</th> </tr> <tr> <td>pattern</td> <td>([0-9A-Z\-\]&quot;){1}([0-9A-Z&amp;#39; ! - \., / ° °\(\ \)À È É Ì Ò Ù Ú &quot; \ \ /+)*</td> </tr> </table> | Kind | Value | pattern | ([0-9A-Z\-\]"){1}([0-9A-Z&#39; ! - \., / ° °\(\ \)À È É Ì Ò Ù Ú " \ \ /+)* |
| Kind | Value | | | | |
| pattern | ([0-9A-Z\-\]"){1}([0-9A-Z&#39; ! - \., / ° °\(\ \)À È É Ì Ò Ù Ú " \ \ /+)* | | | | |

complexType **Soggetto_Fiscale_Type**

| | |
|-----------|--|
| diagram | |
| namespace | urn:www.agenziaentrate.gov.it:specificheTecniche:sco:common |
| children | CodiceFiscale Email Telefono Fax |

element **Soggetto_Fiscale_Type/CodiceFiscale**

| diagram | | | | | |
|-----------|--|------|-------|---------|---|
| namespace | urn:www.agenziaentrate.gov.it:specificheTecniche:sco:common | | | | |
| type | DatoCF_Type | | | | |
| facets | <table border="1"> <tr> <th>Kind</th> <th>Value</th> </tr> <tr> <td>pattern</td> <td>[0-9]{11}[A-Z]{6}[0-9LMNPQRSTUVWXYZ]{2}[A-Z]{1}[0-9LMNPQRSTUVWXYZ]{2}[A-Z]{1}[0-9LMNPQRSTUVWXYZ]{3}[A-Z]{1}</td> </tr> </table> | Kind | Value | pattern | [0-9]{11}[A-Z]{6}[0-9LMNPQRSTUVWXYZ]{2}[A-Z]{1}[0-9LMNPQRSTUVWXYZ]{2}[A-Z]{1}[0-9LMNPQRSTUVWXYZ]{3}[A-Z]{1} |
| Kind | Value | | | | |
| pattern | [0-9]{11}[A-Z]{6}[0-9LMNPQRSTUVWXYZ]{2}[A-Z]{1}[0-9LMNPQRSTUVWXYZ]{2}[A-Z]{1}[0-9LMNPQRSTUVWXYZ]{3}[A-Z]{1} | | | | |

element **Soggetto_Fiscale_Type/Email**

| diagram | | | | | |
|-----------|--|------|-------|---------|---|
| namespace | urn:www.agenziaentrate.gov.it:specificheTecniche:sco:common | | | | |
| type | DatoEM_Type | | | | |
| facets | <table border="1"> <tr> <th>Kind</th> <th>Value</th> </tr> <tr> <td>pattern</td> <td>[a-zA-Z0-9._%'\-&quot;?^~=]+@[a-zA-Z0-9.\-]+\.[a-zA-Z]{2,4}</td> </tr> </table> | Kind | Value | pattern | [a-zA-Z0-9._%'\-"?^~=]+@[a-zA-Z0-9.\-]+\.[a-zA-Z]{2,4} |
| Kind | Value | | | | |
| pattern | [a-zA-Z0-9._%'\-"?^~=]+@[a-zA-Z0-9.\-]+\.[a-zA-Z]{2,4} | | | | |

element **Soggetto_Fiscale_Type/Telefono**

| | |
|---------|--|
| diagram | |
|---------|--|

| | | |
|-----------|---|--------|
| namespace | urn:www.agenziaentrate.gov.it:specificheTecniche:sco:common | |
| type | DatoTL_Type | |
| facets | Kind | Value |
| | pattern | [0-9]* |

element **Soggetto_Fiscale_Type/Fax**

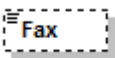
| | | |
|-----------|---|--------|
| diagram |  | |
| namespace | urn:www.agenziaentrate.gov.it:specificheTecniche:sco:common | |
| type | DatoTL_Type | |
| facets | Kind | Value |
| | pattern | [0-9]* |

complexType **Tipo_Dichiarazione_Type**

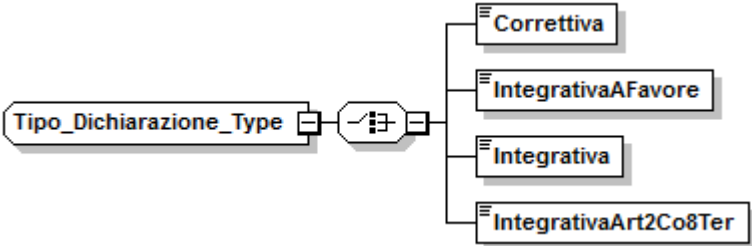
| | | |
|-----------|---|--|
| diagram |  | |
| namespace | urn:www.agenziaentrate.gov.it:specificheTecniche:sco:common | |
| children | Correttiva IntegrativaAFavore Integrativa IntegrativaArt2Co8Ter | |

element **Tipo_Dichiarazione_Type/Correttiva**

| | | |
|-----------|---|-------|
| diagram |  | |
| namespace | urn:www.agenziaentrate.gov.it:specificheTecniche:sco:common | |
| type | DatoCB_Type | |
| facets | Kind | Value |
| | pattern | [01] |

element **Tipo_Dichiarazione_Type/IntegrativaAFavore**

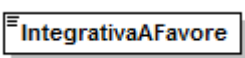
| | | |
|-----------|---|-------|
| diagram |  | |
| namespace | urn:www.agenziaentrate.gov.it:specificheTecniche:sco:common | |
| type | DatoCB_Type | |
| facets | Kind | Value |
| | pattern | [01] |

element Tipo_Dichiarazione_Type/Integrativa

| | |
|-----------|---|
| diagram | |
| namespace | urn:www.agenziaentrate.gov.it:specificheTecniche:sco:common |
| type | DatoCB_Type |
| facets | Kind Value pattern [01] |

element Tipo_Dichiarazione_Type/IntegrativaArt2Co8Ter

| | |
|-----------|---|
| diagram | |
| namespace | urn:www.agenziaentrate.gov.it:specificheTecniche:sco:common |
| type | DatoCB_Type |
| facets | Kind Value pattern [01] |

complexType Visto_Conformita_Type

| | |
|-----------|---|
| diagram | |
| namespace | urn:www.agenziaentrate.gov.it:specificheTecniche:sco:common |
| children | VistoCAF CFprofessionista Firma |

element Visto_Conformita_Type/VistoCAF

| | |
|-----------|---|
| diagram | |
| namespace | urn:www.agenziaentrate.gov.it:specificheTecniche:sco:common |
| children | CFResp CF_CAF |

element Visto_Conformita_Type/VistoCAF/CFResp

| | |
|-----------|---|
| diagram | |
| namespace | urn:www.agenziaentrate.gov.it:specificheTecniche:sco:common |
| type | DatoCF_Type |

| | | |
|--------|-----------------|--|
| facets | Kind pattern | Value [0-9]{11}[A-Z]{6}[0-9LMNPQRSTUW]{2}[A-Z]{1}[0-9LMNPQRSTUW]{2}[A-Z]{1}[0-9LMNPQRSTUW]{3}[A-Z]{1} |
|--------|-----------------|--|

element **Visto_Conformita_Type/VistoCAF/CF_CAF**

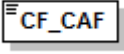
| | | |
|-----------|---|--------------------|
| diagram |  | |
| namespace | urn:www.agenziaentrate.gov.it:specificheTecniche:sco:common | |
| type | DatoCN_Type | |
| facets | Kind pattern | Value [0-9]{11} |

element **Visto_Conformita_Type/CFprofessionista**

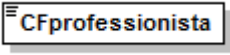
| | | |
|-----------|---|--|
| diagram |  | |
| namespace | urn:www.agenziaentrate.gov.it:specificheTecniche:sco:common | |
| type | DatoCF_Type | |
| facets | Kind pattern | Value [0-9]{11}[A-Z]{6}[0-9LMNPQRSTUW]{2}[A-Z]{1}[0-9LMNPQRSTUW]{2}[A-Z]{1}[0-9LMNPQRSTUW]{3}[A-Z]{1} |

element **Visto_Conformita_Type/Firma**

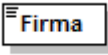
| | | |
|-----------|---|---------------|
| diagram |  | |
| namespace | urn:www.agenziaentrate.gov.it:specificheTecniche:sco:common | |
| type | DatoCB_Type | |
| facets | Kind pattern | Value [01] |

simpleType **Estero**

| | | |
|-----------|---|-------------|
| namespace | urn:www.agenziaentrate.gov.it:specificheTecniche:common | |
| type | restriction of xs:string | |
| facets | Kind enumeration | Value EE |

simpleType **PE_Type**

| | | |
|-----------|--|--|
| namespace | urn:www.agenziaentrate.gov.it:specificheTecniche:common | |
| type | union of (ProvinciItaliane , Estero) | |

simpleType **PN_Type**

| | | |
|-----------|---|--|
| namespace | urn:www.agenziaentrate.gov.it:specificheTecniche:common | |
|-----------|---|--|

| | |
|------|--|
| type | union of (ProvinciItaliane , ProvinciaCroate , Estero) |
|------|--|

simpleType PR_Type

| | |
|-----------|---|
| namespace | urn:www.agenziaentrate.gov.it:specificheTecniche:common |
| type | union of (ProvinciItaliane) |

simpleType ProvinciaCroate

| namespace | urn:www.agenziaentrate.gov.it:specificheTecniche:common | | | | | | | | |
|-------------|---|------|-------|-------------|----|-------------|----|-------------|----|
| type | restriction of xs:string | | | | | | | | |
| facets | <table border="1"> <thead> <tr> <th>Kind</th> <th>Value</th> </tr> </thead> <tbody> <tr> <td>enumeration</td> <td>FU</td> </tr> <tr> <td>enumeration</td> <td>PL</td> </tr> <tr> <td>enumeration</td> <td>ZA</td> </tr> </tbody> </table> | Kind | Value | enumeration | FU | enumeration | PL | enumeration | ZA |
| Kind | Value | | | | | | | | |
| enumeration | FU | | | | | | | | |
| enumeration | PL | | | | | | | | |
| enumeration | ZA | | | | | | | | |

simpleType ProvinciItaliane

| namespace | urn:www.agenziaentrate.gov.it:specificheTecniche:common | | | | | | | | | | | | | | | | | | | | | | | | | | | | | | | | | | | | | | | | | | | | | | | | | | | | | | | | | | | | | | | | | | | | | | | | | | | | | | |
|-------------|---|------|-------|-------------|----|-------------|----|-------------|----|-------------|----|-------------|----|-------------|----|-------------|----|-------------|----|-------------|----|-------------|----|-------------|----|-------------|----|-------------|----|-------------|----|-------------|----|-------------|----|-------------|----|-------------|----|-------------|----|-------------|----|-------------|----|-------------|----|-------------|----|-------------|----|-------------|----|-------------|----|-------------|----|-------------|----|-------------|----|-------------|----|-------------|----|-------------|----|-------------|----|-------------|----|-------------|----|-------------|----|-------------|----|-------------|----|
| type | restriction of xs:string | | | | | | | | | | | | | | | | | | | | | | | | | | | | | | | | | | | | | | | | | | | | | | | | | | | | | | | | | | | | | | | | | | | | | | | | | | | | | | |
| facets | <table border="1"> <thead> <tr> <th>Kind</th> <th>Value</th> </tr> </thead> <tbody> <tr><td>enumeration</td><td>AG</td></tr> <tr><td>enumeration</td><td>AL</td></tr> <tr><td>enumeration</td><td>AN</td></tr> <tr><td>enumeration</td><td>AO</td></tr> <tr><td>enumeration</td><td>AP</td></tr> <tr><td>enumeration</td><td>AQ</td></tr> <tr><td>enumeration</td><td>AR</td></tr> <tr><td>enumeration</td><td>AT</td></tr> <tr><td>enumeration</td><td>AV</td></tr> <tr><td>enumeration</td><td>BA</td></tr> <tr><td>enumeration</td><td>BG</td></tr> <tr><td>enumeration</td><td>BI</td></tr> <tr><td>enumeration</td><td>BL</td></tr> <tr><td>enumeration</td><td>BN</td></tr> <tr><td>enumeration</td><td>BO</td></tr> <tr><td>enumeration</td><td>BR</td></tr> <tr><td>enumeration</td><td>BS</td></tr> <tr><td>enumeration</td><td>BT</td></tr> <tr><td>enumeration</td><td>BZ</td></tr> <tr><td>enumeration</td><td>CA</td></tr> <tr><td>enumeration</td><td>CB</td></tr> <tr><td>enumeration</td><td>CE</td></tr> <tr><td>enumeration</td><td>CH</td></tr> <tr><td>enumeration</td><td>CI</td></tr> <tr><td>enumeration</td><td>CL</td></tr> <tr><td>enumeration</td><td>CN</td></tr> <tr><td>enumeration</td><td>CO</td></tr> <tr><td>enumeration</td><td>CR</td></tr> <tr><td>enumeration</td><td>CS</td></tr> <tr><td>enumeration</td><td>CT</td></tr> <tr><td>enumeration</td><td>CZ</td></tr> <tr><td>enumeration</td><td>EN</td></tr> <tr><td>enumeration</td><td>FC</td></tr> <tr><td>enumeration</td><td>FE</td></tr> <tr><td>enumeration</td><td>FG</td></tr> <tr><td>enumeration</td><td>FI</td></tr> <tr><td>enumeration</td><td>FM</td></tr> <tr><td>enumeration</td><td>FR</td></tr> </tbody> </table> | Kind | Value | enumeration | AG | enumeration | AL | enumeration | AN | enumeration | AO | enumeration | AP | enumeration | AQ | enumeration | AR | enumeration | AT | enumeration | AV | enumeration | BA | enumeration | BG | enumeration | BI | enumeration | BL | enumeration | BN | enumeration | BO | enumeration | BR | enumeration | BS | enumeration | BT | enumeration | BZ | enumeration | CA | enumeration | CB | enumeration | CE | enumeration | CH | enumeration | CI | enumeration | CL | enumeration | CN | enumeration | CO | enumeration | CR | enumeration | CS | enumeration | CT | enumeration | CZ | enumeration | EN | enumeration | FC | enumeration | FE | enumeration | FG | enumeration | FI | enumeration | FM | enumeration | FR |
| Kind | Value | | | | | | | | | | | | | | | | | | | | | | | | | | | | | | | | | | | | | | | | | | | | | | | | | | | | | | | | | | | | | | | | | | | | | | | | | | | | | | |
| enumeration | AG | | | | | | | | | | | | | | | | | | | | | | | | | | | | | | | | | | | | | | | | | | | | | | | | | | | | | | | | | | | | | | | | | | | | | | | | | | | | | | |
| enumeration | AL | | | | | | | | | | | | | | | | | | | | | | | | | | | | | | | | | | | | | | | | | | | | | | | | | | | | | | | | | | | | | | | | | | | | | | | | | | | | | | |
| enumeration | AN | | | | | | | | | | | | | | | | | | | | | | | | | | | | | | | | | | | | | | | | | | | | | | | | | | | | | | | | | | | | | | | | | | | | | | | | | | | | | | |
| enumeration | AO | | | | | | | | | | | | | | | | | | | | | | | | | | | | | | | | | | | | | | | | | | | | | | | | | | | | | | | | | | | | | | | | | | | | | | | | | | | | | | |
| enumeration | AP | | | | | | | | | | | | | | | | | | | | | | | | | | | | | | | | | | | | | | | | | | | | | | | | | | | | | | | | | | | | | | | | | | | | | | | | | | | | | | |
| enumeration | AQ | | | | | | | | | | | | | | | | | | | | | | | | | | | | | | | | | | | | | | | | | | | | | | | | | | | | | | | | | | | | | | | | | | | | | | | | | | | | | | |
| enumeration | AR | | | | | | | | | | | | | | | | | | | | | | | | | | | | | | | | | | | | | | | | | | | | | | | | | | | | | | | | | | | | | | | | | | | | | | | | | | | | | | |
| enumeration | AT | | | | | | | | | | | | | | | | | | | | | | | | | | | | | | | | | | | | | | | | | | | | | | | | | | | | | | | | | | | | | | | | | | | | | | | | | | | | | | |
| enumeration | AV | | | | | | | | | | | | | | | | | | | | | | | | | | | | | | | | | | | | | | | | | | | | | | | | | | | | | | | | | | | | | | | | | | | | | | | | | | | | | | |
| enumeration | BA | | | | | | | | | | | | | | | | | | | | | | | | | | | | | | | | | | | | | | | | | | | | | | | | | | | | | | | | | | | | | | | | | | | | | | | | | | | | | | |
| enumeration | BG | | | | | | | | | | | | | | | | | | | | | | | | | | | | | | | | | | | | | | | | | | | | | | | | | | | | | | | | | | | | | | | | | | | | | | | | | | | | | | |
| enumeration | BI | | | | | | | | | | | | | | | | | | | | | | | | | | | | | | | | | | | | | | | | | | | | | | | | | | | | | | | | | | | | | | | | | | | | | | | | | | | | | | |
| enumeration | BL | | | | | | | | | | | | | | | | | | | | | | | | | | | | | | | | | | | | | | | | | | | | | | | | | | | | | | | | | | | | | | | | | | | | | | | | | | | | | | |
| enumeration | BN | | | | | | | | | | | | | | | | | | | | | | | | | | | | | | | | | | | | | | | | | | | | | | | | | | | | | | | | | | | | | | | | | | | | | | | | | | | | | | |
| enumeration | BO | | | | | | | | | | | | | | | | | | | | | | | | | | | | | | | | | | | | | | | | | | | | | | | | | | | | | | | | | | | | | | | | | | | | | | | | | | | | | | |
| enumeration | BR | | | | | | | | | | | | | | | | | | | | | | | | | | | | | | | | | | | | | | | | | | | | | | | | | | | | | | | | | | | | | | | | | | | | | | | | | | | | | | |
| enumeration | BS | | | | | | | | | | | | | | | | | | | | | | | | | | | | | | | | | | | | | | | | | | | | | | | | | | | | | | | | | | | | | | | | | | | | | | | | | | | | | | |
| enumeration | BT | | | | | | | | | | | | | | | | | | | | | | | | | | | | | | | | | | | | | | | | | | | | | | | | | | | | | | | | | | | | | | | | | | | | | | | | | | | | | | |
| enumeration | BZ | | | | | | | | | | | | | | | | | | | | | | | | | | | | | | | | | | | | | | | | | | | | | | | | | | | | | | | | | | | | | | | | | | | | | | | | | | | | | | |
| enumeration | CA | | | | | | | | | | | | | | | | | | | | | | | | | | | | | | | | | | | | | | | | | | | | | | | | | | | | | | | | | | | | | | | | | | | | | | | | | | | | | | |
| enumeration | CB | | | | | | | | | | | | | | | | | | | | | | | | | | | | | | | | | | | | | | | | | | | | | | | | | | | | | | | | | | | | | | | | | | | | | | | | | | | | | | |
| enumeration | CE | | | | | | | | | | | | | | | | | | | | | | | | | | | | | | | | | | | | | | | | | | | | | | | | | | | | | | | | | | | | | | | | | | | | | | | | | | | | | | |
| enumeration | CH | | | | | | | | | | | | | | | | | | | | | | | | | | | | | | | | | | | | | | | | | | | | | | | | | | | | | | | | | | | | | | | | | | | | | | | | | | | | | | |
| enumeration | CI | | | | | | | | | | | | | | | | | | | | | | | | | | | | | | | | | | | | | | | | | | | | | | | | | | | | | | | | | | | | | | | | | | | | | | | | | | | | | | |
| enumeration | CL | | | | | | | | | | | | | | | | | | | | | | | | | | | | | | | | | | | | | | | | | | | | | | | | | | | | | | | | | | | | | | | | | | | | | | | | | | | | | | |
| enumeration | CN | | | | | | | | | | | | | | | | | | | | | | | | | | | | | | | | | | | | | | | | | | | | | | | | | | | | | | | | | | | | | | | | | | | | | | | | | | | | | | |
| enumeration | CO | | | | | | | | | | | | | | | | | | | | | | | | | | | | | | | | | | | | | | | | | | | | | | | | | | | | | | | | | | | | | | | | | | | | | | | | | | | | | | |
| enumeration | CR | | | | | | | | | | | | | | | | | | | | | | | | | | | | | | | | | | | | | | | | | | | | | | | | | | | | | | | | | | | | | | | | | | | | | | | | | | | | | | |
| enumeration | CS | | | | | | | | | | | | | | | | | | | | | | | | | | | | | | | | | | | | | | | | | | | | | | | | | | | | | | | | | | | | | | | | | | | | | | | | | | | | | | |
| enumeration | CT | | | | | | | | | | | | | | | | | | | | | | | | | | | | | | | | | | | | | | | | | | | | | | | | | | | | | | | | | | | | | | | | | | | | | | | | | | | | | | |
| enumeration | CZ | | | | | | | | | | | | | | | | | | | | | | | | | | | | | | | | | | | | | | | | | | | | | | | | | | | | | | | | | | | | | | | | | | | | | | | | | | | | | | |
| enumeration | EN | | | | | | | | | | | | | | | | | | | | | | | | | | | | | | | | | | | | | | | | | | | | | | | | | | | | | | | | | | | | | | | | | | | | | | | | | | | | | | |
| enumeration | FC | | | | | | | | | | | | | | | | | | | | | | | | | | | | | | | | | | | | | | | | | | | | | | | | | | | | | | | | | | | | | | | | | | | | | | | | | | | | | | |
| enumeration | FE | | | | | | | | | | | | | | | | | | | | | | | | | | | | | | | | | | | | | | | | | | | | | | | | | | | | | | | | | | | | | | | | | | | | | | | | | | | | | | |
| enumeration | FG | | | | | | | | | | | | | | | | | | | | | | | | | | | | | | | | | | | | | | | | | | | | | | | | | | | | | | | | | | | | | | | | | | | | | | | | | | | | | | |
| enumeration | FI | | | | | | | | | | | | | | | | | | | | | | | | | | | | | | | | | | | | | | | | | | | | | | | | | | | | | | | | | | | | | | | | | | | | | | | | | | | | | | |
| enumeration | FM | | | | | | | | | | | | | | | | | | | | | | | | | | | | | | | | | | | | | | | | | | | | | | | | | | | | | | | | | | | | | | | | | | | | | | | | | | | | | | |
| enumeration | FR | | | | | | | | | | | | | | | | | | | | | | | | | | | | | | | | | | | | | | | | | | | | | | | | | | | | | | | | | | | | | | | | | | | | | | | | | | | | | | |

| | |
|-------------|----|
| enumeration | GE |
| enumeration | GO |
| enumeration | GR |
| enumeration | IM |
| enumeration | IS |
| enumeration | KR |
| enumeration | LC |
| enumeration | LE |
| enumeration | LI |
| enumeration | LO |
| enumeration | LT |
| enumeration | LU |
| enumeration | MB |
| enumeration | MC |
| enumeration | ME |
| enumeration | MI |
| enumeration | MN |
| enumeration | MO |
| enumeration | MS |
| enumeration | MT |
| enumeration | NA |
| enumeration | NO |
| enumeration | NU |
| enumeration | OG |
| enumeration | OR |
| enumeration | OT |
| enumeration | PA |
| enumeration | PC |
| enumeration | PD |
| enumeration | PE |
| enumeration | PG |
| enumeration | PI |
| enumeration | PN |
| enumeration | PO |
| enumeration | PR |
| enumeration | PT |
| enumeration | PU |
| enumeration | PV |
| enumeration | PZ |
| enumeration | RA |
| enumeration | RC |
| enumeration | RE |
| enumeration | RG |
| enumeration | RI |
| enumeration | RM |
| enumeration | RN |
| enumeration | RO |
| enumeration | SA |
| enumeration | SI |
| enumeration | SO |
| enumeration | SP |
| enumeration | SR |
| enumeration | SS |
| enumeration | SV |
| enumeration | TA |
| enumeration | TE |
| enumeration | TN |
| enumeration | TO |
| enumeration | TP |
| enumeration | TR |
| enumeration | TS |
| enumeration | TV |
| enumeration | UD |
| enumeration | VA |
| enumeration | VB |
| enumeration | VC |
| enumeration | VE |
| enumeration | VI |
| enumeration | VR |

| | | |
|--|-------------|----|
| | enumeration | VS |
| | enumeration | VT |
| | enumeration | VV |

simpleType Casella_Quadro_Type

| | | |
|-----------|---|--|
| namespace | urn:www.agenziaentrate.gov.it:specificheTecniche:sco:common | |
| type | restriction of DatoAN_Type | |
| facets | Kind | Value |
| | pattern | ([0-9A-Z\-\-] \"){1}([0-9A-Z&] ' \" _ . / ° \" \"() À È É Ì Ò Ù Ü \" \\" / +)* |
| | enumeration | 0 |
| | enumeration | 1 |
| | enumeration | 2 |
| | enumeration | 3 |

simpleType Codice_Carica_Type

| | | |
|-----------|---|----------------|
| namespace | urn:www.agenziaentrate.gov.it:specificheTecniche:sco:common | |
| type | restriction of DatoNP_Type | |
| facets | Kind | Value |
| | pattern | [1-9]{1}[0-9]* |
| | enumeration | 1 |
| | enumeration | 2 |
| | enumeration | 3 |
| | enumeration | 4 |
| | enumeration | 5 |
| | enumeration | 6 |
| | enumeration | 7 |
| | enumeration | 8 |
| | enumeration | 9 |
| | enumeration | 10 |
| | enumeration | 11 |
| | enumeration | 12 |
| | enumeration | 13 |
| | enumeration | 14 |
| | enumeration | 15 |

simpleType Codice_Regione_Type

| | | |
|-----------|---|--|
| namespace | urn:www.agenziaentrate.gov.it:specificheTecniche:sco:common | |
| type | restriction of DatoAN_Type | |
| facets | Kind | Value |
| | pattern | ([0-9A-Z\-\-] \"){1}([0-9A-Z&] ' \" _ . / ° \" \"() À È É Ì Ò Ù Ü \" \\" / +)* |
| | enumeration | 1 |
| | enumeration | 2 |
| | enumeration | 3 |
| | enumeration | 4 |
| | enumeration | 5 |
| | enumeration | 6 |
| | enumeration | 7 |
| | enumeration | 8 |
| | enumeration | 9 |
| | enumeration | 10 |
| | enumeration | 11 |
| | enumeration | 12 |
| | enumeration | 13 |
| | enumeration | 14 |
| | enumeration | 15 |
| | enumeration | 16 |
| | enumeration | 17 |

| | | |
|--|-------------|----|
| | enumeration | 18 |
| | enumeration | 19 |
| | enumeration | 20 |
| | enumeration | 21 |

simpleType **Natura_Giuridica_Type**

| | | |
|-----------|---|----------------|
| namespace | urn:www.agenziaentrate.gov.it:specificheTecniche:sco:common | |
| type | restriction of DatoNP_Type | |
| facets | Kind | Value |
| | pattern | [1-9]{1}[0-9]* |
| | enumeration | 1 |
| | enumeration | 2 |
| | enumeration | 3 |
| | enumeration | 4 |
| | enumeration | 5 |
| | enumeration | 6 |
| | enumeration | 7 |
| | enumeration | 8 |
| | enumeration | 9 |
| | enumeration | 10 |
| | enumeration | 11 |
| | enumeration | 12 |
| | enumeration | 13 |
| | enumeration | 14 |
| | enumeration | 15 |
| | enumeration | 16 |
| | enumeration | 17 |
| | enumeration | 18 |
| | enumeration | 19 |
| | enumeration | 20 |
| | enumeration | 21 |
| | enumeration | 22 |
| | enumeration | 23 |
| | enumeration | 24 |
| | enumeration | 25 |
| | enumeration | 26 |
| | enumeration | 27 |
| | enumeration | 28 |
| | enumeration | 29 |
| | enumeration | 30 |
| | enumeration | 31 |
| | enumeration | 32 |
| | enumeration | 33 |
| | enumeration | 34 |
| | enumeration | 35 |
| | enumeration | 36 |
| | enumeration | 37 |
| | enumeration | 38 |
| | enumeration | 39 |
| | enumeration | 40 |
| | enumeration | 41 |
| | enumeration | 42 |
| | enumeration | 43 |
| | enumeration | 44 |
| | enumeration | 45 |
| | enumeration | 50 |
| | enumeration | 51 |
| | enumeration | 52 |
| | enumeration | 53 |
| | enumeration | 54 |
| | enumeration | 55 |
| | enumeration | 56 |
| | enumeration | 57 |
| | enumeration | 58 |
| | enumeration | 59 |

simpleType Sesso_Type

| | | |
|-----------|---|---|
| namespace | urn:www.agenziaentrate.gov.it:specificheTecniche:sco:common | |
| type | restriction of DatoAN_Type | |
| facets | Kind | Value |
| | pattern | ([0-9A-Z-] "){1}([0-9A-Z&] ' - \. / ° °\^ \(\) À È É Ì Ò Ù Ü ";\ \\ \ +)* |
| | enumeration | M |
| | enumeration | F |

simpleType Situazione_Type

| | | |
|-----------|---|----------------|
| namespace | urn:www.agenziaentrate.gov.it:specificheTecniche:sco:common | |
| type | restriction of DatoNP_Type | |
| facets | Kind | Value |
| | pattern | [1-9]{1}[0-9]* |
| | enumeration | 1 |
| | enumeration | 2 |
| | enumeration | 3 |
| | enumeration | 4 |
| | enumeration | 5 |
| | enumeration | 6 |
| | enumeration | 7 |

simpleType Stato_Type

| | | |
|-----------|---|----------------|
| namespace | urn:www.agenziaentrate.gov.it:specificheTecniche:sco:common | |
| type | restriction of DatoNP_Type | |
| facets | Kind | Value |
| | pattern | [1-9]{1}[0-9]* |
| | enumeration | 1 |
| | enumeration | 2 |
| | enumeration | 3 |
| | enumeration | 4 |

simpleType Eventi_Ecc_Type

| | | |
|-----------|---|-------|
| namespace | urn:www.agenziaentrate.gov.it:specificheTecniche:sco:common | |
| type | restriction of xs:string | |
| facets | Kind | Value |
| | enumeration | 1 |
| | enumeration | 2 |
| | enumeration | 3 |
| | enumeration | 4 |

DESCRIZIONE DEI CODICI RELATIVI ALL'ESITO DELLA RICHIESTA

Di seguito si riporta la tabella contenente i valori che può assumere l'elemento "Stato" presente in "EsitoRichiesta" del file xml di fornitura P7315 con la relativa descrizione.

| DESCRIZIONE DEI CODICI PRESENTI NELLA FORNITURA P7315, RELATIVI ALL'ESITO DELLA RICHIESTA DI MOD. 730 PRECOMPILATI TRAMITE FILE | |
|--|--|
| MODELLO 730 PRECOMPILATO PRESENTE NELLA FORNITURA P7315 | |
| Valori dell'elemento "Stato" presente in "EsitoRichiesta" del file xml di fornitura P7315 | Descrizione |
| 300 | Per il codice fiscale del contribuente è presente il 730 Precompilato con il relativo prospetto di liquidazione |
| 310 | Per il codice fiscale del contribuente è presente il 730 Precompilato ma non è liquidabile |
| MODELLO 730 PRECOMPILATO NON PRESENTE NELLA FORNITURA P7315 | |
| Valori dell'elemento "Stato" presente in "EsitoRichiesta" del file xml di fornitura P7315 | Descrizione |
| 055, 355 | Il codice fiscale del contribuente non è valido |
| 056 | Il codice fiscale del contribuente non è associato ad una persona fisica |
| 057, 357 | Il codice fiscale del contribuente non è utilizzabile in quanto aggiornato in altro codice fiscale (*) |
| 059, 359 | Verificare la situazione anagrafica del contribuente presso un Ufficio dell'Agenzia delle Entrate (**) |
| 064 | Per il codice fiscale del contribuente non risulta presentata alcuna dichiarazione 730/2014 o UnicoPF/2014 |
| 065 | Per il codice fiscale del contribuente non risulta presentata alcuna dichiarazione 730/2014 o UnicoPF/2014 congruente con gli importi indicati nella richiesta |
| 307, 308 | Per il codice fiscale del contribuente il 730 Precompilato non è disponibile. Per le motivazioni consultare il sito di Assistenza https://assistenza730.agenziaentrate.it |
| 058 | Per il codice fiscale del contribuente il 730 Precompilato non è disponibile in quanto per il codice fiscale del contribuente non risulta trasmessa nei termini, dal sostituto d'imposta (soggetto richiedente) all'Agenzia delle entrate, la Certificazione Unica 2015 per redditi di lavoro dipendente |
| Nota (*) Il codice fiscale indicato non è utilizzabile perché è un cosiddetto "omocodice", cioè corrispondente ai dati anagrafici di diverse persone. L'Agenzia delle Entrate ha quindi attribuito un nuovo codice fiscale, differente, a ciascuna di esse. Il nuovo codice fiscale è stato comunicato alle persone interessate ed è quello che va utilizzato. | |
| Nota (**) Nel sistema informativo dell'Agenzia delle Entrate è stata registrata una informazione di avvenuto decesso, associata al codice fiscale indicato. In caso di informazione non corretta, è sempre possibile rivolgersi a un ufficio dell'Agenzia delle Entrate per l'eventuale rettifica. | |

La situazione in cui ad una stessa descrizione corrispondono due distinti codici, nella generalità dei casi, fa riferimento ai diversi momenti nei quali è stata riscontrata l'anomalia (acquisizione della richiesta ovvero predisposizione della fornitura).