

ALLEGATO A
Specifiche tecniche per la trasmissione
telematica Modello 730/2024

INDICE

1	AVVERTENZE GENERALI.....	3
2	Brevi cenni sul linguaggio XML.....	3
3	CONTENUTO DELLA FORNITURA.....	5
3.1	Generalità	5
3.2	Coerenza dei dati della dichiarazione.....	6
3.3	Il trattamento del Codice Fiscale.....	6
3.4	Soggetto che presta l’assistenza fiscale.....	6
4	TRASMISSIONE TELEMATICA DEL MOD. 730-4 DA PARTE DEI CAF, DEL PROFESSIONISTA ABILITATO, DI UNA ASSOCIAZIONE PROFESSIONALE E DEL SOSTITUTO D’IMPOSTA ALL’AGENZIA DELLE ENTRATE	8
4.1	Trasmissione telematica del mod. 730-4: Casi particolari	8
4.2	Dati mod. 730-4 resi disponibili dall’Agenzia delle Entrate ai Sostituti o Intermediari	9
5	Specifiche tecniche in formato XML	10
5.1	Generalità Specifiche tecniche in formato XML.....	10
5.1.1	Messaggio.....	10
5.1.2	Intestazione.....	10
5.1.3	Contenuto	10
5.1.4	Fornitura.....	11
5.1.5	Intestazione.....	11
5.1.6	Documento 730	11
5.2	Comunicazione dati rettificati caf o professionisti (Codice Fornitura “73C24”).....	12
5.3	Specifiche tecniche in formato XML	13

CONTENUTO E CARATTERISTICHE TECNICHE DEI DATI DELLE DICHIARAZIONI DEI REDDITI MODELLO 730/2024 DA INVIARE ALL'AMMINISTRAZIONE FINANZIARIA IN VIA TELEMATICA

1 AVVERTENZE GENERALI

I Sostituti d'imposta, i Centri di Assistenza Fiscale, i professionisti abilitati, le società e gli enti di grandi dimensioni, nonché gli intermediari abilitati, trasmettono i dati delle dichiarazioni dei Mod.730, all'**Agenzia delle Entrate** in via telematica.

Il contenuto e le caratteristiche della fornitura dei dati da trasmettere all'Agenzia delle Entrate in via telematica sono riportati nelle specifiche tecniche di seguito esposte.

Si precisa che una dichiarazione da inviare, i cui dati non sono conformi alle indicazioni delle presenti specifiche tecniche, verrà scartata.

Le modalità per la trasmissione dei dati in via telematica sono stabilite con il decreto del 31 luglio 1998 (pubblicato nella G.U. del 12 agosto 1998, n. 187) e successive modificazioni.

2 Brevi cenni sul linguaggio XML

L'Agenzia delle Entrate ha scelto di adottare, per la definizione della fornitura relativa alle dichiarazioni **730/2024**, il linguaggio XML (eXtensible Markup Language).

L'XML è un metalinguaggio, ossia una “grammatica”, per la definizione di documenti da gestire con strumenti informatici.

Per “grammatica” si intende l'insieme standard di definizioni e di regole sintattiche mediante le quali la struttura logica di un documento viene tradotta in una corrispondente struttura fisica, composta di elementi sintattici chiamati **tag**, ossia sequenze di caratteri delimitate dai segni '<' e '>'.

Concretamente, un file XML è un **file di testo** costituito da diversi **elementi individuati dai tag, ciascuno dei quali identifica un componente logico del documento.**

Gli elementi sono organizzati secondo una struttura gerarchica: ciascun **elemento** può infatti contenere altri elementi (**sottoelementi**) oppure del testo. L'elemento principale della struttura “ad albero” così ottenuta è denominato **radice (root element)**.

Agli **elementi** possono essere associate altre informazioni che ne descrivono le proprietà, tali informazioni sono chiamate **attributi**.

La modellazione della fornitura delle dichiarazioni **730/2024 è stata realizzata prevedendo la radice denominata Messaggio, all'interno della quale sono stati individuati i due sottoelementi Intestazione e Contenuto.**

L'elemento Intestazione espone il codice fiscale del soggetto responsabile dell'invio telematico, l'elemento Contenuto definisce al suo interno una Fornitura astratta che, nel caso del modello **730/2024**, assume le caratteristiche di quella ad esso relativa e descritta nel paragrafo 5. L'elemento Contenuto espone l'attributo `codiceFornitura` che per il suddetto modello deve essere impostato al valore **73024**.

Nel paragrafo 5 vengono fornite ulteriori indicazioni relative agli elementi sopra citati.

La struttura della fornitura xml è descritta, mediante l'**XML Schema**, in uno specifico documento (**schema document**), identificato dall'estensione "**xsd**". Il file XSD (XML Schema Definition) delinea il contenuto della fornitura definendone gli elementi ed evidenziandone attributi e relazioni reciproche.

In particolare, lo **schema** relativo alla fornitura xml identifica tre diverse tipologie di componenti: elementi di significato generale, ossia indipendenti dal tipo di documento contenuto nella fornitura stessa, elementi che rappresentano i componenti logici di una generica dichiarazione ed elementi che costituiscono, più specificamente, la struttura di una dichiarazione Modello 730.

Ciascuna delle suddette tipologie di componenti individua un "dominio di nomi" (**namespace**), un ambito nel quale gli elementi sono univoci ed hanno significato omogeneo.

Concretamente, lo schema relativo alla fornitura 730 si compone di un insieme di documenti `xsd`, associati ai tre diversi namespace, nei quali sono definiti, oltre agli elementi della fornitura, anche i tipi di dati ad essi associati ed alcuni elenchi di codici predefiniti previsti per gli elementi della dichiarazione.

3 CONTENUTO DELLA FORNITURA

3.1 Generalità

La fornitura oggetto della trasmissione telematica deve essere conforme alle specifiche dell'eXtensible Markup Language (XML) 1.0 (raccomandazione WC3 10 febbraio 1998) e deve essere codificata secondo la codifica UTF-8.

Il contenuto della fornitura xml, relativa al Modello 730/2024, deve inoltre soddisfare la sintassi descritta nel file XSD denominato “**fornitura730_2024_v1.xsd**”, allegato al presente documento.

Il suddetto schema definisce la struttura della fornitura xml, delineando gli elementi permessi, i loro attributi, i tipi di dati ad essi associati e la relazione gerarchica tra gli elementi stessi.

La procedura distribuita dall'Agenzia delle Entrate esegue una prima fase di **validazione** della fornitura, ossia di verifica che il file sia conforme allo schema ad esso associato ed una successiva fase di **controllo**, nella quale esamina la correttezza dei dati indicati applicando regole specifiche per ciascun elemento.

L'esito negativo della validazione determina lo scarto dell'intera fornitura.

I diagnostici generati in fase di **controllo** possono avere una diversa gravità a seconda dell'elemento interessato e possono determinare lo scarto della singola dichiarazione o dell'intera fornitura.

3.2 Coerenza dei dati della dichiarazione

Nella “*Circolare per la liquidazione ed il controllo del modello 730/2024*“ trovano esposizione anche le regole che definiscono l'accoglimento o meno della dichiarazione 730/2024 da trasmettere in via telematica all'Agenzia delle Entrate. In particolare sono riportati, oltre a tutti i criteri per la puntuale determinazione delle imposte, anche i criteri di accoglimento della dichiarazione. Tali criteri, sono suddivisi in confermabili e bloccanti. La dichiarazione 730/2024 predisposta con le modalità previste nelle presenti specifiche tecniche XML, deve essere conforme ai criteri sopra citati. La non conformità della dichiarazione ai suddetti criteri, determina il non accoglimento della stessa in sede di trasmissione telematica.

3.3 Il trattamento del Codice Fiscale

I codici fiscali riportati nelle dichiarazioni mod. 730/2024 devono essere formalmente corretti. Si precisa che in sede di accoglimento delle dichiarazioni trasmesse in via telematica, costituirà oggetto di scarto della dichiarazione stessa l'indicazione di un **codice fiscale del contribuente** che, anche se formalmente corretto, non risulti registrato presso l'Anagrafe Tributaria.

Nel caso di omocodia del codice fiscale del contribuente risolta dall'Agenzia delle Entrate con l'attribuzione di un nuovo codice fiscale, l'indicazione in dichiarazione del precedente codice fiscale (omocodice) comporta, in sede di accoglimento delle dichiarazioni trasmesse in via telematica, lo scarto della dichiarazione.

Il codice fiscale del rappresentante deve essere registrato in Anagrafe Tributaria; la non registrazione comporta lo scarto della dichiarazione in fase di accettazione **senza possibilità di conferma della stessa.**

Il codice fiscale del sostituto d'imposta che effettuerà le operazioni di conguaglio deve essere registrato in Anagrafe Tributaria; la non registrazione comporta lo scarto della dichiarazione in fase di accettazione senza possibilità di conferma della stessa.

Anche ciascun codice fiscale indicato nel prospetto dei familiari a carico deve essere registrato in Anagrafe Tributaria; la non registrazione comporta lo scarto della dichiarazione in fase di accettazione senza possibilità di conferma della stessa.

3.4 Soggetto che presta l'assistenza fiscale

L'indicazione del soggetto che ha prestato l'assistenza fiscale con i relativi dati identificativi e l'indicazione della data di consegna del mod. 730/2024 sono obbligatori. Si rimanda alle

istruzioni fornite nella circolare di liquidazione al paragrafo “Dati assistenza fiscale da riportare nel flusso telematico”.

4 TRASMISSIONE TELEMATICA DEL MOD. 730-4 DA PARTE DEI CAF, DEL PROFESSIONISTA ABILITATO, DI UNA ASSOCIAZIONE PROFESSIONALE E DEL SOSTITUTO D'IMPOSTA ALL'AGENZIA DELLE ENTRATE

Il D.M. n. 164 del 1999, prevede che i soggetti che prestano l'assistenza fiscale trasmettano i risultati finali delle dichiarazioni relative al mod. 730 (mod. 730-4) non più direttamente ai sostituti d'imposta ma all'Agenzia delle Entrate la quale provvederà successivamente ad inviarli telematicamente al sostituto d'imposta.

Pertanto, in sede di trasmissione telematica delle dichiarazioni relative al modello 730/2024, i dati relativi al suddetto mod. 730-4 dovranno essere allegati ai dati della dichiarazione mod. 730/2024 da trasmettere in via telematica, anche nel caso di assistenza fiscale prestata dal sostituto d'imposta.

Dal'anno di imposta 2019 anche l'INPS ha aderito al flusso telematico del mod. 730-4 gestito da parte dell'Agenzia delle entrate nel caso di assistenza fiscale prestata da Caf o Professionista abilitato (Provvedimento del direttore dell'Agenzia delle entrate del 21 novembre 2019).

Pertanto, a partire dal modello 730/2020, i Caf ed i professionisti abilitati non dovranno più inviare in via telematica direttamente all'INPS il mod. 730-4, ma provvedere ad allegare tale modello 730-4 al modello 730 da trasmettere in via telematica all'Agenzia delle entrate, utilizzando le stesse modalità già previste per i modelli 730 con sostituto d'imposta diverso da INPS.

In sede di accoglimento delle dichiarazioni trasmesse in via telematica, costituisce oggetto di controllo la coerenza dei dati contenuti nel mod. 730-4 con quelli presenti nel modello 730/2024. Eventuali anomalie riscontrate determinano lo scarto della dichiarazione.

Ai sostituti d'imposta i dati relativi al mod. 730-4 saranno resi disponibili presso la sede telematica comunicata con l'apposito modello di comunicazione trasmesso all'Agenzia delle Entrate

4.1 Trasmissione telematica del mod. 730-4: Casi particolari

Nel caso in cui dalla liquidazione della dichiarazione (mod. 730 ordinario ovvero mod. 730 integrativo), risulti che non ci sia alcun importo da trattenere o da rimborsare a cura del sostituto d'imposta, i dati relativi al mod. 730-4 non devono essere riportati nel tracciato telematico della dichiarazione 730/2024 e deve essere impostato ad "1" l'apposito campo (**FlagAssenzaDati730-4**) previsto nelle presenti specifiche tecniche del modello 730/2024. La non corretta impostazione della suddetta casella determina lo scarto della dichiarazione 730/2024.

Si precisa che nel caso di un **modello 730 rettificativo**, qualora dalla liquidazione della dichiarazione risulti che non ci sia alcun importo da trattenere o da rimborsare a cura del sostituto d'imposta, i dati relativi al mod. 730-4 devono comunque essere riportati nel tracciato telematico della dichiarazione 730/2024. In tal caso risulteranno pertanto compilati i soli dati relativi al soggetto che ha prestato l'assistenza fiscale, al sostituto d'imposta, al contribuente con l'assenza di tutti i dati contabili.

4.2 Dati mod. 730-4 resi disponibili dall’Agenzia delle Entrate ai Sostituti o Intermediari

I dati relativi al mod. 730-4 saranno resi disponibili da parte dell’Agenzia delle Entrate ai sostituti d’imposta ovvero agli intermediari da questi incaricati in conformità alle istruzioni contenute nelle presenti specifiche tecniche relative al mod. 730/2024 nella sezione riferita alla “**Fornitura 730-4**”.

La sintassi della fornitura relativa ai mod. 730-4 è descritta nel file XSD denominato “**fornitura734_2024_v1.xsd**” la cui documentazione è allegata al presente documento.

5 Specifiche tecniche in formato XML

5.1 Generalità Specifiche tecniche in formato XML

5.1.1 Messaggio

Lo schema prevede la definizione di un elemento principale (radice della struttura) denominato **Messaggio**. Esso è un elemento xml di tipo complesso contenente la sequenza ordinata di due sotto-elementi obbligatori **Intestazione** e **Contenuto** dei quali può essere presente una sola occorrenza.

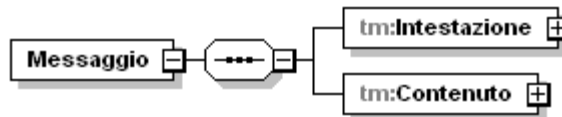

5.1.2 Intestazione

L'elemento xml denominato **Intestazione** è un elemento obbligatorio di tipo complesso **Intestazione_Type** illustrato nella figura seguente.

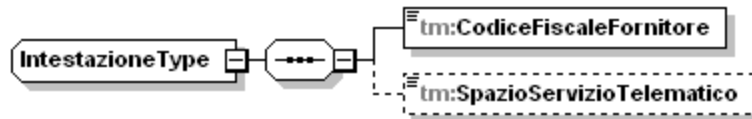

L'elemento **Intestazione** deve contenere i seguenti sottoelementi semplici rispettando la sequenza indicata:

CodiceFiscaleFornitore

È un elemento obbligatorio di tipo semplice che deve esporre il codice fiscale del soggetto responsabile della trasmissione telematica. Il dato è di tipo alfanumerico e può essere composto, in alternativa, o da 11 caratteri numerici (nel caso in cui il codice fiscale si riferisca ad una persona giuridica) oppure da 16 caratteri alfanumerici maiuscoli (nel caso in cui il codice fiscale sia relativo ad una persona fisica).

SpazioServizioTelematico

È un elemento opzionale che deve esporre alcune informazioni riservate al servizio telematico. Tale elemento, pertanto, viene creato esclusivamente da funzionalità predisposte dal servizio telematico. Il dato in esso contenuto è di tipo alfanumerico.

5.1.3 Contenuto

L'elemento xml denominato **Contenuto** deve contenere, al suo interno, i dati identificativi della fornitura ai fini della trasmissione telematica. Pertanto è un elemento di tipo complesso **Contenuto_Type** illustrato nella figura successiva.

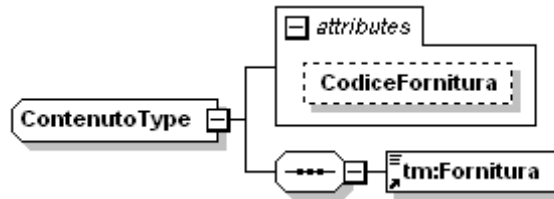

In particolare tale elemento prevede un attributo denominato **CodiceFornitura** ed un sottoelemento **Fornitura**.

L'attributo **CodiceFornitura** identifica il codice della fornitura e serve per individuare in maniera univoca la tipologia di documento contenuto nel file. Tale elemento di tipo semplice è obbligatorio e deve essere composto da 5 caratteri alfanumerici maiuscoli. Per il modello 730/2024 deve assumere il seguente valore “**73024**”.

L'elemento xml denominato **Fornitura**, invece, è un elemento obbligatorio di tipo astratto che deve essere, di volta in volta, implementato dai diversi tipi di fornitura XML.

5.1.4 Fornitura

L'elemento denominato **Fornitura** ed è un elemento xml complesso contenente la sequenza ordinata di due sottoelementi: **Intestazione** e **Documento730**, del quale possono essere presenti una o più occorrenze.

5.1.5 Intestazione

L'elemento Intestazione contiene i dati del soggetto responsabile dell'invio telematico (fornitore):

- TipoFornitore - è l'elemento che definisce la tipologia del soggetto che esegue la trasmissione, è di tipo DatoNP_Type.
- SpazioUtente - è un elemento opzionale il cui contenuto può essere liberamente definito dall'utente ed è di tipo DatoAN_Type

5.1.6 Documento 730

L'elemento Documento 730 è di tipo Documento_730_Type. Il tipo Documento_730_Type definisce l'attributo obbligatorio denominato **identificativo**. Tale attributo ha lo scopo di identificare univocamente il generico documento nell'ambito della fornitura ed è di tipo DatoNP_Type.

Controlli previsti per l'attributo:

Validazione: la lunghezza massima prevista è di 5 caratteri.

Controllo bloccante: il valore assunto dall'attributo deve essere univoco all'interno dell'intera fornitura.

5.2 Comunicazione dati rettificati caf o professionisti (Codice Fornitura “73C24”)

L'articolo 39, comma 1, lettera a), del DLGS n. 241 del 1997, prevede che in caso di visto di conformità infedele su una dichiarazione modello 730, il professionista abilitato, il Responsabile dell'Assistenza Fiscale (RAF) e, in solido con quest'ultimo il CAF sono tenuti al pagamento di un importo pari al 30 per cento della maggiore imposta riscontrata, sempre che il visto infedele non sia stato indotto dalla condotta dolosa o gravemente colposa del contribuente.



La norma stabilisce che il Centro di assistenza fiscale o il professionista può trasmettere una dichiarazione rettificativa del contribuente ovvero, se il contribuente non intende presentare la nuova dichiarazione, può trasmettere una comunicazione dei dati relativi alla rettifica sempreché l'infedeltà del visto non sia già stata contestata con la comunicazione di cui all'articolo 26, comma 3-ter, del decreto del Ministro delle finanze 31 maggio 1999, n. 164.

La trasmissione delle informazioni relative ai dati rettificati deve avvenire con modalità analoghe a quelle previste per la trasmissione telematica dei dati del modello 730/2024 in conformità alle indicazioni fornite nella Circolare di liquidazione del modello 730/2024 ed impostando l'attributo CodiceFornitura al valore “73C24”.

5.3 Specifiche tecniche in formato XML

Di seguito viene descritto il contenuto informativo dei dati della fornitura da trasmettere in via telematica (**fornitura730_2023_v1.xsd** e **fornitura734_2023_v1.xsd**).

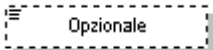
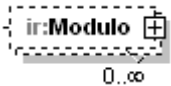
Per la rappresentazione grafica della struttura gerarchica sono utilizzati alcuni simboli grafici descritti nella seguente tabella:

	Elemento obbligatorio
	Elemento opzionale
	Elemento ripetuto 0 o più volte
	Sequenza ordinata di elementi (Sequence)
	Alternativa tra due o più elementi (Choice)

Schema fornitura730_2024_v1.xsd

schema location: **fornitura730_2024_v1.xsd**
attributeFormDefault: **unqualified**
elementFormDefault: **qualified**
targetNamespace: **urn:www.agenziaentrate.gov.it:specificheTecniche:sco:730**

Elements

[Fornitura](#)

schema location: **documento730_2024_v1.xsd**
attributeFormDefault: **unqualified**
elementFormDefault: **qualified**
targetNamespace: **urn:www.agenziaentrate.gov.it:specificheTecniche:sco:730**

Elements

[Documento730](#)

Complex types

[Accounti Altri Dati Type](#)
[Accounti Eccedenze Type](#)
[Accounti Irpef Anno Imposta Type](#)
[Accounti Ritenute Type](#)
[Acoonti Compensati Intern Type](#)
[Acquisto Costruzione Abit Type](#)
[Addizionali Type](#)
[Altre Detrazioni Type](#)
[Altre Ritenute Type](#)
[Altre Spese Type](#)
[Altri Crediti Imposta Type](#)
[Altri Dati Type](#)
[Altri Oneri Type](#)
[Altri Redditi Ass Lav Type](#)
[Altri Redditi Diversi Detr Type](#)
[Altri Redditi Diversi Type](#)
[Altri Redditi Lavoro Autonomo Type](#)
[Altri Redditi Type](#)
[Altri Redditi Utili Type](#)
[Annotazione Type](#)
[Assegno Coniuge Type](#)
[Casella Acconto Type](#)
[Cedolare Secca Type](#)
[Comparto Sicurezza Type](#)
[Compensazione Type](#)
[Comunicazione Amministratore Type](#)
[Conguaglio Sostitutive Type](#)

[Conguaglio Type](#)
[Contributi Previdenza Complementare Type](#)
[Contributo Solidarieta Type](#)
[Cred Erogazione Cultura Type](#)
[Cred Imp Estero Type](#)
[Crediti F24 Type](#)
[Crediti Imposta Altri Sisma Abruzzo Type](#)
[Crediti Imposta Fabbicati Type](#)
[Crediti Imposta Fondi Pensione Type](#)
[Crediti Imposta Redditi Esteri Type](#)
[Crediti Imposta Type](#)
[Credito Ape](#)
[Credito Erogazioni Cultura Type](#)
[Credito Erogazioni Scuola Type](#)
[Credito Immobile Sisma Abruzzo Type](#)
[Credito Incremento Occupazione Type](#)
[Credito Negoziazione Type](#)
[Credito Prima Casa U36](#)
[Credito Stato Type](#)
[Credito Type](#)
[Credito Videosorveglianza Type](#)
[Dati 730 Integrativo Type](#)
[Dati Altre Detrazioni Modulo Type](#)
[Dati Altre Detrazioni Type](#)
[Dati Associazioni Professionale Type](#)
[Dati CAF Type](#)
[Dati Catastali Recupero Patrimonio Edilizio Type](#)
[Dati Catastali Type](#)
[Dati Condominio Type](#)
[Dati Coniuge Type](#)
[Dati Contabili Type](#)
[Dati Contratto Type](#)
[Dati F24 Type](#)
[Dati Familiare Type](#)
[Dati Fornitore Type](#)
[Dati Nascita PF Type](#)
[Dati Primo Figlio Type](#)
[Dati Professionista Type](#)
[Dati Registrazione Accatastamento Recupero Patrimonio Edilizio Type](#)
[Dati Rettificati Type](#)
[Debito Type](#)
[Deduzioni Modulo Type](#)
[Deduzioni Type](#)
[Detrazione Crediti Type](#)
[Detrazioni Canoni Locazione Type](#)
[Detrazioni Modulo Type](#)

[Detrazioni Type](#)
[Dichiarazione Con Type](#)
[Dichiarazione Dich Type](#)
[Documento 730-4](#)
[Documento 730 Type](#)
[Domanda Accatastamento Type](#)
[Domicilio Fiscale Type](#)
[Domicilio Sogg Ass Fiscale Type](#)
[Eccedenze Estero Type](#)
[Eccedenze Oltre Anno Type](#)
[Eccedenze Type](#)
[Elemento Integrativo Type](#)
[Erogazioni Onlus Type](#)
[Esenzione Add Comunale Type](#)
[Esito Liquidazione Type](#)
[Esito Sost Type](#)
[Fabbricato Agev Type](#)
[Fabbricato Ord Type](#)
[Familiari Type](#)
[Firma Dichiarazione Type](#)
[Fondo Pensione Dipendenti Pubblici Type](#)
[Frontespizio 730 Type](#)
[Frontespizio Con Type](#)
[Frontespizio Dich Type](#)
[Fuori Assistenza Type](#)
[Giorni Percentuale Type](#)
[Importi Rimborsare 730-4 Integrativo Type](#)
[Importi Rimborsare 730-4 Type](#)
[Importi Trattenere 730-4 Type](#)
[Importo 730-4](#)
[Imposta Lorda Type](#)
[Imposta Netta Type](#)
[Imposte Rimborsate Type](#)
[Inquilini Abitazione Principale Type](#)
[Intervento Recupero Patrimonio Edilizio Type](#)
[Intervento Risparmio Energetico Type](#)
[Investimenti Estero Type](#)
[Investimento Type](#)
[Iva Acquisto Abitazione Type](#)
[Lavoro Dipendente Type](#)
[Locazioni Brevi Type](#)
[Mance Modulo Type](#)
[Mance Type](#)
[Misura Acconti Type](#)
[Mod730 Integrativo Type](#)
[Modulo Altri Redditi Type](#)

[Modulo Annotazioni Type](#)
[Modulo Comunicazione Type](#)
[Modulo Crediti Imposta Type](#)
[Modulo Credito Negoziazione Type](#)
[Modulo Dati Rettificati Type](#)
[Modulo Fabbricato Type](#)
[Modulo Familiari Type](#)
[Modulo Investimenti Type](#)
[Modulo Lavoro Dip Type](#)
[Modulo Oneri Type](#)
[Modulo PL Type](#)
[Modulo Terreno Type](#)
[Modulo Ulteriori Dati Type](#)
[Oneri Non Abbattuti Type](#)
[Oneri Type](#)
[Opzione Produttivita Type](#)
[Periodo Di Lavoro Type](#)
[Pignoramento Type](#)
[Premi Risultato Modulo Type](#)
[Premi Risultato Type](#)
[Primo Modulo Acconti Ritenute Type](#)
[Primo Modulo Crediti Imposta Type](#)
[Primo Modulo Familiari Type](#)
[Primo Modulo Investimenti Type](#)
[Primo Modulo Lavoro Dip Type](#)
[Primo Modulo Oneri Type](#)
[Primo Modulo PL Type](#)
[Prospetto Annotazioni Type](#)
[Prospetto Liquidazione Type](#)
[Prospetto Type](#)
[Quadro I Type](#)
[Quadro K Type](#)
[Rappresentante Type](#)
[Redditi Capitale Sost Type](#)
[Redditi Capitale Type](#)
[Redditi Eredi Legatari Type](#)
[Redditi Fabbricati Type](#)
[Redditi Lavoro Dip Type](#)
[Redditi Ritenute Spese Type](#)
[Redditi Ritenute Type](#)
[Redditi Tassazione Separata Type](#)
[Redditi Terreni Type](#)
[Reddito Campione Franchi Type](#)
[Reddito Campione Type](#)
[Reddito Erede Type](#)
[Residenza Anagrafica 730 Type](#)

[Residenza Rappresentante Type](#)
[Residenza Type](#)
[Residuo Credito Compens AnnoImposta Type](#)
[Residuo Credito Compens Type](#)
[Residuo Fabbricati Type](#)
[Residuo Onlus Type](#)
[Restituzione Somme Type](#)
[Rettifica Type](#)
[Riduzione Pressione Type](#)
[Riepilogo Redditi Type](#)
[Ritenute Acconti Sospesi Type](#)
[Ritenute Lavoro Dip Type](#)
[Rivalutazione Terreni Type](#)
[Sezione Altri Redd Type](#)
[Sezione Dati Catastali Recupero Patrimonio Edilizio Type](#)
[Soggetto Assistenza Fiscale Doc Type](#)
[Soggetto Fiscale 730 Type](#)
[Soglie Esenzione Type](#)
[Sostituto Type](#)
[Spese Arredo Giovani Coppie Type](#)
[Spese Arredo Type](#)
[Spese Laurea Ricarica Type](#)
[Spese Leasing Type](#)
[Spese Rateizzate Anni Precedenti Type](#)
[Spese Rateizzate Type](#)
[Tassazione Separata Type](#)
[Terreno Type](#)
[Ulteriori Dati Type](#)
[Versamenti F24 Type](#)

schema location: **intestazione730_2024_v1.xsd**
attributeFormDefault: **unqualified**
elementFormDefault: **qualified**
targetNamespace: **urn:www.agenziaentrate.gov.it:specificheTecniche:sco:730**

Elements Complex types
[Intestazione](#) [Intestazione 730 Type](#)

schema location: **types730_2024_v1.xsd**
attributeFormDefault: **unqualified**
elementFormDefault: **qualified**
targetNamespace: **urn:www.agenziaentrate.gov.it:specificheTecniche:sco:730**

Simple types

[Anno Anticipazione Fondo Pensione Type](#)

[Anno Recupero Patrimonio Edilizio Type](#)

[Anno Risparmio Energetico Type](#)

[Casi Particolari Fabbriato Type](#)

[Casi Particolari Risp Ener Type](#)

[Casi Particolari Terreni Type](#)

[Codice Altre Detrazioni Type](#)

[Codice Altre Spese Type](#)

[Codice Altri Oneri Type](#)

[Codice Canone Type](#)

[Codice Evento Eccezionale Type](#)

[Codice Spese Rateizzate Anni Precedenti Type](#)

[Codice Spese Rateizzate Type](#)

[Fabbriato Agev Numero Rigo Type](#)

[Indeterminato Determinato Type](#)

[Integrativo Type](#)

[Mesi Type](#)

[Numero Rata Risparmio Energetico Type](#)

[Periodo Spese Ristrutturazione Type](#)

[Rate10 Type](#)

[Rate Risparmio Energetico Type](#)

[Reintegro Totale Parziale Type](#)

[Rettificativo Type](#)

[Serie Registrazione Contratto Type](#)

[Stato Civile Type](#)

[Terreni Urbano Type](#)

[Tipo Inquilino Type](#)

[Tipo Intervento Type](#)

[Tipo Reddito Da1a3 Type](#)

[Tipo Reddito Da1a4 Type](#)

[Tipo Reddito Da1a8 Type](#)

[Tipologia Soggetto Ass Fisc Type](#)

[Titolo Terreno Type](#)

[Utilizzo Fabbriato Type](#)

schema location:

datiSce_2024_v1.xsd

attributeFormDefault:

unqualified

elementFormDefault:

qualified

targetNamespace:

urn:www.agenziaentrate.gov.it:specificheTecniche:sco:sce

Complex types

[Scelta2PerMille Type](#)

[Scelta2PerMilleAssCult Type](#)

[Scelta5PerMille Type](#)

[Scelta8PerMille Type](#)

[Scelte Type](#)

[Stato Type](#)

element **Fornitura**

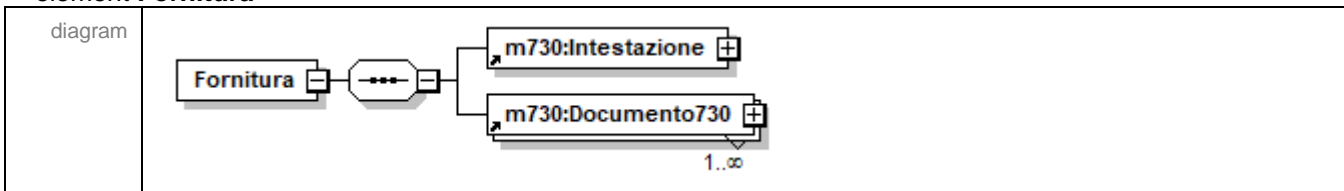

substitution group	tm:Fornitura
children	m730:Intestazione m730:Documento730

element Documento730

diagram					
type	m730:Documento_730_Type				
children	m730:DichiarazioneDich m730:DichiarazioneCon m730:AltriDati m730:Sostituto m730:Mod730DipendentiSenzaSostituto m730:SoggettoAssFiscaleDoc m730:Documento_730-4 m730:EsitiContabili m730:DatiRettificati				
attributes	Name	Type	Use	Default	Fixed
	identificativo	Identificativo_Type	required		

complexType Acconti_Altri_Dati_Type

diagram					
children	m730:IncapientiDetrazioneLocazione m730:Pignoramento ; m730:EccedenzaVersSaldoMance				

element **Acconti_Altri_Dati_Type/IncapientiDetrazioneLocazione**

diagram	
type	DatoNP_Type

element **Acconti_Altri_Dati_Type/Pignoramento**

diagram	
type	m730:Pignoramento_Type
children	m730:TipoRedditoPignoramento m730:RitenutePignoramento

complexType **Acconti_Eccedenze_Type**

diagram	
children	m730:EccedenzaPrecDic m730:EccedenzaCompensata m730:AccontiVersati m730:EccedenzaVersamento

element **Acconti_Eccedenze_Type/EccedenzaPrecDic**

diagram	
type	DatoNP_Type

element **Acconti_Eccedenze_Type/EccedenzaCompensata**

diagram	
type	DatoNP_Type

element **Acconti_Eccedenze_Type/AccontiVersati**

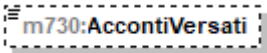
diagram	
type	DatoNP_Type

element **Acconti_Eccedenze_Type/EccedenzaVersamento**

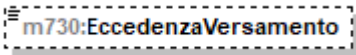
diagram	
type	DatoNP_Type

complexType **Acconti_Irpef_Anno_Imposta_Type**

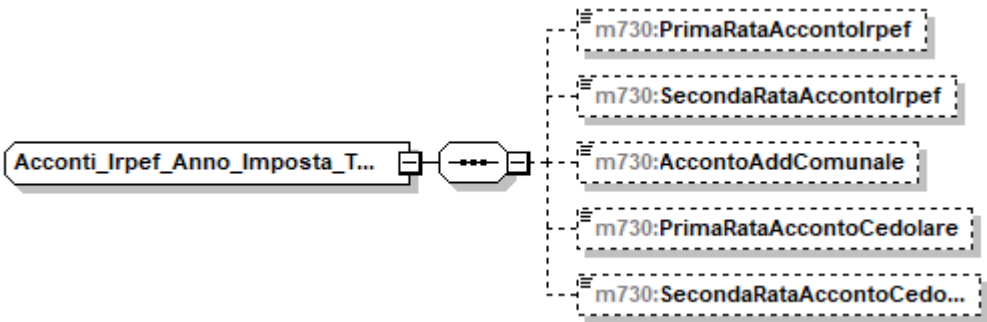
diagram	
children	m730:PrimaRataAccontolrpef m730:SecondaRataAccontolrpef m730:AccontoAddComunale m730:PrimaRataAccontoCedolare m730:SecondaRataAccontoCedolare

element **Acconti_Irpef_Anno_Imposta_Type/PrimaRataAccontolrpef**

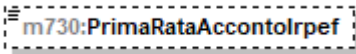
diagram	
type	DatoNP_Type

element **Acconti_Irpef_Anno_Imposta_Type/SecondaRataAccontolrpef**

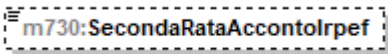
diagram	
type	DatoNP_Type

element **Acconti_Irpef_Anno_Imposta_Type/AccontoAddComunale**

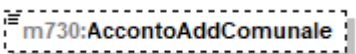
diagram	
type	DatoNP_Type

element **Acconti_Irpef_Anno_Imposta_Type/PrimaRataAccontoCedolare**

diagram	
type	DatoNP_Type

element **Acconti_Irpef_Anno_Imposta_Type/SecondaRataAccontoCedolare**

diagram	
type	DatoNP_Type

complexType **Acconti_Ritenute_Type**

diagram	
children	m730:PrimoModulo m730:Modulo

element **Acconti_Ritenute_Type/PrimoModulo**

diagram	
type	m730:Primo_Modulo_Acconti_Ritenute_Type

children	m730:Accontilrpef m730:AltreRitenute m730:Eccedenze m730:EccedenzeOltreAnno m730:RitenuteAccontiSospesi m730:MisuraAcconti m730:EsenzioneAddComunale m730:Dati730Integrativo m730:AccontiAltriDati m730:LocazioniBrevi
----------	--

element **Acconti_Ritenute_Type/Modulo**

diagram	<pre> classDiagram class m730Modulo["m730:Modulo"] class m730AltreRitenute["m730:AltreRitenute"] class m730EccedenzeOltreAnno["m730:EccedenzeOltreAnno"] class m730Pignoramento["m730:Pignoramento"] m730Modulo "0..∞" -- "*" m730AltreRitenute m730Modulo "0..∞" -- "*" m730EccedenzeOltreAnno m730Modulo "0..∞" -- "*" m730Pignoramento </pre>
children	m730:AltreRitenute m730:EccedenzeOltreAnno m730:Pignoramento

element **Acconti_Ritenute_Type/Modulo/AltreRitenute**

diagram	<pre> classDiagram class m730AltreRitenute["m730:AltreRitenute"] class m730AltreRitenuteType["m730:Altre_Ritenute_Type"] m730AltreRitenute -- m730AltreRitenuteType class m730Codice["m730:Codice"] class m730AltreRitenuteIrpef["m730:AltreRitenuteIrpef"] class m730AddizionaleRegionale["m730:AddizionaleRegionale"] class m730AddizionaleComunale["m730:AddizionaleComunale"] class m730AddRegionaleIrpefAttivita["m730:AddRegionaleIrpefAttivita..."] class m730AddComunaleIrpefAttivita["m730:AddComunaleIrpefAttivita..."] class m730IrpefLavoriSocialmenteUtili["m730:IrpefLavoriSocialmenteUtili"] class m730AddRegionaleIrpefLavoriS["m730:AddRegionaleIrpefLavoriS..."] m730AltreRitenuteType -- m730Codice m730AltreRitenuteType -- m730AltreRitenuteIrpef m730AltreRitenuteType -- m730AddizionaleRegionale m730AltreRitenuteType -- m730AddizionaleComunale m730AltreRitenuteType -- m730AddRegionaleIrpefAttivita m730AltreRitenuteType -- m730AddComunaleIrpefAttivita m730AltreRitenuteType -- m730IrpefLavoriSocialmenteUtili m730AltreRitenuteType -- m730AddRegionaleIrpefLavoriS </pre>
type	m730:Altre_Ritenute_Type
children	m730:Codice m730:AltreRitenuteIrpef m730:AddizionaleRegionale m730:AddizionaleComunale m730:AddRegionaleIrpefAttivitaSport m730:AddComunaleIrpefAttivitaSport m730:IrpefLavoriSocialmenteUtili m730:AddRegionaleIrpefLavoriSoc_Utili

element **Acconti_Ritenute_Type/Modulo/EccedenzeOltreAnno**

diagram	
type	m730:Eccedenze Oltre Anno Type
children	m730:Anno m730:Irpef m730:SostitutivaQuadroRT m730:CedolareSecca m730:CodiceRegione m730:AddRegionaleIrpef m730:CodiceCatastaleComune m730:AddComunaleIrpef m730:ImpostaSostitutiva

element **Acconti_Ritenute_Type/Modulo/Pignoramento**

diagram	
type	m730:Pignoramento Type
children	m730:TipoRedditoPignoramento m730:RitenutePignoramento

complexType **Acoonti_Compensati_Intern_Type**

diagram	
children	m730:PrimaRatalrpef m730:AddizionaleComunale m730:PrimaRataCedolare

element **Acoonti_Compensati_Intern_Type/PrimaRatalrpef**

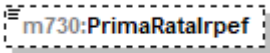
diagram	
type	DatoNP_Type

element **Acoonti_Compensati_Intern_Type/AddizionaleComunale**

diagram	
type	DatoNP_Type

element **Acoonti_Compensati_Intern_Type/PrimaRataCedolare**

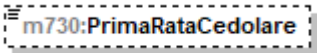
diagram	
type	DatoNP_Type

complexType **Acquisto_Costruzione_Abit_Type**

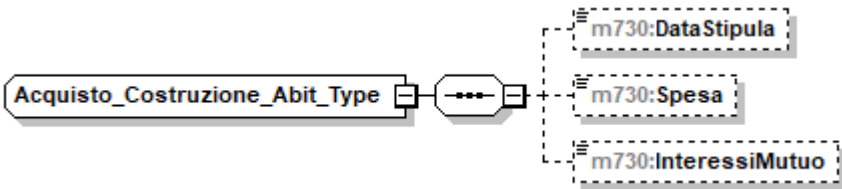
diagram	
children	m730:DataStipula m730:Spesa m730:InteressiMutuo

element **Acquisto_Costruzione_Abit_Type/DataStipula**

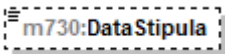
diagram	
type	DatoDT_Type

element **Acquisto_Costruzione_Abit_Type/Spesa**

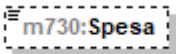
diagram	
type	DatoNP_Type

element **Acquisto_Costruzione_Abit_Type/InteressiMutuo**

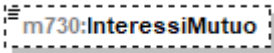
diagram	
type	DatoNP_Type

complexType **Addizionali_Type**

diagram	
children	m730:Imponibile m730:AddRegDovuta m730:AddRegCertif m730:EccedenzaAddReg m730:AddComDovuta m730:AddComCertif m730:EccedenzaAddCom m730:AccontoAddCom m730:AccontoAddComCertif

element **Addizionali_Type/Imponibile**

diagram	
type	DatoNP_Type

element **Addizionali_Type/AddRegDovuta**

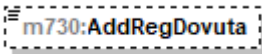
diagram	
type	DatoNP_Type

element **Addizionali_Type/AddRegCertif**

diagram	
type	DatoNP_Type

element **Addizionali_Type/EccedenzaAddReg**

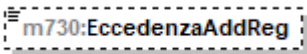
diagram	
type	DatoNU_Type

element **Addizionali_Type/AddComDovuta**

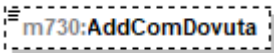
diagram	
type	DatoNP_Type

element **Addizionali_Type/AddComCertif**

diagram	
type	DatoNP_Type

element **Addizionali_Type/EccedenzaAddCom**

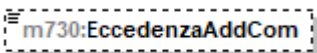
diagram	
type	DatoNU_Type

element **Addizionali_Type/AccontoAddCom**

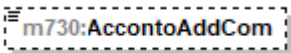
diagram	
type	DatoNP_Type

element **Addizionali_Type/AccontoAddComCertif**

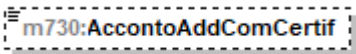
diagram	
type	DatoNP_Type

complexType **Altre_Detrazioni_Type**

diagram	
children	m730:Codice m730:Importo

element **Altre_Detrazioni_Type/Codice**

diagram							
type	m730:Codice Altre_Detrazioni_Type						
facets	<table border="1"> <thead> <tr> <th>Kind</th> <th>Value</th> </tr> </thead> <tbody> <tr> <td>enumeration</td> <td>1</td> </tr> <tr> <td>enumeration</td> <td>2</td> </tr> </tbody> </table>	Kind	Value	enumeration	1	enumeration	2
Kind	Value						
enumeration	1						
enumeration	2						

element **Altre_Detrazioni_Type/Importo**

diagram	
type	DatoNP_Type

complexType **Altre_Ritenute_Type**

diagram	
children	m730:Codice m730:AltreRitenuteIrpef m730:AddizionaleRegionale m730:AddizionaleComunale m730:AddRegionaleIrpefAttivitaSport m730:AddComunaleIrpefAttivitaSport m730:IrpefLavoriSocialmenteUtili m730:AddRegionaleIrpefLavoriSoc_Utili

element **Altre_Ritenute_Type/Codice**

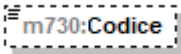
diagram							
type	restriction of DatoN1_Type						
facets	<table border="1"> <thead> <tr> <th>Kind</th> <th>Value</th> </tr> </thead> <tbody> <tr> <td>enumeration</td> <td>1</td> </tr> <tr> <td>enumeration</td> <td>2</td> </tr> </tbody> </table>	Kind	Value	enumeration	1	enumeration	2
Kind	Value						
enumeration	1						
enumeration	2						

element **Altre_Ritenute_Type/AltreRitenuteIrpef**

diagram	
type	DatoNP_Type

element **Altre_Ritenute_Type/AddizionaleRegionale**

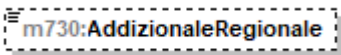
diagram	
type	DatoNP_Type

element **Altre_Ritenute_Type/AddizionaleComunale**

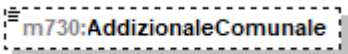
diagram	
type	DatoNP_Type

element **Altre_Ritenute_Type/AddRegionaleIrpefAttivitaSport**

diagram	
type	DatoNP_Type

element **Altre_Ritenute_Type/AddComunaleIrpefAttivitaSport**

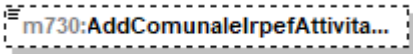
diagram	
type	DatoNP_Type

element **Altre_Ritenute_Type/IrpefLavoriSocialmenteUtili**

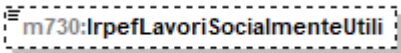
diagram	
type	DatoNP_Type

element **Altre_Ritenute_Type/AddRegionaleIrpefLavoriSoc_Utili**

diagram	
type	DatoNP_Type

complexType **Altre_Spese_Type**

diagram	
children	m730:Codice m730:Importo

element **Altre_Spese_Type/Codice**

diagram																																																																											
type	restriction of m730:Codice Altre_Spese_Type																																																																										
facets	<table border="1"> <thead> <tr> <th>Kind</th> <th>Value</th> </tr> </thead> <tbody> <tr><td>enumeration</td><td>8</td></tr> <tr><td>enumeration</td><td>9</td></tr> <tr><td>enumeration</td><td>10</td></tr> <tr><td>enumeration</td><td>11</td></tr> <tr><td>enumeration</td><td>12</td></tr> <tr><td>enumeration</td><td>13</td></tr> <tr><td>enumeration</td><td>14</td></tr> <tr><td>enumeration</td><td>15</td></tr> <tr><td>enumeration</td><td>16</td></tr> <tr><td>enumeration</td><td>17</td></tr> <tr><td>enumeration</td><td>18</td></tr> <tr><td>enumeration</td><td>20</td></tr> <tr><td>enumeration</td><td>21</td></tr> <tr><td>enumeration</td><td>22</td></tr> <tr><td>enumeration</td><td>24</td></tr> <tr><td>enumeration</td><td>25</td></tr> <tr><td>enumeration</td><td>26</td></tr> <tr><td>enumeration</td><td>27</td></tr> <tr><td>enumeration</td><td>28</td></tr> <tr><td>enumeration</td><td>29</td></tr> <tr><td>enumeration</td><td>30</td></tr> <tr><td>enumeration</td><td>31</td></tr> <tr><td>enumeration</td><td>32</td></tr> <tr><td>enumeration</td><td>33</td></tr> <tr><td>enumeration</td><td>35</td></tr> <tr><td>enumeration</td><td>36</td></tr> <tr><td>enumeration</td><td>38</td></tr> <tr><td>enumeration</td><td>39</td></tr> <tr><td>enumeration</td><td>40</td></tr> <tr><td>enumeration</td><td>43</td></tr> <tr><td>enumeration</td><td>44</td></tr> <tr><td>enumeration</td><td>45</td></tr> <tr><td>enumeration</td><td>46</td></tr> <tr><td>enumeration</td><td>47</td></tr> <tr><td>enumeration</td><td>61</td></tr> <tr><td>enumeration</td><td>62</td></tr> </tbody> </table>	Kind	Value	enumeration	8	enumeration	9	enumeration	10	enumeration	11	enumeration	12	enumeration	13	enumeration	14	enumeration	15	enumeration	16	enumeration	17	enumeration	18	enumeration	20	enumeration	21	enumeration	22	enumeration	24	enumeration	25	enumeration	26	enumeration	27	enumeration	28	enumeration	29	enumeration	30	enumeration	31	enumeration	32	enumeration	33	enumeration	35	enumeration	36	enumeration	38	enumeration	39	enumeration	40	enumeration	43	enumeration	44	enumeration	45	enumeration	46	enumeration	47	enumeration	61	enumeration	62
Kind	Value																																																																										
enumeration	8																																																																										
enumeration	9																																																																										
enumeration	10																																																																										
enumeration	11																																																																										
enumeration	12																																																																										
enumeration	13																																																																										
enumeration	14																																																																										
enumeration	15																																																																										
enumeration	16																																																																										
enumeration	17																																																																										
enumeration	18																																																																										
enumeration	20																																																																										
enumeration	21																																																																										
enumeration	22																																																																										
enumeration	24																																																																										
enumeration	25																																																																										
enumeration	26																																																																										
enumeration	27																																																																										
enumeration	28																																																																										
enumeration	29																																																																										
enumeration	30																																																																										
enumeration	31																																																																										
enumeration	32																																																																										
enumeration	33																																																																										
enumeration	35																																																																										
enumeration	36																																																																										
enumeration	38																																																																										
enumeration	39																																																																										
enumeration	40																																																																										
enumeration	43																																																																										
enumeration	44																																																																										
enumeration	45																																																																										
enumeration	46																																																																										
enumeration	47																																																																										
enumeration	61																																																																										
enumeration	62																																																																										

	enumeration	71
	enumeration	76
	enumeration	81
	enumeration	99

element **Altre_Spese_Type/Importo**

diagram	
type	DatoNP_Type

complexType **Altri_Crediti_Imposta_Type**

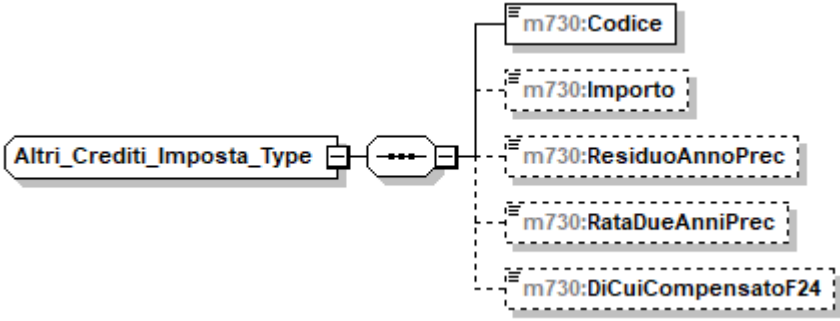
diagram	
children	m730:Codice m730:Importo m730:ResiduoAnnoPrec m730:RataDueAnniPrec m730:DiCuiCompensatoF24

element **Altri_Crediti_Imposta_Type/Codice**

diagram	
type	restriction of DatoNP_Type

element **Altri_Crediti_Imposta_Type/Importo**

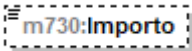
diagram	
type	restriction of DatoNP_Type

element **Altri_Crediti_Imposta_Type/ResiduoAnnoPrec**

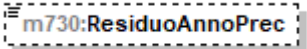
diagram	
type	restriction of DatoNP_Type

element **Altri_Crediti_Imposta_Type/RataDueAnniPrec**

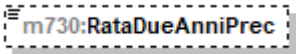
diagram	
type	restriction of DatoNP_Type

element **Altri_Crediti_Imposta_Type/DiCuiCompensatoF24**

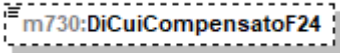
diagram	
type	restriction of DatoNP_Type

complexType Altri_Dati_Type

diagram

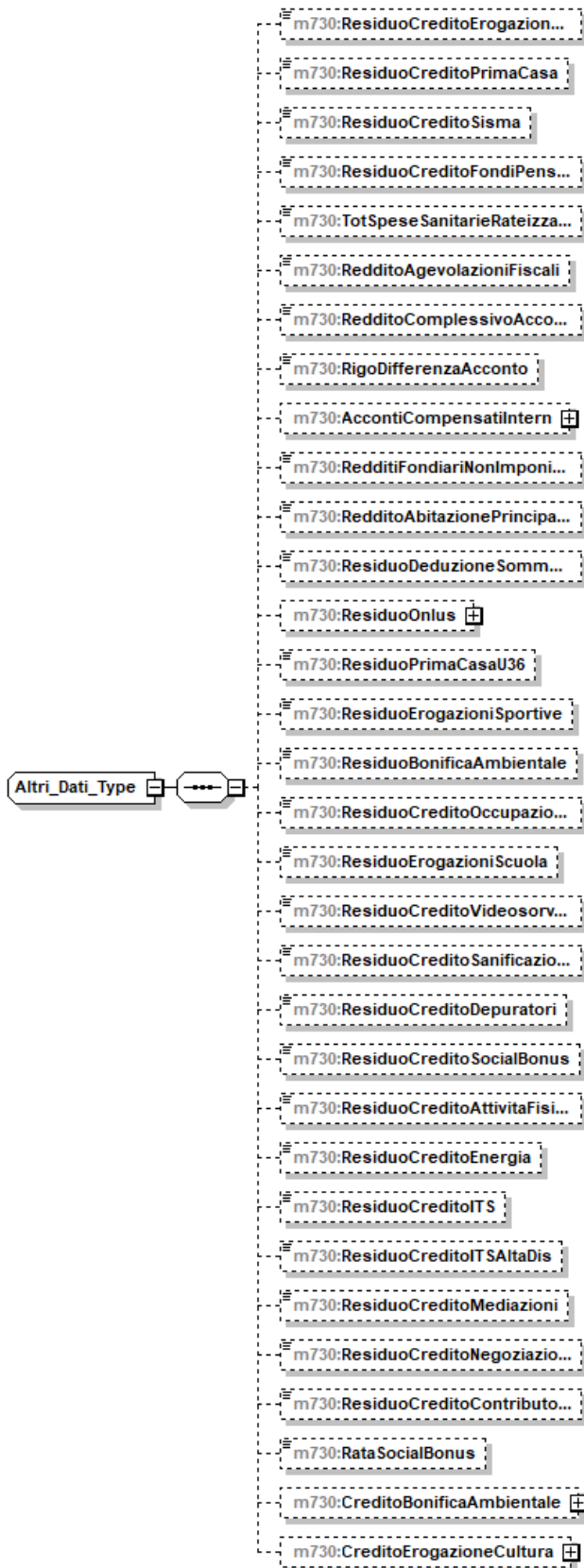

children	m730:ResiduoCreditoErogazioneCultura m730:ResiduoCreditoPrimaCasa m730:ResiduoCreditoSisma m730:ResiduoCreditoFondiPensione m730:TotSpeseSanitarieRateizzate m730:RedditoAgevolazioniFiscali m730:RedditoComplessivoAcconto m730:RigoDifferenzaAcconto m730:AccontiCompensatiIntern m730:RedditiFondiariniNonImponibili m730:RedditoAbitazionePrincipalePertinenze m730:ResiduoDeduzioneSommeRestituite m730:ResiduoOnlus m730:ResiduoPrimaCasaU36 m730:ResiduoErogazioniSportive m730:ResiduoBonificaAmbientale m730:ResiduoCreditoOccupazione m730:ResiduoErogazioniScuola m730:ResiduoCreditoVideosorveglianza m730:ResiduoCreditoSanificazione m730:ResiduoCreditoDepuratori m730:ResiduoCreditoSocialBonus m730:ResiduoCreditoAttivitaFisica m730:ResiduoCreditoEnergia m730:ResiduoCreditoITS m730:ResiduoCreditoITSAltaDis m730:ResiduoCreditoMediazioni m730:ResiduoCreditoNegoziazione m730:ResiduoCreditoContributoUnif m730:RataSocialBonus m730:CreditoBonificaAmbientale m730:CreditoErogazioneCultura
----------	---

element **Altri_Dati_Type/ResiduoCreditoErogazioneCultura**

diagram	
type	DatoNP_Type

element **Altri_Dati_Type/ResiduoCreditoPrimaCasa**

diagram	
type	DatoNP_Type

element **Altri_Dati_Type/ResiduoCreditoSisma**

diagram	
type	DatoNP_Type

element **Altri_Dati_Type/ResiduoCreditoFondiPensione**

diagram	
type	DatoNP_Type

element **Altri_Dati_Type/TotSpeseSanitarieRateizzate**

diagram	
type	DatoNP_Type

element **Altri_Dati_Type/RedditoAgevolazioniFiscali**

diagram	
---------	--

type	DatoNP_Type
------	-----------------------------

element **Altri_Dati_Type/RedditoComplessivoAcconto**

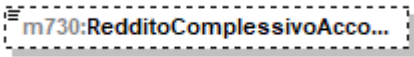
diagram	
type	DatoNP_Type

element **Altri_Dati_Type/RigoDifferenzaAcconto**

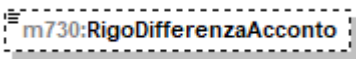
diagram	
type	DatoNU_Type

element **Altri_Dati_Type/AccontiCompensatiIntern**

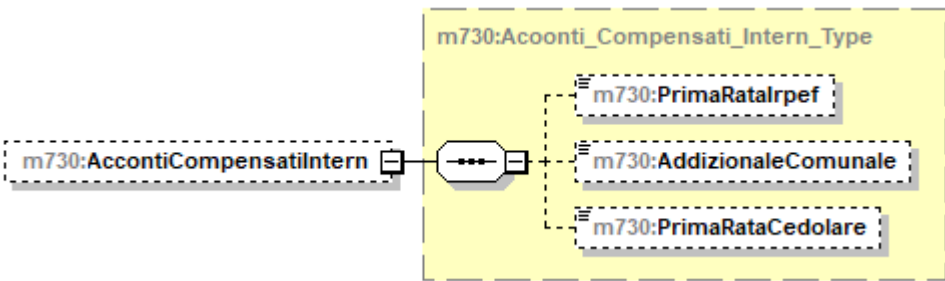
diagram	
type	m730:Acoonti_Compensati_Intern_Type
children	m730:PrimaRatalrpef m730:AddizionaleComunale m730:PrimaRataCedolare

element **Altri_Dati_Type/RedditiFondariNonImponibili**

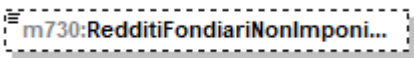
diagram	
type	DatoNP_Type

element **Altri_Dati_Type/RedditoAbitazionePrincipalePertinenze**

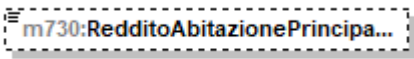
diagram	
type	DatoNP_Type

element **Altri_Dati_Type/ResiduoDeduzioneSommeRestituite**

diagram	
type	DatoNP_Type

element **Altri_Dati_Type/ResiduoOnlus**

diagram	
type	m730:Residuo_Onlus_Type
children	m730:ResiduoTreAnniPrec m730:ResiduoDueAnniPrec m730:ResiduoAnnoPrec m730:ResiduoAnno

element **Altri_Dati_Type/ResiduoPrimaCasaU36**

diagram	
type	DatoNP_Type

element **Altri_Dati_Type/ResiduoErogazioniSportive**

diagram	
type	DatoNP_Type

element **Altri_Dati_Type/ResiduoBonificaAmbientale**

diagram	
type	DatoNP_Type

element **Altri_Dati_Type/ResiduoCreditoOccupazione**

diagram	
type	DatoNP_Type

element **Altri_Dati_Type/ResiduoErogazioniScuola**

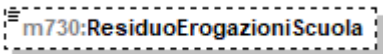
diagram	
type	DatoNP_Type

element **Altri_Dati_Type/ResiduoCreditoVideosorveglianza**

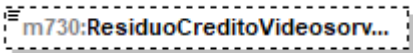
diagram	
type	DatoNP_Type

element **Altri_Dati_Type/ResiduoCreditoSanificazione**

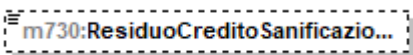
diagram	
type	DatoNP_Type

element **Altri_Dati_Type/ResiduoCreditoDepuratori**

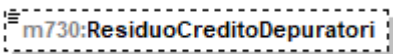
diagram	
type	DatoNP_Type

element **Altri_Dati_Type/ResiduoCreditoSocialBonus**

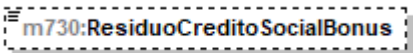
diagram	
type	DatoNP_Type

element **Altri_Dati_Type/ResiduoCreditoAttivitaFisica**

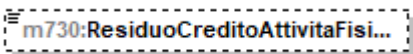
diagram	
type	DatoNP_Type

element **Altri_Dati_Type/ResiduoCreditoEnergia**

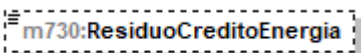
diagram	
type	DatoNP_Type

element **Altri_Dati_Type/ResiduoCreditoITS**

diagram	 m730:ResiduoCreditoITS
type	DatoNP_Type

element **Altri_Dati_Type/ResiduoCreditoITSAItaDis**

diagram	 m730:ResiduoCreditoITSAItaDis
type	DatoNP_Type

element **Altri_Dati_Type/ResiduoCreditoMediazioni**

diagram	 m730:ResiduoCreditoMediazioni
type	DatoNP_Type

element **Altri_Dati_Type/ResiduoCreditoNegoziazione**

diagram	 m730:ResiduoCreditoNegoziazio...
type	DatoNP_Type

element **Altri_Dati_Type/ResiduoCreditoContributoUnif**

diagram	 m730:ResiduoCreditoContributo...
type	DatoNP_Type

element **Altri_Dati_Type/RataSocialBonus**

diagram	 m730:RataSocialBonus
type	DatoNP_Type

element **Altri_Dati_Type/CreditoBonificaAmbientale**

diagram	<p>The diagram shows a dashed box labeled 'm730:CreditoBonificaAmbientale' connected to a central octagonal connector. This connector is linked to a larger dashed box labeled 'm730:Cred_Erogazione_Cultura_Type'. Inside this larger box, there are two smaller dashed boxes: 'm730:RataAnnoPrec' and 'm730:RataAnno'.</p>
type	m730:Cred_Erogazione_Cultura_Type
children	m730:RataAnnoPrec m730:RataAnno

element **Altri_Dati_Type/CreditoErogazioneCultura**

diagram	<p>The diagram shows a dashed box labeled 'm730:CreditoErogazioneCultura' connected to a central octagonal connector. This connector is linked to a larger dashed box labeled 'm730:Cred_Erogazione_Cultura_Type'. Inside this larger box, there are two smaller dashed boxes: 'm730:RataAnnoPrec' and 'm730:RataAnno'.</p>
type	m730:Cred_Erogazione_Cultura_Type
children	m730:RataAnnoPrec m730:RataAnno

complexType **Altri_Oneri_Type**

diagram	<p>The diagram shows a box labeled 'Altri_Oneri_Type' connected to a central octagonal connector. This connector is linked to two separate boxes: 'm730:Codice' and 'm730:Importo'.</p>
children	m730:Codice m730:Importo

element **Altri_Oneri_Type/Codice**

diagram	<p>The diagram shows a single box labeled 'm730:Codice'.</p>																
type	m730:Codice Altri_Oneri_Type																
facets	<table border="1"> <thead> <tr> <th>Kind</th> <th>Value</th> </tr> </thead> <tbody> <tr> <td>enumeration</td> <td>6</td> </tr> <tr> <td>enumeration</td> <td>7</td> </tr> <tr> <td>enumeration</td> <td>8</td> </tr> <tr> <td>enumeration</td> <td>9</td> </tr> <tr> <td>enumeration</td> <td>12</td> </tr> <tr> <td>enumeration</td> <td>13</td> </tr> <tr> <td>enumeration</td> <td>21</td> </tr> </tbody> </table>	Kind	Value	enumeration	6	enumeration	7	enumeration	8	enumeration	9	enumeration	12	enumeration	13	enumeration	21
Kind	Value																
enumeration	6																
enumeration	7																
enumeration	8																
enumeration	9																
enumeration	12																
enumeration	13																
enumeration	21																

element **Altri_Oneri_Type/Importo**

diagram	
type	DatoNP_Type

complexType **Altri_Reddito_Ass_Lav_Type**

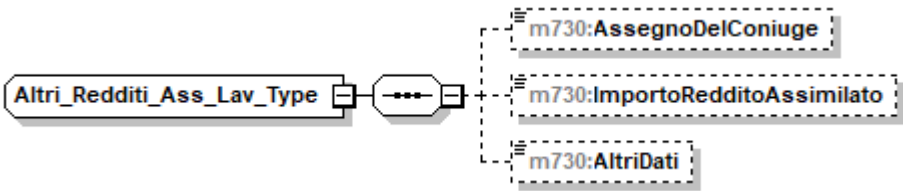
diagram	
children	m730:AssegnoDelConiuge m730:ImportoRedditoAssimilato m730:AltriDati

element **Altri_Reddito_Ass_Lav_Type/AssegnoDelConiuge**

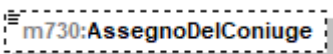
diagram	
type	DatoCB_Type

element **Altri_Reddito_Ass_Lav_Type/ImportoRedditoAssimilato**

diagram	
type	DatoNP_Type

element **Altri_Reddito_Ass_Lav_Type/AltriDati**

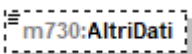
diagram							
type	restriction of DatoNP_Type						
facets	<table border="1"> <thead> <tr> <th>Kind</th> <th>Value</th> </tr> </thead> <tbody> <tr> <td>enumeration</td> <td>1</td> </tr> <tr> <td>enumeration</td> <td>5</td> </tr> </tbody> </table>	Kind	Value	enumeration	1	enumeration	5
Kind	Value						
enumeration	1						
enumeration	5						

complexType **Altri_Reddito_Diversi_Detr_Type**

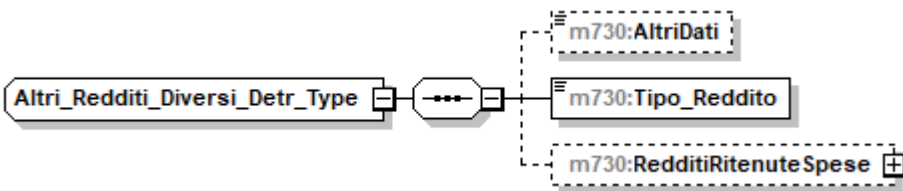
diagram	
---------	--

children	m730:AltriDati m730:Tipo_Redito m730:RedditiRitenuteSpese
----------	---

element **Altri_Redditi_Diversi_Detr_Type/AltriDati**

diagram					
type	restriction of DatoNP_Type				
facets	<table border="1"> <thead> <tr> <th>Kind</th> <th>Value</th> </tr> </thead> <tbody> <tr> <td>enumeration</td> <td>5</td> </tr> </tbody> </table>	Kind	Value	enumeration	5
Kind	Value				
enumeration	5				

element **Altri_Redditi_Diversi_Detr_Type/Tipo_Redito**

diagram													
type	restriction of DatoNP_Type												
facets	<table border="1"> <thead> <tr> <th>Kind</th> <th>Value</th> </tr> </thead> <tbody> <tr> <td>enumeration</td> <td>1</td> </tr> <tr> <td>enumeration</td> <td>2</td> </tr> <tr> <td>enumeration</td> <td>3</td> </tr> <tr> <td>enumeration</td> <td>4</td> </tr> <tr> <td>enumeration</td> <td>5</td> </tr> </tbody> </table>	Kind	Value	enumeration	1	enumeration	2	enumeration	3	enumeration	4	enumeration	5
Kind	Value												
enumeration	1												
enumeration	2												
enumeration	3												
enumeration	4												
enumeration	5												

element **Altri_Redditi_Diversi_Detr_Type/RedditiRitenuteSpese**

diagram	
type	m730:Redditi_Ritenute_Spese_Type
children	m730:ImportoRedditi m730:ImportoRitenute m730:ImportoSpese

complexType **Altri_Redditi_Diversi_Type**

diagram	
children	m730:CedolareSecca m730:TipoRedito m730:RedditiRitenuteSpese

element **Altri_Reddito_Diversi_Type/CedolareSecca**

diagram	
type	DatoCB_Type

element **Altri_Reddito_Diversi_Type/TipoReddito**

diagram																													
type	restriction of DatoNP_Type																												
facets	<table border="1"> <thead> <tr> <th>Kind</th> <th>Value</th> </tr> </thead> <tbody> <tr><td>enumeration</td><td>1</td></tr> <tr><td>enumeration</td><td>2</td></tr> <tr><td>enumeration</td><td>3</td></tr> <tr><td>enumeration</td><td>4</td></tr> <tr><td>enumeration</td><td>5</td></tr> <tr><td>enumeration</td><td>6</td></tr> <tr><td>enumeration</td><td>7</td></tr> <tr><td>enumeration</td><td>8</td></tr> <tr><td>enumeration</td><td>9</td></tr> <tr><td>enumeration</td><td>10</td></tr> <tr><td>enumeration</td><td>11</td></tr> <tr><td>enumeration</td><td>12</td></tr> <tr><td>enumeration</td><td>13</td></tr> </tbody> </table>	Kind	Value	enumeration	1	enumeration	2	enumeration	3	enumeration	4	enumeration	5	enumeration	6	enumeration	7	enumeration	8	enumeration	9	enumeration	10	enumeration	11	enumeration	12	enumeration	13
Kind	Value																												
enumeration	1																												
enumeration	2																												
enumeration	3																												
enumeration	4																												
enumeration	5																												
enumeration	6																												
enumeration	7																												
enumeration	8																												
enumeration	9																												
enumeration	10																												
enumeration	11																												
enumeration	12																												
enumeration	13																												

element **Altri_Reddito_Diversi_Type/RedditiRitenuteSpese**

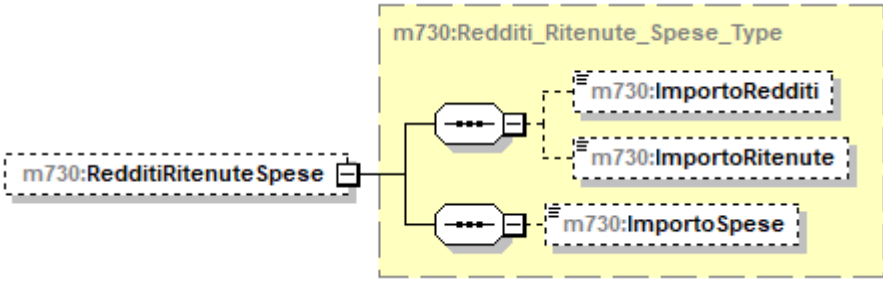
diagram	
type	m730:Redditi_Ritenute_Spese_Type
children	m730:ImportoRedditi m730:ImportoRitenute m730:ImportoSpese

complexType **Altri_Reddito_Lavoro_Autonomo_Type**

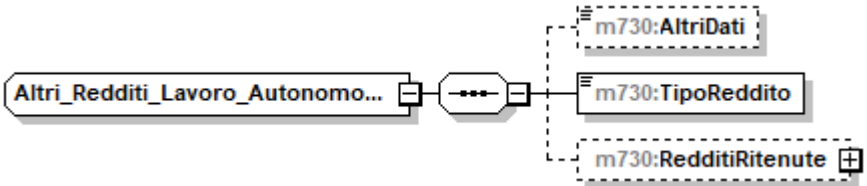
diagram	
children	m730:AltriDati m730:TipoReddito m730:RedditiRitenute

element **Altri_Reddito_Lavoro_Autonomo_Type/AltriDati**

diagram					
type	restriction of DatoNP_Type				
facets	<table border="1"> <thead> <tr> <th>Kind</th> <th>Value</th> </tr> </thead> <tbody> <tr> <td>enumeration</td> <td>5</td> </tr> </tbody> </table>	Kind	Value	enumeration	5
Kind	Value				
enumeration	5				

element **Altri_Reddito_Lavoro_Autonomo_Type/TipoReddito**

diagram													
type	restriction of DatoNP_Type												
facets	<table border="1"> <thead> <tr> <th>Kind</th> <th>Value</th> </tr> </thead> <tbody> <tr> <td>enumeration</td> <td>1</td> </tr> <tr> <td>enumeration</td> <td>2</td> </tr> <tr> <td>enumeration</td> <td>3</td> </tr> <tr> <td>enumeration</td> <td>4</td> </tr> <tr> <td>enumeration</td> <td>5</td> </tr> </tbody> </table>	Kind	Value	enumeration	1	enumeration	2	enumeration	3	enumeration	4	enumeration	5
Kind	Value												
enumeration	1												
enumeration	2												
enumeration	3												
enumeration	4												
enumeration	5												

element **Altri_Reddito_Lavoro_Autonomo_Type/RedditiRitenute**

diagram	
type	m730:Redditi_Ritenute_Type
children	m730:ImportoRedditi m730:ImportoRitenute

complexType **Altri_Reddito_Type**

diagram	
children	m730:Modulo

element **Altri_Reddito_Type/Modulo**

diagram	
---------	--

type	m730:Modulo Altri Redditi Type
children	m730:RedditiDiCapitale m730:RedditiTassazioneSeparata

complexType **Altri_Redditi_Utili_Type**

diagram	
children	m730:Tipo_Reddito m730:RedditiRitenute

element **Altri_Redditi_Utili_Type/Tipo_Reddito**

diagram																									
type	restriction of DatoNP_Type																								
facets	<table border="1"> <thead> <tr> <th>Kind</th> <th>Value</th> </tr> </thead> <tbody> <tr><td>enumeration</td><td>1</td></tr> <tr><td>enumeration</td><td>2</td></tr> <tr><td>enumeration</td><td>3</td></tr> <tr><td>enumeration</td><td>4</td></tr> <tr><td>enumeration</td><td>5</td></tr> <tr><td>enumeration</td><td>6</td></tr> <tr><td>enumeration</td><td>7</td></tr> <tr><td>enumeration</td><td>8</td></tr> <tr><td>enumeration</td><td>9</td></tr> <tr><td>enumeration</td><td>10</td></tr> <tr><td>enumeration</td><td>11</td></tr> </tbody> </table>	Kind	Value	enumeration	1	enumeration	2	enumeration	3	enumeration	4	enumeration	5	enumeration	6	enumeration	7	enumeration	8	enumeration	9	enumeration	10	enumeration	11
Kind	Value																								
enumeration	1																								
enumeration	2																								
enumeration	3																								
enumeration	4																								
enumeration	5																								
enumeration	6																								
enumeration	7																								
enumeration	8																								
enumeration	9																								
enumeration	10																								
enumeration	11																								

element **Altri_Redditi_Utili_Type/RedditiRitenute**

diagram	
type	m730:Redditi_Ritenute_Type
children	m730:ImportoRedditi m730:ImportoRitenute

complexType **Annotazione_Type**

diagram	
children	m730:Codice m730:RigoQuadro m730:ModuloQuadro m730:Importo

element **Annotazione_Type/Codice**

diagram	
type	DatoAN_Type

element **Annotazione_Type/RigoQuadro**

diagram	
type	DatoNP_Type

element **Annotazione_Type/ModuloQuadro**

diagram	
type	DatoNP_Type

element **Annotazione_Type/Importo**

diagram	
type	DatoNP_Type

complexType **Assegno_Coniuge_Type**

diagram	
children	m730:CodiceFiscale m730:Importo

element **Assegno_Coniuge_Type/CodiceFiscale**

diagram	
type	DatoCF_Type

element **Assegno_Coniuge_Type/Importo**

diagram	
type	DatoNP_Type

complexType **Casella_Acconto_Type**

diagram	
children	m730:Casella m730:ImportoMisuralInferiore

element **Casella_Acconto_Type/Casella**

diagram	
type	DatoCB_Type

element **Casella_Acconto_Type/ImportoMisuralInferiore**

diagram	
type	DatoNP_Type

complexType **Cedolare_Secca_Type**

diagram	
children	m730:CedolareDovuta m730:CedolareDifferenza m730:EccedenzaCedolareSecca m730:AccontoCedolare

element **Cedolare_Secca_Type/CedolareDovuta**

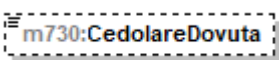
diagram	
type	DatoNP_Type

element **Cedolare_Secca_Type/CedolareDifferenza**

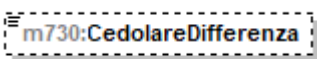
diagram	
type	DatoNP_Type

element **Cedolare_Secca_Type/EccedenzaCedolareSecca**

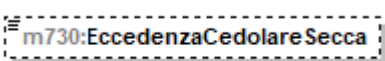
diagram	
type	DatoNU_Type

element **Cedolare_Secca_Type/AccontoCedolare**

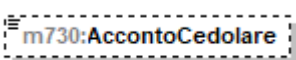
diagram	
type	DatoNP_Type

complexType **Comparto_Sicurezza_Type**

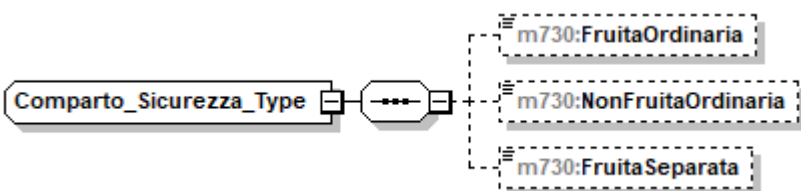
diagram	
children	m730:FruitaOrdinaria m730:NonFruitaOrdinaria m730:FruitaSeparata

element **Comparto_Sicurezza_Type/FruitaOrdinaria**

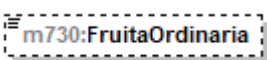
diagram	
type	DatoNP_Type

element **Comparto_Sicurezza_Type/NonFruitaOrdinaria**

diagram	
type	DatoNP_Type

element **Comparto_Sicurezza_Type/FruitaSeparata**

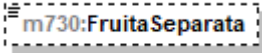
diagram	
type	DatoNP_Type

complexType **Compensazione_Type**

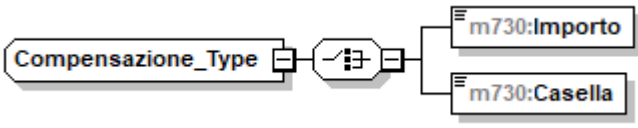
diagram	
children	m730:Importo m730:Casella

element **Compensazione_Type/Importo**

diagram	
type	DatoNP_Type

element **Compensazione_Type/Casella**

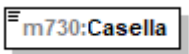
diagram	
type	DatoCB_Type

complexType **Comunicazione_Amministratore_Type**

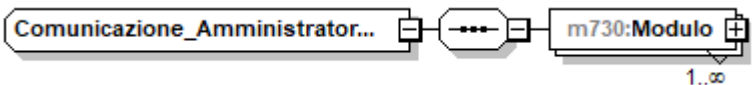
diagram	
children	m730:Modulo

element **Comunicazione_Administratore_Type/Modulo**

diagram	
type	m730:Modulo_Communicazione_Type
children	m730:DatiCondominio m730:DatiCatastali m730:DomandaAccatamento m730:DatiFornitore

complexType **Conguaglio_Sostitutive_Type**

diagram	
children	m730:ImportoSaldoDic m730:ImportoSaldoCon m730:ImportoAccontoDic m730:ImportoAccontoCon m730:ImportoCreditoDic m730:ImportoCreditoCon

element **Conguaglio_Sostitutive_Type/ImportoSaldoDic**

diagram	
type	DatoNP_Type

element **Conguaglio_Sostitutive_Type/ImportoSaldoCon**

diagram	
type	DatoNP_Type

element **Conguaglio_Sostitutive_Type/ImportoAccontoDic**

diagram	
type	DatoNP_Type

element **Conguaglio_Sostitutive_Type/ImportoAccontoCon**

diagram	
type	DatoNP_Type

element **Conguaglio_Sostitutive_Type/ImportoCreditoDic**

diagram	
type	DatoNP_Type

element **Conguaglio_Sostitutive_Type/ImportoCreditoCon**

diagram	
type	DatoNP_Type

complexType **Conguaglio_Type**

diagram	
children	m730:NumeroRate m730:ImportoTrattenutoSaldo m730:ImportoTrattenutoAcconto m730:ImportoDaVersareF24Saldo m730:ImportoDaVersareF24Acc... m730:ImportoRimborsato m730:ImportoRimborsatoAgenzia m730:OpzioneInformativa

element **Conguaglio_Type/NumeroRate**

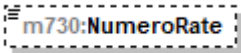
diagram															
type	restriction of DatoN1_Type														
facets	<table border="1"> <thead> <tr> <th>Kind</th> <th>Value</th> </tr> </thead> <tbody> <tr> <td>enumeration</td> <td>2</td> </tr> <tr> <td>enumeration</td> <td>3</td> </tr> <tr> <td>enumeration</td> <td>4</td> </tr> <tr> <td>enumeration</td> <td>5</td> </tr> <tr> <td>enumeration</td> <td>6</td> </tr> <tr> <td>enumeration</td> <td>7</td> </tr> </tbody> </table>	Kind	Value	enumeration	2	enumeration	3	enumeration	4	enumeration	5	enumeration	6	enumeration	7
Kind	Value														
enumeration	2														
enumeration	3														
enumeration	4														
enumeration	5														
enumeration	6														
enumeration	7														

element **Conguaglio_Type/ImportoTrattenutoSaldo**

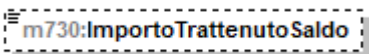
diagram	
type	DatoNP_Type

element **Conguaglio_Type/ImportoTrattenutoAcconto**

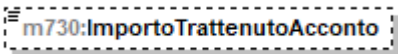
diagram	
type	DatoNP_Type

element **Conguaglio_Type/ImportoDaVersareF24Saldo**

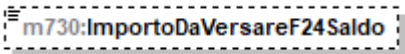
diagram	
type	DatoNP_Type

element **Conguaglio_Type/ImportoDaVersareF24Acconto**

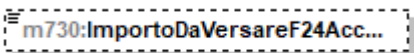
diagram	
type	DatoNP_Type

element **Conguaglio_Type/ImportoRimborsato**

diagram	
type	DatoNP_Type

element **Conguaglio_Type/ImportoRimborsatoAgenzia**

diagram	
type	DatoNP_Type

element **Conguaglio_Type/OpzioneInformativa**

diagram	
type	DatoCB_Type

complexType **Contributi_Previdenza_Complementare_Type**

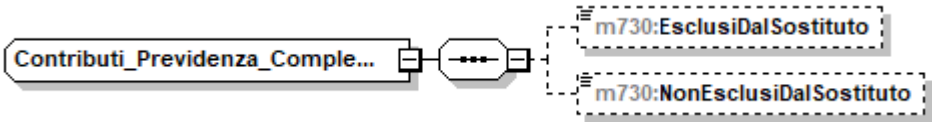
diagram	
children	m730:EsclusiDalSostituto m730:NonEsclusiDalSostituto

element **Contributi_Previdenza_Complementare_Type/EsclusiDalSostituto**

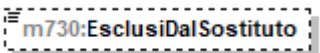
diagram	
type	DatoNP_Type

element **Contributi_Previdenza_Complementare_Type/NonEsclusiDalSostituto**

diagram	
type	DatoNP_Type

complexType **Contributo_Solidarieta_Type**

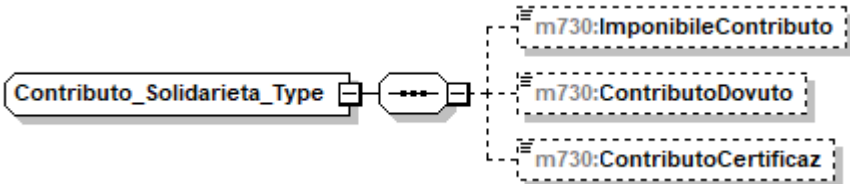
diagram	
children	m730:ImponibileContributo m730:ContributoDovuto m730:ContributoCertificaz

element **Contributo_Solidarieta_Type/ImponibileContributo**

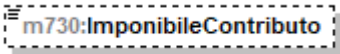
diagram	
type	DatoNP_Type

element **Contributo_Solidarieta_Type/ContributoDovuto**

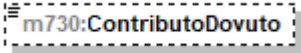
diagram	
type	DatoNP_Type

element **Contributo_Solidarieta_Type/ContributoCertificaz**

diagram	
type	DatoNP_Type

complexType **Cred_Erogazione_Cultura_Type**

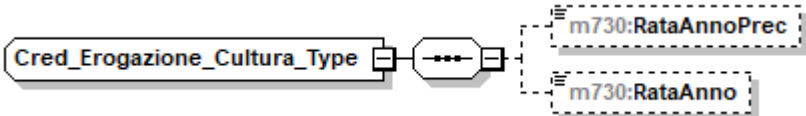
diagram	
children	m730:RataAnnoPrec m730:RataAnno

element **Cred_Erogazione_Cultura_Type/RataAnnoPrec**

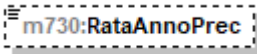
diagram	
type	DatoNP_Type

element **Cred_Erogazione_Cultura_Type/RataAnno**

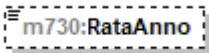
diagram	
type	DatoNP_Type

complexType Cred_Imp_Estero_Type

diagram	
children	m730:Anno m730:TotCredito m730:CreditoStato

element Cred_Imp_Estero_Type/Anno

diagram	
type	DatoDA_Type

element Cred_Imp_Estero_Type/TotCredito

diagram	
type	DatoNP_Type

element Cred_Imp_Estero_Type/CreditoStato

diagram	
type	m730:Credito_Stato_Type
children	m730:Stato m730:Credito

complexType **Crediti_F24_Type**

<p>diagram</p>	
<p>children</p>	<p>m730:Credlrpef m730:CredlrpefDipNoSostituto m730:CodAddReg m730:CredAddReg m730:CredAddRegDipNoSostituto m730:CodiceAddCom m730:CredAddCom m730:CredAddComDipNoSostituto m730:CredCedolare m730:CredCedolareDipNoSostituto m730:CredTassSeparDipNoSostituto m730:CredImpostaSostDipNoSostituto m730:DatiF24Cripto m730:DatiF24lvie m730:DatiF24lvafe m730:DatiF24FonteEstera m730:DatiF24Mance m730:TotaleCredito m730:TotaleDipNoSostituto m730:TotaleDebito</p>

element **Crediti_F24_Type/Credlrpef**

<p>diagram</p>	
----------------	--

type	DatoNP_Type
------	-----------------------------

element **Crediti_F24_Type/CredIrpefDipNoSostituto**

diagram	
type	DatoNP_Type

element **Crediti_F24_Type/CodAddReg**

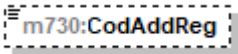
diagram																																													
type	Codice Regione_Type																																												
facets	<table border="1"> <thead> <tr> <th>Kind</th> <th>Value</th> </tr> </thead> <tbody> <tr><td>enumeration</td><td>1</td></tr> <tr><td>enumeration</td><td>2</td></tr> <tr><td>enumeration</td><td>3</td></tr> <tr><td>enumeration</td><td>4</td></tr> <tr><td>enumeration</td><td>5</td></tr> <tr><td>enumeration</td><td>6</td></tr> <tr><td>enumeration</td><td>7</td></tr> <tr><td>enumeration</td><td>8</td></tr> <tr><td>enumeration</td><td>9</td></tr> <tr><td>enumeration</td><td>10</td></tr> <tr><td>enumeration</td><td>11</td></tr> <tr><td>enumeration</td><td>12</td></tr> <tr><td>enumeration</td><td>13</td></tr> <tr><td>enumeration</td><td>14</td></tr> <tr><td>enumeration</td><td>15</td></tr> <tr><td>enumeration</td><td>16</td></tr> <tr><td>enumeration</td><td>17</td></tr> <tr><td>enumeration</td><td>18</td></tr> <tr><td>enumeration</td><td>19</td></tr> <tr><td>enumeration</td><td>20</td></tr> <tr><td>enumeration</td><td>21</td></tr> </tbody> </table>	Kind	Value	enumeration	1	enumeration	2	enumeration	3	enumeration	4	enumeration	5	enumeration	6	enumeration	7	enumeration	8	enumeration	9	enumeration	10	enumeration	11	enumeration	12	enumeration	13	enumeration	14	enumeration	15	enumeration	16	enumeration	17	enumeration	18	enumeration	19	enumeration	20	enumeration	21
Kind	Value																																												
enumeration	1																																												
enumeration	2																																												
enumeration	3																																												
enumeration	4																																												
enumeration	5																																												
enumeration	6																																												
enumeration	7																																												
enumeration	8																																												
enumeration	9																																												
enumeration	10																																												
enumeration	11																																												
enumeration	12																																												
enumeration	13																																												
enumeration	14																																												
enumeration	15																																												
enumeration	16																																												
enumeration	17																																												
enumeration	18																																												
enumeration	19																																												
enumeration	20																																												
enumeration	21																																												

element **Crediti_F24_Type/CredAddReg**

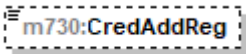
diagram	
type	DatoNP_Type

element **Crediti_F24_Type/CredAddRegDipNoSostituto**

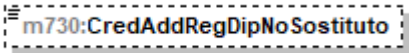
diagram	
type	DatoNP_Type

element **Crediti_F24_Type/CodiceAddCom**

diagram	
type	DatoAN_Type

element **Crediti_F24_Type/CredAddCom**

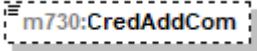
diagram	
type	DatoNP_Type

element **Crediti_F24_Type/CredAddComDipNoSostituto**

diagram	
type	DatoNP_Type

element **Crediti_F24_Type/CredCedolare**

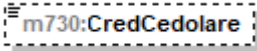
diagram	
type	DatoNP_Type

element **Crediti_F24_Type/CredCedolareDipNoSostituto**

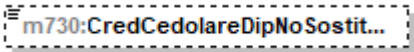
diagram	
type	DatoNP_Type

element **Crediti_F24_Type/CredTassSeparDipNoSostituto**

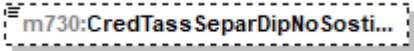
diagram	
type	DatoNP_Type

element **Crediti_F24_Type/CredImpostaSostDipNoSostituto**

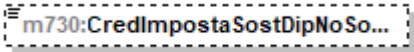
diagram	
type	DatoNP_Type

element **Crediti_F24_Type/DatiF24Cripto**

diagram	<p>The diagram shows a class <code>m730:Dati_F24_Type</code> (highlighted in yellow) containing four sub-elements: <code>m730:Credito</code>, <code>m730:Debito</code>, <code>m730:PrimaRataAcconto</code>, and <code>m730:SecondaRataAcconto</code>. A separate class <code>m730:DatiF24Cripto</code> is shown with a dashed border, connected to the <code>m730:Dati_F24_Type</code> class by a solid line with an open arrowhead pointing towards the parent class, indicating a generalization relationship.</p>
type	m730:Dati_F24_Type
children	m730:Credito m730:Debito m730:PrimaRataAcconto m730:SecondaRataAcconto

element **Crediti_F24_Type/DatiF24Ivie**

diagram	<p>The diagram shows a class <code>m730:Dati_F24_Type</code> (highlighted in yellow) containing four sub-elements: <code>m730:Credito</code>, <code>m730:Debito</code>, <code>m730:PrimaRataAcconto</code>, and <code>m730:SecondaRataAcconto</code>. A separate class <code>m730:DatiF24Ivie</code> is shown with a dashed border, connected to the <code>m730:Dati_F24_Type</code> class by a solid line with an open arrowhead pointing towards the parent class, indicating a generalization relationship.</p>
type	m730:Dati_F24_Type
children	m730:Credito m730:Debito m730:PrimaRataAcconto m730:SecondaRataAcconto

element **Crediti_F24_Type/DatiF24Ivafe**

diagram	<p>The diagram shows a class <code>m730:Dati_F24_Type</code> (highlighted in yellow) containing four sub-elements: <code>m730:Credito</code>, <code>m730:Debito</code>, <code>m730:PrimaRataAcconto</code>, and <code>m730:SecondaRataAcconto</code>. A separate class <code>m730:DatiF24Ivafe</code> is shown with a dashed border, connected to the <code>m730:Dati_F24_Type</code> class by a solid line with an open arrowhead pointing towards the parent class, indicating a generalization relationship.</p>
type	m730:Dati_F24_Type
children	m730:Credito m730:Debito m730:PrimaRataAcconto m730:SecondaRataAcconto

element **Crediti_F24_Type/DatiF24FonteEstera**

diagram	
children	m730:Credito m730:Debito

element **Crediti_F24_Type/DatiF24FonteEstera/Credito**

diagram	
type	DatoNP_Type

element **Crediti_F24_Type/DatiF24FonteEstera/Debito**

diagram	
type	DatoNP_Type

element **Crediti_F24_Type/DatiF24Mance**

diagram	
children	m730:Credito m730:Debito

element **Crediti_F24_Type/DatiF24Mance/Credito**

diagram	
type	DatoNP_Type

element **Crediti_F24_Type/DatiF24Mance/Debito**

diagram	
type	DatoNP_Type

element **Crediti_F24_Type/TotaleCredito**

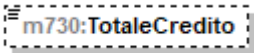
diagram	
type	DatoNP_Type

element **Crediti_F24_Type/TotaleDipNoSostituto**

diagram	
type	DatoNP_Type

element **Crediti_F24_Type/TotaleDebito**

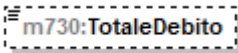
diagram	
type	DatoNP_Type

complexType **Crediti_Imposta_Altri_Sisma_Abruzzo_Type**

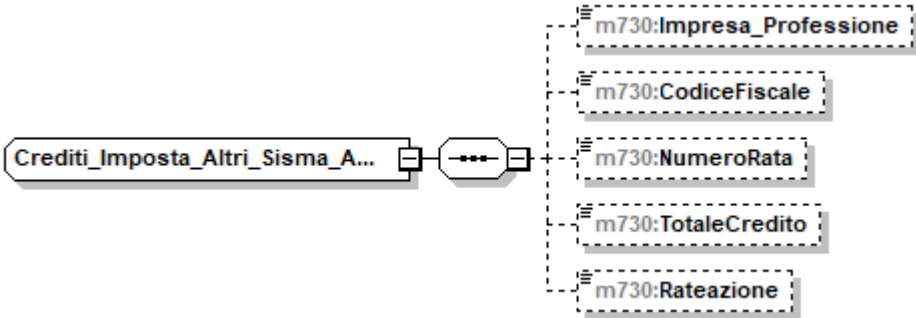
diagram	
children	m730:Impresa_Professione m730:CodiceFiscale m730:NumeroRata m730:TotaleCredito m730:Rateazione

element **Crediti_Imposta_Altri_Sisma_Abruzzo_Type/Impresa_Professione**

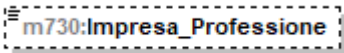
diagram	
type	DatoCB_Type

element **Crediti_Imposta_Altri_Sisma_Abruzzo_Type/CodiceFiscale**

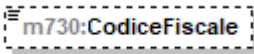
diagram	
type	DatoCF_Type

element **Crediti_Imposta_Altri_Sisma_Abruzzo_Type/NumeroRata**

diagram																							
type	restriction of DatoNP_Type																						
facets	<table border="1"> <thead> <tr> <th>Kind</th> <th>Value</th> </tr> </thead> <tbody> <tr><td>enumeration</td><td>1</td></tr> <tr><td>enumeration</td><td>2</td></tr> <tr><td>enumeration</td><td>3</td></tr> <tr><td>enumeration</td><td>4</td></tr> <tr><td>enumeration</td><td>5</td></tr> <tr><td>enumeration</td><td>6</td></tr> <tr><td>enumeration</td><td>7</td></tr> <tr><td>enumeration</td><td>8</td></tr> <tr><td>enumeration</td><td>9</td></tr> <tr><td>enumeration</td><td>10</td></tr> </tbody> </table>	Kind	Value	enumeration	1	enumeration	2	enumeration	3	enumeration	4	enumeration	5	enumeration	6	enumeration	7	enumeration	8	enumeration	9	enumeration	10
Kind	Value																						
enumeration	1																						
enumeration	2																						
enumeration	3																						
enumeration	4																						
enumeration	5																						
enumeration	6																						
enumeration	7																						
enumeration	8																						
enumeration	9																						
enumeration	10																						

element **Crediti_Imposta_Altri_Sisma_Abruzzo_Type/TotaleCredito**

diagram	
type	DatoNP_Type

element **Crediti_Imposta_Altri_Sisma_Abruzzo_Type/Rateazione**

diagram							
type	restriction of DatoNP_Type						
facets	<table border="1"> <thead> <tr> <th>Kind</th> <th>Value</th> </tr> </thead> <tbody> <tr><td>enumeration</td><td>5</td></tr> <tr><td>enumeration</td><td>10</td></tr> </tbody> </table>	Kind	Value	enumeration	5	enumeration	10
Kind	Value						
enumeration	5						
enumeration	10						

complexType **Crediti_Imposta_Fabbicati_Type**

diagram	
children	m730:ResiduoFabbicati m730:CanoniLocazioneNonPerceptiti

element **Crediti_Imposta_Fabbricati_Type/ResiduoFabbricati**

diagram	
type	m730:Residuo_Fabbricati_Type
children	m730:ResiduoPrecedenteDichiarazione m730:CreditoAnno m730:DiCuiCompensatoF24

element **Crediti_Imposta_Fabbricati_Type/CanoniLocazioneNonPercepiti**

diagram	
type	DatoNP_Type

complexType **Crediti_Imposta_Fondi_Pensione_Type**

diagram	
children	m730:AnnoAnticipazione m730:Reintegro m730:SommaReintegrata m730:CreditoAnno

element **Crediti_Imposta_Fondi_Pensione_Type/AnnoAnticipazione**

diagram																													
type	m730:Anno_Anticipazione_Fondo_Pensione_Type																												
facets	<table border="1"> <thead> <tr> <th>Kind</th> <th>Value</th> </tr> </thead> <tbody> <tr><td>enumeration</td><td>2007</td></tr> <tr><td>enumeration</td><td>2008</td></tr> <tr><td>enumeration</td><td>2009</td></tr> <tr><td>enumeration</td><td>2010</td></tr> <tr><td>enumeration</td><td>2011</td></tr> <tr><td>enumeration</td><td>2012</td></tr> <tr><td>enumeration</td><td>2013</td></tr> <tr><td>enumeration</td><td>2014</td></tr> <tr><td>enumeration</td><td>2015</td></tr> <tr><td>enumeration</td><td>2016</td></tr> <tr><td>enumeration</td><td>2017</td></tr> <tr><td>enumeration</td><td>2018</td></tr> <tr><td>enumeration</td><td>2019</td></tr> </tbody> </table>	Kind	Value	enumeration	2007	enumeration	2008	enumeration	2009	enumeration	2010	enumeration	2011	enumeration	2012	enumeration	2013	enumeration	2014	enumeration	2015	enumeration	2016	enumeration	2017	enumeration	2018	enumeration	2019
Kind	Value																												
enumeration	2007																												
enumeration	2008																												
enumeration	2009																												
enumeration	2010																												
enumeration	2011																												
enumeration	2012																												
enumeration	2013																												
enumeration	2014																												
enumeration	2015																												
enumeration	2016																												
enumeration	2017																												
enumeration	2018																												
enumeration	2019																												

	enumeration	2020
	enumeration	2021
	enumeration	2022
	enumeration	2023

element **Crediti Imposta Fondi Pensione Type/Reintegro**

diagram							
type	m730:Reintegro Totale Parziale Type						
facets	<table border="1"> <tr> <td>Kind</td> <td>Value</td> </tr> <tr> <td>enumeration</td> <td>1</td> </tr> <tr> <td>enumeration</td> <td>2</td> </tr> </table>	Kind	Value	enumeration	1	enumeration	2
Kind	Value						
enumeration	1						
enumeration	2						

element **Crediti Imposta Fondi Pensione Type/SommaReintegrata**

diagram	
type	DatoNP Type

element **Crediti Imposta Fondi Pensione Type/CreditoAnno**

diagram	
type	DatoNP Type

complexType **Crediti Imposta Redditi Esteri Type**

diagram	<p>The diagram shows a complex type container labeled 'Crediti Imposta Redditi Esteri_...' connected to a sequence container (represented by a circle with four dots). This sequence container lists the following elements from top to bottom: m730:StatoEstero, m730:Anno, m730:RedditoEstero, m730:ImpostaEstera, m730:RedditoComplessivo, m730:Imposta_Lorda, m730:ImpostaNetta, m730:CreditoDichiarazioniPrece..., and m730:DiCuiStatoEstero.</p>
children	m730:StatoEstero m730:Anno m730:RedditoEstero m730:ImpostaEstera m730:RedditoComplessivo m730:Imposta_Lorda m730:ImpostaNetta m730:CreditoDichiarazioniPrecedenti m730:DiCuiStatoEstero

element **Crediti_Imposta_Reddito_Esteri_Type/StatoEster**

diagram	
type	DatoAN_Type

element **Crediti_Imposta_Reddito_Esteri_Type/Anno**

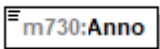
diagram	
type	restriction of DatoDA_Type

element **Crediti_Imposta_Reddito_Esteri_Type/RedditoEster**

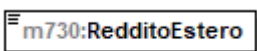
diagram	
type	DatoNP_Type

element **Crediti_Imposta_Reddito_Esteri_Type/ImpostaEster**

diagram	
type	DatoNP_Type

element **Crediti_Imposta_Reddito_Esteri_Type/RedditoComplessivo**

diagram	
type	DatoNP_Type

element **Crediti_Imposta_Reddito_Esteri_Type/Imposta_Lorda**

diagram	
type	DatoNP_Type

element **Crediti_Imposta_Reddito_Esteri_Type/ImpostaNetta**

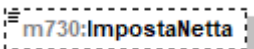
diagram	
type	DatoNP_Type

element **Crediti_Imposta_Redditi_Esteri_Type/CreditoDichiarazioniPrecedenti**

diagram	
type	DatoNP_Type

element **Crediti_Imposta_Redditi_Esteri_Type/DiCuiStatoEstero**

diagram	
type	DatoNP_Type

complexType **Crediti_Imposta_Type**

diagram	
children	m730:PrimoModulo m730:Modulo

element **Crediti_Imposta_Type/PrimoModulo**

diagram	
type	m730:Primo Modulo Crediti Imposta Type
children	m730:CreditoImpostaFabbricati m730:CreditoImpostaFondiPensione m730:CreditoImpostaRedditiEsteri m730:CreditoPrimaCasaSismaAbruzzo m730:CreditoAltriSismaAbruzzo m730:CreditoPrimaCasaU36 m730:CreditoErogazioniCultura m730:AltriCreditoImposta

element **Crediti_Imposta_Type/Modulo**

diagram	
type	m730:Modulo_Crediti_Imposta_Type
children	m730:CreditoImpostaFondiPensione m730:CreditoImpostaRedditiEsteri m730:CreditoPrimaCasaSismaAbruzzo m730:CreditoAltriSismaAbruzzo m730:AltriCreditoImposta

complexType **Credito_Ape**

diagram	
children	m730:Utilizzato

element **Credito_Ape/Utilizzato**

diagram	
type	DatoNP_Type

complexType **Credito_Erogazioni_Cultura_Type**

diagram	
children	m730:SpesaAnno m730:ResiduoAnnoPrec m730:RataAnnoPrec m730:RataDueAnniPrec

element **Credito_Erogazioni_Cultura_Type/SpesaAnno**

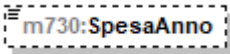
diagram	
type	DatoNP_Type

element **Credito_Erogazioni_Cultura_Type/ResiduoAnnoPrec**

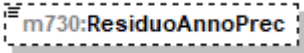
diagram	
type	DatoNP_Type

element **Credito_Erogazioni_Cultura_Type/RataAnnoPrec**

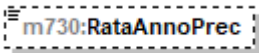
diagram	
type	DatoNP_Type

element **Credito_Erogazioni_Cultura_Type/RataDueAnniPrec**

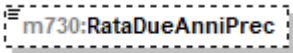
diagram	
type	DatoNP_Type

complexType **Credito_Erogazioni_Scuola_Type**

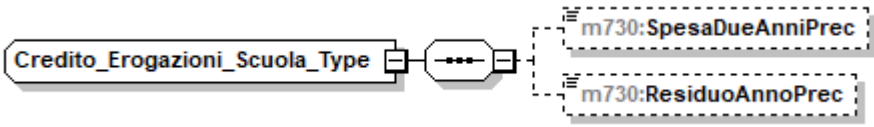
diagram	
children	m730:SpesaDueAnniPrec m730:ResiduoAnnoPrec

element **Credito_Erogazioni_Scuola_Type/SpesaDueAnniPrec**

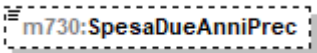
diagram	
type	DatoNP_Type

element **Credito_Erogazioni_Scuola_Type/ResiduoAnnoPrec**

diagram	
type	DatoNP_Type

complexType **Credito_Immobile_Sisma_Abruzzo_Type**

diagram	
children	m730:CodiceFiscale m730:NumeroRata m730:TotaleCredito

element **Credito_Immobile_Sisma_Abruzzo_Type/CodiceFiscale**

diagram	
type	DatoCF_Type

element **Credito_Immobile_Sisma_Abruzzo_Type/NumeroRata**

diagram																																	
type	restriction of DatoNP_Type																																
facets	<table border="1"> <thead> <tr> <th>Kind</th> <th>Value</th> </tr> </thead> <tbody> <tr><td>enumeration</td><td>1</td></tr> <tr><td>enumeration</td><td>2</td></tr> <tr><td>enumeration</td><td>3</td></tr> <tr><td>enumeration</td><td>4</td></tr> <tr><td>enumeration</td><td>5</td></tr> <tr><td>enumeration</td><td>6</td></tr> <tr><td>enumeration</td><td>7</td></tr> <tr><td>enumeration</td><td>8</td></tr> <tr><td>enumeration</td><td>9</td></tr> <tr><td>enumeration</td><td>10</td></tr> <tr><td>enumeration</td><td>11</td></tr> <tr><td>enumeration</td><td>12</td></tr> <tr><td>enumeration</td><td>13</td></tr> <tr><td>enumeration</td><td>14</td></tr> <tr><td>enumeration</td><td>15</td></tr> </tbody> </table>	Kind	Value	enumeration	1	enumeration	2	enumeration	3	enumeration	4	enumeration	5	enumeration	6	enumeration	7	enumeration	8	enumeration	9	enumeration	10	enumeration	11	enumeration	12	enumeration	13	enumeration	14	enumeration	15
Kind	Value																																
enumeration	1																																
enumeration	2																																
enumeration	3																																
enumeration	4																																
enumeration	5																																
enumeration	6																																
enumeration	7																																
enumeration	8																																
enumeration	9																																
enumeration	10																																
enumeration	11																																
enumeration	12																																
enumeration	13																																
enumeration	14																																
enumeration	15																																

element **Credito_Immobile_Sisma_Abruzzo_Type/TotaleCredito**

diagram	
type	DatoNP_Type

complexType **Credito_Incremento_Occupazione_Type**

diagram	
children	m730:ResiduoPrecedenteDichiarazione m730:DiCuiCompensatoF24

element **Credito_Incremento_Occupazione_Type/ResiduoPrecedenteDichiarazione**

diagram	
type	DatoNP_Type

element **Credito_Incremento_Occupazione_Type/DiCuiCompensatoF24**

diagram	
type	DatoNP_Type

complexType **Credito_Negoziatore_Type**

diagram	
children	m730:CreditoSpettante m730:ResiduoAnnoPrec m730:DiCuiCompensatoF24

element **Credito_Negoziatore_Type/CreditoSpettante**

diagram	
type	DatoNP_Type

element **Credito_Negoziatore_Type/ResiduoAnnoPrec**

diagram	
type	DatoNP_Type

element **Credito_Negoziatore_Type/DiCuiCompensatoF24**

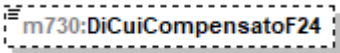
diagram	
type	DatoNP_Type

complexType **Credito_Prima_Casa_U36**

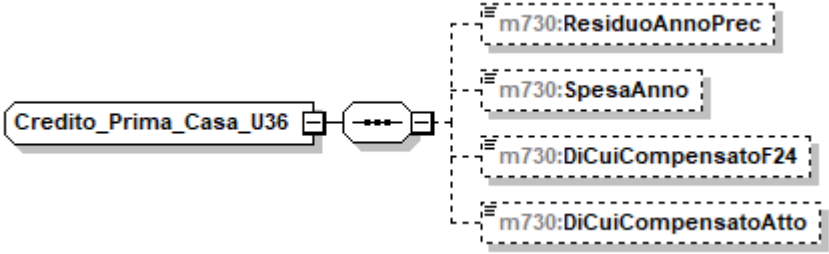
diagram	
children	m730:ResiduoAnnoPrec m730:SpesaAnno m730:DiCuiCompensatoF24 m730:DiCuiCompensatoAtto

element **Credito_Prima_Casa_U36/ResiduoAnnoPrec**

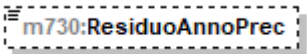
diagram	
type	DatoNP_Type

element **Credito_Prima_Casa_U36/SpesaAnno**

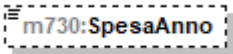
diagram	
type	DatoNP_Type

element **Credito_Prima_Casa_U36/DiCuiCompensatoF24**

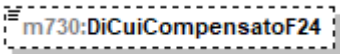
diagram	
type	DatoNP_Type

element **Credito_Prima_Casa_U36/DiCuiCompensatoAtto**

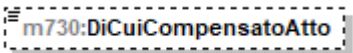
diagram	
type	DatoNP_Type

complexType **Credito_Stato_Type**

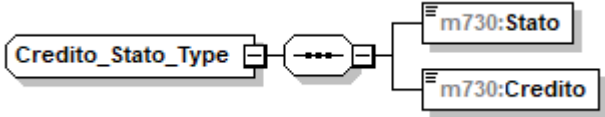
diagram	
children	m730:Stato m730:Credito

element **Credito_Stato_Type/Stato**

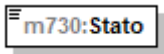
diagram	
type	DatoAN_Type

element **Credito_Stato_Type/Credito**

diagram	
type	DatoNP_Type

complexType **Credito_Type**

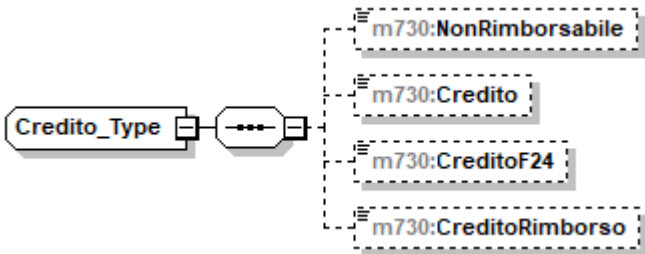
diagram	
children	m730:NonRimborsabile m730:Credito m730:CreditoF24 m730:CreditoRimborso

element **Credito_Type/NonRimborsabile**

diagram	
type	DatoNP_Type

element **Credito_Type/Credito**

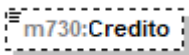
diagram	
type	DatoNP_Type

element **Credito_Type/CreditoF24**

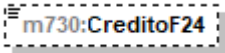
diagram	
type	DatoNP_Type

element **Credito_Type/CreditoRimborso**

diagram	
type	DatoNP_Type

complexType **Credito_Videosorveglianza_Type**

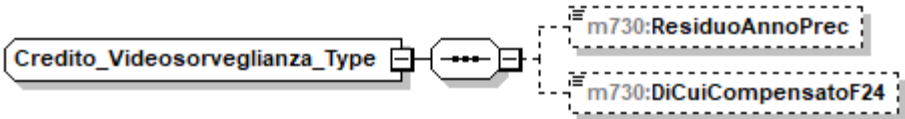
diagram	
children	m730:ResiduoAnnoPrec m730:DiCuiCompensatoF24

element **Credito_Videosorveglianza_Type/ResiduoAnnoPrec**

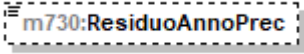
diagram	
type	DatoNP_Type

element **Credito_Videosorveglianza_Type/DiCuiCompensatoF24**

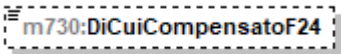
diagram	
type	DatoNP_Type

complexType **Dati_730_Integrativo_Type**

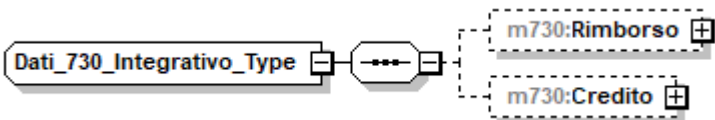
diagram	
children	m730:Rimborso m730:Credito

element **Dati_730_Integrativo_Type/Rimborso**

diagram	
type	m730:Elemento_Integrativo_Type
children	m730:Irpef m730:AddizionaleRegionaleIrpef m730:AddComunaleIrpef m730:CedolareSecca

element **Dati_730_Integrativo_Type/Credito**

diagram	
type	m730:Elemento_Integrativo_Type
children	m730:Irpef m730:AddizionaleRegionaleIrpef m730:AddComunaleIrpef m730:CedolareSecca

complexType **Dati_Altre_Detrazioni_Modulo_Type**

diagram	
children	m730:AltreDetrazioni

element **Dati_Altre_Detrazioni_Modulo_Type/AltreDetrazioni**

diagram	
type	m730:Altre_Detrazioni_Type

children	m730:Codice m730:Importo
----------	--

complexType **Dati_Altre_Detrazioni_Type**

diagram	
children	m730:SpeseCaniGuida m730:AltreDetrazioni

element **Dati_Altre_Detrazioni_Type/SpeseCaniGuida**

diagram	
type	DatoCB_Type

element **Dati_Altre_Detrazioni_Type/AltreDetrazioni**

diagram	
type	m730:Altre_Detrazioni_Type
children	m730:Codice m730:Importo

complexType **Dati_Associazioni_Professionale_Type**

diagram	
children	m730:CFAssociazione m730:DenominazioneAssociazione m730:CFProfessionista m730:CognomeProfessionista m730:NomeProfessionista

element **Dati_Associazioni_Professionale_Type/CFAssociazione**

diagram	
type	DatoCN_Type

element **Dati_Associazioni_Professionale_Type/DenominazioneAssociazione**

diagram	
type	DatoAN_Type

element **Dati_Associazioni_Professionale_Type/CFProfessionista**

diagram	
type	DatoCF_Type

element **Dati_Associazioni_Professionale_Type/CognomeProfessionista**

diagram	
type	DatoAN_Type

element **Dati_Associazioni_Professionale_Type/NomeProfessionista**

diagram	
type	DatoAN_Type

complexType **Dati_CAF_Type**

diagram	
children	m730:CFCaf m730:DenominazioneCaf m730:NumeroAlbo

element **Dati_CAF_Type/CFCaf**

diagram	
---------	--

type	DatoCN_Type
------	-----------------------------

element **Dati_CAF_Type/DenominazioneCaf**

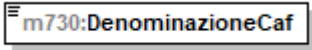
diagram	
type	DatoAN_Type

element **Dati_CAF_Type/NumeroAlbo**

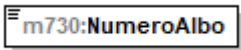
diagram	
type	restriction of DatoNP_Type

complexType **Dati_Catastali_Recupero_Patrimonio_Edilizio_Type**

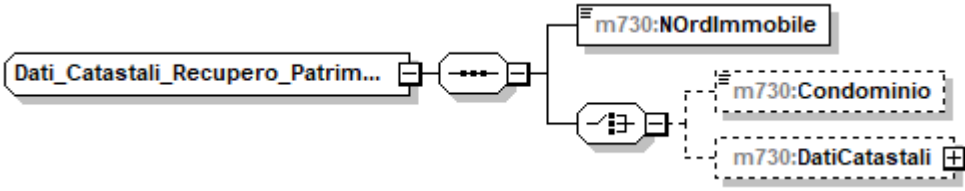
diagram	
children	m730:NOrdImmobilabile m730:Condominio m730:DatiCatastali

element **Dati_Catastali_Recupero_Patrimonio_Edilizio_Type/NOrdImmobilabile**

diagram	
type	DatoNP_Type

element **Dati_Catastali_Recupero_Patrimonio_Edilizio_Type/Condominio**

diagram	
type	DatoCB_Type

element **Dati_Catastali_Recupero_Patrimonio_Edilizio_Type/DatiCatastali**

<p>diagram</p>	<pre> classDiagram class m730DatiCatastali class m730Dati_Catastali_Type class m730CodiceComune class m730TerreniUrbano class m730SezioneUrbanaComuneCa... class m730Foglio class m730Particella class m730Subalterno m730DatiCatastali "1" *-- "1" m730Dati_Catastali_Type m730Dati_Catastali_Type "1" *-- "1" m730CodiceComune m730Dati_Catastali_Type "1" *-- "1" m730TerreniUrbano m730Dati_Catastali_Type "1" *-- "1" m730SezioneUrbanaComuneCa... m730Dati_Catastali_Type "1" *-- "1" m730Foglio m730Dati_Catastali_Type "1" *-- "1" m730Particella m730Dati_Catastali_Type "1" *-- "1" m730Subalterno </pre>
<p>type</p>	<p>m730:Dati_Catastali_Type</p>
<p>children</p>	<p>m730:CodiceComune m730:TerreniUrbano m730:SezioneUrbanaComuneCatastale m730:Foglio m730:Particella m730:Subalterno</p>

complexType **Dati_Catastali_Type**

<p>diagram</p>	<pre> classDiagram class Dati_Catastali_Type class m730CodiceComune class m730TerreniUrbano class m730SezioneUrbanaComuneCa... class m730Foglio class m730Particella class m730Subalterno Dati_Catastali_Type "1" *-- "1" m730CodiceComune Dati_Catastali_Type "1" *-- "1" m730TerreniUrbano Dati_Catastali_Type "1" *-- "1" m730SezioneUrbanaComuneCa... Dati_Catastali_Type "1" *-- "1" m730Foglio Dati_Catastali_Type "1" *-- "1" m730Particella Dati_Catastali_Type "1" *-- "1" m730Subalterno </pre>
<p>children</p>	<p>m730:CodiceComune m730:TerreniUrbano m730:SezioneUrbanaComuneCatastale m730:Foglio m730:Particella m730:Subalterno</p>

element **Dati_Catastali_Type/CodiceComune**

<p>diagram</p>	<pre> classDiagram class m730CodiceComune </pre>
<p>type</p>	<p>DatoAN_Type</p>

element **Dati_Catastali_Type/TerreniUrbano**

<p>diagram</p>	<pre> classDiagram class m730TerreniUrbano </pre>
----------------	---

type	m730:Terreni Urbano Type						
facets	<table border="1"> <thead> <tr> <th>Kind</th> <th>Value</th> </tr> </thead> <tbody> <tr> <td>enumeration</td> <td>T</td> </tr> <tr> <td>enumeration</td> <td>U</td> </tr> </tbody> </table>	Kind	Value	enumeration	T	enumeration	U
Kind	Value						
enumeration	T						
enumeration	U						

element **Dati_Catastali_Type/SezioneUrbanaComuneCatastale**

diagram	
type	DatoAN_Type

element **Dati_Catastali_Type/Foglio**

diagram	
type	DatoAN_Type

element **Dati_Catastali_Type/Particella**

diagram	
children	m730:Numeratore m730:Denominatore

element **Dati_Catastali_Type/Particella/Numeratore**

diagram	
type	DatoAN_Type

element **Dati_Catastali_Type/Particella/Denominatore**

diagram	
type	DatoAN_Type

element **Dati_Catastali_Type/Subalterno**

diagram	
type	DatoAN_Type

complexType Dati_Condominio_Type

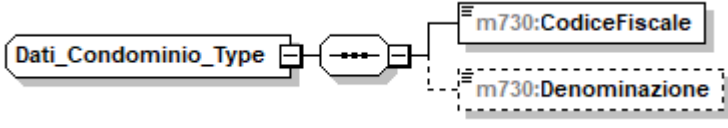
diagram	
children	m730:CodiceFiscale m730:Denominazione

element Dati_Condominio_Type/CodiceFiscale

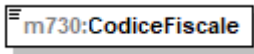
diagram	
type	DatoCF_Type

element Dati_Condominio_Type/Denominazione

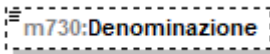
diagram	
type	DatoAN_Type

complexType Dati_Coniuge_Type

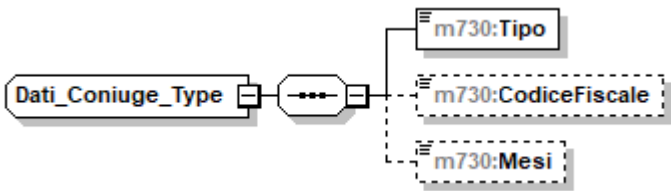
diagram	
children	m730:Tipo m730:CodiceFiscale m730:Mesi

element Dati_Coniuge_Type/Tipo

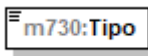
diagram	
type	DatoCB_Type

element Dati_Coniuge_Type/CodiceFiscale

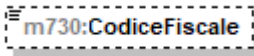
diagram	
type	DatoCF_Type

element **Dati_Coniuge_Type/Mesi**

diagram		
type	m730:Mesi_Type	
facets	Kind	Value
	enumeration	1
	enumeration	2
	enumeration	3
	enumeration	4
	enumeration	5
	enumeration	6
	enumeration	7
	enumeration	8
	enumeration	9
	enumeration	10
	enumeration	11
	enumeration	12

complexType **Dati_Contabili_Type**

diagram		
children	m730:Familiari m730:QuadroA m730:QuadroB m730:QuadroC m730:QuadroD m730:QuadroE m730:QuadroF m730:QuadroG m730:QuadroI m730:ProspettoLiquidazione m730:Prospetto_Annotazioni m730:QuadroK m730:QuadroL m730:QuadroW	

element **Dati Contabili Type/Familiari**

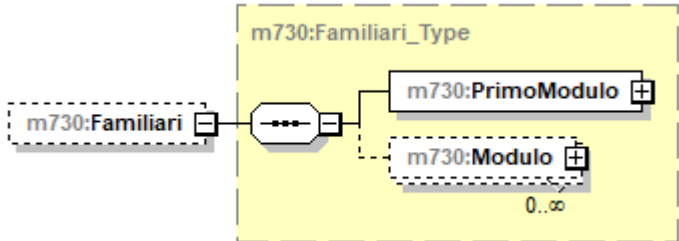
diagram	 <p>The diagram shows a dashed box labeled 'm730:Familiari_Type'. Inside, there is a dashed box labeled 'm730:Familiari'. To the right of 'm730:Familiari' is a connector symbol (a hexagon with three dots). This connector is connected to two boxes: 'm730:PrimoModulo' and 'm730:Modulo'. The 'm730:Modulo' box has a multiplicity of '0..∞' below it.</p>
type	m730:Familiari_Type
children	m730:PrimoModulo m730:Modulo

element **Dati Contabili Type/QuadroA**

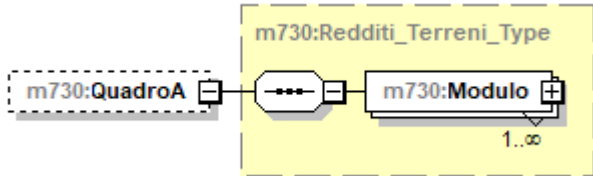
diagram	 <p>The diagram shows a dashed box labeled 'm730:Redditi_Terreni_Type'. Inside, there is a dashed box labeled 'm730:QuadroA'. To the right of 'm730:QuadroA' is a connector symbol (a hexagon with three dots). This connector is connected to a box labeled 'm730:Modulo'. The 'm730:Modulo' box has a multiplicity of '1..∞' below it.</p>
type	m730:Redditi_Terreni_Type
children	m730:Modulo

element **Dati Contabili Type/QuadroB**

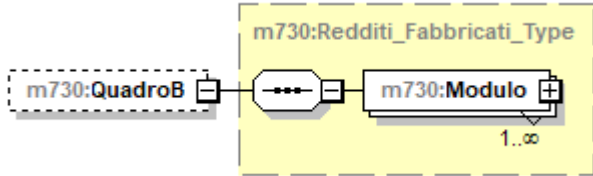
diagram	 <p>The diagram shows a dashed box labeled 'm730:Redditi_Fabbricati_Type'. Inside, there is a dashed box labeled 'm730:QuadroB'. To the right of 'm730:QuadroB' is a connector symbol (a hexagon with three dots). This connector is connected to a box labeled 'm730:Modulo'. The 'm730:Modulo' box has a multiplicity of '1..∞' below it.</p>
type	m730:Redditi_Fabbricati_Type
children	m730:Modulo

element **Dati Contabili Type/QuadroC**

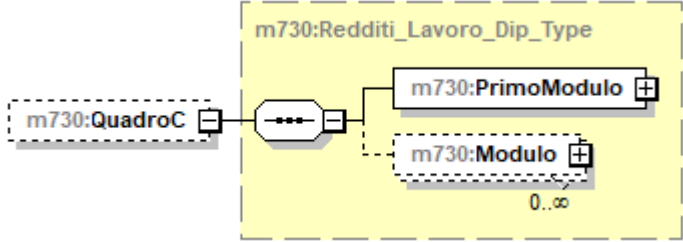
diagram	 <p>The diagram shows a dashed box labeled 'm730:Redditi_Lavoro_Dip_Type'. Inside, there is a dashed box labeled 'm730:QuadroC'. To the right of 'm730:QuadroC' is a connector symbol (a hexagon with three dots). This connector is connected to two boxes: 'm730:PrimoModulo' and 'm730:Modulo'. The 'm730:Modulo' box has a multiplicity of '0..∞' below it.</p>
type	m730:Redditi_Lavoro_Dip_Type
children	m730:PrimoModulo m730:Modulo

element **Dati_Contabili_Type/QuadroD**

diagram	
type	extension of m730:Altri_Reddito_Type
children	m730:Modulo

element **Dati_Contabili_Type/QuadroE**

diagram	
type	m730:Oneri_Type
children	m730:PrimoModulo m730:Modulo

element **Dati_Contabili_Type/QuadroF**

diagram	
type	m730:Acconti_Ritenute_Type
children	m730:PrimoModulo m730:Modulo

element **Dati Contabili Type/QuadroG**

diagram	
type	m730:Crediti Imposta Type
children	m730:PrimoModulo m730:Modulo

element **Dati Contabili Type/Quadrol**

diagram	
type	extension of m730:Quadro I Type
children	m730:UtilizzoF24 m730:UtilizzoF24Sost

element **Dati Contabili Type/ProspettoLiquidazione**

diagram	
type	m730:Prospetto Liquidazione Type
children	m730:PrimoModulo m730:Modulo

element **Dati Contabili Type/Prospetto Annotazioni**

diagram	
type	m730:Prospetto Annotazioni Type

children	m730:Modulo Annotazioni
----------	---

element **Dati Contabili Type/QuadroK**

diagram	
type	m730:Comunicazione Amministratore Type
children	m730:Modulo

element **Dati Contabili Type/QuadroL**

diagram	
type	m730:Ulteriori Dati Type
children	m730:Modulo

element **Dati Contabili Type/QuadroW**

diagram	
type	m730:Investimenti Estero Type
children	m730:PrimoModulo m730:Modulo

complexType **Dati_Contratto_Type**

diagram	
children	m730:DataRegContratto m730:SerieContratto m730:NumeroContratto m730:Sottonumero m730:CodiceUfficio m730:IdentificativoContratto

element **Dati_Contratto_Type/DataRegContratto**

diagram	
type	DatoDT_Type

element **Dati_Contratto_Type/SerieContratto**

diagram															
type	m730:Serie_Registrazione_Contratto_Type														
facets	<table border="1"> <thead> <tr> <th>Kind</th> <th>Value</th> </tr> </thead> <tbody> <tr> <td>enumeration</td> <td>3</td> </tr> <tr> <td>enumeration</td> <td>3A</td> </tr> <tr> <td>enumeration</td> <td>3B</td> </tr> <tr> <td>enumeration</td> <td>3P</td> </tr> <tr> <td>enumeration</td> <td>1T</td> </tr> <tr> <td>enumeration</td> <td>3T</td> </tr> </tbody> </table>	Kind	Value	enumeration	3	enumeration	3A	enumeration	3B	enumeration	3P	enumeration	1T	enumeration	3T
Kind	Value														
enumeration	3														
enumeration	3A														
enumeration	3B														
enumeration	3P														
enumeration	1T														
enumeration	3T														

element **Dati_Contratto_Type/NumeroContratto**

diagram	
type	DatoAN_Type

element **Dati_Contratto_Type/Sottonumero**

diagram	
type	DatoAN_Type

element **Dati_Contratto_Type/CodiceUfficio**

diagram	
type	restriction of DatoAN_Type

element **Dati_Contratto_Type/IdentificativoContratto**

diagram	
type	DatoAN_Type

complexType **Dati_F24_Type**

diagram	
children	m730:Credito m730:Debito m730:PrimaRataAcconto m730:SecondaRataAcconto

element **Dati_F24_Type/Credito**

diagram	
type	DatoNP_Type

element **Dati_F24_Type/Debito**

diagram	
type	DatoNP_Type

element **Dati_F24_Type/PrimaRataAcconto**

diagram	
type	DatoNP_Type

element **Dati_F24_Type/SecondaRataAcconto**

diagram	
type	DatoNP_Type

complexType **Dati_Familiare_Type**

diagram	
children	m730:CodiceFiscale m730:Mesì m730:PercDetraz m730:PercDetrazCon m730:Affidamento m730:MesìDetraz21Anni

element **Dati_Familiare_Type/CodiceFiscale**

diagram	
type	DatoCF_Type

element **Dati_Familiare_Type/Mesì**

diagram	
type	DatoNP_Type

element **Dati_Familiare_Type/PercDetraz**

diagram	
type	DatoPC_Type

element **Dati_Familiare_Type/PercDetrazCon**

diagram	
type	DatoAN_Type

element **Dati_Familiare_Type/Affidamento**

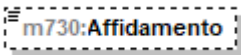
diagram	
type	DatoCB_Type

element **Dati_Familiare_Type/MesiDetraz21Anni**

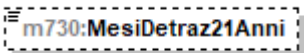
diagram	
type	DatoNP_Type

complexType **Dati_Fornitore_Type**

diagram	 <p>The diagram shows the complex type Dati_Fornitore_Type on the left, connected to a container box. This container box is linked to a vertical list of child elements, each in a dashed box: m730:CodiceFiscale, m730:CognomeDenom, m730:Nome, m730:Sesso, m730:DataNascita, m730:ComuneNascita, m730:ProvinciaNascita, m730:ImportoAcquisti, and m730:StatoEstero.</p>
children	m730:CodiceFiscale m730:CognomeDenom m730:Nome m730:Sesso m730:DataNascita m730:ComuneNascita m730:ProvinciaNascita m730:ImportoAcquisti m730:StatoEstero

element **Dati_Fornitore_Type/CodiceFiscale**

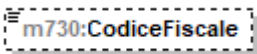
diagram	
type	DatoCF_Type

element **Dati_Fornitore_Type/CognomeDenom**

diagram	
---------	---

type	DatoAN_Type
------	-----------------------------

element **Dati_Fornitore_Type/Nome**

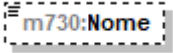
diagram	 A diagram showing a dashed rectangular box containing the text "m730:Nome". To the left of the box is a small icon consisting of three horizontal lines of decreasing length, resembling a list or menu symbol.
type	DatoAN_Type

element **Dati_Fornitore_Type/Sesso**

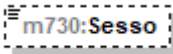
diagram	 A diagram showing a dashed rectangular box containing the text "m730:Sesso". To the left of the box is a small icon consisting of three horizontal lines of decreasing length, resembling a list or menu symbol.								
type	Sesso_Type								
facets	<table border="0"> <tr> <td>Kind</td> <td>enumeration</td> <td>Value</td> <td>M</td> </tr> <tr> <td></td> <td>enumeration</td> <td></td> <td>F</td> </tr> </table>	Kind	enumeration	Value	M		enumeration		F
Kind	enumeration	Value	M						
	enumeration		F						

element **Dati_Fornitore_Type/DataNascita**

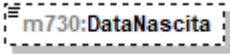
diagram	 A diagram showing a dashed rectangular box containing the text "m730:DataNascita". To the left of the box is a small icon consisting of three horizontal lines of decreasing length, resembling a list or menu symbol.
type	DatoDT_Type

element **Dati_Fornitore_Type/ComuneNascita**

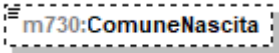
diagram	 A diagram showing a dashed rectangular box containing the text "m730:ComuneNascita". To the left of the box is a small icon consisting of three horizontal lines of decreasing length, resembling a list or menu symbol.
type	DatoAN_Type

element **Dati_Fornitore_Type/ProvinciaNascita**

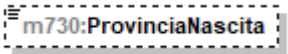
diagram	 A diagram showing a dashed rectangular box containing the text "m730:ProvinciaNascita". To the left of the box is a small icon consisting of three horizontal lines of decreasing length, resembling a list or menu symbol.
type	PN_Type

element **Dati_Fornitore_Type/ImportoAcquisti**

diagram	 A diagram showing a dashed rectangular box containing the text "m730:ImportoAcquisti". To the left of the box is a small icon consisting of three horizontal lines of decreasing length, resembling a list or menu symbol.
type	DatoNP_Type

element **Dati_Fornitore_Type/StatoEstero**

diagram	
type	DatoAN_Type

complexType **Dati_Nascita_PF_Type**

diagram	
children	m730:Sesso m730:DataNascita m730:ComuneNascita m730:ProvinciaNascita

element **Dati_Nascita_PF_Type/Sesso**

diagram										
type	Sesso_Type									
facets	<table border="0"> <tr> <td>Kind</td> <td>enumeration</td> <td>Value</td> </tr> <tr> <td></td> <td>enumeration</td> <td>M</td> </tr> <tr> <td></td> <td>enumeration</td> <td>F</td> </tr> </table>	Kind	enumeration	Value		enumeration	M		enumeration	F
Kind	enumeration	Value								
	enumeration	M								
	enumeration	F								

element **Dati_Nascita_PF_Type/DataNascita**

diagram	
type	DatoDT_Type

element **Dati_Nascita_PF_Type/ComuneNascita**

diagram	
type	DatoAN_Type

element **Dati_Nascita_PF_Type/ProvinciaNascita**

diagram	
type	PN_Type

complexType **Dati_Primo_Figlio_Type**

diagram	
children	m730:Tipo m730:CodiceFiscale m730:Mesi m730:MesiMinore m730:PercDetraz m730:Affidamento

element **Dati_Primo_Figlio_Type/Tipo**

diagram							
type	restriction of DatoAN_Type						
facets	<table border="1"> <thead> <tr> <th>Kind</th> <th>Value</th> </tr> </thead> <tbody> <tr> <td>enumeration</td> <td>F</td> </tr> <tr> <td>enumeration</td> <td>D</td> </tr> </tbody> </table>	Kind	Value	enumeration	F	enumeration	D
Kind	Value						
enumeration	F						
enumeration	D						

element **Dati_Primo_Figlio_Type/CodiceFiscale**

diagram	
type	DatoCF_Type

element **Dati_Primo_Figlio_Type/Mesi**

diagram																											
type	m730:Mesi_Type																										
facets	<table border="1"> <thead> <tr> <th>Kind</th> <th>Value</th> </tr> </thead> <tbody> <tr><td>enumeration</td><td>1</td></tr> <tr><td>enumeration</td><td>2</td></tr> <tr><td>enumeration</td><td>3</td></tr> <tr><td>enumeration</td><td>4</td></tr> <tr><td>enumeration</td><td>5</td></tr> <tr><td>enumeration</td><td>6</td></tr> <tr><td>enumeration</td><td>7</td></tr> <tr><td>enumeration</td><td>8</td></tr> <tr><td>enumeration</td><td>9</td></tr> <tr><td>enumeration</td><td>10</td></tr> <tr><td>enumeration</td><td>11</td></tr> <tr><td>enumeration</td><td>12</td></tr> </tbody> </table>	Kind	Value	enumeration	1	enumeration	2	enumeration	3	enumeration	4	enumeration	5	enumeration	6	enumeration	7	enumeration	8	enumeration	9	enumeration	10	enumeration	11	enumeration	12
Kind	Value																										
enumeration	1																										
enumeration	2																										
enumeration	3																										
enumeration	4																										
enumeration	5																										
enumeration	6																										
enumeration	7																										
enumeration	8																										
enumeration	9																										
enumeration	10																										
enumeration	11																										
enumeration	12																										

element **Dati_Primo_Figlio_Type/MesiMinore**

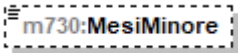
diagram																											
type	m730:Mesi_Type																										
facets	<table border="1"> <thead> <tr> <th>Kind</th> <th>Value</th> </tr> </thead> <tbody> <tr><td>enumeration</td><td>1</td></tr> <tr><td>enumeration</td><td>2</td></tr> <tr><td>enumeration</td><td>3</td></tr> <tr><td>enumeration</td><td>4</td></tr> <tr><td>enumeration</td><td>5</td></tr> <tr><td>enumeration</td><td>6</td></tr> <tr><td>enumeration</td><td>7</td></tr> <tr><td>enumeration</td><td>8</td></tr> <tr><td>enumeration</td><td>9</td></tr> <tr><td>enumeration</td><td>10</td></tr> <tr><td>enumeration</td><td>11</td></tr> <tr><td>enumeration</td><td>12</td></tr> </tbody> </table>	Kind	Value	enumeration	1	enumeration	2	enumeration	3	enumeration	4	enumeration	5	enumeration	6	enumeration	7	enumeration	8	enumeration	9	enumeration	10	enumeration	11	enumeration	12
Kind	Value																										
enumeration	1																										
enumeration	2																										
enumeration	3																										
enumeration	4																										
enumeration	5																										
enumeration	6																										
enumeration	7																										
enumeration	8																										
enumeration	9																										
enumeration	10																										
enumeration	11																										
enumeration	12																										

element **Dati_Primo_Figlio_Type/PercDetraz**

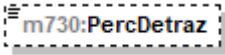
diagram	
type	DatoPC_Type

element **Dati_Primo_Figlio_Type/Affidamento**

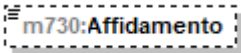
diagram	
type	DatoCB_Type

complexType **Dati_Professionista_Type**

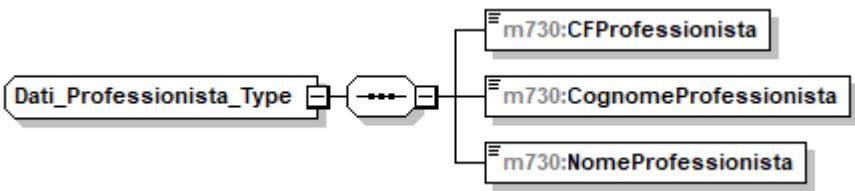
diagram	
children	m730:CFProfessionista m730:CognomeProfessionista m730:NomeProfessionista

element **Dati_Professionista_Type/CFProfessionista**

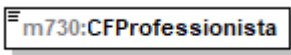
diagram	
type	DatoCF_Type

element **Dati_Professionista_Type/CognomeProfessionista**

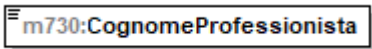
diagram	
type	DatoAN_Type

element **Dati_Professionista_Type/NomeProfessionista**

diagram	
type	DatoAN_Type

complexType **Dati_Registrazione_Accatastamento_Recupero_Patrimonio_Edilizio_Type**

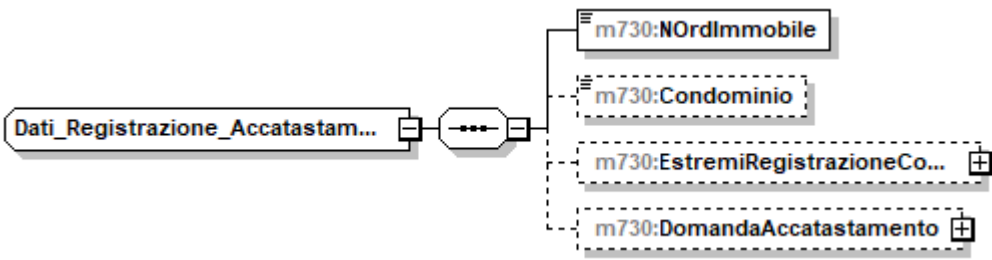
diagram	
children	m730:NOrdImmobile m730:Condominio m730:EstremiRegistrazioneContratto m730:DomandaAccatastamento

element **Dati_Registrazione_Accatastamento_Recupero_Patrimonio_Edilizio_Type/NOrdImmobile**

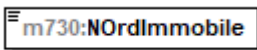
diagram	
type	DatoNP_Type

element **Dati_Registrazione_Accatastamento_Recupero_Patrimonio_Edilizio_Type/Condominio**

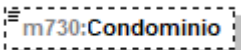
diagram	
type	DatoCB_Type

element

Dati_Registrazione_Accatastamento_Recupero_Patrimonio_Edilizio_Type/EstremiRegistrazioneContra

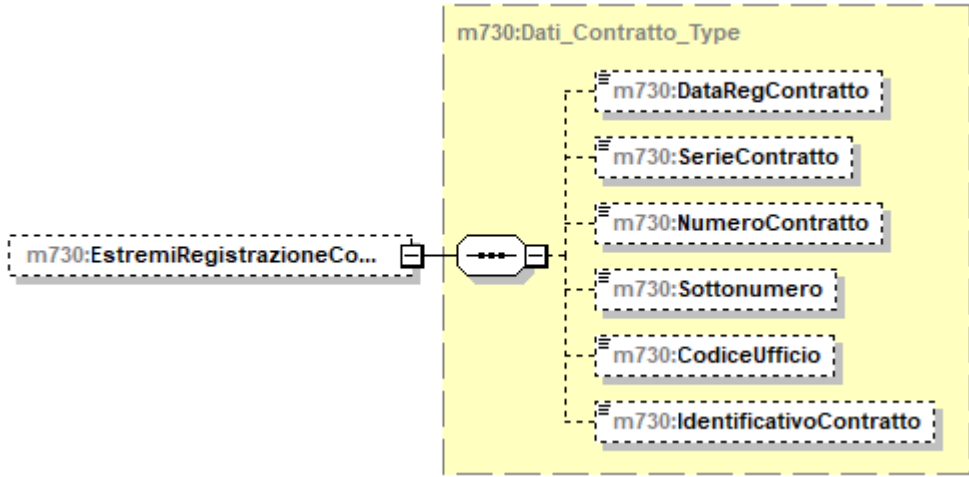
diagram	
type	m730:Dati_Contratto_Type
children	m730:DataRegContratto m730:SerieContratto m730:NumeroContratto m730:Sottonumero m730:CodiceUfficio m730:IdentificativoContratto

element

Dati_Registrazione_Accatastamento_Recupero_Patrimonio_Edilizio_Type/DomandaAccatastamento

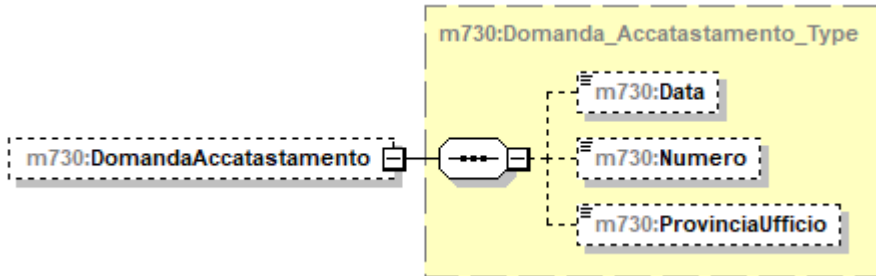
diagram	
type	m730:Domanda_Accatastamento_Type
children	m730:Data m730:Numero m730:ProvinciaUfficio

complexType Dati_Rettificati_Type

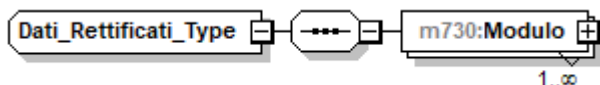
diagram	
children	m730:Modulo

element **Dati_Rettificati_Type/Modulo**

diagram	
type	m730:Modulo Dati Rettificati Type
children	m730:Rettifica

complexType **Debito_Type**

diagram	
children	m730:NonVersare m730:ImportoDaTrattenere

element **Debito_Type/NonVersare**

diagram	
type	DatoNP_Type

element **Debito_Type/ImportoDaTrattenere**

diagram	
type	DatoNP_Type

complexType **Deduzioni_Modulo_Type**

diagram	
children	m730:AssegnoConiuge m730:AltriOneri m730:AcquistoCostruzioneAbitLocazione

element **Deduzioni_Modulo_Type/AssegnoConiuge**

diagram	
type	m730:Assegno_Coniuge_Type
children	m730:CodiceFiscale m730:Importo

element **Deduzioni_Modulo_Type/AltriOneri**

diagram	
type	m730:Altri_Oneri_Type
children	m730:Codice m730:Importo

element **Deduzioni_Modulo_Type/AcquistoCostruzioneAbitLocazione**

diagram	
type	m730:Acquisto_Costruzione_Abit_Type
children	m730:DataStipula m730:Spesa m730:InteressiMutuo

complexType **Deduzioni_Type**

<p>diagram</p>	
<p>children</p>	<p>m730:ContributiPrevAss m730:AssegnoConiuge m730:ContributiColf m730:ErogazioniIstituzioniReligiose m730:SpesePortatoriHandicap m730:AltriOneri m730:DeducibilitaOrdinaria m730:LavoratoriPrimaOccupazione m730:FondiInSquilibrioFinanziario m730:FamiliariACarico m730:AcquistoCostruzioneAbitLocazione m730:RestituzioneSomme m730:ErogazioniOnlus</p>

element **Deduzioni_Type/ContributiPrevAss**

<p>diagram</p>	
<p>type</p>	<p>DatoNP_Type</p>

element **Deduzioni_Type/AssegnoConiuge**

<p>diagram</p>	
<p>type</p>	<p>m730:Assegno_Coniuge_Type</p>
<p>children</p>	<p>m730:CodiceFiscale m730:Importo</p>

element **Deduzioni_Type/ContributiColf**

diagram	
type	DatoNP_Type

element **Deduzioni_Type/ErogazioniIstituzioniReligiose**

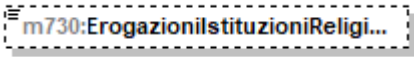
diagram	
type	DatoNP_Type

element **Deduzioni_Type/SpesePortatoriHandicap**

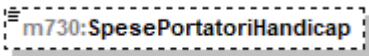
diagram	
type	DatoNP_Type

element **Deduzioni_Type/AltriOneri**

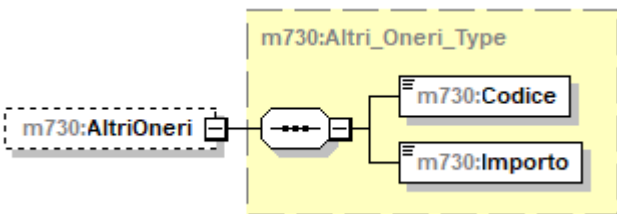
diagram	
type	m730:Altri_Oneri_Type
children	m730:Codice m730:Importo

element **Deduzioni_Type/DeducibilitaOrdinaria**

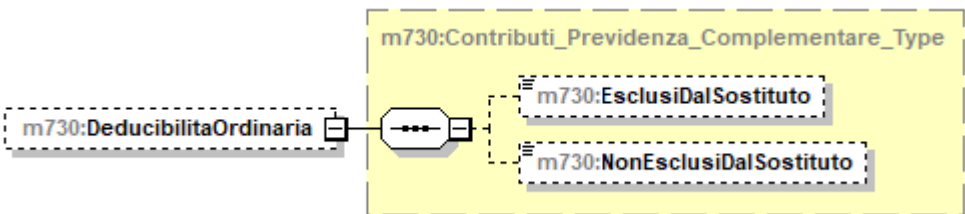
diagram	
type	m730:Contributi_Previdenza_Complementare_Type
children	m730:EsclusiDalSostituto m730:NonEsclusiDalSostituto

element **Deduzioni_Type/LavoratoriPrimaOccupazione**

diagram	
type	m730:Contributi_Previdenza_Complementare_Type
children	m730:EsclusiDalSostituto m730:NonEsclusiDalSostituto

element **Deduzioni_Type/FondiInSquilibrioFinanziario**

diagram	
type	m730:Contributi_Previdenza_Complementare_Type
children	m730:EsclusiDalSostituto m730:NonEsclusiDalSostituto

element **Deduzioni_Type/FamiliariACarico**

diagram	
type	m730:Contributi_Previdenza_Complementare_Type
children	m730:EsclusiDalSostituto m730:NonEsclusiDalSostituto

element **Deduzioni_Type/AcquistoCostruzioneAbitLocazione**

diagram	
---------	--

type	m730:Acquisto Costruzione Abit Type
children	m730:DataStipula m730:Spesa m730:InteressiMutuo

element **Deduzioni_Type/RestituzioneSomme**

diagram	<pre> classDiagram class m730RestituzioneSomme class m730Restituzione_Somme_Type { m730SommeRestituite m730ResiduoPrecedenteDic } m730RestituzioneSomme -- > m730Restituzione_Somme_Type </pre>
type	m730:Restituzione Somme Type
children	m730:SommeRestituite m730:ResiduoPrecedenteDic

element **Deduzioni_Type/ErogazioniOnlus**

diagram	<pre> classDiagram class m730ErogazioniOnlus class m730Erogazioni_Onlus_Type { m730Importo m730ResiduoPrecedenteDic m730ResiduoDueAnniPrecDic m730ResiduoTreAnniPrecDic m730ResiduoQuattroAnniPrecDic } m730ErogazioniOnlus -- > m730Erogazioni_Onlus_Type </pre>
type	m730:Erogazioni Onlus Type
children	m730:Importo m730:ResiduoPrecedenteDic m730:ResiduoDueAnniPrecDic m730:ResiduoTreAnniPrecDic m730:ResiduoQuattroAnniPrecDic

complexType **Detrazione_Crediti_Type**

diagram



children

[m730:DetrazioneConiuge](#) [m730:DetrazioneFigli](#) [m730:DetrazioneFamiliari](#) [m730:DetrazioneLavDip](#)
[m730:DetrazionePens](#) [m730:DetrazioneAltriRedditi](#) [m730:DetrazioneOneri](#) [m730:DetrazioneRistrutturazione](#)
[m730:DetrazioniArredolmmobili](#) [m730:DetrazioneRisparmioEnergetico](#) [m730:DetrazioneArredoGiovaniCoppie](#)

[m730:DetrazioneIvaAcquistoAbitaz](#) [m730:DetrazioneLocEAgricoliGiovani](#) [m730:AltreDetrazioni](#)
[m730:DetrazioneCompartoSicurezza](#) [m730:DetrazionePaceContrRicarica](#) [m730:CreditoPrimaCasa](#)
[m730:CreditoOccupazione](#) [m730:CreditoFondiPensione](#) [m730:CreditoMediazioni](#) [m730:CreditoNegoziazione](#)
[m730:CreditoPrimaCasaU36](#) [m730:CreditoContributoUnificato](#) [m730:TotaleDetrazioniCrediti](#)

element **Detrazione_Crediti_Type/DetrazioneConiuge**

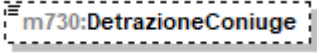
diagram	
type	DatoNP_Type

element **Detrazione_Crediti_Type/DetrazioneFigli**

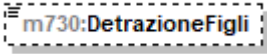
diagram	
type	DatoNP_Type

element **Detrazione_Crediti_Type/DetrazioneFamiliari**

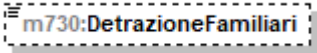
diagram	
type	DatoNP_Type

element **Detrazione_Crediti_Type/DetrazioneLavDip**

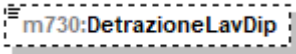
diagram	
type	DatoNP_Type

element **Detrazione_Crediti_Type/DetrazionePens**

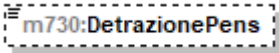
diagram	
type	DatoNP_Type

element **Detrazione_Crediti_Type/DetrazioneAltriRedditi**

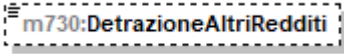
diagram	
type	DatoNP_Type

element **Detrazione_Crediti_Type/DetrazioneOneri**

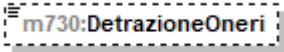
diagram	
type	DatoNP_Type

element **Detrazione_Crediti_Type/DetrazioneRistrutturazione**

diagram	
type	DatoNP_Type

element **Detrazione_Crediti_Type/DetrazioniArredolmmobili**

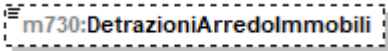
diagram	
type	DatoNP_Type

element **Detrazione_Crediti_Type/DetrazioneRisparmioEnergetico**

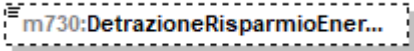
diagram	
type	DatoNP_Type

element **Detrazione_Crediti_Type/DetrazioneArredoGiovaniCoppie**

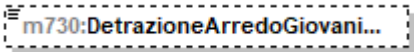
diagram	
type	DatoNP_Type

element **Detrazione_Crediti_Type/DetrazioneIvaAcquistoAbitaz**

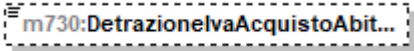
diagram	
type	DatoNP_Type

element **Detrazione_Crediti_Type/DetrazioneLocEAgricoliGiovani**

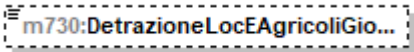
diagram	
type	DatoNP_Type

element **Detrazione_Crediti_Type/AltreDetrazioni**

diagram	
type	DatoNP_Type

element **Detrazione_Crediti_Type/DetrazioneCompartoSicurezza**

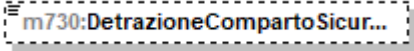
diagram	
type	DatoNP_Type

element **Detrazione_Crediti_Type/DetrazionePaceContrRicarica**

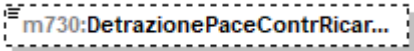
diagram	
type	DatoNP_Type

element **Detrazione_Crediti_Type/CreditoPrimaCasa**

diagram	
type	DatoNP_Type

element **Detrazione_Crediti_Type/CreditoOccupazione**

diagram	
type	DatoNP_Type

element **Detrazione_Crediti_Type/CreditoFondiPensione**

diagram	
type	DatoNP_Type

element **Detrazione_Crediti_Type/CreditoMediazioni**

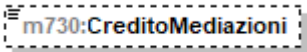
diagram	
type	DatoNP_Type

element **Detrazione_Crediti_Type/CreditoNegoziazione**

diagram	
type	DatoNP_Type

element **Detrazione_Crediti_Type/CreditoPrimaCasaU36**

diagram	
type	DatoNP_Type

element **Detrazione_Crediti_Type/CreditoContributoUnificato**

diagram	
type	DatoNP_Type

element **Detrazione_Crediti_Type/TotaleDetrazioniCrediti**

diagram	
type	DatoNP_Type

complexType **Detrazioni_Canoni_Locazione_Type**

diagram	
children	m730:InquiliniAbitazionePrincipale m730:DipendentiTrasferiti

element **Detrazioni_Canoni_Locazione_Type/InquiliniAbitazionePrincipale**

diagram	
type	m730:Inquilini_Abitazione_Principale_Type
children	m730:Tipologia m730:GiorniPercentuale m730:Canone

element **Detrazioni_Canoni_Locazione_Type/DipendentiTrasferiti**

diagram	
type	m730:Giorni_Percentuale_Type
children	m730:Giorni m730:Percentuale

complexType **Detrazioni_Modulo_Type**

diagram	
children	m730:VeicoliDisabili m730:AcquistoCaniGuida m730:SpeseRateizzate m730:AltreSpese m730:SpeseLeasing

element **Detrazioni_Modulo_Type/VeicoliDisabili**

diagram	
type	m730:Spese_Rateizzate_Type
children	m730:Codice m730:Importo

element **Detrazioni_Modulo_Type/AcquistoCaniGuida**

diagram	
type	m730:Spese_Rateizzate_Type
children	m730:Codice m730:Importo

element **Detrazioni_Modulo_Type/SpeseRateizzate**

diagram	
type	m730:Spese_Rateizzate_Anni_Precedenti_Type
children	m730:Codice m730:Importo

element **Detrazioni_Modulo_Type/AltreSpese**

diagram	
type	m730:Altre_Spese_Type
children	m730:Codice m730:Importo

element **Detrazioni_Modulo_Type/SpeseLeasing**

diagram	
type	m730:Spese_Leasing_Type
children	m730:DataStipula m730:NumeroAnno m730:Canone m730:PrezzoRiscatto

complexType **Detrazioni_Type**

diagram	
children	m730:CasellaRateazione m730:SpeseDeterminatePatologie m730:SpeseSanitarie m730:SpeseFamNonACarico m730:SpeseSanitarieDisabili m730:VeicoliDisabili m730:AcquistoCaniGuida m730:SpeseRateizzate m730:MutuiAbPrincipaleAnte m730:MutuiAbPrincipalePost m730:AltreSpese m730:SpeseLeasing

element **Detrazioni_Type/CasellaRateazione**

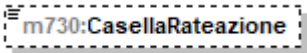
diagram	
type	DatoCB_Type

element **Detrazioni_Type/SpeseDeterminatePatologie**

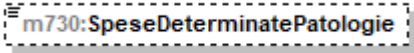
diagram	
type	DatoNP_Type

element **Detrazioni_Type/SpeseSanitarie**

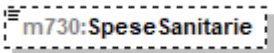
diagram	
type	DatoNP_Type

element **Detrazioni_Type/SpeseFamNonACarico**

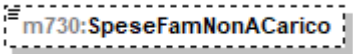
diagram	
type	DatoNP_Type

element **Detrazioni_Type/SpeseSanitarieDisabili**

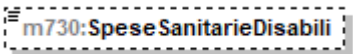
diagram	
type	DatoNP_Type

element **Detrazioni_Type/VeicoliDisabili**

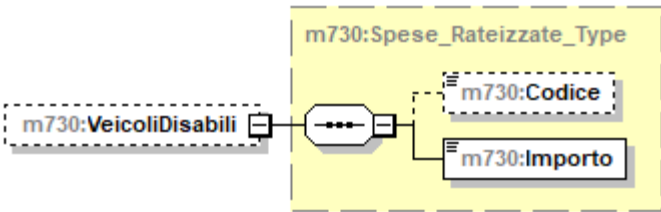
diagram	
type	m730:Spese_Rateizzate_Type
children	m730:Codice m730:Importo

element **Detrazioni_Type/AcquistoCaniGuida**

diagram	<p>The diagram shows a dashed box labeled 'm730:AcquistoCaniGuida' connected to a larger dashed box labeled 'm730:Spese_Rateizzate_Type'. Inside the larger box, there are two smaller boxes: 'm730:Codice' and 'm730:Importo'.</p>
type	m730:Spese_Rateizzate_Type
children	m730:Codice m730:Importo

element **Detrazioni_Type/SpeseRateizzate**

diagram	<p>The diagram shows a dashed box labeled 'm730:SpeseRateizzate' connected to a larger dashed box labeled 'm730:Spese_Rateizzate_Anni_Precedenti_Type'. Inside the larger box, there are two smaller boxes: 'm730:Codice' and 'm730:Importo'.</p>
type	m730:Spese_Rateizzate_Anni_Precedenti_Type
children	m730:Codice m730:Importo

element **Detrazioni_Type/MutuiAbPrincipaleAnte**

diagram	<p>The diagram shows a dashed box labeled 'm730:MutuiAbPrincipaleAnte'.</p>
type	DatoNP_Type

element **Detrazioni_Type/MutuiAbPrincipalePost**

diagram	<p>The diagram shows a dashed box labeled 'm730:MutuiAbPrincipalePost'.</p>
type	DatoNP_Type

element **Detrazioni_Type/AltreSpese**

diagram	<p>The diagram shows a dashed box labeled 'm730:AltreSpese' with '0..3' below it, connected to a larger dashed box labeled 'm730:Altre_Spese_Type'. Inside the larger box, there are two smaller boxes: 'm730:Codice' and 'm730:Importo'.</p>
type	m730:Altre_Spese_Type

children	m730:Codice m730:Importo
----------	--

element **Detrazioni_Type/SpeseLeasing**

diagram	<p>The diagram shows a dashed box labeled 'm730:Spese_Leasing_Type' containing four elements: 'm730:DataStipula', 'm730:NumeroAnno', 'm730:Canone', and 'm730:PrezzoRiscatto'. To the left, a solid box labeled 'm730:SpeseLeasing' is connected to the main structure by a line with a small square at the end.</p>
type	m730:Spese_Leasing_Type
children	m730:DataStipula m730:NumeroAnno m730:Canone m730:PrezzoRiscatto

complexType **Dichiarazione_Con_Type**

diagram	<p>The diagram shows a solid box labeled 'Dichiarazione_Con_Type' connected to a central structure. This structure branches into four elements: 'm730:Frontespizio', 'm730:DatiContabili', 'm730:FuoriAssistenzaQuadri', and 'm730:Scelte'. The first two elements are in solid boxes, while the last two are in dashed boxes. Each element has a small square icon with a plus sign.</p>
children	m730:Frontespizio m730:DatiContabili m730:FuoriAssistenzaQuadri m730:Scelte

element **Dichiarazione_Con_Type/Frontespizio**

<p>diagram</p>	
<p>type</p>	<p>m730:Frontespizio_Con_Type</p>
<p>children</p>	<p>m730:SoggettoFiscale m730:DatiAnagrafici m730:StatoCivile m730:ResidenzaAnagrafica m730:DomicilioFiscaleSaldo m730:DomicilioFiscaleAcconto m730:CasiParticolariAddizionale m730:Firma</p>

element **Dichiarazione_Con_Type/DatiContabili**

<p>diagram</p>	<pre> classDiagram class m730DatiContabili class m730DatiContabili_Type { m730Familiari m730QuadroA m730QuadroB m730QuadroC m730QuadroD m730QuadroE m730QuadroF m730QuadroG m730QuadroI m730ProspettoLiquidazione m730Prospetto_Annotazioni m730QuadroK m730QuadroL m730QuadroW } m730DatiContabili -- m730DatiContabili_Type </pre>
<p>type</p>	<p>m730:Dati_Contabili_Type</p>
<p>children</p>	<p>m730:Familiari m730:QuadroA m730:QuadroB m730:QuadroC m730:QuadroD m730:QuadroE m730:QuadroF m730:QuadroG m730:QuadroI m730:ProspettoLiquidazione m730:Prospetto_Annotazioni m730:QuadroK m730:QuadroL m730:QuadroW</p>

element **Dichiarazione_Con_Type/FuoriAssistenzaQuadri**

diagram	
type	m730:Fuori_Assistenza_Type
children	m730:AnomaliaDatianagrafici m730:AnomaliaTerreni m730:AnomaliaFabbricati m730:AnomaliaLavDip m730:AnomaliaAltriRedditi m730:AnomaliaQuadroF

element **Dichiarazione_Con_Type/Scelte**

diagram	
type	sce:Scelte_Type
children	sce:Scelta5PerMille sce:Scelta8PerMille sce:Scelta2PerMille

complexType **Dichiarazione_Dich_Type**

diagram	
children	m730:Frontespizio m730:DatiContabili m730:FuoriAssistenza m730:Scelte

element **Dichiarazione_Dich_Type/Frontespizio**

<p>diagram</p>	<pre> classDiagram class m730Frontespizio class m730SoggettoFiscale class m730DatiAnagrafici class m730StatoCivile class m730ResidenzaAnagrafica class m730DomicilioFiscaleSaldo class m730DomicilioFiscaleAcconto class m730CasiParticolariAddizionale class m730Firma class m730Rappresentante class m730SpazioServiziTelematici m730Frontespizio -- m730SoggettoFiscale m730Frontespizio -- m730DatiAnagrafici m730Frontespizio -.- m730StatoCivile m730Frontespizio -.- m730ResidenzaAnagrafica m730Frontespizio -.- m730DomicilioFiscaleSaldo m730Frontespizio -.- m730DomicilioFiscaleAcconto m730Frontespizio -.- m730CasiParticolariAddizionale m730Frontespizio -- m730Firma m730Frontespizio -.- m730Rappresentante m730Frontespizio -.- m730SpazioServiziTelematici </pre>
<p>type</p>	<p>extension of m730:Frontespizio Dich Type</p>
<p>children</p>	<p>m730:SoggettoFiscale m730:DatiAnagrafici m730:StatoCivile m730:ResidenzaAnagrafica m730:DomicilioFiscaleSaldo m730:DomicilioFiscaleAcconto m730:CasiParticolariAddizionale m730:Firma m730:Rappresentante m730:Spazio Servizi Telematici</p>

element Dichiarazione_Dich_Type/DatiContabili

<p>diagram</p>	
<p>type</p>	<p>m730:Dati_Contabili_Type</p>
<p>children</p>	<p>m730:Familiari m730:QuadroA m730:QuadroB m730:QuadroC m730:QuadroD m730:QuadroE m730:QuadroF m730:QuadroG m730:QuadroI m730:ProspettoLiquidazione m730:Prospetto_Annotazioni m730:QuadroK m730:QuadroL m730:QuadroW</p>

element Dichiarazione_Dich_Type/FuoriAssistenza

<p>diagram</p>	
<p>children</p>	<p>m730:FuoriAssistenzaQuadri m730:AnomaliaDatiSostituto m730:AnomaliaDatiRappresentante</p>

element **Dichiarazione_Dich_Type/FuoriAssistenza/FuoriAssistenzaQuadri**

diagram	
type	m730:Fuori_Assistenza_Type
children	m730:AnomaliaDatianagrafici m730:AnomaliaTerreni m730:AnomaliaFabbricati m730:AnomaliaLavDip m730:AnomaliaAltriRedditi m730:AnomaliaQuadroF

element **Dichiarazione_Dich_Type/FuoriAssistenza/AnomaliaDatiSostituto**

diagram	
type	DatoCB_Type

element **Dichiarazione_Dich_Type/FuoriAssistenza/AnomaliaDatiRappresentante**

diagram	
type	DatoCB_Type

element **Dichiarazione_Dich_Type/Scelte**

diagram	
type	sce:Scelte_Type
children	sce:Scelta5PerMille sce:Scelta8PerMille sce:Scelta2PerMille

complexType Documento_730-4

diagram	
children	m730:DatiAnagraficiDichiarante m730:Sostituto m730:SoggettoAssFiscale730-4 m730:AltriDati m730:DatiContabili730-4

element Documento_730-4/DatiAnagraficiDichiarante

diagram	
type	extension of Dati_Anagrafici_Type
children	Cognome Nome Sesso DataNascita ComuneNascita ProvinciaNascita m730:CFDichiarante

element Documento_730-4/DatiAnagraficiDichiarante/CFDichiarante

diagram	
type	DatoCF_Type

element **Documento_730-4/Sostituto**

<p>diagram</p>	
<p>type</p>	<p>m730:Sostituto_Type</p>
<p>children</p>	<p>m730:CodiceFiscale m730:DatiAnagraficiPF m730:DenominazionePNF m730:Residenza m730:Fax m730:CodiceSede</p>

element **Documento_730-4/SoggettoAssFiscale730-4**

<p>diagram</p>	
<p>children</p>	<p>m730:DatiCaf730-4 m730:DatiProfessionista730-4 m730:DatiAssociazione730-4 m730:DatiAgenzia730-4 m730:CasellaSostituto</p>

element **Documento_730-4/SoggettoAssFiscale730-4/DatiCaf730-4**

diagram	
type	extension of m730:Dati_CAF_Type
children	m730:CFCaf m730:DenominazioneCaf m730:NumeroAlbo m730:DomicilioCaf m730:UfficioPerifericoCaf

element **Documento_730-4/SoggettoAssFiscale730-4/DatiCaf730-4/DomicilioCaf**

diagram	
type	m730:Domicilio_Sogg_Ass_Fiscale_Type
children	m730:Comune m730:Provincia m730:CodiceComune m730:Cap m730:Indirizzo m730:Telefono m730:FAX m730:Email

element **Documento_730-4/SoggettoAssFiscale730-4/DatiCaf730-4/UfficioPerifericoCaf**

diagram	
children	m730:DomicilioUffPeriferico

element **Documento_730-4/SoggettoAssFiscale730-4/DatiCaf730-4/UfficioPerifericoCaf/DomicilioUffPeriferico**

diagram	<p>The diagram shows a class <code>m730:DomicilioUffPeriferico</code> extending the class <code>m730:Domicilio_Sogg_Ass_Fiscale_Type (extension)</code>. The extension includes the following attributes: <code>m730:Comune</code>, <code>m730:Provincia</code>, <code>m730:CodiceComune</code>, <code>m730:Cap</code>, <code>m730:Indirizzo</code>, <code>m730:Telefono</code>, <code>m730:FAX</code>, <code>m730:Email</code>, and <code>m730:Codice SedePeriferica</code>.</p>
type	extension of m730:Domicilio Sogg Ass Fiscale Type
children	m730:Comune m730:Provincia m730:CodiceComune m730:Cap m730:Indirizzo m730:Telefono m730:FAX m730:Email m730:CodiceSedePeriferica

element **Documento_730-4/SoggettoAssFiscale730-4/DatiCaf730-4/UfficioPerifericoCaf/DomicilioUffPeriferico/CodiceSedePeriferica**

diagram	<p>The diagram shows a class <code>m730:CodiceSedePeriferica</code>.</p>
type	DatoAN Type

element **Documento_730-4/SoggettoAssFiscale730-4/DatiProfessionista730-4**

diagram	<p>The diagram shows a class <code>m730:DatiProfessionista730-4</code> extending the class <code>m730:Dati_Professionista_Type (extension)</code>. The extension includes the following attributes: <code>m730:CFProfessionista</code>, <code>m730:CognomeProfessionista</code>, <code>m730:NomeProfessionista</code>, and <code>m730:DomicilioProf</code>.</p>
---------	---

type	extension of m730:Dati Professionista Type
children	m730:CFProfessionista m730:CognomeProfessionista m730:NomeProfessionista m730:DomicilioProf

element **Documento_730-4/SoggettoAssFiscale730-4/DatiProfessionista730-4/DomicilioProf**

diagram	<pre> classDiagram class m730DomicilioProf class m730DomicilioSoggAssFiscaleType["m730:Domicilio_Sogg_Ass_Fiscale_Type"] m730DomicilioProf m730DomicilioSoggAssFiscaleType m730DomicilioSoggAssFiscaleType .. m730Comune["m730:Comune"] m730DomicilioSoggAssFiscaleType .. m730Provincia["m730:Provincia"] m730DomicilioSoggAssFiscaleType .. m730CodiceComune["m730:CodiceComune"] m730DomicilioSoggAssFiscaleType .. m730Cap["m730:Cap"] m730DomicilioSoggAssFiscaleType .. m730Indirizzo["m730:Indirizzo"] m730DomicilioSoggAssFiscaleType .. m730Telefono["m730:Telefono"] m730DomicilioSoggAssFiscaleType .. m730FAX["m730:FAX"] m730DomicilioSoggAssFiscaleType .. m730Email["m730:Email"] </pre>
type	m730:Domicilio_Sogg_Ass_Fiscale_Type
children	m730:Comune m730:Provincia m730:CodiceComune m730:Cap m730:Indirizzo m730:Telefono m730:FAX m730:Email

element **Documento_730-4/SoggettoAssFiscale730-4/DatiAssociazione730-4**

diagram	<pre> classDiagram class m730DatiAssociazione7304 class m730DatiAssociazioniProfessionaleType["m730:Dati_Associazioni_Professionale_Type (extension)"] m730DatiAssociazione7304 m730DatiAssociazioniProfessionaleType m730DatiAssociazioniProfessionaleType .. m730CFAssociazione["m730:CFAssociazione"] m730DatiAssociazioniProfessionaleType .. m730DenominazioneAssociazione["m730:DenominazioneAssociazione..."] m730DatiAssociazioniProfessionaleType .. m730CFProfessionista["m730:CFProfessionista"] m730DatiAssociazioniProfessionaleType .. m730CognomeProfessionista["m730:CognomeProfessionista"] m730DatiAssociazioniProfessionaleType .. m730NomeProfessionista["m730:NomeProfessionista"] m730DatiAssociazione7304 .. m730DomicilioAssociazione["m730:DomicilioAssociazione"] </pre>
type	extension of m730:Dati Associazioni Professionale Type
children	m730:CFAssociazione m730:DenominazioneAssociazione m730:CFProfessionista m730:CognomeProfessionista m730:NomeProfessionista m730:DomicilioAssociazione

element **Documento_730-4/SoggettoAssFiscale730-4/DatiAssociazione730-4/DomicilioAssociazione**

diagram	
type	m730:Domicilio_Sogg_Ass_Fiscale_Type
children	m730:Comune m730:Provincia m730:CodiceComune m730:Cap m730:Indirizzo m730:Telefono m730:FAX m730:Email

element **Documento_730-4/SoggettoAssFiscale730-4/DatiAgenzia730-4**

diagram	
children	m730:CasellaAgenziaEntrate m730:Informazioni

element **Documento_730-4/SoggettoAssFiscale730-4/DatiAgenzia730-4/CasellaAgenziaEntrate**

diagram	
type	DatoCB_Type

element **Documento_730-4/SoggettoAssFiscale730-4/DatiAgenzia730-4/Informazioni**

diagram	
type	DatoAN_Type

element **Documento_730-4/SoggettoAssFiscale730-4/CasellaSostituto**

diagram	
type	DatoCB Type

element **Documento_730-4/AltriDati**

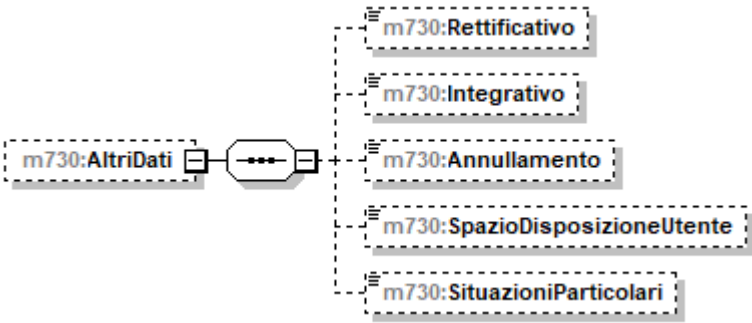
diagram	
children	m730:Rettificativo m730:Integrativo m730:Annullamento m730:SpazioDisposizioneUtente m730:SituazioniParticolari

element **Documento_730-4/AltriDati/Rettificativo**

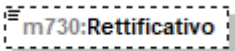
diagram									
type	m730:Rettificativo Type								
facets	<table border="1"> <thead> <tr> <th>Kind</th> <th>Value</th> </tr> </thead> <tbody> <tr> <td>enumeration</td> <td>1</td> </tr> <tr> <td>enumeration</td> <td>2</td> </tr> <tr> <td>enumeration</td> <td>3</td> </tr> </tbody> </table>	Kind	Value	enumeration	1	enumeration	2	enumeration	3
Kind	Value								
enumeration	1								
enumeration	2								
enumeration	3								

element **Documento_730-4/AltriDati/Integrativo**

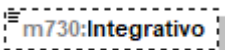
diagram									
type	m730:Integrativo Type								
facets	<table border="1"> <thead> <tr> <th>Kind</th> <th>Value</th> </tr> </thead> <tbody> <tr> <td>enumeration</td> <td>1</td> </tr> <tr> <td>enumeration</td> <td>2</td> </tr> <tr> <td>enumeration</td> <td>3</td> </tr> </tbody> </table>	Kind	Value	enumeration	1	enumeration	2	enumeration	3
Kind	Value								
enumeration	1								
enumeration	2								
enumeration	3								

element **Documento_730-4/AltriDati/Annullamento**

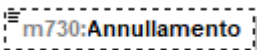
diagram	
type	DatoCB Type

element **Documento_730-4/AltriDati/SpazioDisposizioneUtente**

diagram	
type	DatoAN_Type

element **Documento_730-4/AltriDati/SituazioniParticolari**

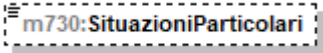
diagram	
type	DatoNP_Type

element **Documento_730-4/DatiContabili730-4**

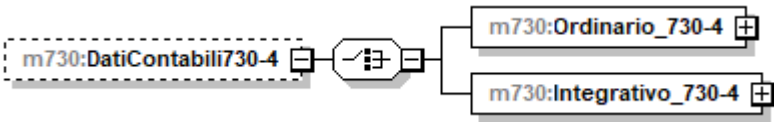
diagram	
children	m730:Ordinario_730-4 m730:Integrativo_730-4

element **Documento_730-4/DatiContabili730-4/Ordinario_730-4**

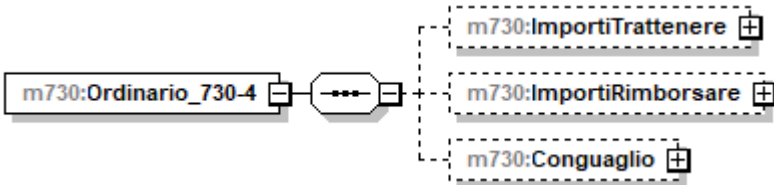
diagram	
children	m730:ImportiTrattenere m730:ImportiRimborsare m730:Conguaglio

element Documento_730-4/DatiContabili730-4/Ordinario_730-4/ImportiTrattenere

<p>diagram</p>	
<p>type</p>	<p>m730:Importi_Trattenere_730-4_Type</p>
<p>children</p>	<p>m730:lrpefTrattenere m730:AddRegTrattenere m730:AddComTrattenere m730:lrpefPrimaRataTrattenere m730:lrpefSecondaRataTrattenere m730:Tass SepAccontoTrattene... m730:AddComAccontoTrattene... m730:PremiRisultatoTrattenere m730:CedolareTrattenere m730:CedolarePrimaRataTrattenere m730:CedolareSecondaRataTrattenere</p>

element Documento_730-4/DatiContabili730-4/Ordinario_730-4/ImportiRimborsare

<p>diagram</p>	
<p>type</p>	<p>m730:Importi_Rimborsare_730-4_Type</p>
<p>children</p>	<p>m730:lrpefRimborsare m730:AddRegRimborsare m730:AddComRimborsare m730:CedolareRimborsare</p>

element **Documento_730-4/DatiContabili730-4/Ordinario_730-4/Conguaglio**

diagram	
children	m730:NumeroRate m730:ImportoRimborsare m730:ImportoTrattenere

element **Documento_730-4/DatiContabili730-4/Ordinario_730-4/Conguaglio/NumeroRate**

diagram	
type	DatoN1_Type

element **Documento_730-4/DatiContabili730-4/Ordinario_730-4/Conguaglio/ImportoRimborsare**

diagram	
type	DatoNP_Type

element **Documento_730-4/DatiContabili730-4/Ordinario_730-4/Conguaglio/ImportoTrattenere**

diagram	
type	DatoNP_Type

element **Documento_730-4/DatiContabili730-4/Integrativo_730-4**

diagram	
children	m730:ImportiRimborsare

element **Documento_730-4/DatiContabili730-4/Integrativo_730-4/ImportiRimborsare**

<p>diagram</p>	
<p>type</p>	<p>m730:Importi_Rimborsare_730-4_Integrativo_Type</p>
<p>children</p>	<p>m730:IrpefRimborsare m730:AddRegRimborsare m730:AddComRimborsare m730:CedolareRimborsare m730:TassazioneSepRimborsare m730:PremiRisultatoRimborsare</p>

complexType **Documento_730_Type**

<p>diagram</p>	
<p>type</p>	<p>extension of Documento_Type</p>
<p>children</p>	<p>m730:DichiarazioneDich m730:DichiarazioneCon m730:AltriDati m730:Sostituto m730:Mod730DipendentiSenzaSostituto m730:SoggettoAssFiscaleDoc m730:Documento_730-4 m730:EsitiContabili m730:DatiRettificati</p>

	m730:DatiRettificati				
attributes	Name identificativo	Type Identificativo_Type	Use required	Default	Fixed

element **Documento_730_Type/DichiarazioneDich**

diagram	
type	m730:Dichiarazione_Dich_Type
children	m730:Frontespizio m730:DatiContabili m730:FuoriAssistenza m730:Scelte

element **Documento_730_Type/DichiarazioneCon**

diagram	
type	m730:Dichiarazione_Con_Type
children	m730:Frontespizio m730:DatiContabili m730:FuoriAssistenzaQuadri m730:Scelte

element **Documento_730_Type/AltriDati**

diagram	
children	m730:FlagConferma m730:FlagAssenzaDati730-4 m730:FlagCfErratoDicTrasmessa m730:Rettificativo m730:Integrativo m730:CfProduttoreSoftware m730:SpazioDisposizioneUtente m730:DichiarazioneCongiunta m730:SituazioniParticolari m730:Mod730SenzaSostituto m730:ComunicazioneDatiRettificati m730:SostCafProfessNonDelegato

element **Documento_730_Type/AltriDati/FlagConferma**

diagram	
type	DatoCB_Type

element **Documento_730_Type/AltriDati/FlagAssenzaDati730-4**

diagram	
type	DatoCB_Type

element **Documento_730_Type/AltriDati/FlagCfErratoDicTrasmessa**

diagram	
type	DatoCF_Type

element **Documento_730_Type/AltriDati/Rettificativo**

diagram									
type	m730:Rettificativo_Type								
facets	<table border="1"> <thead> <tr> <th>Kind</th> <th>Value</th> </tr> </thead> <tbody> <tr> <td>enumeration</td> <td>1</td> </tr> <tr> <td>enumeration</td> <td>2</td> </tr> <tr> <td>enumeration</td> <td>3</td> </tr> </tbody> </table>	Kind	Value	enumeration	1	enumeration	2	enumeration	3
Kind	Value								
enumeration	1								
enumeration	2								
enumeration	3								

element **Documento_730_Type/AltriDati/Integrativo**

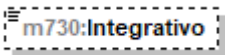
diagram									
type	m730:Integrativo_Type								
facets	<table border="1"> <thead> <tr> <th>Kind</th> <th>Value</th> </tr> </thead> <tbody> <tr> <td>enumeration</td> <td>1</td> </tr> <tr> <td>enumeration</td> <td>2</td> </tr> <tr> <td>enumeration</td> <td>3</td> </tr> </tbody> </table>	Kind	Value	enumeration	1	enumeration	2	enumeration	3
Kind	Value								
enumeration	1								
enumeration	2								
enumeration	3								

element **Documento_730_Type/AltriDati/CfProduttoreSoftware**

diagram	
type	DatoCF_Type

element **Documento_730_Type/AltriDati/SpazioDisposizioneUtente**

diagram	
type	DatoAN_Type

element **Documento_730_Type/AltriDati/DichiarazioneCongiunta**

diagram	
type	DatoCB_Type

element **Documento_730_Type/AltriDati/SituazioniParticolari**

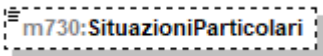
diagram	
type	DatoNP_Type

element **Documento_730_Type/AltriDati/Mod730SenzaSostituto**

diagram	
type	restriction of DatoAN_Type
facets	Kind enumeration Value A

element **Documento_730_Type/AltriDati/ComunicazioneDatiRettificati**

diagram	
type	DatoCB_Type

element **Documento_730_Type/AltriDati/SostCafProfessNonDelegato**

diagram	
type	DatoCB_Type

element **Documento_730_Type/Sostituto**

diagram	
type	m730:Sostituto_Type
children	m730:CodiceFiscale m730:DatiAnagraficiPF m730:DenominazionePNF m730:Residenza m730:Fax m730:CodiceSede

element **Documento_730_Type/Mod730DipendentiSenzaSostituto**

diagram	
type	DatoCB_Type

element **Documento_730_Type/SoggettoAssFiscaleDoc**

<p>diagram</p>	
<p>type</p>	<p>m730:Soggetto_Assistenza_Fiscale_Doc_Type</p>
<p>children</p>	<p>m730:DataConsegna m730:TipologiaSoggettoAssFisc m730:SostitutoCF m730:DatiCafDoc m730:DatiProfessionistaDoc m730:DatiAssociazioneDoc m730:AgenziaEntrate</p>

element **Documento_730_Type/Documento_730-4**

<p>diagram</p>	
<p>type</p>	<p>m730:Documento_730-4</p>
<p>children</p>	<p>m730:DatiAnagraficiDichiarante m730:Sostituto m730:SoggettoAssFiscale730-4 m730:AltriDati m730:DatiContabili730-4</p>

element **Documento_730_Type/EsitiContabili**

diagram	
children	m730:Conguaglio m730:Mod730Integrativo m730:VersamentiF24 m730:ConguaglioSostitutive

element **Documento_730_Type/EsitiContabili/Conguaglio**

diagram	
type	m730:Conguaglio_Type
children	m730:NumeroRate m730:ImportoTrattenutoSaldo m730:ImportoTrattenutoAcconto m730:ImportoDaVersareF24Saldo m730:ImportoDaVersareF24Acc... m730:ImportoRimborsato m730:ImportoRimborsatoAgenzia m730:OpzioneInformativa

element **Documento_730_Type/EsitiContabili/Mod730Integrativo**

diagram	
type	m730:Mod730_Integrativo_Type

children	m730:ImportiRimborsare m730:ImportoRimborsato m730:ImportoRimborsatoAgenzia
----------	---

element **Documento_730_Type/EsitiContabili/VersamentiF24**

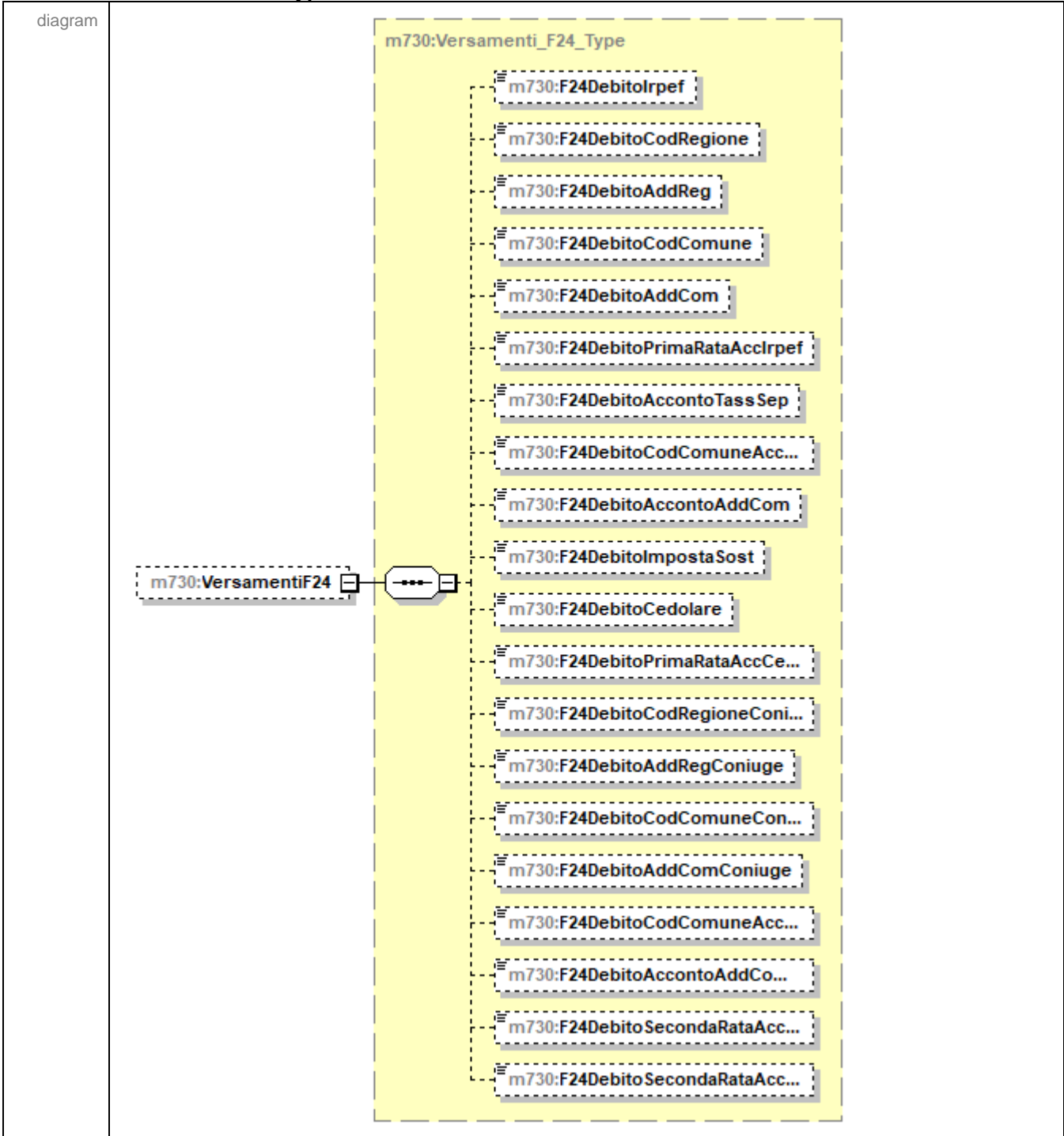

type	m730:Versamenti_F24_Type
------	--

children	m730:F24DebitoIrpef m730:F24DebitoCodRegione m730:F24DebitoAddReg m730:F24DebitoCodComune m730:F24DebitoAddCom m730:F24DebitoPrimaRataAcclrpef m730:F24DebitoAccontoTassSep m730:F24DebitoCodComuneAcconto m730:F24DebitoAccontoAddCom m730:F24DebitoImpostaSost
----------	--

	m730:F24DebitoCedolare m730:F24DebitoPrimaRataAccCedolare m730:F24DebitoCodRegioneConiuge m730:F24DebitoAddRegConiuge m730:F24DebitoCodComuneConiuge m730:F24DebitoAddComConiuge m730:F24DebitoCodComuneAccontoConiuge m730:F24DebitoAccontoAddComConiuge m730:F24DebitoSecondaRataAcclrpef m730:F24DebitoSecondaRataAccCedolare
--	--

element **Documento_730_Type/EsitiContabili/ConguaglioSostitutive**

diagram	
type	m730:Conguaglio_Sostitutive_Type
children	m730:ImportoSaldoDic m730:ImportoSaldoCon m730:ImportoAccontoDic m730:ImportoAccontoCon m730:ImportoCreditoDic m730:ImportoCreditoCon

element **Documento_730_Type/DatiRettificati**

diagram	
type	m730:Dati_Rettificati_Type
children	m730:Modulo

complexType **Domanda_Accatastamento_Type**

diagram	
children	m730:Data m730:Numero m730:ProvinciaUfficio

element **Domanda_Accatamento_Type/Data**

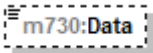
diagram	
type	DatoDT_Type

element **Domanda_Accatamento_Type/Numero**

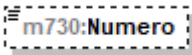
diagram	
type	DatoAN_Type

element **Domanda_Accatamento_Type/ProvinciaUfficio**

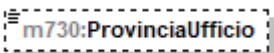
diagram	
type	PN_Type

complexType **Domicilio_Fiscale_Type**

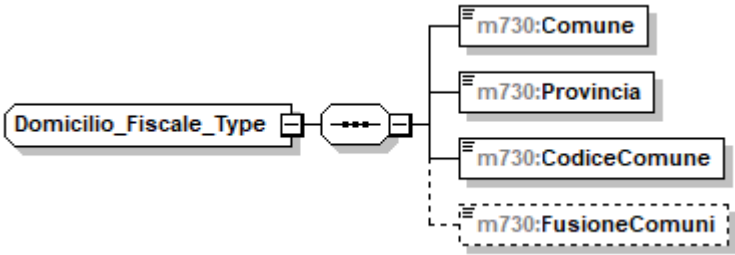
diagram	
children	m730:Comune m730:Provincia m730:CodiceComune m730:FusioneComuni

element **Domicilio_Fiscale_Type/Comune**

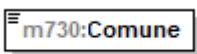
diagram	
type	DatoAN_Type

element **Domicilio_Fiscale_Type/Provincia**

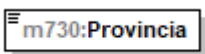
diagram	
type	PR_Type

element **Domicilio_Fiscale_Type/CodiceComune**

diagram	
type	DatoAN_Type

element **Domicilio_Fiscale_Type/FusioneComuni**

diagram	
type	DatoAN_Type

complexType **Domicilio_Sogg_Ass_Fiscale_Type**

diagram	
children	m730:Comune m730:Provincia m730:CodiceComune m730:Cap m730:Indirizzo m730:Telefono m730:FAX m730:Email

element **Domicilio_Sogg_Ass_Fiscale_Type/Comune**

diagram	
type	DatoAN_Type

element **Domicilio_Sogg_Ass_Fiscale_Type/Provincia**

diagram	
type	PR_Type

element **Domicilio_Sogg_Ass_Fiscale_Type/CodiceComune**

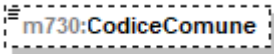
diagram	
type	DatoAN_Type

element **Domicilio_Sogg_Ass_Fiscale_Type/Cap**

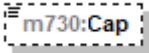
diagram	
type	DatoAN_Type

element **Domicilio_Sogg_Ass_Fiscale_Type/Indirizzo**

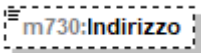
diagram	
type	DatoAN_Type

element **Domicilio_Sogg_Ass_Fiscale_Type/Telefono**

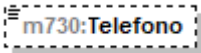
diagram	
type	DatoAN_Type

element **Domicilio_Sogg_Ass_Fiscale_Type/FAX**

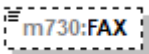
diagram	
type	DatoAN_Type

element **Domicilio_Sogg_Ass_Fiscale_Type/Email**

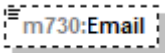
diagram	
type	DatoEM_Type

complexType **Eccedenze_Estero_Type**

diagram	
type	extension of m730:Acconti_Eccedenze_Type
children	m730:EccedenzaPrecDic m730:EccedenzaCompensata m730:AccontiVersati m730:EccedenzaVersamento

complexType **Eccedenze_Oltre_Anno_Type**

diagram	
children	m730:Anno m730:lrpef m730:SostitutivaQuadroRT m730:CedolareSecca m730:CodiceRegione m730:AddRegionalelrpef m730:CodiceCatastaleComune m730:AddComunalelrpef m730:ImpostaSostitutiva

element **Eccedenze_Oltre_Anno_Type/Anno**

diagram	
type	DatoDA_Type

element **Eccedenze_Oltre_Anno_Type/Irpef**

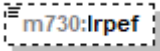
diagram	
type	DatoNP_Type

element **Eccedenze_Oltre_Anno_Type/SostitutivaQuadroRT**

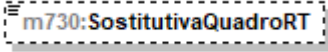
diagram	
type	DatoNP_Type

element **Eccedenze_Oltre_Anno_Type/CedolareSecca**

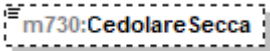
diagram	
type	DatoNP_Type

element **Eccedenze_Oltre_Anno_Type/CodiceRegione**

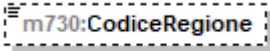
diagram																																													
type	Codice_Regione_Type																																												
facets	<table border="1"> <thead> <tr> <th>Kind</th> <th>Value</th> </tr> </thead> <tbody> <tr><td>enumeration</td><td>1</td></tr> <tr><td>enumeration</td><td>2</td></tr> <tr><td>enumeration</td><td>3</td></tr> <tr><td>enumeration</td><td>4</td></tr> <tr><td>enumeration</td><td>5</td></tr> <tr><td>enumeration</td><td>6</td></tr> <tr><td>enumeration</td><td>7</td></tr> <tr><td>enumeration</td><td>8</td></tr> <tr><td>enumeration</td><td>9</td></tr> <tr><td>enumeration</td><td>10</td></tr> <tr><td>enumeration</td><td>11</td></tr> <tr><td>enumeration</td><td>12</td></tr> <tr><td>enumeration</td><td>13</td></tr> <tr><td>enumeration</td><td>14</td></tr> <tr><td>enumeration</td><td>15</td></tr> <tr><td>enumeration</td><td>16</td></tr> <tr><td>enumeration</td><td>17</td></tr> <tr><td>enumeration</td><td>18</td></tr> <tr><td>enumeration</td><td>19</td></tr> <tr><td>enumeration</td><td>20</td></tr> <tr><td>enumeration</td><td>21</td></tr> </tbody> </table>	Kind	Value	enumeration	1	enumeration	2	enumeration	3	enumeration	4	enumeration	5	enumeration	6	enumeration	7	enumeration	8	enumeration	9	enumeration	10	enumeration	11	enumeration	12	enumeration	13	enumeration	14	enumeration	15	enumeration	16	enumeration	17	enumeration	18	enumeration	19	enumeration	20	enumeration	21
Kind	Value																																												
enumeration	1																																												
enumeration	2																																												
enumeration	3																																												
enumeration	4																																												
enumeration	5																																												
enumeration	6																																												
enumeration	7																																												
enumeration	8																																												
enumeration	9																																												
enumeration	10																																												
enumeration	11																																												
enumeration	12																																												
enumeration	13																																												
enumeration	14																																												
enumeration	15																																												
enumeration	16																																												
enumeration	17																																												
enumeration	18																																												
enumeration	19																																												
enumeration	20																																												
enumeration	21																																												

element **Eccedenze_Oltre_Anno_Type/AddRegionaleIrpef**

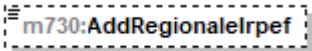
diagram	
type	DatoNP_Type

element **Eccedenze_Oltre_Anno_Type/CodiceCatastaleComune**

diagram	
type	restriction of DatoAN_Type

element **Eccedenze_Oltre_Anno_Type/AddComunalelrpef**

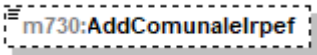
diagram	
type	DatoNP_Type

element **Eccedenze_Oltre_Anno_Type/ImpostaSostitutiva**

diagram	
type	DatoNP_Type

complexType **Eccedenze_Type**

<p>diagram</p>	
<p>children</p>	<p>m730:Irpef m730:IrpefCompF24 m730:SostitutivaQuadroRT m730:SostitutivaQuadroRTcompF24 m730:CedolareSecca m730:CedolareSeccaCompF24 m730:CodiceRegione m730:AddRegionaleIrpef m730:AddRegionaleIrpefCompF24 m730:CodiceCatastaleComune m730:AddComunaleIrpef m730:AddComunaleIrpefF24 m730:PremioRisultato m730:PremioRisultatoCompF24</p>

element **Eccedenze_Type/Irpef**

<p>diagram</p>	
<p>type</p>	<p>DatoNP_Type</p>

element **Eccedenze_Type/IrpefCompF24**

<p>diagram</p>	
<p>type</p>	<p>DatoNP_Type</p>

element **Eccedenze_Type/SostitutivaQuadroRT**

diagram	
type	DatoNP_Type

element **Eccedenze_Type/SostitutivaQuadroRTcompF24**

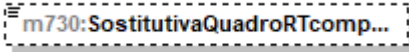
diagram	
type	DatoNP_Type

element **Eccedenze_Type/CedolareSecca**

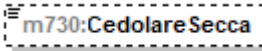
diagram	
type	DatoNP_Type

element **Eccedenze_Type/CedolareSeccaCompF24**

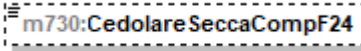
diagram	
type	DatoNP_Type

element **Eccedenze_Type/CodiceRegione**

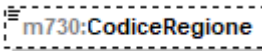
diagram																																													
type	Codice Regione_Type																																												
facets	<table border="1"> <thead> <tr> <th>Kind</th> <th>Value</th> </tr> </thead> <tbody> <tr><td>enumeration</td><td>1</td></tr> <tr><td>enumeration</td><td>2</td></tr> <tr><td>enumeration</td><td>3</td></tr> <tr><td>enumeration</td><td>4</td></tr> <tr><td>enumeration</td><td>5</td></tr> <tr><td>enumeration</td><td>6</td></tr> <tr><td>enumeration</td><td>7</td></tr> <tr><td>enumeration</td><td>8</td></tr> <tr><td>enumeration</td><td>9</td></tr> <tr><td>enumeration</td><td>10</td></tr> <tr><td>enumeration</td><td>11</td></tr> <tr><td>enumeration</td><td>12</td></tr> <tr><td>enumeration</td><td>13</td></tr> <tr><td>enumeration</td><td>14</td></tr> <tr><td>enumeration</td><td>15</td></tr> <tr><td>enumeration</td><td>16</td></tr> <tr><td>enumeration</td><td>17</td></tr> <tr><td>enumeration</td><td>18</td></tr> <tr><td>enumeration</td><td>19</td></tr> <tr><td>enumeration</td><td>20</td></tr> <tr><td>enumeration</td><td>21</td></tr> </tbody> </table>	Kind	Value	enumeration	1	enumeration	2	enumeration	3	enumeration	4	enumeration	5	enumeration	6	enumeration	7	enumeration	8	enumeration	9	enumeration	10	enumeration	11	enumeration	12	enumeration	13	enumeration	14	enumeration	15	enumeration	16	enumeration	17	enumeration	18	enumeration	19	enumeration	20	enumeration	21
Kind	Value																																												
enumeration	1																																												
enumeration	2																																												
enumeration	3																																												
enumeration	4																																												
enumeration	5																																												
enumeration	6																																												
enumeration	7																																												
enumeration	8																																												
enumeration	9																																												
enumeration	10																																												
enumeration	11																																												
enumeration	12																																												
enumeration	13																																												
enumeration	14																																												
enumeration	15																																												
enumeration	16																																												
enumeration	17																																												
enumeration	18																																												
enumeration	19																																												
enumeration	20																																												
enumeration	21																																												

element **Eccedenze_Type/AddRegionalelrpef**

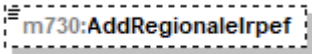
diagram	
type	DatoNP_Type

element **Eccedenze_Type/AddRegionalelrpefCompF24**

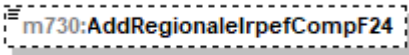
diagram	
type	DatoNP_Type

element **Eccedenze_Type/CodiceCatastaleComune**

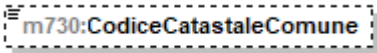
diagram	
type	restriction of DatoAN_Type

element **Eccedenze_Type/AddComunalelrpef**

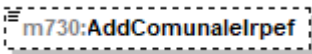
diagram	
type	DatoNP_Type

element **Eccedenze_Type/AddComunalelrpefF24**

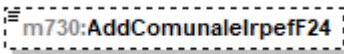
diagram	
type	DatoNP_Type

element **Eccedenze_Type/PremioRisultato**

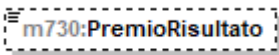
diagram	
type	DatoNP_Type

element **Eccedenze_Type/PremioRisultatoCompF24**

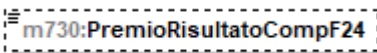
diagram	
type	DatoNP_Type

complexType **Elemento_Integrativo_Type**

diagram	
children	m730:Irpef m730:AddizionaleRegionaleIrpef m730:AddComunaleIrpef m730:CedolareSecca

element **Elemento_Integrativo_Type/Irpef**

diagram	
type	DatoNP_Type

element **Elemento_Integrativo_Type/AddizionaleRegionaleIrpef**

diagram	
type	DatoNP_Type

element **Elemento_Integrativo_Type/AddComunaleIrpef**

diagram	
type	DatoNP_Type

element **Elemento_Integrativo_Type/CedolareSecca**

diagram	
type	DatoNP_Type

complexType **Erogazioni_Onlus_Type**

diagram	
children	m730:Importo m730:ResiduoPrecedenteDic m730:ResiduoDueAnniPrecDic m730:ResiduoTreAnniPrecDic m730:ResiduoQuattroAnniPrecDic

element **Erogazioni_Onlus_Type/Importo**

diagram	
type	DatoNP_Type

element **Erogazioni_Onlus_Type/ResiduoPrecedenteDic**

diagram	
type	DatoNP_Type

element **Erogazioni_Onlus_Type/ResiduoDueAnniPrecDic**

diagram	
type	DatoNP_Type

element **Erogazioni_Onlus_Type/ResiduoTreAnniPrecDic**

diagram	
type	DatoNP_Type

element **Erogazioni_Onlus_Type/ResiduoQuattroAnniPrecDic**

diagram	
type	DatoNP_Type

complexType **Esenzione_Add_Comunale_Type**

diagram	
children	m730:SogliaEsenzioneSaldo m730:SogliaEsenzioneAcconto

element **Esenzione_Add_Comunale_Type/SogliaEsenzioneSaldo**

diagram	
type	m730:Soglie_Esenzione_Type
children	m730:SogliaEsenzione m730:EsenzioneTotale

element **Esenzione_Add_Comunale_Type/SogliaEsenzioneAcconto**

diagram	
type	m730:Soglie_Esenzione_Type
children	m730:SogliaEsenzione m730:EsenzioneTotale

complexType **Esito_Liquidazione_Type**

diagram	
children	m730:Credito m730:Debito

element **Esito_Liquidazione_Type/Credito**

diagram	<p>The diagram shows a box labeled 'm730:Credito' connected to a larger container box labeled 'm730:Credito_Type'. Inside the container, there are four sub-elements: 'm730:NonRimborsabile', 'm730:Credito', 'm730:CreditoF24', and 'm730:CreditoRimborso'.</p>
type	m730:Credito_Type
children	m730:NonRimborsabile m730:Credito m730:CreditoF24 m730:CreditoRimborso

element **Esito_Liquidazione_Type/Debito**

diagram	<p>The diagram shows a box labeled 'm730:Debito' connected to a larger container box labeled 'm730:Debito_Type'. Inside the container, there are two sub-elements: 'm730:NonVersare' and 'm730:ImportoDaTrattenere'.</p>
type	m730:Debito_Type
children	m730:NonVersare m730:ImportoDaTrattenere

complexType **Esito_Sost_Type**

diagram	<p>The diagram shows a box labeled 'Esito_Sost_Type' connected to a larger container box. Inside the container, there are eight sub-elements: 'm730:ImpostaDovuta', 'm730:EccedenzaPrecDic', 'm730:AccontiVersati', 'm730:ImpostaDebito', 'm730:ImpostaCredito', 'm730:EccedenzaVers', 'm730:CreditoComp', and 'm730:Rimborso'.</p>
children	m730:ImpostaDovuta m730:EccedenzaPrecDic m730:AccontiVersati m730:ImpostaDebito m730:ImpostaCredito m730:EccedenzaVers m730:CreditoComp m730:Rimborso

element **Esito_Sost_Type/ImpostaDovuta**

diagram	
type	DatoNP_Type

element **Esito_Sost_Type/EccedenzaPrecDic**

diagram	
type	DatoNP_Type

element **Esito_Sost_Type/AcontiVersati**

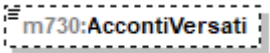
diagram	
type	DatoNP_Type

element **Esito_Sost_Type/ImpostaDebito**

diagram	
type	DatoNP_Type

element **Esito_Sost_Type/ImpostaCredito**

diagram	
type	DatoNP_Type

element **Esito_Sost_Type/EccedenzaVers**

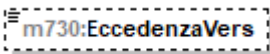
diagram	
type	DatoNP_Type

element **Esito_Sost_Type/CreditoComp**

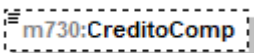
diagram	
type	DatoNP_Type

element **Esito_Sost_Type/Rimborso**

diagram	
type	DatoNP_Type

complexType **Fabbricato_Agev_Type**

diagram	
children	m730:NumeroRigoRiferimento m730:NumModuloRiferimento m730:DatiContratto m730:CasellaInf30Giorni m730:AnnoDichiarazioneIcilmu

element **Fabbricato_Agev_Type/NumeroRigoRiferimento**

diagram																							
type	m730:Fabbricato_Agev_Numero_Rigo_Type																						
facets	<table border="1"> <thead> <tr> <th>Kind</th> <th>Value</th> </tr> </thead> <tbody> <tr><td>enumeration</td><td>1</td></tr> <tr><td>enumeration</td><td>2</td></tr> <tr><td>enumeration</td><td>3</td></tr> <tr><td>enumeration</td><td>4</td></tr> <tr><td>enumeration</td><td>5</td></tr> <tr><td>enumeration</td><td>6</td></tr> <tr><td>enumeration</td><td>7</td></tr> <tr><td>enumeration</td><td>8</td></tr> <tr><td>enumeration</td><td>9</td></tr> <tr><td>enumeration</td><td>10</td></tr> </tbody> </table>	Kind	Value	enumeration	1	enumeration	2	enumeration	3	enumeration	4	enumeration	5	enumeration	6	enumeration	7	enumeration	8	enumeration	9	enumeration	10
Kind	Value																						
enumeration	1																						
enumeration	2																						
enumeration	3																						
enumeration	4																						
enumeration	5																						
enumeration	6																						
enumeration	7																						
enumeration	8																						
enumeration	9																						
enumeration	10																						

element **Fabbricato_Agev_Type/NumModuloRiferimento**

diagram	
type	DatoNP_Type

element **Fabbricato_Agev_Type/DatiContratto**

diagram	<pre> classDiagram class m730DatiContratto class m730Dati_Contratto_Type { m730DataRegContratto m730SerieContratto m730NumeroContratto m730Sottonumero m730CodiceUfficio m730IdentificativoContratto } m730DatiContratto -- m730Dati_Contratto_Type </pre>
type	m730:Dati_Contratto_Type
children	m730:DataRegContratto m730:SerieContratto m730:NumeroContratto m730:Sottonumero m730:CodiceUfficio m730:IdentificativoContratto

element **Fabbricato_Agev_Type/CasellaInf30Giorni**

diagram	<pre> classDiagram class m730CasellaInf30Giorni </pre>
type	DatoCB_Type

element **Fabbricato_Agev_Type/AnnoDichiarazioneIcilmu**

diagram	<pre> classDiagram class m730AnnoDichiarazioneIcilmu </pre>
type	DatoDA_Type

complexType **Fabbricato_Ord_Type**

diagram	
children	m730:Rendita m730:Utilizzo m730:GiorniPossesso m730:PercPossesso m730:CodiceCanone m730:CanoneLocazione m730:CasiParticolari m730:CasellaContinuazione m730:CodiceComune m730:OpzioneCedolare m730:CasellaCasiPartimu m730:AltriDati

element **Fabbricato_Ord_Type/Rendita**

diagram	
type	DatoNP_Type

element **Fabbricato_Ord_Type/Utilizzo**

diagram																							
type	restriction of m730:Utilizzo_Fabbricato_Type																						
facets	<table border="1"> <thead> <tr> <th>Kind</th> <th>Value</th> </tr> </thead> <tbody> <tr><td>enumeration</td><td>1</td></tr> <tr><td>enumeration</td><td>2</td></tr> <tr><td>enumeration</td><td>3</td></tr> <tr><td>enumeration</td><td>4</td></tr> <tr><td>enumeration</td><td>5</td></tr> <tr><td>enumeration</td><td>8</td></tr> <tr><td>enumeration</td><td>9</td></tr> <tr><td>enumeration</td><td>10</td></tr> <tr><td>enumeration</td><td>11</td></tr> <tr><td>enumeration</td><td>12</td></tr> </tbody> </table>	Kind	Value	enumeration	1	enumeration	2	enumeration	3	enumeration	4	enumeration	5	enumeration	8	enumeration	9	enumeration	10	enumeration	11	enumeration	12
Kind	Value																						
enumeration	1																						
enumeration	2																						
enumeration	3																						
enumeration	4																						
enumeration	5																						
enumeration	8																						
enumeration	9																						
enumeration	10																						
enumeration	11																						
enumeration	12																						

	enumeration 14
	enumeration 15
	enumeration 16
	enumeration 17

element **Fabbricato_Ord_Type/GiorniPossesso**

diagram	
type	restriction of DatoNP_Type

element **Fabbricato_Ord_Type/PercPossesso**

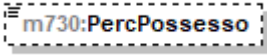
diagram	
type	DatoPC_Type

element **Fabbricato_Ord_Type/CodiceCanone**

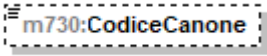
diagram											
type	m730:Codice_Canone_Type										
facets	<table border="1"> <thead> <tr> <th>Kind</th> <th>Value</th> </tr> </thead> <tbody> <tr> <td>enumeration</td> <td>1</td> </tr> <tr> <td>enumeration</td> <td>2</td> </tr> <tr> <td>enumeration</td> <td>3</td> </tr> <tr> <td>enumeration</td> <td>4</td> </tr> </tbody> </table>	Kind	Value	enumeration	1	enumeration	2	enumeration	3	enumeration	4
Kind	Value										
enumeration	1										
enumeration	2										
enumeration	3										
enumeration	4										

element **Fabbricato_Ord_Type/CanoneLocazione**

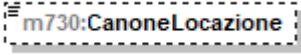
diagram	
type	DatoNP_Type

element **Fabbricato_Ord_Type/CasiParticolari**

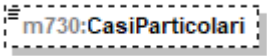
diagram																	
type	m730:Casi_Particolari_Fabbricato_Type																
facets	<table border="1"> <thead> <tr> <th>Kind</th> <th>Value</th> </tr> </thead> <tbody> <tr> <td>enumeration</td> <td>1</td> </tr> <tr> <td>enumeration</td> <td>3</td> </tr> <tr> <td>enumeration</td> <td>4</td> </tr> <tr> <td>enumeration</td> <td>5</td> </tr> <tr> <td>enumeration</td> <td>6</td> </tr> <tr> <td>enumeration</td> <td>7</td> </tr> <tr> <td>enumeration</td> <td>8</td> </tr> </tbody> </table>	Kind	Value	enumeration	1	enumeration	3	enumeration	4	enumeration	5	enumeration	6	enumeration	7	enumeration	8
Kind	Value																
enumeration	1																
enumeration	3																
enumeration	4																
enumeration	5																
enumeration	6																
enumeration	7																
enumeration	8																

element **Fabbricato_Ord_Type/CasellaContinuazione**

diagram	
type	DatoCB_Type

element **Fabbricato_Ord_Type/CodiceComune**

diagram	
type	restriction of DatoAN_Type

element **Fabbricato_Ord_Type/OpzioneCedolare**

diagram	
type	DatoCB_Type

element **Fabbricato_Ord_Type/CasellaCasiPartImu**

diagram									
type	restriction of DatoN1_Type								
facets	<table border="1"> <thead> <tr> <th>Kind</th> <th>Value</th> </tr> </thead> <tbody> <tr> <td>enumeration</td> <td>1</td> </tr> <tr> <td>enumeration</td> <td>2</td> </tr> <tr> <td>enumeration</td> <td>3</td> </tr> </tbody> </table>	Kind	Value	enumeration	1	enumeration	2	enumeration	3
Kind	Value								
enumeration	1								
enumeration	2								
enumeration	3								

element **Fabbricato_Ord_Type/AltriDati**

diagram							
type	restriction of DatoN1_Type						
facets	<table border="1"> <thead> <tr> <th>Kind</th> <th>Value</th> </tr> </thead> <tbody> <tr> <td>enumeration</td> <td>1</td> </tr> <tr> <td>enumeration</td> <td>2</td> </tr> </tbody> </table>	Kind	Value	enumeration	1	enumeration	2
Kind	Value						
enumeration	1						
enumeration	2						

complexType **Familiari_Type**

diagram	
children	m730:PrimoModulo m730:Modulo

element **Familiari_Type/PrimoModulo**

diagram	
type	m730:Primo_Modulo_Familiari_Type
children	m730:Coniuge m730:PrimoFiglio m730:Familiari m730:FigliAffidoPread

element **Familiari_Type/Modulo**

diagram	
type	m730:Modulo_Familiari_Type
children	m730:Coniuge m730:PrimoFiglio m730:Familiari

complexType **Firma_Dichiarazione_Type**

diagram	
children	m730:NumeroModelli m730:FirmaDichiarazione m730:OpzioneInformativa m730:SoggettoFiscalmenteCarico

element **Firma_Dichiarazione_Type/NumeroModelli**

diagram	
type	DatoNP_Type

element **Firma_Dichiarazione_Type/FirmaDichiarazione**

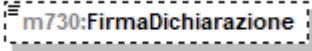
diagram	
type	DatoCB_Type

element **Firma_Dichiarazione_Type/OpzioneInformativa**

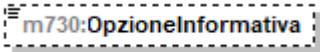
diagram	
type	DatoCB_Type

element **Firma_Dichiarazione_Type/SoggettoFiscalmenteCarico**

diagram							
type	restriction of DatoNP_Type						
facets	<table border="1"> <thead> <tr> <th>Kind</th> <th>Value</th> </tr> </thead> <tbody> <tr> <td>enumeration</td> <td>1</td> </tr> <tr> <td>enumeration</td> <td>2</td> </tr> </tbody> </table>	Kind	Value	enumeration	1	enumeration	2
Kind	Value						
enumeration	1						
enumeration	2						

complexType **Fondo_Pensione_Dipendenti_Pubblici_Type**

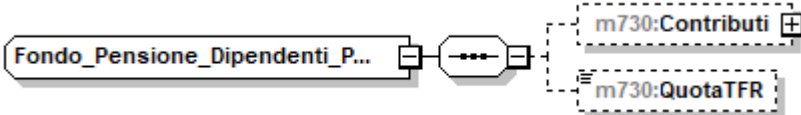
diagram	
children	m730:Contributi m730:QuotaTFR

element **Fondo_Pensione_Dipendenti_Pubblici_Type/Contributi**

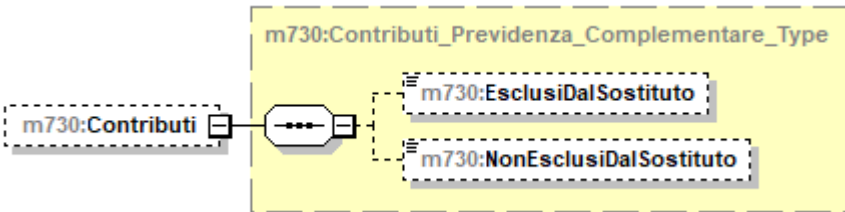
diagram	
type	m730:Contributi_Previdenza_Complementare_Type

children	m730:EsclusiDalSostituto m730:NonEsclusiDalSostituto
----------	--

element **Fondo_Pensione_Dipendenti_Pubblici_Type/QuotaTFR**

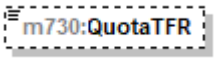
diagram	
type	DatoNP_Type

complexType **Frontespizio_730_Type**

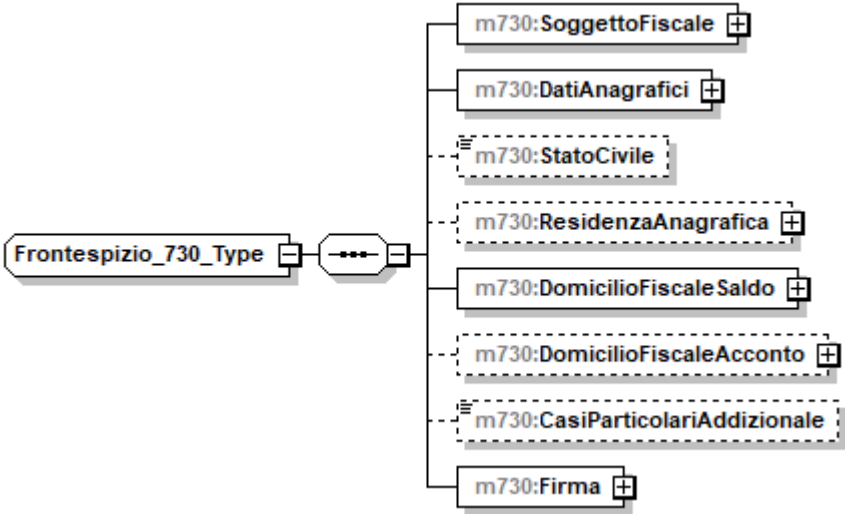
diagram	
children	m730:SoggettoFiscale m730:DatiAnagrafici m730:StatoCivile m730:ResidenzaAnagrafica m730:DomicilioFiscaleSaldo m730:DomicilioFiscaleAcconto m730:CasiParticolariAddizionale m730:Firma

element **Frontespizio_730_Type/SoggettoFiscale**

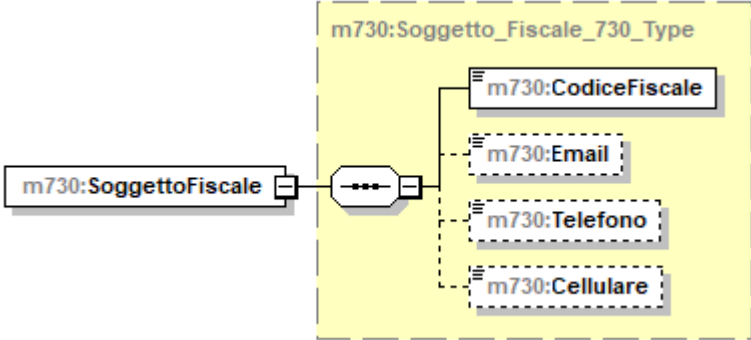
diagram	
type	m730:Soggetto_Fiscale_730_Type
children	m730:CodiceFiscale m730:Email m730:Telefono m730:Cellulare

element **Frontespizio_730_Type/DatiAnagrafici**

diagram	<p>The diagram shows a class <code>m730:DatiAnagrafici</code> connected to a class <code>sc:Dati_Anagrafici_Type</code>. The <code>sc:Dati_Anagrafici_Type</code> class contains several elements: <code>Cognome</code>, <code>Nome</code>, <code>Sesso</code>, <code>DataNascita</code>, <code>ComuneNascita</code>, and <code>ProvinciaNascita</code>. The <code>ProvinciaNascita</code> element is shown with a dashed border, indicating it is optional.</p>
type	Dati_Anagrafici_Type
children	Cognome Nome Sesso DataNascita ComuneNascita ProvinciaNascita

element **Frontespizio_730_Type/StatoCivile**

diagram	<p>The diagram shows a class <code>m730:StatoCivile</code> with a dashed border, indicating it is optional.</p>								
type	m730:Stato_Civile_Type								
facets	<table border="1"> <thead> <tr> <th>Kind</th> <th>Value</th> </tr> </thead> <tbody> <tr> <td>enumeration</td> <td>6</td> </tr> <tr> <td>enumeration</td> <td>7</td> </tr> <tr> <td>enumeration</td> <td>8</td> </tr> </tbody> </table>	Kind	Value	enumeration	6	enumeration	7	enumeration	8
Kind	Value								
enumeration	6								
enumeration	7								
enumeration	8								

element **Frontespizio_730_Type/ResidenzaAnagrafica**

<p>diagram</p>	
<p>type</p>	<p>m730:Residenza_Anagrafica_730_Type</p>
<p>children</p>	<p>Comune Provincia CodiceComune Indirizzo Cap DataVariazione m730:Tipologia m730:NumCivico m730:Frazione m730:PrimaPresentazione</p>

element **Frontespizio_730_Type/DomicilioFiscaleSaldo**

<p>diagram</p>	
<p>type</p>	<p>m730:Domicilio_Fiscale_Type</p>
<p>children</p>	<p>m730:Comune m730:Provincia m730:CodiceComune m730:FusioneComuni</p>

element **Frontespizio_730_Type/DomicilioFiscaleAcconto**

diagram	
type	m730:Domicilio_Fiscale_Type
children	m730:Comune m730:Provincia m730:CodiceComune m730:FusioneComuni

element **Frontespizio_730_Type/CasiParticolariAddizionale**

diagram							
type	restriction of DatoN1_Type						
facets	<table border="1"> <thead> <tr> <th>Kind</th> <th>Value</th> </tr> </thead> <tbody> <tr> <td>enumeration</td> <td>1</td> </tr> <tr> <td>enumeration</td> <td>2</td> </tr> </tbody> </table>	Kind	Value	enumeration	1	enumeration	2
Kind	Value						
enumeration	1						
enumeration	2						

element **Frontespizio_730_Type/Firma**

diagram	
type	m730:Firma_Dichiarazione_Type
children	m730:NumeroModelli m730:FirmaDichiarazione m730:OpzioneInformativa m730:SoggettoFiscalmenteCarico

complexType Frontespizio_Con_Type

<p>diagram</p>	
<p>type</p>	<p>extension of m730:Frontespizio_730_Type</p>
<p>children</p>	<p>m730:SoggettoFiscale m730:DatiAnagrafici m730:StatoCivile m730:ResidenzaAnagrafica m730:DomicilioFiscaleSaldo m730:DomicilioFiscaleAcconto m730:CasiParticolariAddizionale m730:Firma</p>

complexType Frontespizio_Dich_Type

<p>diagram</p>	
<p>type</p>	<p>extension of m730:Frontespizio_730_Type</p>

children	m730:SoggettoFiscale m730:DatiAnagrafici m730:StatoCivile m730:ResidenzaAnagrafica m730:DomicilioFiscaleSaldo m730:DomicilioFiscaleAcconto m730:CasiParticolariAddizionale m730:Firma m730:Rappresentante m730:SpazioServiziTelematici
----------	--

element **Frontespizio_Dich_Type/Rappresentante**

diagram	
type	m730:Rappresentante_Type
children	m730:SoggettoFiscale m730:DatiAnagrafici m730:ResidenzaAnagrafica m730:Firma m730:DataCaricaErede

element **Frontespizio_Dich_Type/SpazioServiziTelematici**

diagram	
type	DatoAN_Type

complexType **Fuori_Assistenza_Type**

diagram	
children	m730:AnomaliaDatianagrafici m730:AnomaliaTerreni m730:AnomaliaFabbricati m730:AnomaliaLavDip m730:AnomaliaAltriRedditi m730:AnomaliaQuadroF

element **Fuori_Assistenza_Type/AnomaliaDatianagrafici**

diagram	
type	DatoCB_Type

element **Fuori_Assistenza_Type/AnomaliaTerreni**

diagram	
type	DatoCB_Type

element **Fuori_Assistenza_Type/AnomaliaFabbricati**

diagram	
type	DatoCB_Type

element **Fuori_Assistenza_Type/AnomaliaLavDip**

diagram	
type	DatoCB_Type

element **Fuori_Assistenza_Type/AnomaliaAltriRedditi**

diagram	
type	DatoCB_Type

element **Fuori_Assistenza_Type/AnomaliaQuadroF**

diagram	
type	DatoCB_Type

complexType **Giorni_Percentuale_Type**

diagram	
children	m730:Giorni m730:Percentuale

element **Giorni_Percentuale_Type/Giorni**

diagram	
type	DatoNP_Type

element **Giorni_Percentuale_Type/Percentuale**

diagram	
type	DatoPC_Type

complexType **Importi_Rimborsare_730-4_Integrativo_Type**

diagram	
type	extension of m730:Importi_Rimborsare_730-4_Type
children	m730:IrpefRimborsare m730:AddRegRimborsare m730:AddComRimborsare m730:CedolareRimborsare m730:TassazioneSepRimborsare m730:PremiRisultatoRimborsare

element **Importi_Rimborsare_730-4_Integrativo_Type/TassazioneSepRimborsare**

diagram	
type	m730:Importo_730-4

children	m730:ImportoDichiarante m730:ImportoConiuge m730:ImportoTotale
----------	--

element **Importi_Rimborsare_730-4_Integrativo_Type/PremiRisultatoRimborsare**

diagram	
type	m730:Importo_730-4
children	m730:ImportoDichiarante m730:ImportoConiuge m730:ImportoTotale

complexType **Importi_Rimborsare_730-4_Type**

diagram	
children	m730:IrpefRimborsare m730:AddRegRimborsare m730:AddComRimborsare m730:CedolareRimborsare

element **Importi_Rimborsare_730-4_Type/IrpefRimborsare**

diagram	
type	m730:Importo_730-4
children	m730:ImportoDichiarante m730:ImportoConiuge m730:ImportoTotale

element **Importi_Rimborsare_730-4_Type/AddRegRimborsare**

diagram	
children	m730:ImportoAddizionale m730:CodiceRegioneDichiarante m730:CodiceRegioneConiuge

element **Importi_Rimborsare_730-4_Type/AddRegRimborsare/ImportoAddizionale**

diagram	
type	m730:Importo_730-4
children	m730:ImportoDichiarante m730:ImportoConiuge m730:ImportoTotale

element **Importi_Rimborsare_730-4_Type/AddRegRimborsare/CodiceRegioneDichiarante**

diagram																																													
type	Codice_Regione_Type																																												
facets	<table border="1"> <thead> <tr> <th>Kind</th> <th>Value</th> </tr> </thead> <tbody> <tr><td>enumeration</td><td>1</td></tr> <tr><td>enumeration</td><td>2</td></tr> <tr><td>enumeration</td><td>3</td></tr> <tr><td>enumeration</td><td>4</td></tr> <tr><td>enumeration</td><td>5</td></tr> <tr><td>enumeration</td><td>6</td></tr> <tr><td>enumeration</td><td>7</td></tr> <tr><td>enumeration</td><td>8</td></tr> <tr><td>enumeration</td><td>9</td></tr> <tr><td>enumeration</td><td>10</td></tr> <tr><td>enumeration</td><td>11</td></tr> <tr><td>enumeration</td><td>12</td></tr> <tr><td>enumeration</td><td>13</td></tr> <tr><td>enumeration</td><td>14</td></tr> <tr><td>enumeration</td><td>15</td></tr> <tr><td>enumeration</td><td>16</td></tr> <tr><td>enumeration</td><td>17</td></tr> <tr><td>enumeration</td><td>18</td></tr> <tr><td>enumeration</td><td>19</td></tr> <tr><td>enumeration</td><td>20</td></tr> <tr><td>enumeration</td><td>21</td></tr> </tbody> </table>	Kind	Value	enumeration	1	enumeration	2	enumeration	3	enumeration	4	enumeration	5	enumeration	6	enumeration	7	enumeration	8	enumeration	9	enumeration	10	enumeration	11	enumeration	12	enumeration	13	enumeration	14	enumeration	15	enumeration	16	enumeration	17	enumeration	18	enumeration	19	enumeration	20	enumeration	21
Kind	Value																																												
enumeration	1																																												
enumeration	2																																												
enumeration	3																																												
enumeration	4																																												
enumeration	5																																												
enumeration	6																																												
enumeration	7																																												
enumeration	8																																												
enumeration	9																																												
enumeration	10																																												
enumeration	11																																												
enumeration	12																																												
enumeration	13																																												
enumeration	14																																												
enumeration	15																																												
enumeration	16																																												
enumeration	17																																												
enumeration	18																																												
enumeration	19																																												
enumeration	20																																												
enumeration	21																																												

element **Importi_Rimborsare_730-4_Type/AddRegRimborsare/CodiceRegioneConiuge**

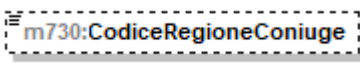
diagram																																													
type	Codice Regione Type																																												
facets	<table border="1"> <thead> <tr> <th>Kind</th> <th>Value</th> </tr> </thead> <tbody> <tr><td>enumeration</td><td>1</td></tr> <tr><td>enumeration</td><td>2</td></tr> <tr><td>enumeration</td><td>3</td></tr> <tr><td>enumeration</td><td>4</td></tr> <tr><td>enumeration</td><td>5</td></tr> <tr><td>enumeration</td><td>6</td></tr> <tr><td>enumeration</td><td>7</td></tr> <tr><td>enumeration</td><td>8</td></tr> <tr><td>enumeration</td><td>9</td></tr> <tr><td>enumeration</td><td>10</td></tr> <tr><td>enumeration</td><td>11</td></tr> <tr><td>enumeration</td><td>12</td></tr> <tr><td>enumeration</td><td>13</td></tr> <tr><td>enumeration</td><td>14</td></tr> <tr><td>enumeration</td><td>15</td></tr> <tr><td>enumeration</td><td>16</td></tr> <tr><td>enumeration</td><td>17</td></tr> <tr><td>enumeration</td><td>18</td></tr> <tr><td>enumeration</td><td>19</td></tr> <tr><td>enumeration</td><td>20</td></tr> <tr><td>enumeration</td><td>21</td></tr> </tbody> </table>	Kind	Value	enumeration	1	enumeration	2	enumeration	3	enumeration	4	enumeration	5	enumeration	6	enumeration	7	enumeration	8	enumeration	9	enumeration	10	enumeration	11	enumeration	12	enumeration	13	enumeration	14	enumeration	15	enumeration	16	enumeration	17	enumeration	18	enumeration	19	enumeration	20	enumeration	21
Kind	Value																																												
enumeration	1																																												
enumeration	2																																												
enumeration	3																																												
enumeration	4																																												
enumeration	5																																												
enumeration	6																																												
enumeration	7																																												
enumeration	8																																												
enumeration	9																																												
enumeration	10																																												
enumeration	11																																												
enumeration	12																																												
enumeration	13																																												
enumeration	14																																												
enumeration	15																																												
enumeration	16																																												
enumeration	17																																												
enumeration	18																																												
enumeration	19																																												
enumeration	20																																												
enumeration	21																																												

element **Importi_Rimborsare_730-4_Type/AddComRimborsare**

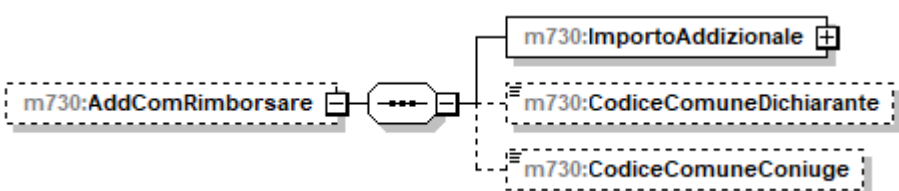
diagram	
children	m730:ImportoAddizionale m730:CodiceComuneDichiarante m730:CodiceComuneConiuge

element **Importi_Rimborsare_730-4_Type/AddComRimborsare/ImportoAddizionale**

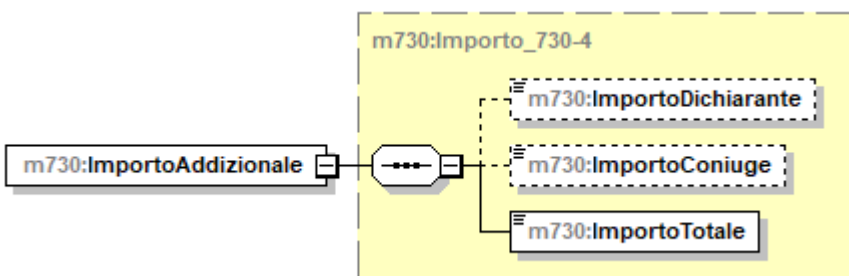
diagram	
type	m730:Importo_730-4
children	m730:ImportoDichiarante m730:ImportoConiuge m730:ImportoTotale

element **Importi_Rimborsare_730-4_Type/AddComRimborsare/CodiceComuneDichiarante**

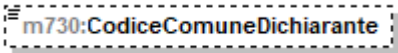
diagram	
type	DatoAN_Type

element **Importi_Rimborsare_730-4_Type/AddComRimborsare/CodiceComuneConiuge**

diagram	
type	DatoAN_Type

element **Importi_Rimborsare_730-4_Type/CedolareRimborsare**

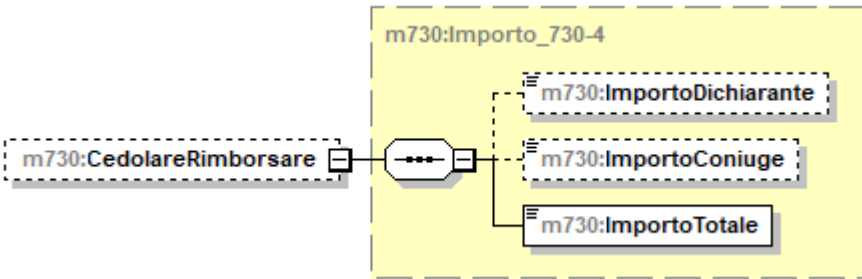
diagram	
type	m730:Importo_730-4
children	m730:ImportoDichiarante m730:ImportoConiuge m730:ImportoTotale

complexType **Importi_Trattenere_730-4_Type**

<p>diagram</p>	
<p>children</p>	<p>m730:IrpefTrattenere m730:AddRegTrattenere m730:AddComTrattenere m730:IrpefPrimaRataTrattenere m730:IrpefSecondaRataTrattenere m730:TassSepAccontoTrattene... m730:AddComAccontoTrattene... m730:PremiRisultatoTrattenere m730:CedolareTrattenere m730:CedolarePrimaRataTratte... m730:CedolareSecondaRataTrattenere</p>

element **Importi_Trattenere_730-4_Type/IrpefTrattenere**

<p>diagram</p>	
<p>type</p>	<p>m730:Importo_730-4</p>
<p>children</p>	<p>m730:ImportoDichiarante m730:ImportoConiuge m730:ImportoTotale</p>

element **Importi_Trattenere_730-4_Type/AddRegTrattenere**

diagram	
children	m730:ImportoAddizionale m730:CodiceRegioneDichiarante m730:CodiceRegioneConiuge

element **Importi_Trattenere_730-4_Type/AddRegTrattenere/ImportoAddizionale**

diagram	
type	m730:Importo_730-4
children	m730:ImportoDichiarante m730:ImportoConiuge m730:ImportoTotale

element **Importi_Trattenere_730-4_Type/AddRegTrattenere/CodiceRegioneDichiarante**

diagram																																													
type	Codice_Regione_Type																																												
facets	<table border="1"> <thead> <tr> <th>Kind</th> <th>Value</th> </tr> </thead> <tbody> <tr><td>enumeration</td><td>1</td></tr> <tr><td>enumeration</td><td>2</td></tr> <tr><td>enumeration</td><td>3</td></tr> <tr><td>enumeration</td><td>4</td></tr> <tr><td>enumeration</td><td>5</td></tr> <tr><td>enumeration</td><td>6</td></tr> <tr><td>enumeration</td><td>7</td></tr> <tr><td>enumeration</td><td>8</td></tr> <tr><td>enumeration</td><td>9</td></tr> <tr><td>enumeration</td><td>10</td></tr> <tr><td>enumeration</td><td>11</td></tr> <tr><td>enumeration</td><td>12</td></tr> <tr><td>enumeration</td><td>13</td></tr> <tr><td>enumeration</td><td>14</td></tr> <tr><td>enumeration</td><td>15</td></tr> <tr><td>enumeration</td><td>16</td></tr> <tr><td>enumeration</td><td>17</td></tr> <tr><td>enumeration</td><td>18</td></tr> <tr><td>enumeration</td><td>19</td></tr> <tr><td>enumeration</td><td>20</td></tr> <tr><td>enumeration</td><td>21</td></tr> </tbody> </table>	Kind	Value	enumeration	1	enumeration	2	enumeration	3	enumeration	4	enumeration	5	enumeration	6	enumeration	7	enumeration	8	enumeration	9	enumeration	10	enumeration	11	enumeration	12	enumeration	13	enumeration	14	enumeration	15	enumeration	16	enumeration	17	enumeration	18	enumeration	19	enumeration	20	enumeration	21
Kind	Value																																												
enumeration	1																																												
enumeration	2																																												
enumeration	3																																												
enumeration	4																																												
enumeration	5																																												
enumeration	6																																												
enumeration	7																																												
enumeration	8																																												
enumeration	9																																												
enumeration	10																																												
enumeration	11																																												
enumeration	12																																												
enumeration	13																																												
enumeration	14																																												
enumeration	15																																												
enumeration	16																																												
enumeration	17																																												
enumeration	18																																												
enumeration	19																																												
enumeration	20																																												
enumeration	21																																												

element **Importi Trattenere 730-4_Type/AddRegTrattenere/CodiceRegioneConiuge**

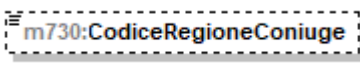
diagram		
type	Codice Regione Type	
facets	Kind	Value
	enumeration	1
	enumeration	2
	enumeration	3
	enumeration	4
	enumeration	5
	enumeration	6
	enumeration	7
	enumeration	8
	enumeration	9
	enumeration	10
	enumeration	11
	enumeration	12
	enumeration	13
	enumeration	14
	enumeration	15
	enumeration	16
	enumeration	17
	enumeration	18
	enumeration	19
	enumeration	20
	enumeration	21

element **Importi Trattenere 730-4_Type/AddComTrattenere**

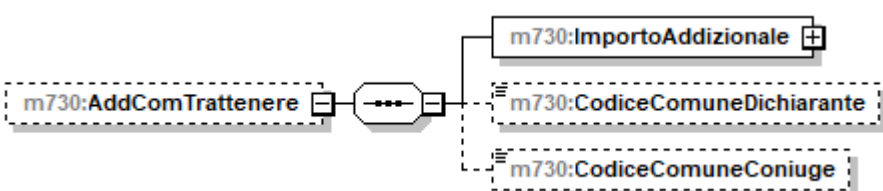
diagram		
children	m730:ImportoAddizionale m730:CodiceComuneDichiarante m730:CodiceComuneConiuge	

element **Importi Trattenere 730-4_Type/AddComTrattenere/ImportoAddizionale**

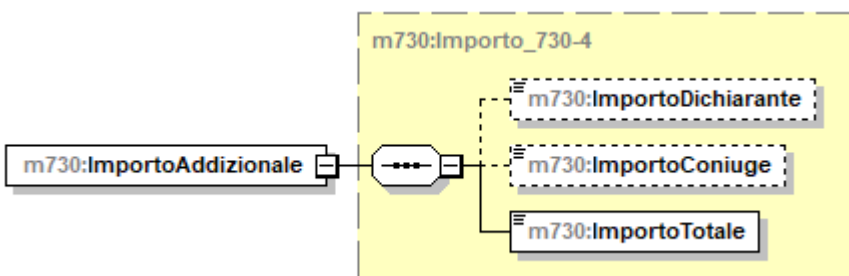
diagram		
type	m730:Importo 730-4	
children	m730:ImportoDichiarante m730:ImportoConiuge m730:ImportoTotale	

element **Importi_Trattenere_730-4_Type/AddComTrattenere/CodiceComuneDichiarante**

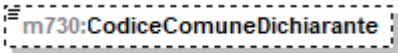
diagram	
type	DatoAN_Type

element **Importi_Trattenere_730-4_Type/AddComTrattenere/CodiceComuneConiuge**

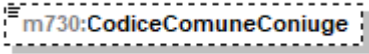
diagram	
type	DatoAN_Type

element **Importi_Trattenere_730-4_Type/IrpefPrimaRataTrattenere**

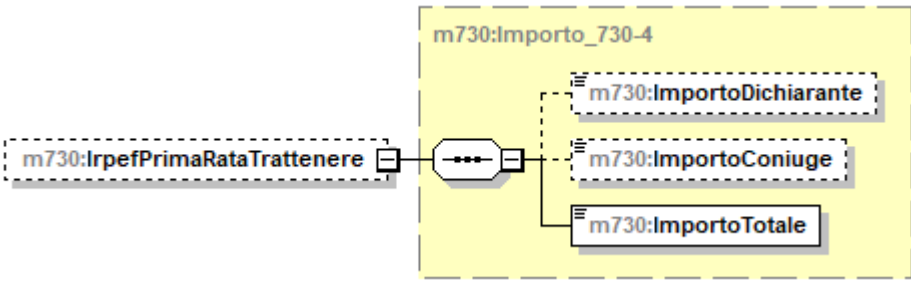
diagram	
type	m730:Importo_730-4
children	m730:ImportoDichiarante m730:ImportoConiuge m730:ImportoTotale

element **Importi_Trattenere_730-4_Type/IrpefSecondaRataTrattenere**

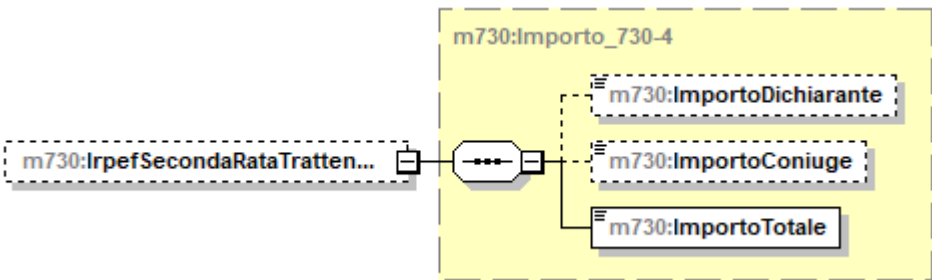
diagram	
type	m730:Importo_730-4
children	m730:ImportoDichiarante m730:ImportoConiuge m730:ImportoTotale

element **Importi_Tratenere_730-4_Type/TassSepAccontoTrattenere**

diagram	
type	m730:Importo_730-4
children	m730:ImportoDichiarante m730:ImportoConiuge m730:ImportoTotale

element **Importi_Tratenere_730-4_Type/AddComAccontoTrattenere**

diagram	
children	m730:ImportoAddizionale m730:CodiceComuneDichiarante m730:CodiceComuneConiuge

element **Importi_Tratenere_730-4_Type/AddComAccontoTrattenere/ImportoAddizionale**

diagram	
type	m730:Importo_730-4
children	m730:ImportoDichiarante m730:ImportoConiuge m730:ImportoTotale

element **Importi_Tratenere_730-4_Type/AddComAccontoTrattenere/CodiceComuneDichiarante**

diagram	
type	DatoAN_Type

element **Importi_Trattenere_730-4_Type/AddComAccontoTrattenere/CodiceComuneConiuge**

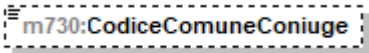
diagram	
type	DatoAN_Type

element **Importi_Trattenere_730-4_Type/PremiRisultatoTrattenere**

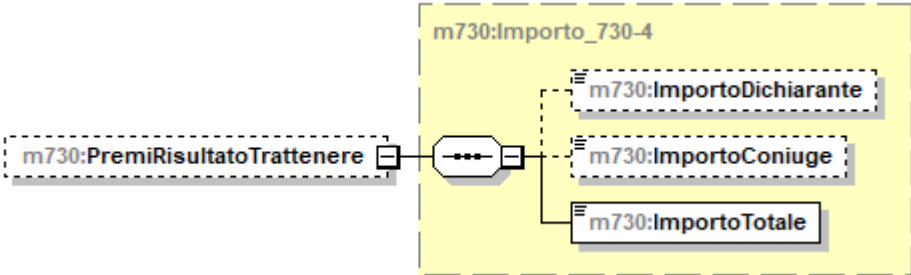
diagram	
type	m730:Importo_730-4
children	m730:ImportoDichiarante m730:ImportoConiuge m730:ImportoTotale

element **Importi_Trattenere_730-4_Type/CedolareTrattenere**

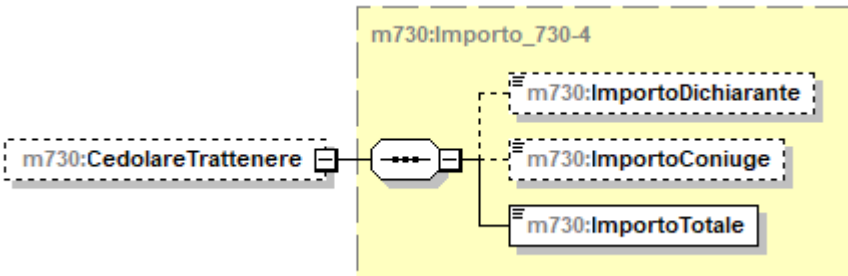
diagram	
type	m730:Importo_730-4
children	m730:ImportoDichiarante m730:ImportoConiuge m730:ImportoTotale

element **Importi_Trattenere_730-4_Type/CedolarePrimaRataTrattenere**

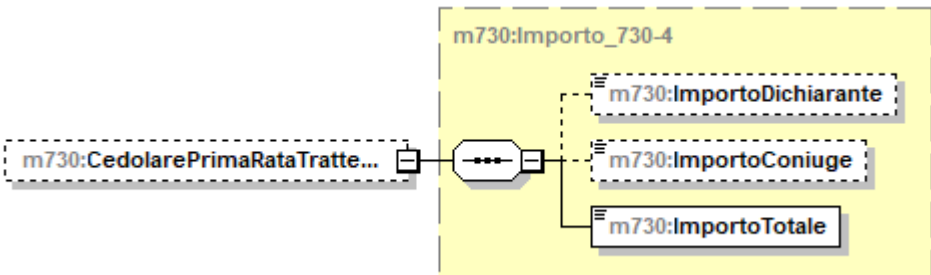
diagram	
type	m730:Importo_730-4
children	m730:ImportoDichiarante m730:ImportoConiuge m730:ImportoTotale

element **Importi_Trattenere_730-4_Type/CedolareSecondaRataTrattenere**

diagram	
type	m730:Importo_730-4
children	m730:ImportoDichiarante m730:ImportoConiuge m730:ImportoTotale

complexType **Importo_730-4**

diagram	
children	m730:ImportoDichiarante m730:ImportoConiuge m730:ImportoTotale

element **Importo_730-4/ImportoDichiarante**

diagram	
type	DatoNP_Type

element **Importo_730-4/ImportoConiuge**

diagram	
type	DatoNP_Type

element **Importo_730-4/ImportoTotale**

diagram	
type	DatoNP_Type

complexType **Imposta_Lorda_Type**

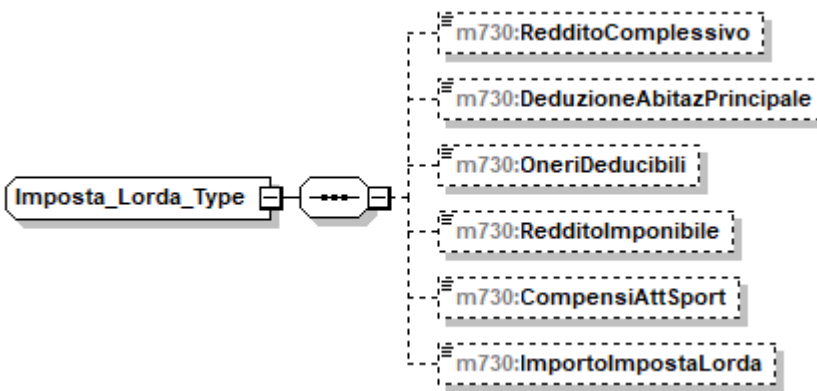
<p>diagram</p>	
<p>children</p>	<p>m730:RedditoComplessivo m730:DeduzioneAbitazPrincipale m730:OneriDeducibili m730:RedditoImponibile m730:CompensiAttSport m730:ImportoImpostaLorda</p>

element **Imposta_Lorda_Type/RedditoComplessivo**

<p>diagram</p>	
<p>type</p>	<p>DatoNP_Type</p>

element **Imposta_Lorda_Type/DeduzioneAbitazPrincipale**

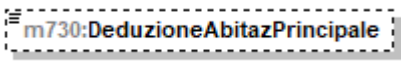
<p>diagram</p>	
<p>type</p>	<p>DatoNP_Type</p>

element **Imposta_Lorda_Type/OneriDeducibili**

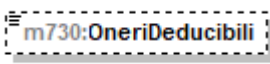
<p>diagram</p>	
<p>type</p>	<p>DatoNP_Type</p>

element **Imposta_Lorda_Type/RedditoImponibile**

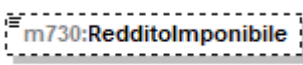
<p>diagram</p>	
<p>type</p>	<p>DatoNP_Type</p>

element **Imposta_Lorda_Type/CompensiAttSport**

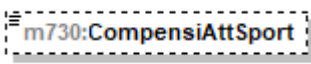
<p>diagram</p>	
----------------	---

type	DatoNP_Type
------	-----------------------------

element **Imposta_Lorda_Type/ImportoImpostaLorda**

diagram	
type	DatoNP_Type

complexType **Imposta_Netta_Type**

diagram	
children	m730:ImportoImpostaNetta m730:CredAltriSisma m730:CredAbitazSisma m730:CredImpEstere m730:CredErogCultura m730:CredErogScuola m730:CredVideosorveglianza m730:AltriCrediti m730:CredDetrazIncapienti m730:Ritenute m730:Differenza m730:EccedenzaIrpéf m730:AccontiVersati m730:CredRimborsatiSost m730:TrattamentoIntSpettante m730:TrattamentoIntRiconosciuto m730:RestituzioneTrattamentoInt

element **Imposta_Netta_Type/ImportoImpostaNetta**

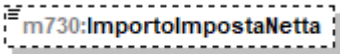
diagram	
type	DatoNP_Type

element **Imposta_Netta_Type/CredAltriSisma**

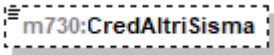
diagram	
type	DatoNP_Type

element **Imposta_Netta_Type/CredAbitazSisma**

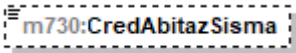
diagram	
type	DatoNP_Type

element **Imposta_Netta_Type/CredImpEstere**

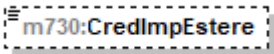
diagram	
type	DatoNP_Type

element **Imposta_Netta_Type/CredErogCultura**

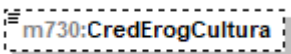
diagram	
type	DatoNP_Type

element **Imposta_Netta_Type/CredErogScuola**

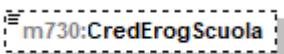
diagram	
type	DatoNP_Type

element **Imposta_Netta_Type/CredVideosorveglianza**

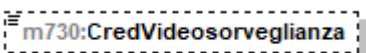
diagram	
type	DatoNP_Type

element **Imposta_Netta_Type/AltriCrediti**

diagram	
type	DatoNP_Type

element **Imposta_Netta_Type/CredDetrazIncapienti**

diagram	
type	DatoNP_Type

element **Imposta_Netta_Type/Ritenute**

diagram	
type	DatoNP_Type

element **Imposta_Netta_Type/Differenza**

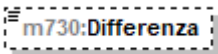
diagram	
type	DatoNU_Type

element **Imposta_Netta_Type/EccedenzaIrpéf**

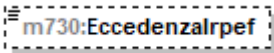
diagram	
type	DatoNU_Type

element **Imposta_Netta_Type/AccontiVersati**

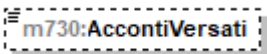
diagram	
type	DatoNP_Type

element **Imposta_Netta_Type/CredRimborsatiSost**

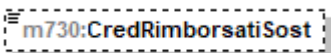
diagram	
type	DatoNP_Type

element **Imposta_Netta_Type/TrattamentoIntSpettante**

diagram	
type	DatoNP_Type

element **Imposta_Netta_Type/TrattamentoIntRiconosciuto**

diagram	
type	DatoNP_Type

element **Imposta_Netta_Type/RestituzioneTrattamentoInt**

diagram	
type	DatoNP_Type

complexType **Imposte_Rimborsate_Type**

diagram	
children	m730:TipoReddito m730:TassazioneSeparata

element **Imposte_Rimborsate_Type/TipoReddito**

diagram																			
type	m730:Tipo_Reddito_Da1a8_Type																		
facets	<table border="1"> <thead> <tr> <th>Kind</th> <th>Value</th> </tr> </thead> <tbody> <tr><td>enumeration</td><td>1</td></tr> <tr><td>enumeration</td><td>2</td></tr> <tr><td>enumeration</td><td>3</td></tr> <tr><td>enumeration</td><td>4</td></tr> <tr><td>enumeration</td><td>5</td></tr> <tr><td>enumeration</td><td>6</td></tr> <tr><td>enumeration</td><td>7</td></tr> <tr><td>enumeration</td><td>8</td></tr> </tbody> </table>	Kind	Value	enumeration	1	enumeration	2	enumeration	3	enumeration	4	enumeration	5	enumeration	6	enumeration	7	enumeration	8
Kind	Value																		
enumeration	1																		
enumeration	2																		
enumeration	3																		
enumeration	4																		
enumeration	5																		
enumeration	6																		
enumeration	7																		
enumeration	8																		

element **Imposte_Rimborsate_Type/TassazioneSeparata**

diagram	
type	m730:Tassazione_Separata_Type
children	m730:Opzione m730:Anno m730:RedditoRitenute

complexType **Inquilini_Abitazione_Principale_Type**

diagram	
children	m730:Tipologia m730:GiorniPercentuale m730:Canone

element **Inquilini_Abitazione_Principale_Type/Tipologia**

diagram									
type	m730:Tipo_Inquilino_Type								
facets	<table border="1"> <thead> <tr> <th>Kind</th> <th>Value</th> </tr> </thead> <tbody> <tr> <td>enumeration</td> <td>1</td> </tr> <tr> <td>enumeration</td> <td>2</td> </tr> <tr> <td>enumeration</td> <td>4</td> </tr> </tbody> </table>	Kind	Value	enumeration	1	enumeration	2	enumeration	4
Kind	Value								
enumeration	1								
enumeration	2								
enumeration	4								

element **Inquilini_Abitazione_Principale_Type/GiorniPercentuale**

diagram	
type	m730:Giorni_Percentuale_Type
children	m730:Giorni m730:Percentuale

element **Inquilini_Abitazione_Principale_Type/Canone**

diagram	
type	DatoNP_Type

complexType **Intervento_Recupero_Patrimonio_Edilizio_Type**

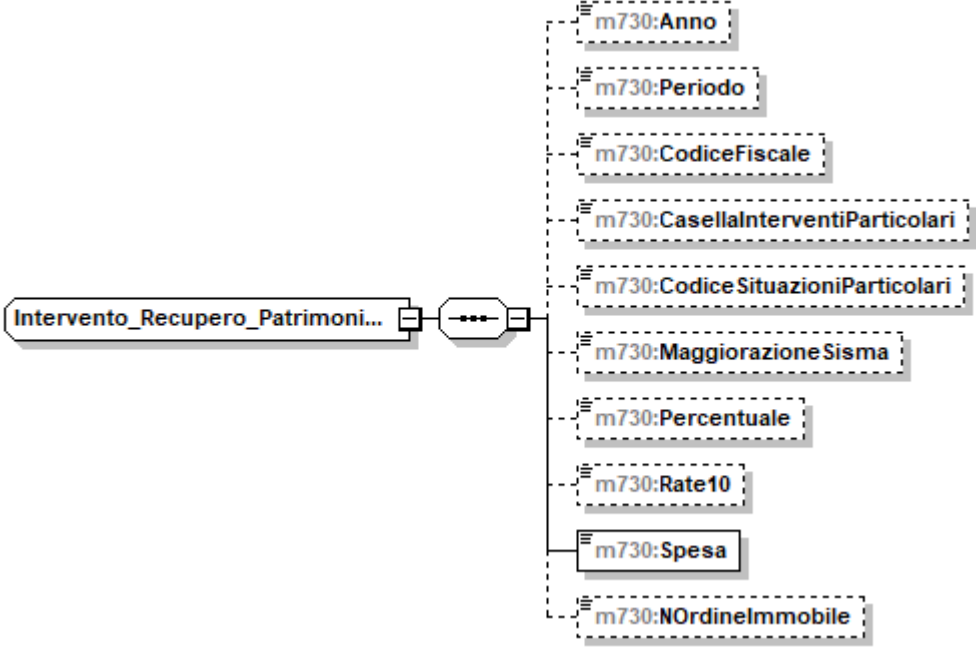
diagram	
children	m730:Anno m730:Periodo m730:CodiceFiscale m730:CasellaInterventiParticolari m730:CodiceSituazioniParticolari m730:MaggiorazioneSisma m730:Percentuale m730:Rate10 m730:Spesa m730:NOordinelImmobile

element **Intervento_Recupero_Patrimonio_Edilizio_Type/Anno**

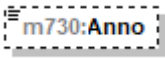
diagram																							
type	m730:Anno_Recupero_Patrimonio_Edilizio_Type																						
facets	<table border="1"> <thead> <tr> <th>Kind</th> <th>Value</th> </tr> </thead> <tbody> <tr><td>enumeration</td><td>2014</td></tr> <tr><td>enumeration</td><td>2015</td></tr> <tr><td>enumeration</td><td>2016</td></tr> <tr><td>enumeration</td><td>2017</td></tr> <tr><td>enumeration</td><td>2018</td></tr> <tr><td>enumeration</td><td>2019</td></tr> <tr><td>enumeration</td><td>2020</td></tr> <tr><td>enumeration</td><td>2021</td></tr> <tr><td>enumeration</td><td>2022</td></tr> <tr><td>enumeration</td><td>2023</td></tr> </tbody> </table>	Kind	Value	enumeration	2014	enumeration	2015	enumeration	2016	enumeration	2017	enumeration	2018	enumeration	2019	enumeration	2020	enumeration	2021	enumeration	2022	enumeration	2023
Kind	Value																						
enumeration	2014																						
enumeration	2015																						
enumeration	2016																						
enumeration	2017																						
enumeration	2018																						
enumeration	2019																						
enumeration	2020																						
enumeration	2021																						
enumeration	2022																						
enumeration	2023																						

element **Intervento_Ricupero_Patrimonio_Edilizio_Type/Periodo**

diagram																																											
type	m730:Periodo Spese Ristrutturazione Type																																										
facets	<table border="1"> <thead> <tr> <th>Kind</th> <th>Value</th> </tr> </thead> <tbody> <tr><td>enumeration</td><td>2</td></tr> <tr><td>enumeration</td><td>3</td></tr> <tr><td>enumeration</td><td>4</td></tr> <tr><td>enumeration</td><td>5</td></tr> <tr><td>enumeration</td><td>6</td></tr> <tr><td>enumeration</td><td>7</td></tr> <tr><td>enumeration</td><td>8</td></tr> <tr><td>enumeration</td><td>9</td></tr> <tr><td>enumeration</td><td>10</td></tr> <tr><td>enumeration</td><td>11</td></tr> <tr><td>enumeration</td><td>12</td></tr> <tr><td>enumeration</td><td>13</td></tr> <tr><td>enumeration</td><td>15</td></tr> <tr><td>enumeration</td><td>16</td></tr> <tr><td>enumeration</td><td>17</td></tr> <tr><td>enumeration</td><td>18</td></tr> <tr><td>enumeration</td><td>19</td></tr> <tr><td>enumeration</td><td>20</td></tr> <tr><td>enumeration</td><td>21</td></tr> <tr><td>enumeration</td><td>22</td></tr> </tbody> </table>	Kind	Value	enumeration	2	enumeration	3	enumeration	4	enumeration	5	enumeration	6	enumeration	7	enumeration	8	enumeration	9	enumeration	10	enumeration	11	enumeration	12	enumeration	13	enumeration	15	enumeration	16	enumeration	17	enumeration	18	enumeration	19	enumeration	20	enumeration	21	enumeration	22
Kind	Value																																										
enumeration	2																																										
enumeration	3																																										
enumeration	4																																										
enumeration	5																																										
enumeration	6																																										
enumeration	7																																										
enumeration	8																																										
enumeration	9																																										
enumeration	10																																										
enumeration	11																																										
enumeration	12																																										
enumeration	13																																										
enumeration	15																																										
enumeration	16																																										
enumeration	17																																										
enumeration	18																																										
enumeration	19																																										
enumeration	20																																										
enumeration	21																																										
enumeration	22																																										

element **Intervento_Ricupero_Patrimonio_Edilizio_Type/CodiceFiscale**

diagram	
type	DatoCF Type

element **Intervento_Ricupero_Patrimonio_Edilizio_Type/CasellaInterventiParticolari**

diagram							
type	restriction of DatoN1 Type						
facets	<table border="1"> <thead> <tr> <th>Kind</th> <th>Value</th> </tr> </thead> <tbody> <tr><td>enumeration</td><td>1</td></tr> <tr><td>enumeration</td><td>4</td></tr> </tbody> </table>	Kind	Value	enumeration	1	enumeration	4
Kind	Value						
enumeration	1						
enumeration	4						

element **Intervento_Ricupero_Patrimonio_Edilizio_Type/CodiceSituazioniParticolari**

diagram					
type	restriction of DatoN1 Type				
facets	<table border="1"> <thead> <tr> <th>Kind</th> <th>Value</th> </tr> </thead> <tbody> <tr><td>enumeration</td><td>4</td></tr> </tbody> </table>	Kind	Value	enumeration	4
Kind	Value				
enumeration	4				

element **Intervento_Ricupero_Patrimonio_Edilizio_Type/MaggiorazioneSisma**

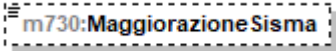
diagram	
type	DatoCB_Type

element **Intervento_Ricupero_Patrimonio_Edilizio_Type/Percentuale**

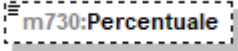
diagram							
type	restriction of DatoNP_Type						
facets	<table border="1"> <thead> <tr> <th>Kind</th> <th>Value</th> </tr> </thead> <tbody> <tr> <td>enumeration</td> <td>1</td> </tr> <tr> <td>enumeration</td> <td>2</td> </tr> </tbody> </table>	Kind	Value	enumeration	1	enumeration	2
Kind	Value						
enumeration	1						
enumeration	2						

element **Intervento_Ricupero_Patrimonio_Edilizio_Type/Rate10**

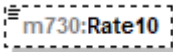
diagram																							
type	m730:Rate10_Type																						
facets	<table border="1"> <thead> <tr> <th>Kind</th> <th>Value</th> </tr> </thead> <tbody> <tr><td>enumeration</td><td>1</td></tr> <tr><td>enumeration</td><td>2</td></tr> <tr><td>enumeration</td><td>3</td></tr> <tr><td>enumeration</td><td>4</td></tr> <tr><td>enumeration</td><td>5</td></tr> <tr><td>enumeration</td><td>6</td></tr> <tr><td>enumeration</td><td>7</td></tr> <tr><td>enumeration</td><td>8</td></tr> <tr><td>enumeration</td><td>9</td></tr> <tr><td>enumeration</td><td>10</td></tr> </tbody> </table>	Kind	Value	enumeration	1	enumeration	2	enumeration	3	enumeration	4	enumeration	5	enumeration	6	enumeration	7	enumeration	8	enumeration	9	enumeration	10
Kind	Value																						
enumeration	1																						
enumeration	2																						
enumeration	3																						
enumeration	4																						
enumeration	5																						
enumeration	6																						
enumeration	7																						
enumeration	8																						
enumeration	9																						
enumeration	10																						

element **Intervento_Ricupero_Patrimonio_Edilizio_Type/Spesa**

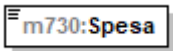
diagram	
type	DatoNP_Type

element **Intervento_Ricupero_Patrimonio_Edilizio_Type/NOrdineImmobile**

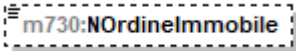
diagram	
type	DatoNP_Type

complexType **Intervento_Risparmio_Energetico_Type**

<p>diagram</p>	
<p>children</p>	<p>m730:TipIntervento m730:Anno m730:CasiParticolari m730:RideterminazioneRate m730:Percentuale m730:NumeroRata m730:Spesa m730:MaggiorazioneSisma</p>

element **Intervento_Risparmio_Energetico_Type/TipIntervento**

<p>diagram</p>																																											
<p>type</p>	<p>m730:Tipo_Intervento_Type</p>																																										
<p>facets</p>	<table border="1"> <thead> <tr> <th>Kind</th> <th>Value</th> </tr> </thead> <tbody> <tr><td>enumeration</td><td>1</td></tr> <tr><td>enumeration</td><td>2</td></tr> <tr><td>enumeration</td><td>3</td></tr> <tr><td>enumeration</td><td>4</td></tr> <tr><td>enumeration</td><td>5</td></tr> <tr><td>enumeration</td><td>6</td></tr> <tr><td>enumeration</td><td>7</td></tr> <tr><td>enumeration</td><td>8</td></tr> <tr><td>enumeration</td><td>9</td></tr> <tr><td>enumeration</td><td>10</td></tr> <tr><td>enumeration</td><td>11</td></tr> <tr><td>enumeration</td><td>12</td></tr> <tr><td>enumeration</td><td>13</td></tr> <tr><td>enumeration</td><td>14</td></tr> <tr><td>enumeration</td><td>15</td></tr> <tr><td>enumeration</td><td>16</td></tr> <tr><td>enumeration</td><td>30</td></tr> <tr><td>enumeration</td><td>31</td></tr> <tr><td>enumeration</td><td>32</td></tr> <tr><td>enumeration</td><td>33</td></tr> </tbody> </table>	Kind	Value	enumeration	1	enumeration	2	enumeration	3	enumeration	4	enumeration	5	enumeration	6	enumeration	7	enumeration	8	enumeration	9	enumeration	10	enumeration	11	enumeration	12	enumeration	13	enumeration	14	enumeration	15	enumeration	16	enumeration	30	enumeration	31	enumeration	32	enumeration	33
Kind	Value																																										
enumeration	1																																										
enumeration	2																																										
enumeration	3																																										
enumeration	4																																										
enumeration	5																																										
enumeration	6																																										
enumeration	7																																										
enumeration	8																																										
enumeration	9																																										
enumeration	10																																										
enumeration	11																																										
enumeration	12																																										
enumeration	13																																										
enumeration	14																																										
enumeration	15																																										
enumeration	16																																										
enumeration	30																																										
enumeration	31																																										
enumeration	32																																										
enumeration	33																																										

element **Intervento_Risparmio_Energetico_Type/Anno**

<p>diagram</p>					
<p>type</p>	<p>restriction of m730:Anno_Risparmio_Energetico_Type</p>				
<p>facets</p>	<table border="1"> <thead> <tr> <th>Kind</th> <th>Value</th> </tr> </thead> <tbody> <tr> <td>enumeration</td> <td>2008</td> </tr> </tbody> </table>	Kind	Value	enumeration	2008
Kind	Value				
enumeration	2008				

	enumeration	2014
	enumeration	2015
	enumeration	2016
	enumeration	2017
	enumeration	2018
	enumeration	2019
	enumeration	2020
	enumeration	2021
	enumeration	2022
	enumeration	2023

element **Intervento_Risparmio_Energetico_Type/CasiParticolari**

diagram		
type	m730:Casi Particolari Risp Ener Type	
facets	Kind	Value
	enumeration	1
	enumeration	2
	enumeration	3

element **Intervento_Risparmio_Energetico_Type/RideterminazioneRate**

diagram		
type	m730:Rate Risparmio Energetico Type	
facets	Kind	Value
	enumeration	7
	enumeration	8
	enumeration	9
	enumeration	10

element **Intervento_Risparmio_Energetico_Type/Percentuale**

diagram		
type	restriction of DatoNP_Type	
facets	Kind	Value
	enumeration	1
	enumeration	2

element **Intervento_Risparmio_Energetico_Type/NumeroRata**

diagram		
type	m730:Numero Rata Risparmio Energetico Type	
facets	Kind	Value
	enumeration	1
	enumeration	2
	enumeration	3
	enumeration	4
	enumeration	5
	enumeration	6
	enumeration	7

	enumeration 8
	enumeration 9
	enumeration 10

element **Intervento_Risparmio_Energetico_Type/Spesa**

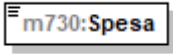
diagram	
type	DatoNP_Type

element **Intervento_Risparmio_Energetico_Type/MaggiorazioneSisma**

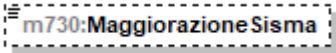
diagram	
type	DatoCB_Type

complexType **Investimenti_Estero_Type**

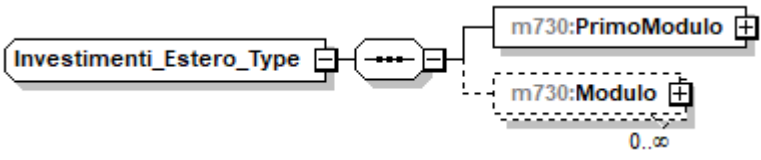
diagram	
children	m730:PrimoModulo m730:Modulo

element **Investimenti_Estero_Type/PrimoModulo**

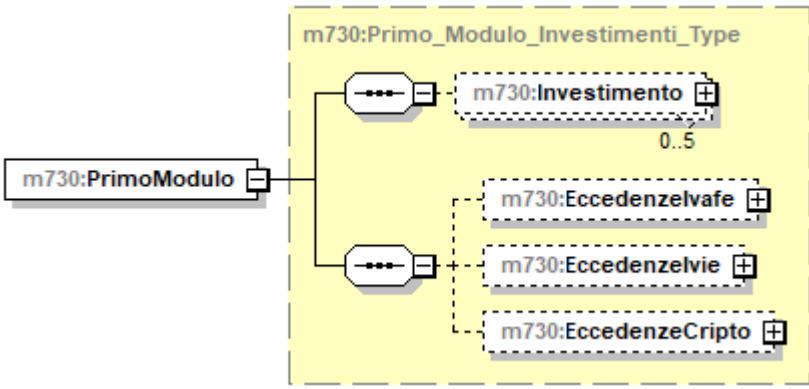
diagram	
type	m730:Primo_Modulo_Investimenti_Type
children	m730:Investimento m730:Eccedenzelvefe m730:Eccedenzelve m730:EccedenzeCripto

element **Investimenti_Estero_Type/Modulo**

diagram	<p>The diagram shows a class <code>m730:Modulo</code> with a multiplicity of <code>0..∞</code> connected to a class <code>m730:Investimento</code> with a multiplicity of <code>0..5</code>. The connection is a solid line with an open arrowhead pointing towards <code>m730:Investimento</code>. Both classes are enclosed in a dashed yellow box labeled <code>m730:Modulo_Investimenti_Type</code>.</p>
type	m730:Modulo_Investimenti_Type
children	m730:Investimento

complexType **Investimento_Type**

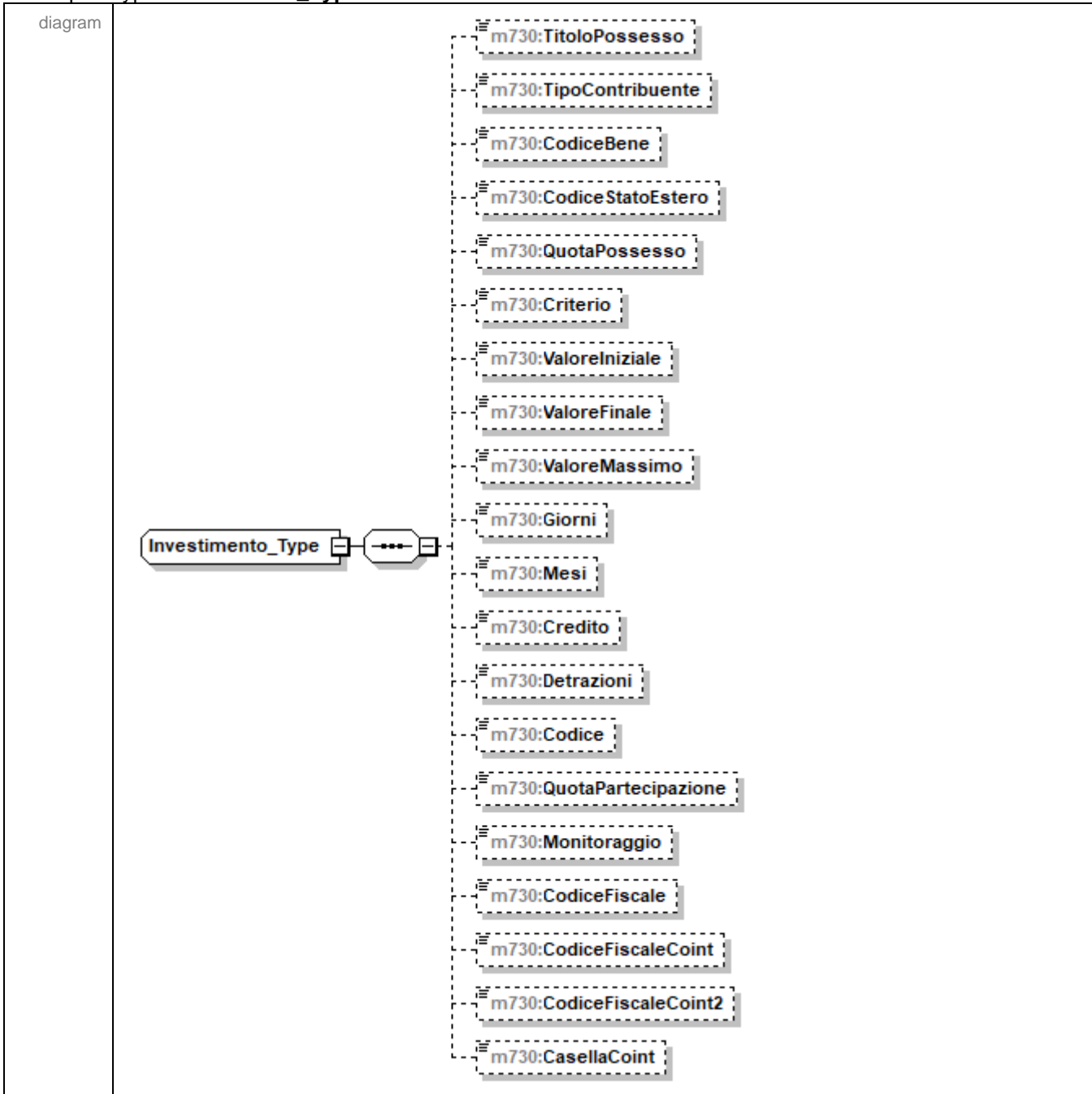

children	m730:TitoloPossesso m730:TipoContribuente m730:CodiceBene m730:CodiceStatoEstero m730:QuotaPossesso m730:Criterio m730:ValoreIniziale m730:ValoreFinale m730:ValoreMassimo m730:Giorni m730:Mesi m730:Credito m730:Detrazioni m730:Codice m730:QuotaPartecipazione m730:Monitoraggio m730:CodiceFiscale m730:CodiceFiscaleCoint m730:CodiceFiscaleCoint2 m730:CasellaCoint
----------	--

element **Investimento_Type/TitoloPossesso**



type	DatoN1_Type
------	-----------------------------

element **Investimento_Type/TipoContribuente**

diagram	 A diagram showing a dashed rectangular box containing the text "m730:TipoContribuente".
type	DatoN1_Type

element **Investimento_Type/CodiceBene**

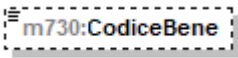
diagram	 A diagram showing a dashed rectangular box containing the text "m730:CodiceBene".
type	DatoNP_Type

element **Investimento_Type/CodiceStatoEstero**

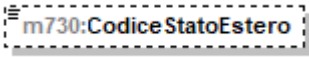
diagram	 A diagram showing a dashed rectangular box containing the text "m730:CodiceStatoEstero".
type	DatoAN_Type

element **Investimento_Type/QuotaPossesso**

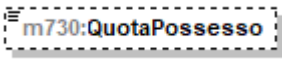
diagram	 A diagram showing a dashed rectangular box containing the text "m730:QuotaPossesso".
type	DatoPC_Type

element **Investimento_Type/Criterio**

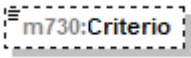
diagram	 A diagram showing a dashed rectangular box containing the text "m730:Criterio".
type	DatoN1_Type

element **Investimento_Type/ValoreIniziale**

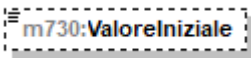
diagram	 A diagram showing a dashed rectangular box containing the text "m730:ValoreIniziale".
type	DatoNP_Type

element **Investimento_Type/ValoreFinale**

diagram	 A diagram showing a dashed rectangular box containing the text "m730:ValoreFinale".
---------	---

type	DatoNP_Type
------	-----------------------------

element **Investimento_Type/ValoreMassimo**

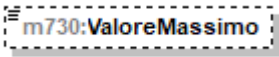
diagram	
type	DatoNP_Type

element **Investimento_Type/Giorni**

diagram	
type	DatoNP_Type

element **Investimento_Type/Mesi**

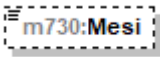
diagram	
type	DatoNP_Type

element **Investimento_Type/Credito**

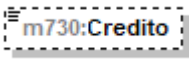
diagram	
type	DatoNP_Type

element **Investimento_Type/Detrazioni**

diagram	
type	DatoNP_Type

element **Investimento_Type/Codice**

diagram	
type	DatoN1_Type

element **Investimento_Type/QuotaPartecipazione**

diagram	
---------	---

type	DatoPC_Type
------	-----------------------------

element **Investimento_Type/Monitoraggio**

diagram	 A dashed rectangular box containing the text "m730:Monitoraggio".
type	DatoCB_Type

element **Investimento_Type/CodiceFiscale**

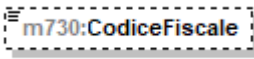
diagram	 A dashed rectangular box containing the text "m730:CodiceFiscale".
type	DatoAN_Type

element **Investimento_Type/CodiceFiscaleCoint**

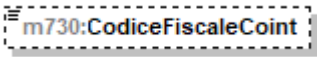
diagram	 A dashed rectangular box containing the text "m730:CodiceFiscaleCoint".
type	DatoAN_Type

element **Investimento_Type/CodiceFiscaleCoint2**

diagram	 A dashed rectangular box containing the text "m730:CodiceFiscaleCoint2".
type	DatoAN_Type

element **Investimento_Type/CasellaCoint**

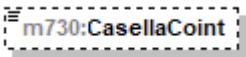
diagram	 A dashed rectangular box containing the text "m730:CasellaCoint".
type	DatoCB_Type

complexType **Iva_Acquisto_Abitazione_Type**

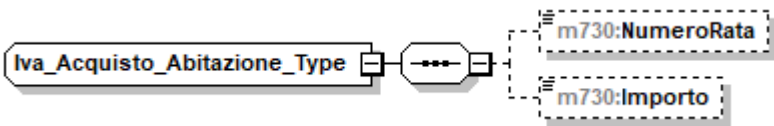
diagram	 A diagram showing a complex type structure. On the left is a rounded rectangle labeled "Iva_Acquisto_Abitazione_Type". To its right is a small octagon containing three dots. A dashed line connects the octagon to two stacked dashed rectangular boxes on the right, labeled "m730:NumeroRata" and "m730:Importo".
children	m730:NumeroRata m730:Importo

element **Iva_Acquisto_Abitazione_Type/NumeroRata**

diagram									
type	restriction of DatoNP_Type								
facets	<table border="1"> <thead> <tr> <th>Kind</th> <th>Value</th> </tr> </thead> <tbody> <tr> <td>enumeration</td> <td>1</td> </tr> <tr> <td>enumeration</td> <td>7</td> </tr> <tr> <td>enumeration</td> <td>8</td> </tr> </tbody> </table>	Kind	Value	enumeration	1	enumeration	7	enumeration	8
Kind	Value								
enumeration	1								
enumeration	7								
enumeration	8								

element **Iva_Acquisto_Abitazione_Type/Importo**

diagram	
type	DatoNP_Type

complexType **Lavoro_Dipendente_Type**

diagram	
children	m730:TipologiaReddito m730:TipoContratto m730:Reddito m730:AltriRedditi

element **Lavoro_Dipendente_Type/TipologiaReddito**

diagram																	
type	restriction of DatoN1_Type																
facets	<table border="1"> <thead> <tr> <th>Kind</th> <th>Value</th> </tr> </thead> <tbody> <tr> <td>enumeration</td> <td>1</td> </tr> <tr> <td>enumeration</td> <td>2</td> </tr> <tr> <td>enumeration</td> <td>3</td> </tr> <tr> <td>enumeration</td> <td>4</td> </tr> <tr> <td>enumeration</td> <td>7</td> </tr> <tr> <td>enumeration</td> <td>8</td> </tr> <tr> <td>enumeration</td> <td>9</td> </tr> </tbody> </table>	Kind	Value	enumeration	1	enumeration	2	enumeration	3	enumeration	4	enumeration	7	enumeration	8	enumeration	9
Kind	Value																
enumeration	1																
enumeration	2																
enumeration	3																
enumeration	4																
enumeration	7																
enumeration	8																
enumeration	9																

element **Lavoro_Dipendente_Type/TipoContratto**

diagram							
type	m730:Indeterminato_Determinato_Type						
facets	<table border="1"> <thead> <tr> <th>Kind</th> <th>Value</th> </tr> </thead> <tbody> <tr> <td>enumeration</td> <td>1</td> </tr> <tr> <td>enumeration</td> <td>2</td> </tr> </tbody> </table>	Kind	Value	enumeration	1	enumeration	2
Kind	Value						
enumeration	1						
enumeration	2						

element **Lavoro_Dipendente_Type/Reddito**

diagram	
type	DatoNP_Type

element **Lavoro_Dipendente_Type/AltriRedditi**

diagram											
type	restriction of DatoN1_Type										
facets	<table border="1"> <thead> <tr> <th>Kind</th> <th>Value</th> </tr> </thead> <tbody> <tr> <td>enumeration</td> <td>1</td> </tr> <tr> <td>enumeration</td> <td>2</td> </tr> <tr> <td>enumeration</td> <td>5</td> </tr> <tr> <td>enumeration</td> <td>6</td> </tr> </tbody> </table>	Kind	Value	enumeration	1	enumeration	2	enumeration	5	enumeration	6
Kind	Value										
enumeration	1										
enumeration	2										
enumeration	5										
enumeration	6										

complexType **Locazioni_Brevi_Type**

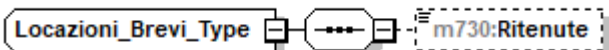
diagram	
children	m730:Ritenute

element **Locazioni_Brevi_Type/Ritenute**

diagram	
type	DatoNP_Type

complexType **Mance_Modulo_Type**

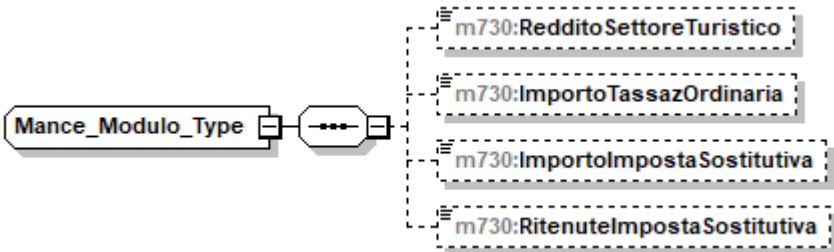
diagram	
children	m730:RedditoSettoreTuristico m730:ImportoTassazOrdinaria m730:ImportoImpostaSostitutiva m730:RitenuteImpostaSostitutiva

element **Mance_Modulo_Type/RedditoSettoreTuristico**

diagram	
type	DatoNP_Type

element **Mance_Modulo_Type/ImportoTassazOrdinaria**

diagram	
type	DatoNP_Type

element **Mance_Modulo_Type/ImportoImpostaSostitutiva**

diagram	
type	DatoNP_Type

element **Mance_Modulo_Type/RitenuteImpostaSostitutiva**

diagram	
type	DatoNP_Type

complexType **Mance_Type**

diagram	
type	extension of m730:Mance_Modulo_Type
children	m730:RedditoSettoreTuristico m730:ImportoTassazOrdinaria m730:ImportoImpostaSostitutiva m730:RitenuteImpostaSostitutiva m730:TassazOrdinaria m730:TassazSostitutiva m730:AssenzaRequisiti

element **Mance_Type/TassazOrdinaria**

diagram	
type	DatoCB_Type

element **Mance_Type/TassazSostitutiva**

diagram	
type	DatoCB_Type

element **Mance_Type/AssenzaRequisiti**

diagram	
type	DatoCB_Type

complexType **Misura_Aconti_Type**

diagram	
children	m730:IrpefMisuralInferiore m730:AddComunaleMisuralInferiore m730:CedolareSeccaMisuralInferiore m730:NumeroRate m730:CriptoAttMisuralInferiore m730:lvieMisuralInferiore m730:lvafeMisuralInferiore

element **Misura_Acconti_Type/IrpefMisuralInferiore**

diagram	
type	m730:Casella_Acconto_Type
children	m730:Casella m730:ImportoMisuralInferiore

element **Misura_Acconti_Type/AddComunaleMisuralInferiore**

diagram	
type	m730:Casella_Acconto_Type
children	m730:Casella m730:ImportoMisuralInferiore

element **Misura_Acconti_Type/CedolareSeccaMisuralInferiore**

diagram	
type	m730:Casella_Acconto_Type
children	m730:Casella m730:ImportoMisuralInferiore

element **Misura_Acconti_Type/NumeroRate**

diagram															
type	restriction of DatoN1_Type														
facets	<table border="1"> <thead> <tr> <th>Kind</th> <th>Value</th> </tr> </thead> <tbody> <tr> <td>enumeration</td> <td>2</td> </tr> <tr> <td>enumeration</td> <td>3</td> </tr> <tr> <td>enumeration</td> <td>4</td> </tr> <tr> <td>enumeration</td> <td>5</td> </tr> <tr> <td>enumeration</td> <td>6</td> </tr> <tr> <td>enumeration</td> <td>7</td> </tr> </tbody> </table>	Kind	Value	enumeration	2	enumeration	3	enumeration	4	enumeration	5	enumeration	6	enumeration	7
Kind	Value														
enumeration	2														
enumeration	3														
enumeration	4														
enumeration	5														
enumeration	6														
enumeration	7														

element **Misura_Acconti_Type/CriptoAttMisuralInferiore**

diagram	
type	m730:Casella_Acconto_Type
children	m730:Casella m730:ImportoMisuralInferiore

element **Misura_Acconti_Type/lvieMisuralInferiore**

diagram	
type	m730:Casella_Acconto_Type
children	m730:Casella m730:ImportoMisuralInferiore

element **Misura_Acconti_Type/lvafeMisuralInferiore**

diagram	
type	m730:Casella_Acconto_Type
children	m730:Casella m730:ImportoMisuralInferiore

complexType **Mod730_Integrativo_Type**

diagram	
children	m730:ImportiRimborsare m730:ImportoRimborsato m730:ImportoRimborsatoAgenzia

element **Mod730_Integrativo_Type/ImportiRimborsare**

diagram	
type	m730:Importi_Rimborsare_730-4_Integrativo_Type
children	m730:IrpefRimborsare m730:AddRegRimborsare m730:AddComRimborsare m730:CedolareRimborsare m730:TassazioneSepRimborsare m730:PremiRisultatoRimborsare

element **Mod730_Integrativo_Type/ImportoRimborsato**

diagram	
type	DatoNP_Type

element **Mod730_Integrativo_Type/ImportoRimborsatoAgenzia**

diagram	
type	DatoNP_Type

complexType **Modulo_Altri_Reddito_Type**

diagram	
children	m730:RedditiDiCapitale m730:RedditiTassazioneSeparata

element **Modulo_Altri_Reddi_Type/RedditiDiCapitale**

diagram	
type	m730:Redditi_Capitale_Type
children	m730:Utili m730:AltriRedditiDiCapitale m730:LavoroAutonomo m730:RedditiDiversi m730:RedditiDiversiDetraz

element **Modulo_Altri_Reddi_Type/RedditiTassazioneSeparata**

diagram	
type	m730:Redditi_Tassazione_Separata_Type
children	m730:RedditiErede m730:ImposteRimborsate

complexType **Modulo_Annotazioni_Type**

diagram	
children	m730:Annotazione

element **Modulo_Annotazioni_Type/Annotazione**

diagram	
type	m730:Annotazione_Type
children	m730:Codice m730:RigoQuadro m730:ModuloQuadro m730:Importo

complexType **Modulo_Communicazione_Type**

diagram	
children	m730:DatiCondominio m730:DatiCatastali m730:DomandaAccatastamento m730:DatiFornitore

element **Modulo_Communicazione_Type/DatiCondominio**

diagram	
type	m730:Dati_Condominio_Type
children	m730:CodiceFiscale m730:Denominazione

element **Modulo_Communicazione_Type/DatiCatastali**

<p>diagram</p>	
<p>type</p>	<p>m730:Dati_Catastali_Type</p>
<p>children</p>	<p>m730:CodiceComune m730:TerreniUrbano m730:SezioneUrbanaComuneCatastale m730:Foglio m730:Particella m730:Subalterno</p>

element **Modulo_Communicazione_Type/DomandaAccatastamento**

<p>diagram</p>	
<p>type</p>	<p>m730:Domanda_Accatastamento_Type</p>
<p>children</p>	<p>m730:Data m730:Numero m730:ProvinciaUfficio</p>

element **Modulo_Communicazione_Type/DatiFornitore**

diagram	
type	m730:Dati Fornitore Type
children	m730:CodiceFiscale m730:CognomeDenom m730:Nome m730:Sesso m730:DataNascita m730:ComuneNascita m730:ProvinciaNascita m730:ImportoAcquisti m730:StatoEstero

complexType **Modulo_Crediti_Imposta_Type**

diagram	
children	m730:CreditiImpostaFondiPensione m730:CreditiImpostaRedditiEsteri m730:CreditoPrimaCasaSismaAbruzzo m730:CreditoAltriSismaAbruzzo m730:AltriCreditoImposta

element **Modulo_Crediti_Imposta_Type/CreditiImpostaFondiPensione**

diagram	
type	m730:Crediti_Imposta_Fondi_Pensione_Type
children	m730:AnnoAnticipazione m730:Reintegro m730:SommaReintegrata m730:CreditoAnno

element **Modulo_Crediti_Imposta_Type/CreditiImpostaRedditiEsteri**

diagram	
type	m730:Crediti_Imposta_Redditi_Esteri_Type
children	m730:StatoEstero m730:Anno m730:RedditoEstero m730:ImpostaEstera m730:RedditoComplessivo m730:Imposta_Lorda m730:ImpostaNetta m730:CreditoDichiarazioniPrecedenti m730:DiCuiStatoEstero

element **Modulo_Crediti_Imposta_Type/CreditoPrimaCasaSismaAbruzzo**

diagram	
type	m730:Credito_Immobile_Sisma_Abruzzo_Type
children	m730:CodiceFiscale m730:NumeroRata m730:TotaleCredito

element **Modulo_Crediti_Imposta_Type/CreditoAltriSismaAbruzzo**

diagram	
type	m730:Crediti_Imposta_Altri_Sisma_Abruzzo_Type
children	m730:Impresa_Professione m730:CodiceFiscale m730:NumeroRata m730:TotaleCredito m730:Rateazione

element **Modulo_Crediti_Imposta_Type/AltriCreditoImposta**

diagram	
type	m730:Altri_Crediti_Imposta_Type
children	m730:Codice m730:Importo m730:ResiduoAnnoPrec m730:RataDueAnniPrec m730:DiCuiCompensatoF24

complexType **Modulo_Credito_Negoziatore_Type**

diagram	
children	m730:CreditoSpettante

element **Modulo_Credito_Negoziatore_Type/CreditoSpettante**

diagram	
type	DatoNP_Type

complexType **Modulo_Dati_Rettificati_Type**

diagram	
children	m730:Rettifica

element **Modulo_Dati_Rettificati_Type/Rettifica**

diagram	
type	m730:Rettifica_Type
children	m730:Quadro m730:Rigo m730:Colonna m730:Modulo m730:DatoRimosso

complexType **Modulo_Fabbricato_Type**

diagram	
---------	--

children	m730:FabbricatoOrd m730:FabbricatoAgev
----------	--

element **Modulo_Fabbricato_Type/FabbricatoOrd**

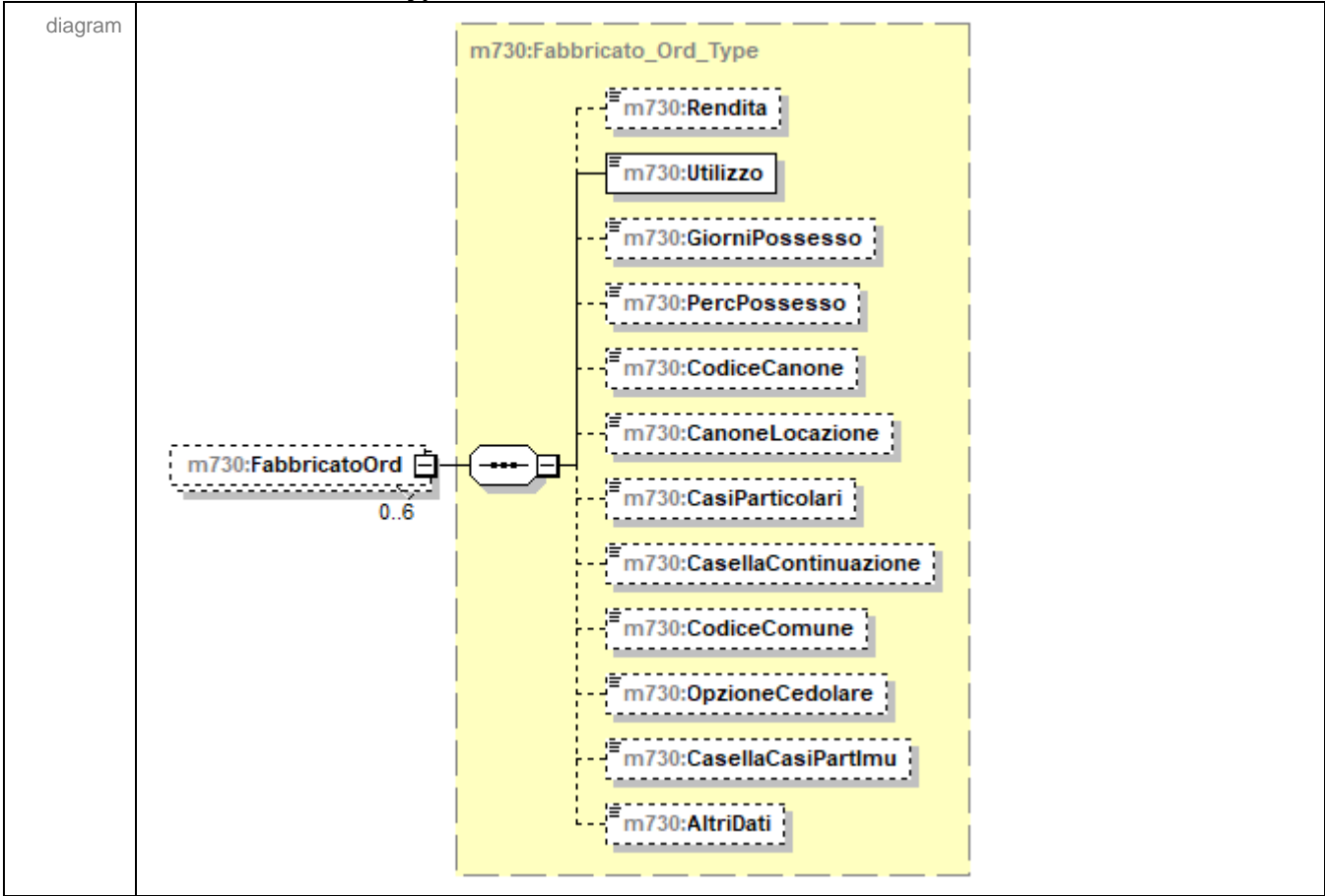

type	m730:Fabbricato_Ord_Type
------	--

children	m730:Rendita m730:Utilizzo m730:GiorniPossesso m730:PercPossesso m730:CodiceCanone m730:CanoneLocazione m730:CasiParticolari m730:CasellaContinuazione m730:CodiceComune m730:OpzioneCedolare m730:CasellaCasiPartlmu m730:AltriDati
----------	--

element **Modulo_Fabbricato_Type/FabbricatoAgev**

diagram	
type	m730:Fabbricato_Agev_Type
children	m730:NumeroRigoRiferimento m730:NumModuloRiferimento m730:DatiContratto m730:CasellaInf30Giorni m730:AnnoDichiarazioneIcilmu

complexType **Modulo_Familiari_Type**

diagram	
children	m730:Coniuge m730:PrimoFiglio m730:Familiari

element **Modulo_Familiari_Type/Coniuge**

diagram	
type	m730:Dati_Coniuge_Type
children	m730:Tipo m730:CodiceFiscale m730:Mesi

element **Modulo_Familiari_Type/PrimoFiglio**

diagram	
type	extension of m730:Dati_Familiare_Type
children	m730:CodiceFiscale m730:Mesi m730:PercDetraz m730:PercDetrazCon m730:Affidamento m730:MesiDetraz21Anni m730:Tipo

element **Modulo_Familiari_Type/PrimoFiglio/Tipo**

diagram							
type	restriction of DatoAN_Type						
facets	<table border="1"> <thead> <tr> <th>Kind</th> <th>Value</th> </tr> </thead> <tbody> <tr> <td>enumeration</td> <td>F</td> </tr> <tr> <td>enumeration</td> <td>D</td> </tr> </tbody> </table>	Kind	Value	enumeration	F	enumeration	D
Kind	Value						
enumeration	F						
enumeration	D						

element **Modulo_Familiari_Type/Familiari**

diagram	
type	extension of m730:Dati_Familiare_Type
children	m730:CodiceFiscale m730:Mesi m730:PercDetraz m730:PercDetrazCon m730:Affidamento m730:MesiDetraz21Anni m730:Tipo

element **Modulo_Familiari_Type/Familiari/Tipo**

diagram									
type	restriction of DatoAN_Type								
facets	<table border="0"> <tr> <td>Kind</td> <td>Value</td> </tr> <tr> <td>enumeration</td> <td>F</td> </tr> <tr> <td>enumeration</td> <td>D</td> </tr> <tr> <td>enumeration</td> <td>A</td> </tr> </table>	Kind	Value	enumeration	F	enumeration	D	enumeration	A
Kind	Value								
enumeration	F								
enumeration	D								
enumeration	A								

complexType **Modulo_Investimenti_Type**

diagram	
children	m730:Investimento

element **Modulo_Investimenti_Type/Investimento**

diagram

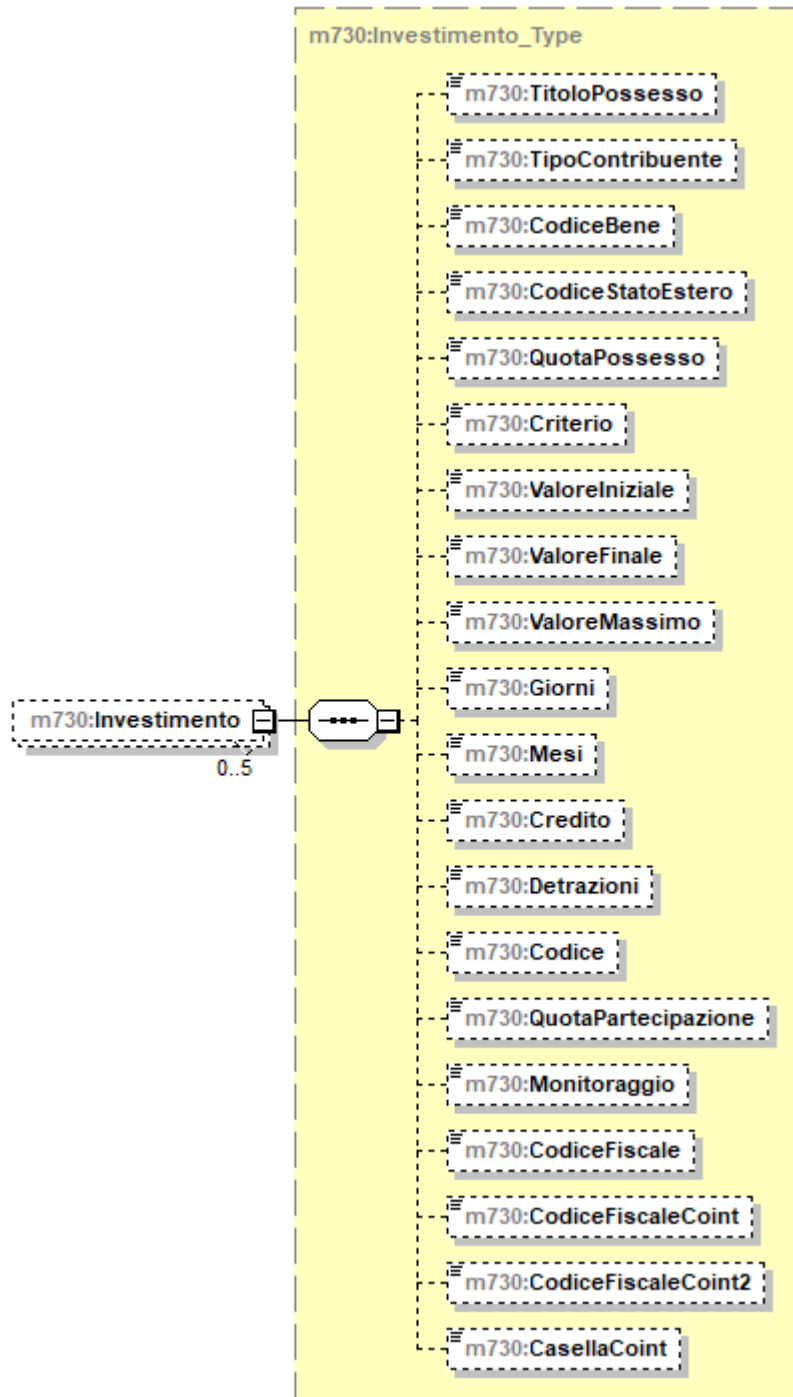

type [m730:Investimento_Type](#)

children [m730:TitoloPossesso](#) [m730:TipoContribuente](#) [m730:CodiceBene](#) [m730:CodiceStatoEstero](#) [m730:QuotaPossesso](#) [m730:Criterio](#) [m730:ValoreIniziale](#) [m730:ValoreFinale](#) [m730:ValoreMassimo](#) [m730:Giorni](#) [m730:Mesi](#) [m730:Credito](#) [m730:Detrazioni](#) [m730:Codice](#) [m730:QuotaPartecipazione](#) [m730:Monitoraggio](#) [m730:CodiceFiscale](#) [m730:CodiceFiscaleCoint](#) [m730:CodiceFiscaleCoint2](#) [m730:CasellaCoint](#)

complexType **Modulo_Lavoro_Dip_Type**

diagram	
children	m730:LavoroDipendente m730:PremiRisultato m730:AltriRedditiAssLavDip m730:Mance

element **Modulo_Lavoro_Dip_Type/LavoroDipendente**

diagram	
type	m730:Lavoro_Dipendente_Type
children	m730:TipologiaReddito m730:TipoContratto m730:Reddito m730:AltriRedditi

element **Modulo_Lavoro_Dip_Type/PremiRisultato**

diagram	
type	m730:Premi_Risultato_Modulo_Type

children	m730:TipoLimite m730:ImportoTassazOrdinaria m730:ImportoImpostaSostitutiva m730:RitenuteImpostaSostitutiva m730:Benefit m730:BenefitTassOrdinaria
----------	--

element **Modulo_Lavoro_Dip_Type/AltriRedditiAssLavDip**

diagram	
type	m730:Altri_Redditi_Ass_Lav_Type
children	m730:AssegnoDelConiuge m730:ImportoRedditoAssimilato m730:AltriDati

element **Modulo_Lavoro_Dip_Type/Mance**

diagram	
type	m730:Mance_Modulo_Type
children	m730:RedditoSettoreTuristico m730:ImportoTassazOrdinaria m730:ImportoImpostaSostitutiva m730:RitenuteImpostaSostitutiva

complexType **Modulo_Oneri_Type**

<p>diagram</p>	
<p>children</p>	<p>m730:SpeseDetrazioni m730:SpeseDeduzioni m730:InterventoRecuperoPatrimonioEdilizio m730:DatiCatastaliRecuperoPatrimonioEdilizio m730:InterventoRisparmioEnergetico m730:CanoniLocazione m730:DatiAltreDetrazioni m730:SpeseArredo m730:SpeseArredoGiovani m730:IvaAcquistoAbitazione m730:SpesePaceContrRicarica</p>

element **Modulo_Oneri_Type/SpeseDetrazioni**

<p>diagram</p>	
<p>type</p>	<p>m730:Detrazioni_Modulo_Type</p>
<p>children</p>	<p>m730:VeicoliDisabili m730:AcquistoCaniGuida m730:SpeseRateizzate m730:AltreSpese m730:SpeseLeasing</p>

element **Modulo_Oneri_Type/SpeseDeduzioni**

diagram	
type	m730:Deduzioni_Modulo_Type
children	m730:AssegnoConiuge m730:AltriOneri m730:AcquistoCostruzioneAbitLocazione

element **Modulo_Oneri_Type/InterventoRecuperoPatrimonioEdilizio**

diagram	
type	m730:Intervento_Recupero_Patrimonio_Edilizio_Type
children	m730:Anno m730:Periodo m730:CodiceFiscale m730:CasellaInterventiParticolari m730:CodiceSituazioniParticolari m730:MaggiorazioneSisma m730:Percentuale m730:Rate10 m730:Spesa m730:NOrdineImmobile

element **Modulo_Oneri_Type/DatiCatastaliRecuperoPatrimonioEdilizio**

diagram	
type	m730:Sezione Dati Catastali Recupero Patrimonio Edilizio Type
children	m730:DatiCatastaliRecuperoPatrimonioEdilizio m730:DatiRegistrazioneAccatastamentoRecuperoPatrimonio Edilizio

element **Modulo_Oneri_Type/InterventoRisparmioEnergetico**

diagram	
type	m730:Intervento Risparmio Energetico Type
children	m730:TipoIntervento m730:Anno m730:CasiParticolari m730:RideterminazioneRate m730:Percentuale m730:NumeroRata m730:Spesa m730:MaggiorazioneSisma

element **Modulo_Oneri_Type/CanoniLocazione**

diagram	
type	m730:Detrazioni Canoni Locazione Type

children	m730:InquiliniAbitazionePrincipale m730:DipendentiTrasferiti
----------	--

element **Modulo_Oneri_Type/DatiAltreDetrazioni**

diagram	
type	m730:Dati_Altre_Detrazioni_Modulo_Type
children	m730:AltreDetrazioni

element **Modulo_Oneri_Type/SpeseArredo**

diagram	
type	m730:Spese_Arredo_Type
children	m730:NumeroRata m730:Importo

element **Modulo_Oneri_Type/SpeseArredoGiovani**

diagram	
type	m730:Spese_Arredo_Giovani_Coppie_Type
children	m730:Meno35Anni m730:Importo

element **Modulo_Oneri_Type/IvaAcquistoAbitazione**

diagram	
type	m730:Iva_Acquisto_Abitazione_Type

children	m730:NumeroRata m730:Importo
----------	--

element **Modulo_Oneri_Type/SpesePaceContrRicarica**

diagram	
type	m730:Spese_Laurea_Ricarica_Type
children	m730:Codice m730:Anno m730:Importo m730:Percentuale m730:Rata

complexType **Modulo_PL_Type**

diagram	
children	m730:CredImpEstero

element **Modulo_PL_Type/CredImpEstero**

diagram	
type	m730:Cred_Imp_Estero_Type
children	m730:Anno m730:TotCredito m730:CreditoStato

complexType **Modulo_Terreno_Type**

diagram	
---------	--

children	m730:Terreno
----------	------------------------------

element **Modulo_Terreno_Type/Terreno**

diagram	
type	m730:Terreno_Type
children	m730:RedDominicale m730:Titolo m730:RedAgrario m730:GiorniPossesso m730:PercPossesso m730:CanoneVincolistico m730:CasiParticolari m730:CasellaContinuazione m730:CasellalmuNonDovuta m730:CasellaColtivatoreDiretto

complexType **Modulo_Ulteriori_Dati_Type**

diagram	
children	m730:RedditoCampione m730:RedditoCampioneFranchi m730:RivalutazioneTerreni m730:RedditiCapitaleSost

element **Modulo_Uteriori_Dati_Type/RedditoCampione**

diagram	
type	m730:Reddito_Campione_Type
children	m730:Codice m730:Importo

element **Modulo_Uteriori_Dati_Type/RedditoCampioneFranchi**

diagram	
type	m730:Reddito_Campione_Franchi_Type
children	m730:Codice m730:Importo

element **Modulo_Uteriori_Dati_Type/RivalutazioneTerreni**

diagram	
type	m730:Rivalutazione_Terreni_Type
children	m730:ValoreRivalutato m730:ImpostaDovuta m730:ImpostaVersata m730:ImpostaDaVersare m730:Rateizzazione m730:VersamentoCumulativo

element **Modulo_Ulteriori_Dati_Type/RedditiCapitaleSost**

<p>diagram</p>	
<p>type</p>	<p>m730:Redditi_Capitale_Sost_Type</p>
<p>children</p>	<p>m730:Tipo m730:Codice Stato Estero m730:Ammontare Reddito m730:Aliquota m730:Creditolva m730:Opzione Ordinaria m730:Proventi Particolari m730:Ecceденza Versamento</p>

complexType **Oneri_Non_Abbattuti_Type**

<p>diagram</p>	
<p>children</p>	<p>m730:Detraz Spese Ass Personale m730:Detraz Erogaz Biennale Venezia m730:Detraz Erogaz Spettacolo m730:Detraz Erogaz Settore Musicale m730:Deduz Contributi Paesi Sviluppo m730:Deduz Onlus m730:Detraz Ospedale Galliera m730:Interessi Mutui Agrari m730:Deduz Trust m730:Interessi Mutui Agrari 2022</p>

element **Oneri_Non_Abbattuti_Type/DetrazSpeseAssPersonale**

diagram	 m730:DetrazSpeseAssPersonale
type	DatoNP_Type

element **Oneri_Non_Abbattuti_Type/DetrazErogazBiennaleVenezia**

diagram	 m730:DetrazErogazBiennaleVen...
type	DatoNP_Type

element **Oneri_Non_Abbattuti_Type/DetrazErogazSpettacolo**

diagram	 m730:DetrazErogazSpettacolo
type	DatoNP_Type

element **Oneri_Non_Abbattuti_Type/DetrazErogazSettoreMusicale**

diagram	 m730:DetrazErogazSettoreMusi...
type	DatoNP_Type

element **Oneri_Non_Abbattuti_Type/DeduzContributiPaesiSviluppo**

diagram	 m730:DeduzContributiPaesiSvilu...
type	DatoNP_Type

element **Oneri_Non_Abbattuti_Type/DeduzOnlus**

diagram	 m730:DeduzOnlus
type	DatoNP_Type

element **Oneri_Non_Abbattuti_Type/DetrazOspedaleGalliera**

diagram	 m730:DetrazOspedaleGalliera
type	DatoNP_Type

element **Oneri_Non_Abbattuti_Type/InteressiMutuiAgrari**

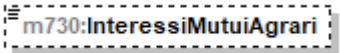
diagram	
type	DatoNP_Type

element **Oneri_Non_Abbattuti_Type/DeduzTrust**

diagram	
type	DatoNP_Type

element **Oneri_Non_Abbattuti_Type/InteressiMutuiAgrari2022**

diagram	
type	DatoNP_Type

complexType **Oneri_Type**

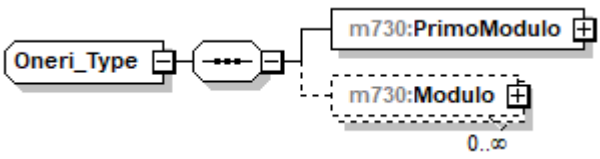
diagram	
children	m730:PrimoModulo m730:Modulo

element **Oneri_Type/PrimoModulo**

<p>diagram</p>	
<p>type</p>	<p>m730:Primo_Modulo_Oneri_Type</p>
<p>children</p>	<p> m730:SpeseDetrazioni m730:SpeseDeduzioni m730:InterventoRecuperoPatrimonioEdilizio m730:DatiCatastaliRecuperoPatrimonioEdilizio m730:InterventoRisparmioEnergetico m730:CanoniLocazione m730:DatiAltreDetrazioni m730:OneriNonAbbattuti m730:SpeseArredo m730:SpeseArredoGiovani m730:IvaAcquistoAbitazione m730:SpesePaceContrRicarica </p>

element **Oneri_Type/Modulo**

<p>diagram</p>	
<p>type</p>	<p>m730:Modulo_Oneri_Type</p>
<p>children</p>	<p>m730:SpeseDetrazioni m730:SpeseDeduzioni m730:InterventoRecuperoPatrimonioEdilizio m730:DatiCatastaliRecuperoPatrimonioEdilizio m730:InterventoRisparmioEnergetico m730:CanoniLocazione m730:DatiAltreDetrazioni m730:SpeseArredo m730:SpeseArredoGiovani m730:IvaAcquistoAbitazione m730:SpesePaceContrRicarica</p>

complexType **Opzione_Produttivita_Type**

<p>diagram</p>	
----------------	--

complexType **Periodo_Di_Lavoro_Type**

<p>diagram</p>	
<p>children</p>	<p>m730:GiorniLavoroDipendente m730:GiorniPensione</p>

element **Periodo_Di_Lavoro_Type/GiorniLavoroDipendente**

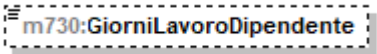
diagram	
type	DatoGA_Type

element **Periodo_Di_Lavoro_Type/GiorniPensione**

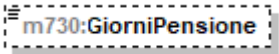
diagram	
type	DatoGA_Type

complexType **Pignoramento_Type**

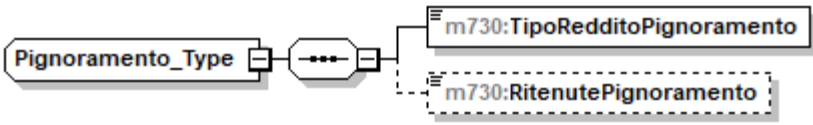
diagram	
children	m730:TipoRedditoPignoramento m730:RitenutePignoramento

element **Pignoramento_Type/TipoRedditoPignoramento**

diagram															
type	restriction of DatoN1_Type														
facets	<table border="1"> <thead> <tr> <th>Kind</th> <th>Value</th> </tr> </thead> <tbody> <tr> <td>enumeration</td> <td>1</td> </tr> <tr> <td>enumeration</td> <td>2</td> </tr> <tr> <td>enumeration</td> <td>3</td> </tr> <tr> <td>enumeration</td> <td>4</td> </tr> <tr> <td>enumeration</td> <td>5</td> </tr> <tr> <td>enumeration</td> <td>6</td> </tr> </tbody> </table>	Kind	Value	enumeration	1	enumeration	2	enumeration	3	enumeration	4	enumeration	5	enumeration	6
Kind	Value														
enumeration	1														
enumeration	2														
enumeration	3														
enumeration	4														
enumeration	5														
enumeration	6														

element **Pignoramento_Type/RitenutePignoramento**

diagram	
type	DatoNP_Type

complexType Premi_Risultato_Modulo_Type

diagram	
children	m730:TipoLimite m730:ImportoTassazOrdinaria m730:ImportoImpostaSostitutiva m730:RitenuteImpostaSostitutiva m730:Benefit m730:BenefitTassOrdinaria

element Premi_Risultato_Modulo_Type/TipoLimite

diagram							
type	restriction of DatoN1_Type						
facets	<table border="1"> <thead> <tr> <th>Kind</th> <th>Value</th> </tr> </thead> <tbody> <tr> <td>enumeration</td> <td>1</td> </tr> <tr> <td>enumeration</td> <td>2</td> </tr> </tbody> </table>	Kind	Value	enumeration	1	enumeration	2
Kind	Value						
enumeration	1						
enumeration	2						

element Premi_Risultato_Modulo_Type/ImportoTassazOrdinaria

diagram	
type	DatoNP_Type

element Premi_Risultato_Modulo_Type/ImportoImpostaSostitutiva

diagram	
type	DatoNP_Type

element Premi_Risultato_Modulo_Type/RitenuteImpostaSostitutiva

diagram	
type	DatoNP_Type

element **Premi_Risultato_Modulo_Type/Benefit**

diagram	
type	DatoNP_Type

element **Premi_Risultato_Modulo_Type/BenefitTassOrdinaria**

diagram	
type	DatoNP_Type

complexType **Premi_Risultato_Type**

diagram	
type	extension of m730:Premi_Risultato_Modulo_Type
children	m730:TipoLimite m730:ImportoTassazOrdinaria m730:ImportoImpostaSostitutiva m730:RitenuteImpostaSostitutiva m730:Benefit m730:BenefitTassOrdinaria m730:TassazOrdinaria m730:TassazSostitutiva m730:AssenzaRequisiti

element **Premi_Risultato_Type/TassazOrdinaria**

diagram	
type	DatoCB_Type

element **Premi_Risultato_Type/TassazSostitutiva**

diagram	
type	DatoCB_Type

element **Premi_Risultato_Type/AssenzaRequisiti**

diagram	
type	DatoCB_Type

complexType **Primo_Modulo_Acconti_Ritenute_Type**

diagram	
children	m730:Accontilrpef m730:AltreRitenute m730:Eccedenze m730:EccedenzeOltreAnno m730:RitenuteAccontiSospesi m730:MisuraAcconti m730:EsenzioneAddComunale m730:Dati730Integrativo m730:AccontiAltriDati m730:LocazioniBrevi

element **Primo Modulo Acconti Ritenute Type/Accontilrpef**

diagram	
type	m730:Acconti_Irpef_Anno_Imposta_Type
children	m730:PrimaRataAccontolrpef m730:SecondaRataAccontolrpef m730:AccontoAddComunale m730:PrimaRataAccontoCedolare m730:SecondaRataAccontoCedolare

element **Primo Modulo Acconti Ritenute Type/AltreRitenute**

diagram	
type	m730:Altre_Ritenute_Type
children	m730:Codice m730:AltreRitenuteIrpef m730:AddizionaleRegionale m730:AddizionaleComunale m730:AddRegionaleIrpefAttivitaSport m730:AddComunaleIrpefAttivitaSport m730:IrpefLavoriSocialmenteUtili m730:AddRegionaleIrpefLavoriSoc Utili

element **Primo Modulo Acconti Ritenute Type/Eccedenze**

<p>diagram</p>	
<p>type</p>	<p>m730:Eccedenze_Type</p>
<p>children</p>	<p>m730:Irpef m730:IrpefCompF24 m730:SostitutivaQuadroRT m730:SostitutivaQuadroRTcompF24 m730:CedolareSecca m730:CedolareSeccaCompF24 m730:CodiceRegione m730:AddRegionaleIrpef m730:AddRegionaleIrpefCompF24 m730:CodiceCatastaleComune m730:AddComunaleIrpef m730:AddComunaleIrpefF24 m730:PremioRisultato m730:PremioRisultatoCompF24</p>

element **Primo_Modulo_Acconti_Ritenute_Type/EccedenzeOltreAnno**

<p>diagram</p>	
<p>type</p>	<p>m730:Eccedenze Oltre Anno Type</p>
<p>children</p>	<p>m730:Anno m730:Irpef m730:SostitutivaQuadroRT m730:CedolareSecca m730:CodiceRegione m730:AddRegionaleIrpef m730:CodiceCatastaleComune m730:AddComunaleIrpef m730:ImpostaSostitutiva</p>

element **Primo_Modulo_Acconti_Ritenute_Type/RitenuteAccontiSospesi**

<p>diagram</p>	
<p>type</p>	<p>m730:Ritenute Acconti Sospesi Type</p>
<p>children</p>	<p>m730:CodiceEvento m730:Irpef m730:AddRegionaleIrpef m730:AddComunaleIrpef m730:SostitutivaPremi m730:CedolareSecca m730:SostitutivaRita</p>

element **Primo_Modulo_Acconti_Ritenute_Type/MisuraAcconti**

diagram	
type	m730:Misura_Acconti_Type
children	m730:lrpefMisuralInferiore m730:AddComunaleMisuralInferiore m730:CedolareSeccaMisuralInferiore m730:NumeroRate m730:CriptoAttMisuralInferiore m730:lvieMisuralInferiore m730:lvafeMisuralInferiore

element **Primo_Modulo_Acconti_Ritenute_Type/EsenzioneAddComunale**

diagram	
type	m730:Esenzione_Add_Comunale_Type
children	m730:SogliaEsenzioneSaldo m730:SogliaEsenzioneAcconto

element **Primo_Modulo_Acconti_Ritenute_Type/Dati730Integrativo**

diagram	
type	m730:Dati_730_Integrativo_Type
children	m730:Rimborso m730:Credito

element **Primo_Modulo_Acconti_Ritenute_Type/AccontiAltriDati**

diagram	
type	m730:Acconti_Altri_Dati_Type
children	m730:IncapientiDetrazioneLocazione m730:Pignoramento ; EccedenzaVersSaldoMance

element **Primo_Modulo_Acconti_Ritenute_Type/LocazioniBrevi**

diagram	
type	m730:Locazioni_Brevi_Type
children	m730:Ritenute

complexType **Primo_Modulo_Crediti_Imposta_Type**

diagram	
children	m730:CreditoImpostaFabbricati m730:CreditoImpostaFondiPensione m730:CreditoImpostaRedditiEsteri m730:CreditoPrimaCasaSismaAbruzzo m730:CreditoAltriSismaAbruzzo m730:CreditoPrimaCasaU36 m730:CreditoErogazioniCultura m730:AltriCreditoImposta

element **Primo Modulo_Crediti_Imposta_Type/CreditiImpostaFabbricati**

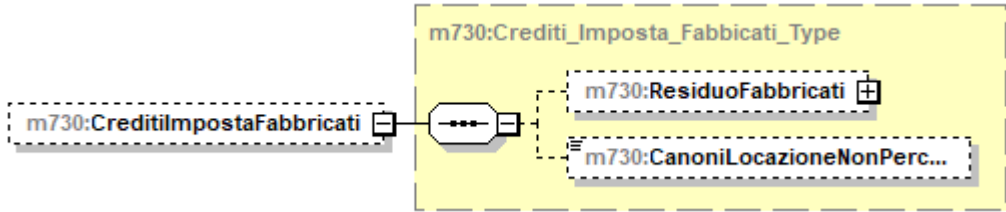
diagram	
type	m730:Crediti_Imposta_Fabbricati_Type
children	m730:ResiduoFabbricati m730:CanoniLocazioneNonPercepiti

element **Primo Modulo_Crediti_Imposta_Type/CreditiImpostaFondiPensione**

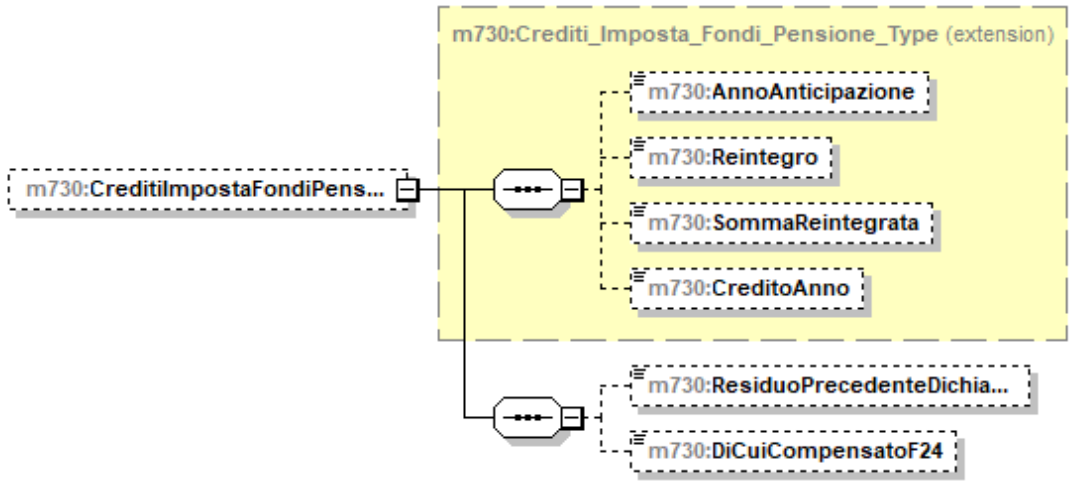
diagram	
type	extension of m730:Crediti_Imposta_Fondi_Pensione_Type
children	m730:AnnoAnticipazione m730:Reintegro m730:SommaReintegrata m730:CreditoAnno m730:ResiduoPrecedenteDichiarazione m730:DiCuiCompensatoF24

element **Primo Modulo_Crediti_Imposta_Type/CreditiImpostaFondiPensione/ResiduoPrecedenteDichiarazione**

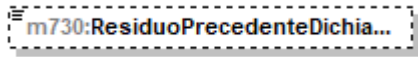
diagram	
type	DatoNP_Type

element **Primo Modulo_Crediti_Imposta_Type/CreditiImpostaFondiPensione/DiCuiCompensatoF24**

diagram	
type	DatoNP_Type

element **Primo_Modulo_Crediti_Imposta_Type/CreditiImpostaRedditiEsteri**

diagram	
type	m730:Crediti_Imposta_Redditi_Esteri_Type
children	m730:StatoEstero m730:Anno m730:RedditoEstero m730:ImpostaEstera m730:RedditoComplessivo m730:Imposta_Lorda m730:ImpostaNetta m730:CreditoDichiarazioniPrecedenti m730:DiCuiStatoEstero

element **Primo_Modulo_Crediti_Imposta_Type/CreditoPrimaCasaSismaAbruzzo**

diagram	
type	extension of m730:Credito_Immibile_Sisma_Abruzzo_Type
children	m730:CodiceFiscale m730:NumeroRata m730:TotaleCredito m730:ResiduoPrecedenteDichiarazione

element **Primo_Modulo_Crediti_Imposta_Type/CreditoPrimaCasaSismaAbruzzo/ResiduoPrecedenteDichiarazione**

diagram	
---------	--

type	DatoNP Type
------	-----------------------------

element **Primo_Modulo_Crediti_Imposta_Type/CreditoAltriSismaAbruzzo**

diagram	
type	m730:Crediti_Imposta_Altri_Sisma_Abruzzo_Type
children	m730:Impresa_Professione m730:CodiceFiscale m730:NumeroRata m730:TotaleCredito m730:Rateazione

element **Primo_Modulo_Crediti_Imposta_Type/CreditoPrimaCasaU36**

diagram	
type	m730:Credito_Prima_Casa_U36
children	m730:ResiduoAnnoPrec m730:SpesaAnno m730:DiCuiCompensatoF24 m730:DiCuiCompensatoAtto

element **Primo_Modulo_Crediti_Imposta_Type/CreditoErogazioniCultura**

diagram	
type	m730:Credito_Erogazioni_Cultura_Type
children	m730:SpesaAnno m730:ResiduoAnnoPrec m730:RataAnnoPrec m730:RataDueAnniPrec

element **Primo_Modulo_Crediti_Imposta_Type/AltriCreditiImposta**

diagram	
type	m730:Altri_Crediti_Imposta_Type
children	m730:Codice m730:Importo m730:ResiduoAnnoPrec m730:RataDueAnniPrec m730:DiCuiCompensatoF24

complexType **Primo_Modulo_Familiari_Type**

diagram	
type	extension of m730:Modulo_Familiari_Type

children	m730:Coniuge m730:PrimoFiglio m730:Familiari m730:FigliAffidoPread
----------	--

element **Primo_Modulo_Familiari_Type/FigliAffidoPread**

diagram	
type	DatoNP_Type

complexType **Primo_Modulo_Investimenti_Type**

diagram	
type	extension of m730:Modulo_Investimenti_Type
children	m730:Investimento m730:Eccedenzelvafe m730:Eccedenzelvie m730:EccedenzeCripto

element **Primo_Modulo_Investimenti_Type/Eccedenzelvafe**

diagram	
type	m730:Eccedenze_Estero_Type
children	m730:EccedenzaPrecDic m730:EccedenzaCompensata m730:AccontiVersati m730:EccedenzaVersamento

element **Primo_Modulo_Investimenti_Type/Eccedenzelvie**

diagram	<pre> classDiagram class m730Eccedenzelvie class m730Eccedenze_Estero_Type { m730EccedenzaPrecDic m730EccedenzaCompensata m730AccontiVersati m730EccedenzaVersamento } m730Eccedenzelvie -- m730Eccedenze_Estero_Type </pre>
type	m730:Eccedenze_Estero_Type
children	m730:EccedenzaPrecDic m730:EccedenzaCompensata m730:AccontiVersati m730:EccedenzaVersamento

element **Primo_Modulo_Investimenti_Type/EccedenzeCripto**

diagram	<pre> classDiagram class m730EccedenzeCripto class m730EccedenzaVersamento m730EccedenzeCripto -- m730EccedenzaVersamento </pre>
children	m730:EccedenzaVersamento

element **Primo_Modulo_Investimenti_Type/EccedenzeCripto/EccedenzaVersamento**

diagram	<pre> classDiagram class m730EccedenzaVersamento </pre>
type	DatoNP_Type

complexType **Primo_Modulo_Lavoro_Dip_Type**

<p>diagram</p>	
<p>children</p>	<p>m730:LavoroDipendente m730:PremiRisultato m730:PeriodoLavoro m730:AltriRedditiAssLavDip m730:RitenuteLavoroDipendente m730:RiduzionePressioneFiscale m730:CasellaCasiParticolari m730:StatoEstero m730:CompartoSicurezza m730:Mance</p>

element **Primo_Modulo_Lavoro_Dip_Type/LavoroDipendente**

<p>diagram</p>	
<p>type</p>	<p>m730:Lavoro_Dipendente_Type</p>
<p>children</p>	<p>m730:TipologiaReddito m730:TipoContratto m730:Reddito m730:AltriRedditi</p>

element **Primo Modulo Lavoro Dip Type/PremiRisultato**

<p>diagram</p>	
<p>type</p>	<p>m730:Premi_Risultato_Type</p>
<p>children</p>	<p>m730:TipoLimite m730:ImportoTassazOrdinaria m730:ImportoImpostaSostitutiva m730:RitenuteImpostaSostitutiva m730:Benefit m730:BenefitTassOrdinaria m730:TassazOrdinaria m730:TassazSostitutiva m730:AssenzaRequisiti</p>

element **Primo Modulo Lavoro Dip Type/PeriodoLavoro**

<p>diagram</p>	
<p>type</p>	<p>m730:Periodo_Di_Lavoro_Type</p>
<p>children</p>	<p>m730:GiorniLavoroDipendente m730:GiorniPensione</p>

element **Primo Modulo Lavoro Dip Type/AltriRedditiAssLavDip**

<p>diagram</p>	
----------------	--

type	m730:Altri Redditi Ass Lav Type
children	m730:AssegnoDelConiuge m730:ImportoRedditoAssimilato m730:AltriDati

element **Primo_Modulo_Lavoro_Dip_Type/RitenuteLavoroDipendente**

diagram	
type	m730:Ritenute Lavoro Dip Type
children	m730:Ritlrpef m730:RitRita m730:RitAddRegionale m730:RitAccAddComunale m730:RitSaldoAddComunale m730:RitAccAddComAnnoPres

element **Primo_Modulo_Lavoro_Dip_Type/RiduzionePressioneFiscale**

diagram	
type	m730:Riduzione Pressione Type
children	m730:CodiceTrattamento m730:TrattamentoErogato m730:EsenzioneRicercatori m730:EsenzioneImpatriati

element **Primo_Modulo_Lavoro_Dip_Type/CasellaCasiParticolari**

diagram							
type	restriction of DatoNP_Type						
facets	<table border="1"> <thead> <tr> <th>Kind</th> <th>Value</th> </tr> </thead> <tbody> <tr> <td>enumeration</td> <td>2</td> </tr> <tr> <td>enumeration</td> <td>4</td> </tr> </tbody> </table>	Kind	Value	enumeration	2	enumeration	4
Kind	Value						
enumeration	2						
enumeration	4						

enumeration	6
enumeration	8
enumeration	9
enumeration	10
enumeration	11
enumeration	12
enumeration	13
enumeration	14
enumeration	15

element **Primo Modulo Lavoro Dip_Type/StatoEstero**

diagram	
type	DatoAN_Type

element **Primo Modulo Lavoro Dip_Type/CompartoSicurezza**

diagram	
type	m730:Comparto_Sicurezza_Type
children	m730:FruitaOrdinaria m730:NonFruitaOrdinaria m730:FruitaSeparata

element **Primo Modulo Lavoro Dip_Type/Mance**

diagram	
type	m730:Mance_Type

children	m730:RedditoSettoreTuristico m730:ImportoTassazOrdinaria m730:ImportoImpostaSostitutiva m730:RitenuteImpostaSostitutiva m730:TassazOrdinaria m730:TassazSostitutiva m730:AssenzaRequisiti
----------	--

complexType **Primo_Modulo_Oneri_Type**

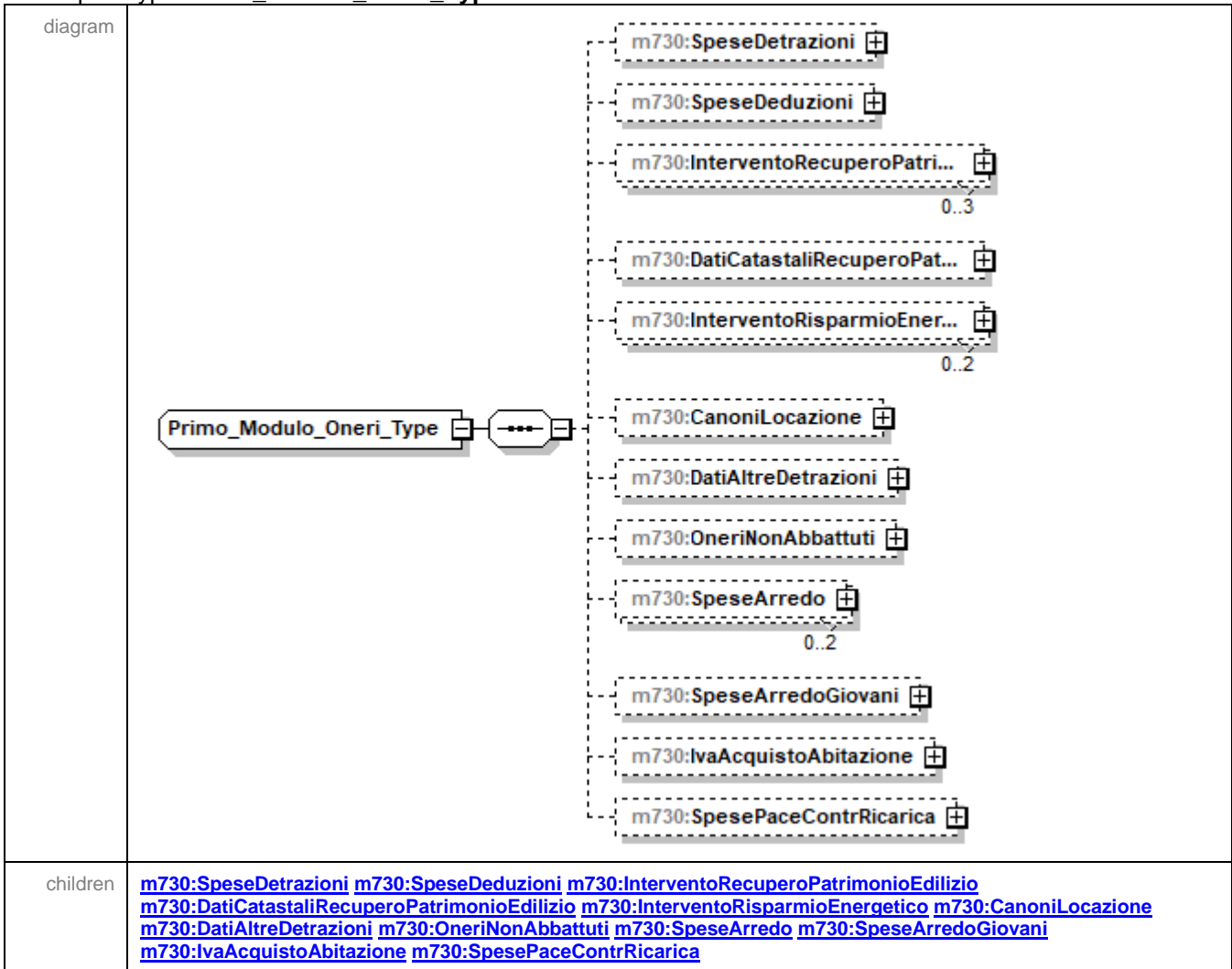

element **Primo_Modulo_Oneri_Type/SpeseDetrazioni**

<p>diagram</p>	
<p>type</p>	<p>m730:Detrazioni_Type</p>
<p>children</p>	<p>m730:CasellaRateazione m730:SpeseDeterminatePatologie m730:SpeseSanitarie m730:SpeseFamNonACarico m730:SpeseSanitarieDisabili m730:VeicoliDisabili m730:AcquistoCaniGuida m730:SpeseRateizzate m730:MutuiAbPrincipaleAnte m730:MutuiAbPrincipalePost m730:Altre Spese m730:SpeseLeasing</p>

element **Primo Modulo Oneri Type/SpeseDeduzioni**

<p>diagram</p>	<pre> classDiagram class m730Deduzioni_Type { m730ContributiPrevAss m730AssegnoConiuge m730ContributiColf m730ErogazioniIstituzioniReligi... m730SpesePortatoriHandicap m730AltriOneri m730DeducibilitaOrdinaria m730LavoratoriPrimaOccupazi... m730FondiInSquilibrioFinanzia... m730FamiliariACarico m730AcquistoCostruzioneAbit... m730RestituzioneSomme m730ErogazioniOnlus } class m730SpeseDeduzioni m730SpeseDeduzioni .. m730Deduzioni_Type </pre>
<p>type</p>	<p>m730:Deduzioni_Type</p>
<p>children</p>	<p> m730:ContributiPrevAss m730:AssegnoConiuge m730:ContributiColf m730:ErogazioniIstituzioniReligiose m730:SpesePortatoriHandicap m730:AltriOneri m730:DeducibilitaOrdinaria m730:LavoratoriPrimaOccupazione m730:FondiInSquilibrioFinanziario m730:FamiliariACarico m730:AcquistoCostruzioneAbitLocazione m730:RestituzioneSomme m730:ErogazioniOnlus </p>

element **Primo_Modulo_Oneri_Type/InterventoRecuperoPatrimonioEdilizio**

diagram	
type	m730:Intervento_Ricupero_Patrimonio_Edilizio_Type
children	m730:Anno m730:Periodo m730:CodiceFiscale m730:CasellaInterventiParticolari m730:CodiceSituazioniParticolari m730:MaggiorazioneSisma m730:Percentuale m730:Rate10 m730:Spesa m730:NOrdineImmobile

element **Primo_Modulo_Oneri_Type/DatiCatastaliRecuperoPatrimonioEdilizio**

diagram	
type	m730:Sezione Dati Catastali Ricupero Patrimonio Edilizio_Type
children	m730:DatiCatastaliRecuperoPatrimonioEdilizio m730:DatiRegistrazioneAccatastamentoRecuperoPatrimonio Edilizio

element **Primo Modulo Oneri Type/InterventoRisparmioEnergético**

<p>diagram</p>	
<p>type</p>	<p>m730:Intervento Risparmio Energetico Type</p>
<p>children</p>	<p>m730:TipoIntervento m730:Anno m730:CasiParticolari m730:RideterminazioneRate m730:Percentuale m730:NumeroRata m730:Spesa m730:MaggiorazioneSisma</p>

element **Primo Modulo Oneri Type/CanoniLocazione**

<p>diagram</p>	
<p>type</p>	<p>m730:Detrazioni Canoni Locazione Type</p>
<p>children</p>	<p>m730:InquiliniAbitazionePrincipale m730:DipendentiTrasferiti</p>

element **Primo Modulo Oneri Type/DatiAltreDetrazioni**

<p>diagram</p>	
<p>type</p>	<p>m730:Dati Altre Detrazioni Type</p>
<p>children</p>	<p>m730:SpeseCaniGuida m730:AltreDetrazioni</p>

element **Primo_Modulo_Oneri_Type/OneriNonAbbattuti**

diagram	
type	m730:Oneri Non Abbattuti Type
children	m730:DetrazSpeseAssPersonale m730:DetrazErogazBiennaleVenezia m730:DetrazErogazSpettacolo m730:DetrazErogazSettoreMusicale m730:DeduzContributiPaesiSviluppo m730:DeduzOnlus m730:DetrazOspedaleGalliera m730:InteressiMutuiAgrari m730:DeduzTrust m730:InteressiMutuiAgrari2022

element **Primo_Modulo_Oneri_Type/SpeseArredo**

diagram	
type	m730:Spese Arredo Type
children	m730:NumeroRata m730:Importo

element **Primo_Modulo_Oneri_Type/SpeseArredoGiovani**

diagram	
type	m730:Spese_Arredo_Giovani_Coppie_Type
children	m730:Meno35Anni m730:Importo

element **Primo_Modulo_Oneri_Type/IvaAcquistoAbitazione**

diagram	
type	m730:Iva_Acquisto_Abitazione_Type
children	m730:NumeroRata m730:Importo

element **Primo_Modulo_Oneri_Type/SpesePaceContrRicarica**

diagram	
type	m730:Spese_Laurea_Ricarica_Type
children	m730:Codice m730:Anno m730:Importo m730:Percentuale m730:Rata

complexType **Primo_Modulo_PL_Type**

diagram	
---------	--

children	m730:Prospetto m730:ProspettoRideterminato
----------	--

element **Primo_Modulo_PL_Type/Prospetto**

diagram	
type	extension of m730:Prospetto_Type
children	m730:RiepilogoRedditi m730:ImpostaLorda m730:DetrazioniCrediti m730:ImpostaNetta m730:Addizionali m730:CedolareSecca m730:LiquidazioneImposte m730:AltriDati m730:CredImpEstero m730:DatiCreditiF24 m730:LiquidazioneImposteSost

element **Primo_Modulo_PL_Type/Prospetto/Addizionali**

diagram	
type	m730:Addizionali_Type
children	m730:Imponibile m730:AddRegDovuta m730:AddRegCertif m730:EccedenzaAddReg m730:AddComDovuta m730:AddComCertif m730:EccedenzaAddCom m730:AccontoAddCom m730:AccontoAddComCertif

element **Primo_Modulo_PL_Type/Prospetto/CedolareSecca**

diagram	
type	m730:Cedolare_Secca_Type
children	m730:CedolareDovuta m730:CedolareDifferenza m730:EccedenzaCedolareSecca m730:AccontoCedolare

element **Primo_Modulo_PL_Type/Prospetto/LiquidazioneImposte**

<p>diagram</p>	
<p>children</p>	<p>m730:EsitoIrpef m730:EsitoAddRegionale m730:EsitoAddComunale m730:PrimaRataAcclrpef m730:SecondaRataAcclrpef m730:AccontoTassSep m730:AccontoAddComunale m730:ImpostaSostitutiva m730:EsitoCedolareSecca m730:PrimaRataAccCedolare m730:SecondaRataAccCedolare</p>

element **Primo_Modulo_PL_Type/Prospetto/LiquidazioneImposte/EsitoIrpef**

<p>diagram</p>	
<p>type</p>	<p>m730:Esito_Liquidazione_Type</p>
<p>children</p>	<p>m730:Credito m730:Debito</p>

element **Primo_Modulo_PL_Type/Prospetto/LiquidazioneImposte/EsitoAddRegionale**

diagram	
type	extension of m730:Esito Liquidazione Type
children	m730:Credito m730:Debito m730:CodAddReg

element **Primo_Modulo_PL_Type/Prospetto/LiquidazioneImposte/EsitoAddRegionale/CodAddReg**

diagram																																													
type	Codice Regione Type																																												
facets	<table border="1"> <thead> <tr> <th>Kind</th> <th>Value</th> </tr> </thead> <tbody> <tr><td>enumeration</td><td>1</td></tr> <tr><td>enumeration</td><td>2</td></tr> <tr><td>enumeration</td><td>3</td></tr> <tr><td>enumeration</td><td>4</td></tr> <tr><td>enumeration</td><td>5</td></tr> <tr><td>enumeration</td><td>6</td></tr> <tr><td>enumeration</td><td>7</td></tr> <tr><td>enumeration</td><td>8</td></tr> <tr><td>enumeration</td><td>9</td></tr> <tr><td>enumeration</td><td>10</td></tr> <tr><td>enumeration</td><td>11</td></tr> <tr><td>enumeration</td><td>12</td></tr> <tr><td>enumeration</td><td>13</td></tr> <tr><td>enumeration</td><td>14</td></tr> <tr><td>enumeration</td><td>15</td></tr> <tr><td>enumeration</td><td>16</td></tr> <tr><td>enumeration</td><td>17</td></tr> <tr><td>enumeration</td><td>18</td></tr> <tr><td>enumeration</td><td>19</td></tr> <tr><td>enumeration</td><td>20</td></tr> <tr><td>enumeration</td><td>21</td></tr> </tbody> </table>	Kind	Value	enumeration	1	enumeration	2	enumeration	3	enumeration	4	enumeration	5	enumeration	6	enumeration	7	enumeration	8	enumeration	9	enumeration	10	enumeration	11	enumeration	12	enumeration	13	enumeration	14	enumeration	15	enumeration	16	enumeration	17	enumeration	18	enumeration	19	enumeration	20	enumeration	21
Kind	Value																																												
enumeration	1																																												
enumeration	2																																												
enumeration	3																																												
enumeration	4																																												
enumeration	5																																												
enumeration	6																																												
enumeration	7																																												
enumeration	8																																												
enumeration	9																																												
enumeration	10																																												
enumeration	11																																												
enumeration	12																																												
enumeration	13																																												
enumeration	14																																												
enumeration	15																																												
enumeration	16																																												
enumeration	17																																												
enumeration	18																																												
enumeration	19																																												
enumeration	20																																												
enumeration	21																																												

element **Primo_Modulo_PL_Type/Prospetto/LiquidazioneImposte/EsitoAddComunale**

diagram	
type	extension of m730:Esito Liquidazione Type

children	m730:Credito m730:Debito m730:CodiceAddCom
----------	--

element **Primo_Modulo_PL_Type/Prospetto/LiquidazioneImposte/EsitoAddComunale/CodiceAddCom**

diagram	
type	DatoAN_Type

element **Primo_Modulo_PL_Type/Prospetto/LiquidazioneImposte/PrimaRataAcclrpef**

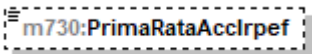
diagram	
type	DatoNP_Type

element **Primo_Modulo_PL_Type/Prospetto/LiquidazioneImposte/SecondaRataAcclrpef**

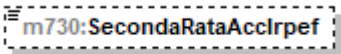
diagram	
type	DatoNP_Type

element **Primo_Modulo_PL_Type/Prospetto/LiquidazioneImposte/AccontoTassSep**

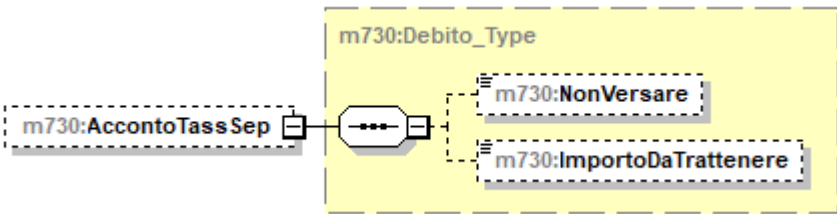
diagram	
type	m730:Debito_Type
children	m730:NonVersare m730:ImportoDaTrattenere

element **Primo_Modulo_PL_Type/Prospetto/LiquidazioneImposte/AccontoAddComunale**

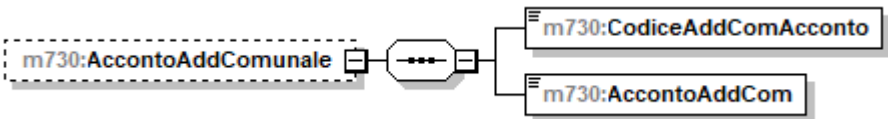
diagram	
children	m730:CodiceAddComAcconto m730:AccontoAddCom

element

Primo_Modulo_PL_Type/Prospetto/LiquidazioneImposte/AcontoAddComunale/CodiceAddComAcconto

diagram	
type	DatoAN_Type

element

Primo_Modulo_PL_Type/Prospetto/LiquidazioneImposte/AcontoAddComunale/AcontoAddCom

diagram	
type	DatoNP_Type

element **Primo_Modulo_PL_Type/Prospetto/LiquidazioneImposte/ImpostaSostitutiva**

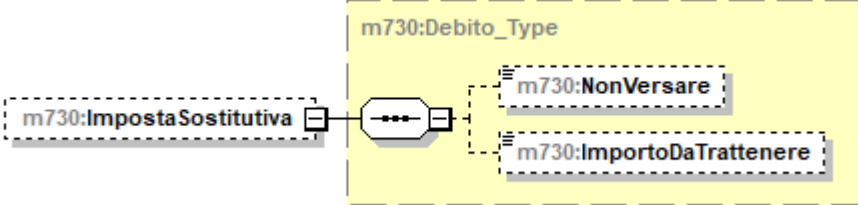
diagram	
type	m730:Debito_Type
children	m730:NonVersare m730:ImportoDaTrattenere

element **Primo_Modulo_PL_Type/Prospetto/LiquidazioneImposte/EsitoCedolareSecca**

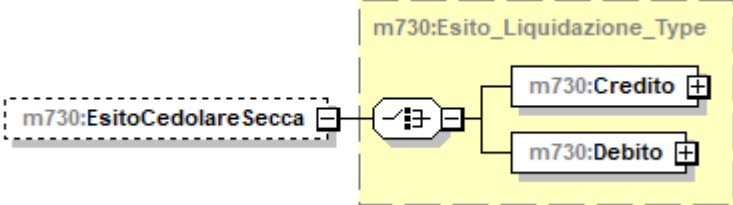
diagram	
type	m730:Esito_Liquidazione_Type
children	m730:Credito m730:Debito

element **Primo_Modulo_PL_Type/Prospetto/LiquidazioneImposte/PrimaRataAccCedolare**

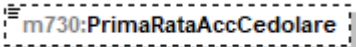
diagram	
type	DatoNP_Type

element **Primo_Modulo_PL_Type/Prospetto/LiquidazioneImposte/SecondaRataAccCedolare**

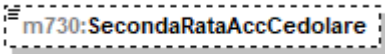
diagram	
type	DatoNP_Type

element **Primo_Modulo_PL_Type/Prospetto/AltriDati**

diagram

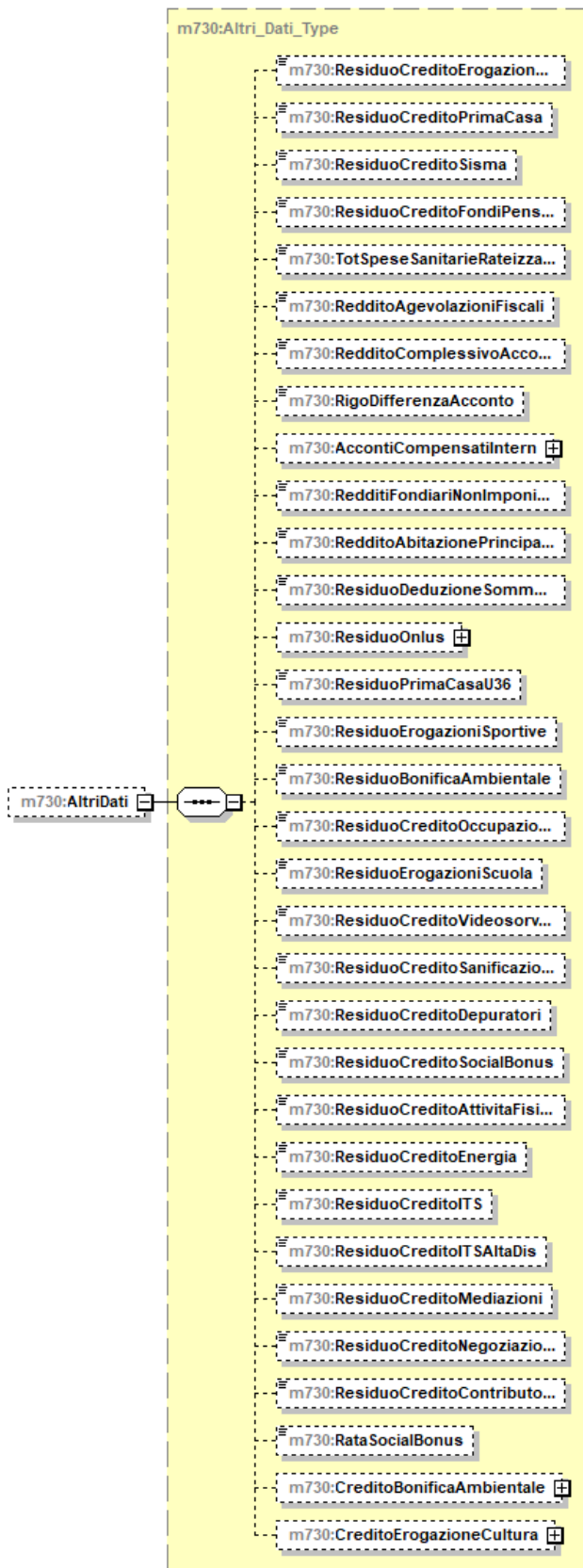

type	m730:Altri Dati Type
children	m730:ResiduoCreditoErogazioneCultura m730:ResiduoCreditoPrimaCasa m730:ResiduoCreditoSisma m730:ResiduoCreditoFondiPensione m730:TotSpeseSanitarieRateizzate m730:RedditoAgevolazioniFiscali m730:RedditoComplessivoAcconto m730:RigoDifferenzaAcconto m730:AccontiCompensatiIntern m730:RedditiFondariNonImponibili m730:RedditoAbitazionePrincipalePertinenze m730:ResiduoDeduzioneSommeRestituite m730:ResiduoOnlus m730:ResiduoPrimaCasaU36 m730:ResiduoErogazioniSportive m730:ResiduoBonificaAmbientale m730:ResiduoCreditoOccupazione m730:ResiduoErogazioniScuola m730:ResiduoCreditoVideosorveglianza m730:ResiduoCreditoSanificazione m730:ResiduoCreditoDepuratori m730:ResiduoCreditoSocialBonus m730:ResiduoCreditoAttivitaFisica m730:ResiduoCreditoEnergia m730:ResiduoCreditoITS m730:ResiduoCreditoITSAltaDis m730:ResiduoCreditoMediazioni m730:ResiduoCreditoNegoziazione m730:ResiduoCreditoContributoUnif m730:RataSocialBonus m730:CreditoBonificaAmbientale m730:CreditoErogazioneCultura

element **Primo_Modulo_PL_Type/Prospetto/CredImpEstero**

diagram	<pre> classDiagram class m730CredImpEstero { } class m730Cred_Imp_Estero_Type { m730Anno m730TotCredito m730CreditoStato 1..2 } m730CredImpEstero .. > m730Cred_Imp_Estero_Type </pre>
type	m730:Cred Imp Estero Type
children	m730:Anno m730:TotCredito m730:CreditoStato

element **Primo_Modulo_PL_Type/Prospetto/DatiCreditiF24**

<p>diagram</p>	
<p>type</p>	<p>m730:Crediti_F24_Type</p>
<p>children</p>	<p>m730:Credlrpef m730:CredlrpefDipNoSostituto m730:CodAddReg m730:CredAddReg m730:CredAddRegDipNoSostituto m730:CodiceAddCom m730:CredAddCom m730:CredAddComDipNoSostituto m730:CredCedolare m730:CredCedolareDipNoSostituto m730:CredTassSeparDipNoSostituto m730:CredImpostaSostDipNoSostituto m730:DatiF24Cripto m730:DatiF24lvie m730:DatiF24lvafe m730:DatiF24FonteEstera m730:DatiF24Mance m730:TotaleCredito m730:TotaleDipNoSostituto m730:TotaleDebito</p>

element **Primo_Modulo_PL_Type/Prospetto/LiquidazioneImposteSost**

<p>diagram</p>	
<p>children</p>	<p>m730:EsitoCripto m730:PrimaRataAccCripto m730:SecondaRataAccCripto m730:Esitolvie m730:PrimaRataAcclvie m730:SecondaRataAcclvie m730:Esitolvafe m730:PrimaRataAcclvafe m730:SecondaRataAcclvafe m730:EsitoCapitaleFonteEstera m730:EsitoMance</p>

element **Primo_Modulo_PL_Type/Prospetto/LiquidazioneImposteSost/EsitoCripto**

<p>diagram</p>	
<p>children</p>	<p>m730:ImpostaDovuta m730:ImpostaDebito m730:EccedenzaVers m730:CreditoComp m730:Rimborso</p>

element **Primo_Modulo_PL_Type/Prospetto/LiquidazioneImposteSost/EsitoCripto/ImpostaDovuta**

<p>diagram</p>	
<p>type</p>	<p>DatoNP_Type</p>

element **Primo_Modulo_PL_Type/Prospetto/LiquidazioneImposteSost/EsitoCripto/ImpostaDebito**

diagram	
type	DatoNP_Type

element **Primo_Modulo_PL_Type/Prospetto/LiquidazioneImposteSost/EsitoCripto/EccedenzaVers**

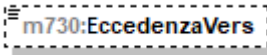
diagram	
type	DatoNP_Type

element **Primo_Modulo_PL_Type/Prospetto/LiquidazioneImposteSost/EsitoCripto/CreditoComp**

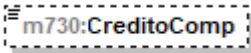
diagram	
type	DatoNP_Type

element **Primo_Modulo_PL_Type/Prospetto/LiquidazioneImposteSost/EsitoCripto/Rimborso**

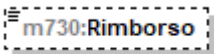
diagram	
type	DatoNP_Type

element **Primo_Modulo_PL_Type/Prospetto/LiquidazioneImposteSost/PrimaRataAccCripto**

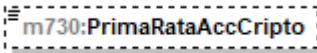
diagram	
type	DatoNP_Type

element **Primo_Modulo_PL_Type/Prospetto/LiquidazioneImposteSost/SecondaRataAccCripto**

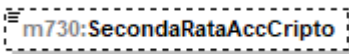
diagram	
type	DatoNP_Type

element **Primo_Modulo_PL_Type/Prospetto/LiquidazioneImposteSost/Esitolvie**

<p>diagram</p>	<pre> classDiagram class m730Esitolvie class m730Esito_Sost_Type { m730ImpostaDovuta m730EccedenzaPrecDic m730AccontiVersati m730ImpostaDebito m730ImpostaCredito m730EccedenzaVers m730CreditoComp m730Rimborso } m730Esitolvie -- m730Esito_Sost_Type </pre>
<p>type</p>	<p>m730:Esito_Sost_Type</p>
<p>children</p>	<p>m730:ImpostaDovuta m730:EccedenzaPrecDic m730:AccontiVersati m730:ImpostaDebito m730:ImpostaCredito m730:EccedenzaVers m730:CreditoComp m730:Rimborso</p>

element **Primo_Modulo_PL_Type/Prospetto/LiquidazioneImposteSost/PrimaRataAcclvie**

<p>diagram</p>	<pre> classDiagram class m730PrimaRataAcclvie </pre>
<p>type</p>	<p>DatoNP_Type</p>

element **Primo_Modulo_PL_Type/Prospetto/LiquidazioneImposteSost/SecondaRataAcclvie**

<p>diagram</p>	<pre> classDiagram class m730SecondaRataAcclvie </pre>
<p>type</p>	<p>DatoNP_Type</p>

element **Primo_Modulo_PL_Type/Prospetto/LiquidazioneImposteSost/Esitolvafe**

<p>diagram</p>	
<p>type</p>	<p>m730:Esito_Sost_Type</p>
<p>children</p>	<p>m730:ImpostaDovuta m730:EccedenzaPrecDic m730:AccontiVersati m730:ImpostaDebito m730:ImpostaCredito m730:EccedenzaVers m730:CreditoComp m730:Rimborso</p>

element **Primo_Modulo_PL_Type/Prospetto/LiquidazioneImposteSost/PrimaRataAcclvafe**

<p>diagram</p>	
<p>type</p>	<p>DatoNP_Type</p>

element **Primo_Modulo_PL_Type/Prospetto/LiquidazioneImposteSost/SecondaRataAcclvafe**

<p>diagram</p>	
<p>type</p>	<p>DatoNP_Type</p>

element **Primo_Modulo_PL_Type/Prospetto/LiquidazioneImposteSost/EsitoCapitaleFonteEstera**

<p>diagram</p>	
<p>children</p>	<p>m730:ImpostaDebito m730:EccedenzaVers m730:CreditoComp m730:Rimborso</p>

element

Primo_Modulo_PL_Type/Prospetto/LiquidazioneImposteSost/EsitoCapitaleFonteEstera/ImpostaDebito

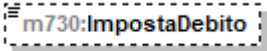
diagram	
type	DatoNP_Type

element

Primo_Modulo_PL_Type/Prospetto/LiquidazioneImposteSost/EsitoCapitaleFonteEstera/EccedenzaVers

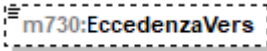
diagram	
type	DatoNP_Type

element

Primo_Modulo_PL_Type/Prospetto/LiquidazioneImposteSost/EsitoCapitaleFonteEstera/CreditoComp

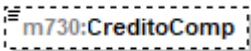
diagram	
type	DatoNP_Type

element

Primo_Modulo_PL_Type/Prospetto/LiquidazioneImposteSost/EsitoCapitaleFonteEstera/Rimborso

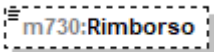
diagram	
type	DatoNP_Type

element **Primo_Modulo_PL_Type/Prospetto/LiquidazioneImposteSost/EsitoMance**

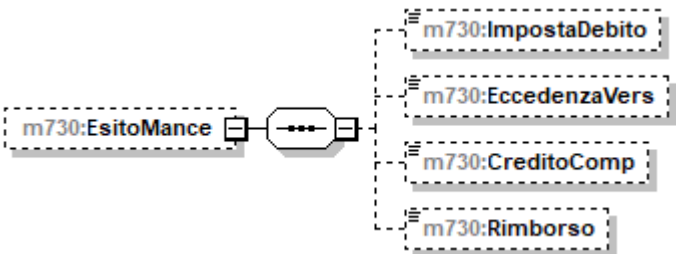
diagram	
children	m730:ImpostaDebito m730:EccedenzaVers m730:CreditoComp m730:Rimborso

element **Primo_Modulo_PL_Type/Prospetto/LiquidazioneImposteSost/EsitoMance/ImpostaDebito**

diagram	
type	DatoNP_Type

element **Primo_Modulo_PL_Type/Prospetto/LiquidazioneImposteSost/EsitoMance/EccedenzaVers**

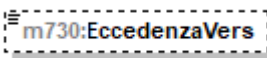
diagram	
type	DatoNP_Type

element **Primo_Modulo_PL_Type/Prospetto/LiquidazioneImposteSost/EsitoMance/CreditoComp**

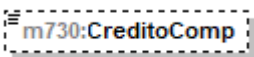
diagram	
type	DatoNP_Type

element **Primo_Modulo_PL_Type/Prospetto/LiquidazioneImposteSost/EsitoMance/Rimborso**

diagram	
type	DatoNP_Type

element **Primo_Modulo_PL_Type/ProspettoRideterminato**

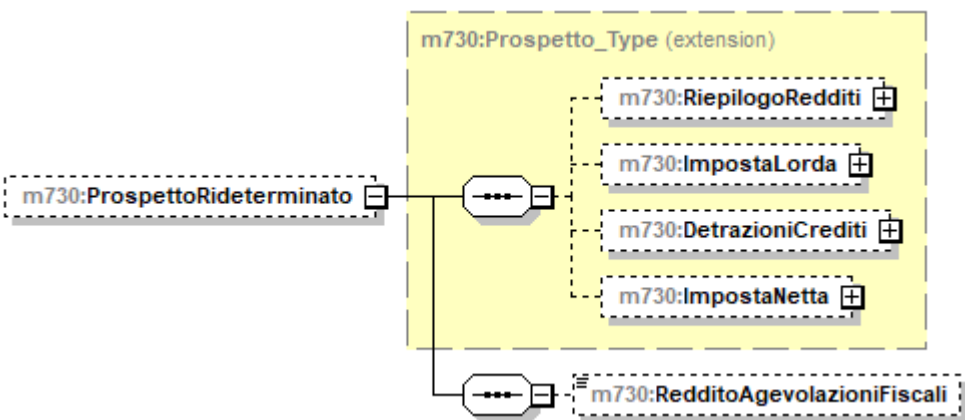
diagram	
type	extension of m730:Prospetto_Type
children	m730:RiepilogoRedditi m730:ImpostaLorda m730:DetrazioniCrediti m730:ImpostaNetta m730:RedditoAgevolazioniFiscali

element **Primo_Modulo_PL_Type/ProspettoRideterminato/RedditoAgevolazioniFiscali**

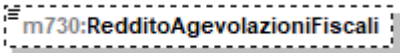
diagram	
type	DatoNP_Type

complexType **Prospetto_Annotazioni_Type**

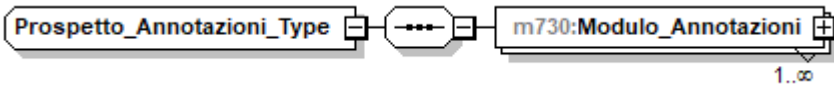
diagram	
children	m730:Modulo_Annotazioni

element **Prospetto_Annotazioni_Type/Modulo_Annotazioni**

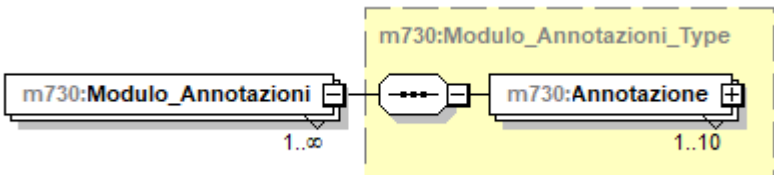
diagram	
type	m730:Modulo_Annotazioni_Type
children	m730:Annotazione

complexType **Prospetto_Liquidazione_Type**

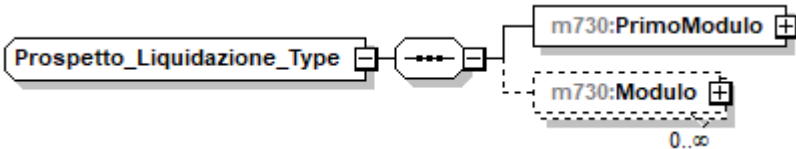
diagram	
children	m730:PrimoModulo m730:Modulo

element **Prospetto_Liquidazione_Type/PrimoModulo**

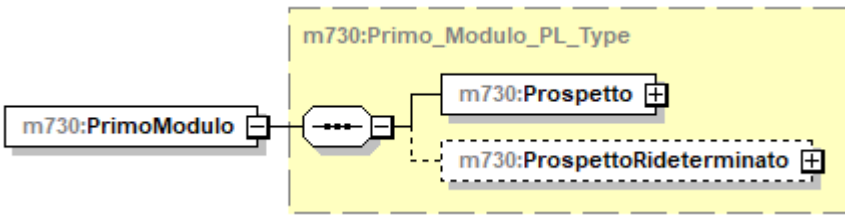
diagram	
type	m730:Primo_Modulo_PL_Type
children	m730:Prospetto m730:ProspettoRideterminato

element **Prospetto_Liquidazione_Type/Modulo**

diagram	<p>The diagram shows a dashed box labeled 'm730:Modulo' with a multiplicity of '0..∞'. This box is connected via a line with a crow's foot notation to a central box labeled 'm730:Modulo_PL_Type'. This central box is further connected to another dashed box labeled 'm730:CredImpEestero'.</p>
type	m730:Modulo_PL_Type
children	m730:CredImpEestero

complexType **Prospetto_Type**

diagram	<p>The diagram shows a box labeled 'Prospetto_Type' connected via a line with a crow's foot notation to a central container box. This container box is connected to four separate dashed boxes, each representing a child element: 'm730:RiepilogoRedditi', 'm730:ImpostaLorda', 'm730:DetrazioniCrediti', and 'm730:ImpostaNetta'.</p>
children	m730:RiepilogoRedditi m730:ImpostaLorda m730:DetrazioniCrediti m730:ImpostaNetta

element **Prospetto_Type/RiepilogoRedditi**

diagram	<p>The diagram shows a dashed box labeled 'm730:RiepilogoRedditi' connected via a line with a crow's foot notation to a large dashed box labeled 'm730:Riepilogo_Redditi_Type'. Inside this large box, there is a list of ten sub-elements, each in a dashed box: 'm730:Dominicali', 'm730:Agrari', 'm730:Fabbricati', 'm730:LavDip', 'm730:AltriRedditi', 'm730:ImponibileCedolare', 'm730:ImponibileCedolareOrdina...', 'm730:ImponibileCedolareAgevo...', 'm730:AbitazionePrincipalePertin...', and 'm730:CapitaleFonteEstera'.</p>
type	m730:Riepilogo_Redditi_Type

children	m730:Dominicali m730:Agrari m730:Fabbricati m730:LavDip m730:AltriRedditi m730:ImponibileCedolare m730:ImponibileCedolareOrdinario m730:ImponibileCedolareAgevolato m730:AbitazionePrincipalePertinenze m730:CapitaleFonteEstera
----------	--

element **Prospetto_Type/ImpostaLorda**

diagram	<pre> classDiagram class m730ImpostaLorda class m730Imposta_Lorda_Type class m730RedditoComplessivo class m730DeduzioneAbitazPrincipale class m730OneriDeducibili class m730RedditoImponibile class m730CompensiAttSport class m730ImportoImpostaLorda m730ImpostaLorda "1" *-- "1" m730Imposta_Lorda_Type m730Imposta_Lorda_Type "1" *-- "1" m730RedditoComplessivo m730Imposta_Lorda_Type "1" *-- "1" m730DeduzioneAbitazPrincipale m730Imposta_Lorda_Type "1" *-- "1" m730OneriDeducibili m730Imposta_Lorda_Type "1" *-- "1" m730RedditoImponibile m730Imposta_Lorda_Type "1" *-- "1" m730CompensiAttSport m730Imposta_Lorda_Type "1" *-- "1" m730ImportoImpostaLorda </pre>
type	m730:Imposta_Lorda_Type
children	m730:RedditoComplessivo m730:DeduzioneAbitazPrincipale m730:OneriDeducibili m730:RedditoImponibile m730:CompensiAttSport m730:ImportoImpostaLorda

element **Prospetto_Type/DetrazioniCrediti**

diagram

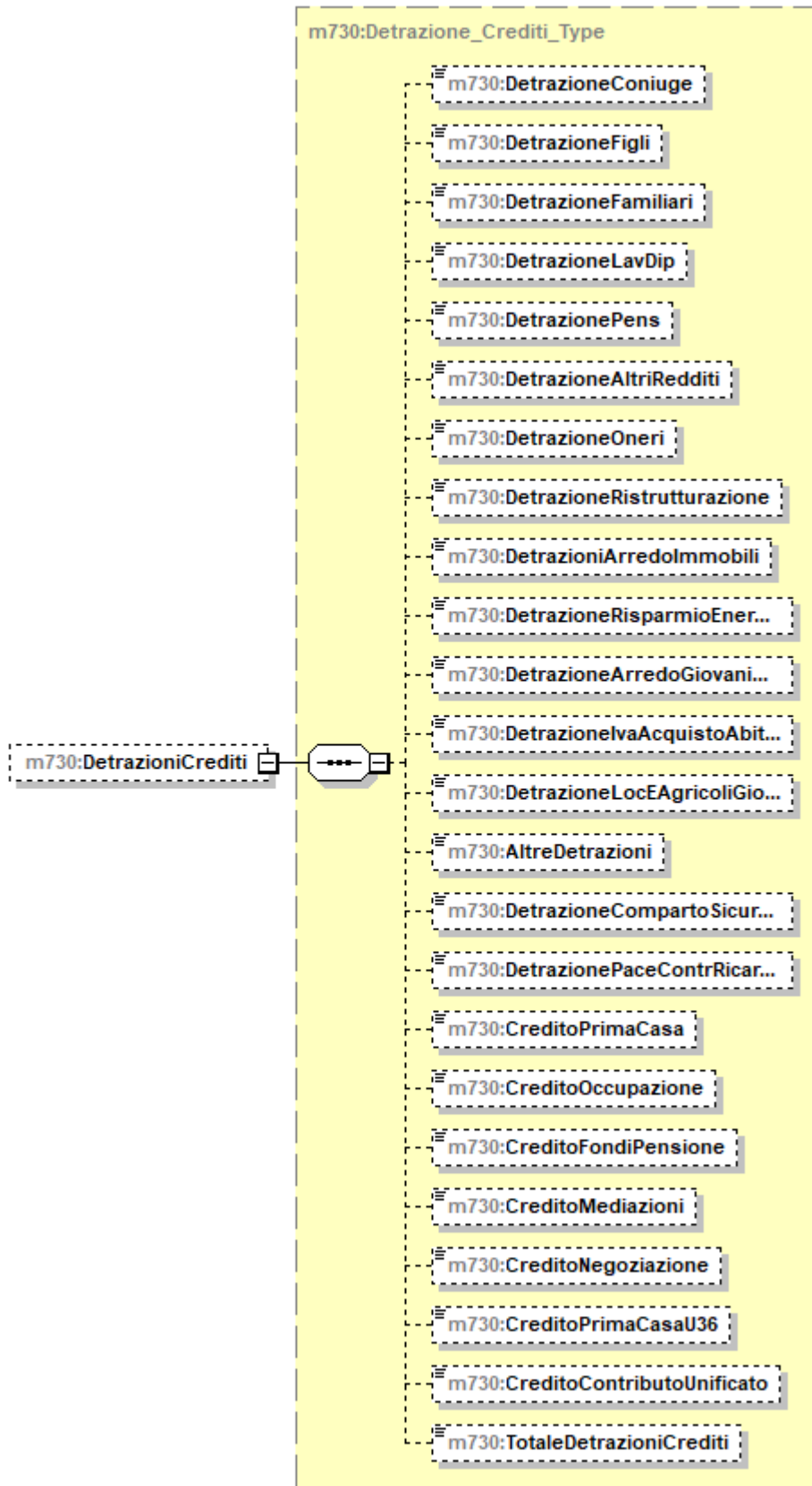

type	m730:Detrazione_Crediti_Type
children	m730:DetrazioneConiuge m730:DetrazioneFigli m730:DetrazioneFamiliari m730:DetrazioneLavDip m730:DetrazionePens m730:DetrazioneAltriRedditi m730:DetrazioneOneri m730:DetrazioneRistrutturazione m730:DetrazioniArredolmobili m730:DetrazioneRisparmioEnergetico m730:DetrazioneArredoGiovaniCoppie m730:DetrazioneIvaAcquistoAbitaz m730:DetrazioneLocEAgricoliGiovani m730:AltreDetrazioni m730:DetrazioneCompartoSicurezza m730:DetrazionePaceContrRicarica m730:CreditoPrimaCasa m730:CreditoOccupazione m730:CreditoFondiPensione m730:CreditoMediazioni m730:CreditoNegoziazione m730:CreditoPrimaCasaU36 m730:CreditoContributoUnificato m730:TotaleDetrazioniCrediti

element **Prospetto_Type/ImpostaNetta**

diagram	
type	m730:Imposta_Netta_Type
children	m730:ImportoImpostaNetta m730:CredAltriSisma m730:CredAbitazSisma m730:CredImpEstere m730:CredErogCultura m730:CredErogScuola m730:CredVideosorveglianza m730:AltriCrediti m730:CredDetrazIncapienti m730:Ritenute m730:Differenza m730:EccedenzaIrpEf m730:AccontiVersati m730:CredRimborsatiSost m730:TrattamentoIntSpettante m730:TrattamentoIntRiconosciuto m730:RestituzioneTrattamentoInt

	m730:CredRimborsatiSost m730:TrattamentoIntSpettante m730:TrattamentoIntRiconosciuto m730:RestituzioneTrattamentoInt
--	---

complexType **Quadro_I_Type**

diagram	
children	m730:UtilizzoF24 m730:UtilizzoF24Sost

element **Quadro_I_Type/UtilizzoF24**

diagram	
type	m730:Compensazione_Type
children	m730:Importo m730:Casella

element **Quadro_I_Type/UtilizzoF24Sost**

diagram	
type	m730:Compensazione_Type
children	m730:Importo m730:Casella

complexType **Quadro_K_Type**

diagram	
	0..6

children	m730:DatiCondominio m730:DatiCatastali m730:DomandaAccatamento m730:DatiFornitore
----------	---

element **Quadro_K_Type/DatiCondominio**

diagram	
type	m730:Dati_Condominio_Type
children	m730:CodiceFiscale m730:Denominazione

element **Quadro_K_Type/DatiCatastali**

diagram	
type	m730:Dati_Catastali_Type
children	m730:CodiceComune m730:TerreniUrbano m730:SezioneUrbanaComuneCatastale m730:Foglio m730:Particella m730:Subalterno

element **Quadro_K_Type/DomandaAccatamento**

diagram	
type	m730:Domanda_Accatamento_Type

children	m730:Data m730:Numero m730:ProvinciaUfficio
----------	---

element **Quadro_K_Type/DatiFornitore**

diagram	
type	m730:Dati_Fornitore_Type
children	m730:CodiceFiscale m730:CognomeDenom m730:Nome m730:Sesso m730:DataNascita m730:ComuneNascita m730:ProvinciaNascita m730:ImportoAcquisti m730:StatoEstero

complexType **Rappresentante_Type**

diagram	
children	m730:SoggettoFiscale m730:DatiAnagrafici m730:ResidenzaAnagrafica m730:Firma m730:DataCaricaErede

element **Rappresentante_Type/SoggettoFiscale**

<p>diagram</p>	
<p>type</p>	<p>m730:Soggetto_Fiscale_730_Type</p>
<p>children</p>	<p>m730:CodiceFiscale m730:Email m730:Telefono m730:Cellulare</p>

element **Rappresentante_Type/DatiAnagrafici**

<p>diagram</p>	
<p>type</p>	<p>Dati_Anagrafici_Type</p>
<p>children</p>	<p>Cognome Nome Sesso DataNascita ComuneNascita ProvinciaNascita</p>

element **Rappresentante_Type/ResidenzaAnagrafica**

<p>diagram</p>	
<p>type</p>	<p>m730:Residenza_Rappresentante_Type</p>
<p>children</p>	<p>Comune Provincia CodiceComune Indirizzo Cap m730:Tipologia m730:NumCivico m730:Frazione</p>

element **Rappresentante_Type/Firma**

<p>diagram</p>	
<p>type</p>	<p>DatoCB_Type</p>

element **Rappresentante_Type/DataCaricaErede**

<p>diagram</p>	
<p>type</p>	<p>DatoDT_Type</p>

complexType **Redditi_Capitale_Sost_Type**

<p>diagram</p>	
<p>children</p>	<p>m730:Tipo m730:CodiceStatoEstero m730:AmmontareReddito m730:Aliquota m730:Creditolvca m730:OpzioneOrdinaria m730:ProventiParticolari m730:EccedenzaVersamento</p>

element **Redditi_Capitale_Sost_Type/Tipo**

<p>diagram</p>	
<p>type</p>	<p>DatoAN_Type</p>

element **Redditi_Capitale_Sost_Type/CodiceStatoEstero**

<p>diagram</p>	
<p>type</p>	<p>DatoAN_Type</p>

element **Redditi_Capitale_Sost_Type/AmmontareReddito**

<p>diagram</p>	
<p>type</p>	<p>DatoNP_Type</p>

element **Redditi_Capitale_Sost_Type/Aliquota**

<p>diagram</p>	
<p>type</p>	<p>DatoPC_Type</p>

element **Redditi_Capitale_Sost_Type/Creditolvca**

diagram	
type	DatoNP_Type

element **Redditi_Capitale_Sost_Type/OpzioneOrdinaria**

diagram	
type	DatoCB_Type

element **Redditi_Capitale_Sost_Type/ProventiParticolari**

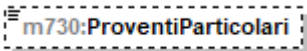
diagram	
type	DatoCB_Type

element **Redditi_Capitale_Sost_Type/EccedenzaVersamento**

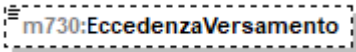
diagram	
type	DatoNP_Type

complexType **Redditi_Capitale_Type**

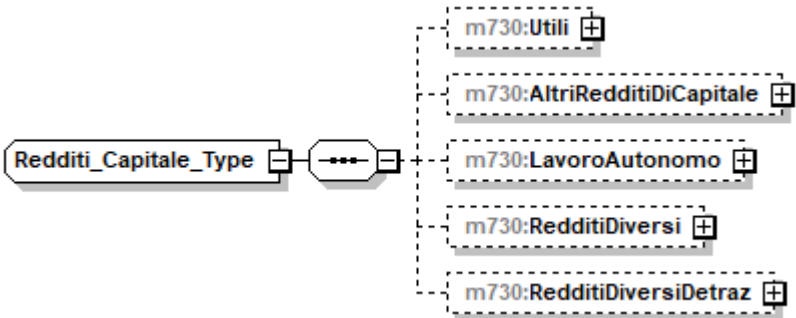
diagram	
children	m730:Utili m730:AltriRedditiDiCapitale m730:LavoroAutonomo m730:RedditiDiversi m730:RedditiDiversiDetraz

element **Redditi_Capitale_Type/Utili**

diagram	
type	m730:Altri_Redditi_Utili_Type
children	m730:Tipo_Reddito m730:RedditiRitenute

element **Redditi_Capitale_Type/AltriRedditiDiCapitale**

diagram	
type	m730:Sezione_Altri_Reddi_Type
children	m730:TipoReddito m730:RedditiRitenute

element **Redditi_Capitale_Type/LavoroAutonomo**

diagram	
type	m730:Altri_Redditi_Lavoro_Autonomo_Type
children	m730:AltriDati m730:TipoReddito m730:RedditiRitenute

element **Redditi_Capitale_Type/RedditiDiversi**

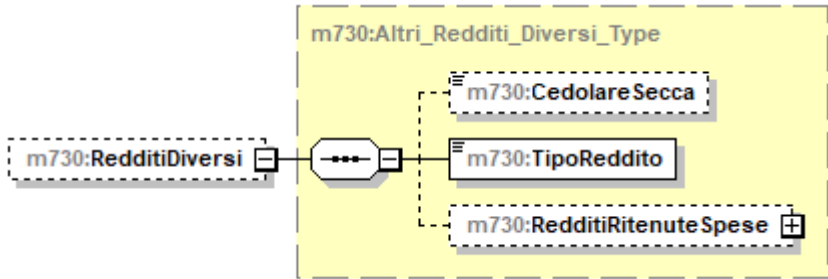
diagram	
type	m730:Altri_Redditi_Diversi_Type
children	m730:CedolareSecca m730:TipoReddito m730:RedditiRitenuteSpese

element **Redditi_Capitale_Type/RedditiDiversiDetraz**

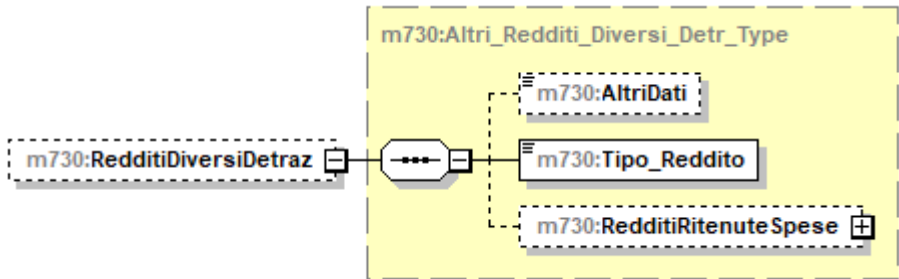
diagram	
type	m730:Altri_Redditi_Diversi_Detr_Type
children	m730:AltriDati m730:Tipo_Reddito m730:RedditiRitenuteSpese

complexType **Redditi_Eredi_Legatari_Type**

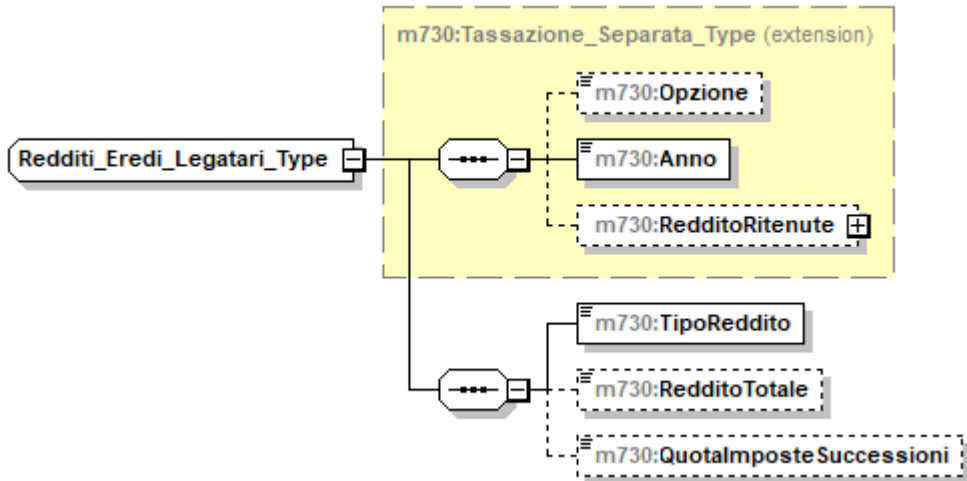
diagram	
type	extension of m730:Tassazione_Separata_Type
children	m730:Opzione m730:Anno m730:RedditoRitenute m730:TipoReddito m730:RedditoTotale m730:QuotalmposteSuccessioni

element **Redditi_Eredi_Legatari_Type/TipoReddito**

diagram																																	
type	restriction of DatoNP_Type																																
facets	<table border="1"> <thead> <tr> <th>Kind</th> <th>Value</th> </tr> </thead> <tbody> <tr><td>enumeration</td><td>1</td></tr> <tr><td>enumeration</td><td>2</td></tr> <tr><td>enumeration</td><td>3</td></tr> <tr><td>enumeration</td><td>4</td></tr> <tr><td>enumeration</td><td>5</td></tr> <tr><td>enumeration</td><td>6</td></tr> <tr><td>enumeration</td><td>7</td></tr> <tr><td>enumeration</td><td>8</td></tr> <tr><td>enumeration</td><td>9</td></tr> <tr><td>enumeration</td><td>10</td></tr> <tr><td>enumeration</td><td>11</td></tr> <tr><td>enumeration</td><td>12</td></tr> <tr><td>enumeration</td><td>13</td></tr> <tr><td>enumeration</td><td>14</td></tr> <tr><td>enumeration</td><td>15</td></tr> </tbody> </table>	Kind	Value	enumeration	1	enumeration	2	enumeration	3	enumeration	4	enumeration	5	enumeration	6	enumeration	7	enumeration	8	enumeration	9	enumeration	10	enumeration	11	enumeration	12	enumeration	13	enumeration	14	enumeration	15
Kind	Value																																
enumeration	1																																
enumeration	2																																
enumeration	3																																
enumeration	4																																
enumeration	5																																
enumeration	6																																
enumeration	7																																
enumeration	8																																
enumeration	9																																
enumeration	10																																
enumeration	11																																
enumeration	12																																
enumeration	13																																
enumeration	14																																
enumeration	15																																

element **Redditi_Eredi_Legatari_Type/RedditoTotale**

diagram	
type	DatoNP_Type

element **Redditi_Eredi_Legatari_Type/QuotalImposteSuccessioni**

diagram	
type	DatoNP_Type

complexType **Redditi_Fabbricati_Type**

diagram	
children	m730:Modulo

element **Redditi_Fabbricati_Type/Modulo**

diagram	<p>The diagram shows a box labeled 'm730:Modulo' with a multiplicity of '1..∞'. A line connects it to a larger box labeled 'm730:Modulo_Fabbricato_Type'. Inside this box, there are two sub-elements: 'm730:FabbricatoOrd' with a multiplicity of '0..6' and 'm730:FabbricatoAgev'.</p>
type	m730:Modulo_Fabbricato_Type
children	m730:FabbricatoOrd m730:FabbricatoAgev

complexType **Redditi_Lavoro_Dip_Type**

diagram	<p>The diagram shows a box labeled 'Redditi_Lavoro_Dip_Type' with the text 'Quadro C - Redditi di Lavoro Dipendente e Assimilati' below it. A line connects it to a box labeled 'm730:PrimoModulo'. Another line connects it to a box labeled 'm730:Modulo' with a multiplicity of '0..∞'.</p>
children	m730:PrimoModulo m730:Modulo

element **Redditi_Lavoro_Dip_Type/PrimoModulo**

diagram	<p>The diagram shows a box labeled 'm730:PrimoModulo' connected to a large dashed box labeled 'm730:Primo_Modulo_Lavoro_Dip_Type'. Inside this dashed box, there are several sub-elements: 'm730:LavoroDipendente' (0..3), 'm730:PremiRisultato', 'm730:PeriodoLavoro', 'm730:AltriRedditiAssLavDip' (0..3), 'm730:RitenuteLavoroDipendente', 'm730:RiduzionePressioneFiscale', 'm730:CasellaCasiParticolari', 'm730:StatoEstero', 'm730:CompartoSicurezza', and 'm730:Mance'.</p>
---------	--

type	m730:Primo Modulo Lavoro Dip Type
children	m730:LavoroDipendente m730:PremiRisultato m730:PeriodoLavoro m730:AltriRedditiAssLavDip m730:RitenuteLavoroDipendente m730:RiduzionePressioneFiscale m730:CasellaCasiParticolari m730:StatoEstero m730:CompartoSicurezza m730:Mance

element **Redditi_Lavoro_Dip_Type/Modulo**

diagram	
type	m730:Modulo Lavoro Dip Type
children	m730:LavoroDipendente m730:PremiRisultato m730:AltriRedditiAssLavDip m730:Mance

complexType **Redditi_Ritenute_Spese_Type**

diagram	
type	extension of m730:Redditi_Ritenute_Type
children	m730:ImportoRedditi m730:ImportoRitenute m730:ImportoSpese

element **Redditi_Ritenute_Spese_Type/ImportoSpese**

diagram	
type	DatoNP_Type

complexType **Redditi_Ritenute_Type**

diagram	
children	m730:ImportoRedditi m730:ImportoRitenute

element **Redditi_Ritenute_Type/ImportoRedditi**

diagram	
type	DatoNP_Type

element **Redditi_Ritenute_Type/ImportoRitenute**

diagram	
type	DatoNP_Type

complexType **Redditi_Tassazione_Separata_Type**

diagram	
children	m730:RedditiErede m730:ImposteRimborsate

element **Redditi_Tassazione_Separata_Type/RedditiErede**

diagram	
type	m730:Redditi_Eredi_Legatari_Type

children	m730:Opzione m730:Anno m730:RedditoRitenute m730:TipoReddito m730:RedditoTotale m730:QuotaImposteSuccessioni
----------	---

element **Redditi_Tassazione_Separata_Type/ImposteRimborsate**

diagram	
type	m730:Imposte_Rimborsate_Type
children	m730:TipoReddito m730:TassazioneSeparata

complexType **Redditi_Terreni_Type**

diagram	
children	m730:Modulo

element **Redditi_Terreni_Type/Modulo**

diagram	
type	m730:Modulo_Terreno_Type
children	m730:Terreno

complexType **Reddito_Campione_Franchi_Type**

diagram	
children	m730:Codice m730:Importo

element **Reddito_Campione_Franchi_Type/Codice**

diagram	
---------	--

type	restriction of DatoNP_Type												
facets	<table border="1"> <thead> <tr> <th>Kind</th> <th>Value</th> </tr> </thead> <tbody> <tr> <td>enumeration</td> <td>1</td> </tr> <tr> <td>enumeration</td> <td>2</td> </tr> <tr> <td>enumeration</td> <td>3</td> </tr> <tr> <td>enumeration</td> <td>4</td> </tr> <tr> <td>enumeration</td> <td>5</td> </tr> </tbody> </table>	Kind	Value	enumeration	1	enumeration	2	enumeration	3	enumeration	4	enumeration	5
Kind	Value												
enumeration	1												
enumeration	2												
enumeration	3												
enumeration	4												
enumeration	5												

element **Reddito_Campione_Franchi_Type/Importo**

diagram	
type	DatoNP_Type

complexType **Reddito_Campione_Type**

diagram	
children	m730:Codice m730:Importo

element **Reddito_Campione_Type/Codice**

diagram											
type	restriction of DatoNP_Type										
facets	<table border="1"> <thead> <tr> <th>Kind</th> <th>Value</th> </tr> </thead> <tbody> <tr> <td>enumeration</td> <td>1</td> </tr> <tr> <td>enumeration</td> <td>2</td> </tr> <tr> <td>enumeration</td> <td>3</td> </tr> <tr> <td>enumeration</td> <td>6</td> </tr> </tbody> </table>	Kind	Value	enumeration	1	enumeration	2	enumeration	3	enumeration	6
Kind	Value										
enumeration	1										
enumeration	2										
enumeration	3										
enumeration	6										

element **Reddito_Campione_Type/Importo**

diagram	
type	DatoNP_Type

complexType **Reddito_Erede_Type**

diagram	
type	extension of m730:Tassazione_Separata_Type
children	m730:Opzione m730:Anno m730:RedditoRitenute

complexType **Residenza_Anagrafica_730_Type**

diagram	
type	extension of Residenza_Anagrafica_Type
children	Comune Provincia CodiceComune Indirizzo Cap DataVariazione m730:Tipologia m730:NumCivico m730:Frazione m730:PrimaPresentazione

element **Residenza_Anagrafica_730_Type/Tipologia**

diagram	
type	DatoAN_Type

element **Residenza_Anagrafica_730_Type/NumCivico**

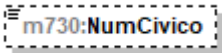
diagram	
type	DatoAN_Type

element **Residenza_Anagrafica_730_Type/Frazione**

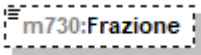
diagram	
type	DatoAN_Type

element **Residenza_Anagrafica_730_Type/PrimaPresentazione**

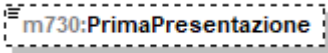
diagram	
type	DatoCB_Type

complexType **Residenza_Rappresentante_Type**

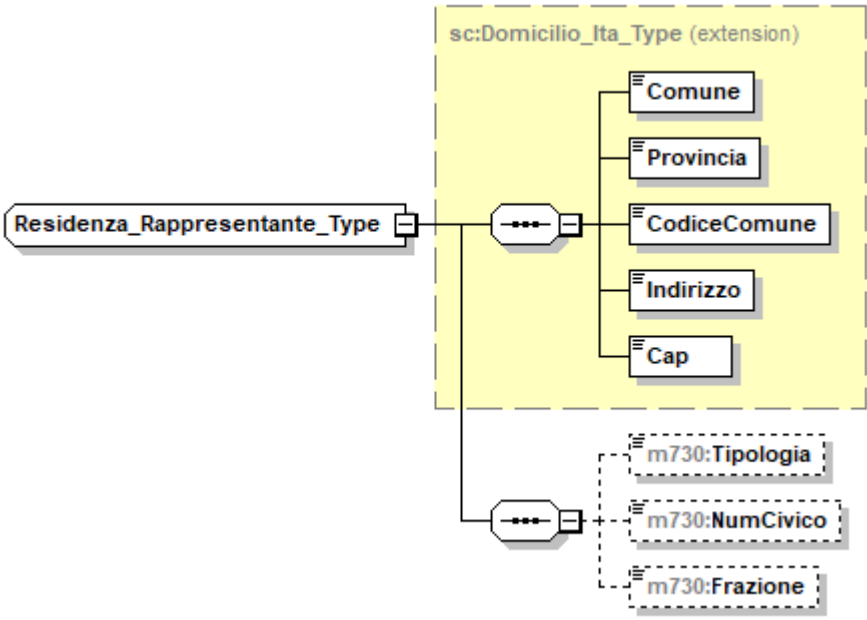
diagram	 <p>The diagram illustrates the structure of the Residenza_Rappresentante_Type complex type. It is an extension of the sc:Domicilio_Ita_Type (extension). The base type includes the following elements: Comune, Provincia, CodiceComune, Indirizzo, and Cap. The extended type also includes the following elements: m730:Tipologia, m730:NumCivico, and m730:Frazione.</p>
type	extension of Domicilio_Ita_Type
children	Comune Provincia CodiceComune Indirizzo Cap m730:Tipologia m730:NumCivico m730:Frazione

element **Residenza_Rappresentante_Type/Tipologia**

diagram	
type	DatoAN_Type

element **Residenza_Rappresentante_Type/NumCivico**

diagram	
type	DatoAN_Type

element **Residenza_Rappresentante_Type/Frazione**

diagram	
type	DatoAN_Type

complexType **Residenza_Type**

diagram	<p>The diagram shows a complex type 'Residenza_Type' represented by a rounded rectangle. To its right is a dashed-line container representing the type's content model. Inside this container, a sequence of child elements is listed: m730:Comune, m730:Provincia, m730:CodiceComune, m730:Cap, m730:Tipologia, m730:Indirizzo, m730:NumCivico, m730:Frazione, m730:Email, and m730:Telefono. Each child element is shown in a dashed-line box. A small connector box with a dashed line is positioned between the 'Residenza_Type' box and the first child element, indicating the sequence of elements.</p>
children	m730:Comune m730:Provincia m730:CodiceComune m730:Cap m730:Tipologia m730:Indirizzo m730:NumCivico m730:Frazione m730:Email m730:Telefono

element **Residenza_Type/Comune**

diagram	
---------	--

type	DatoAN Type
------	-----------------------------

element **Residenza_Type/Provincia**

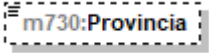
diagram	
type	PR Type

element **Residenza_Type/CodiceComune**

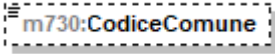
diagram	
type	DatoAN Type

element **Residenza_Type/Cap**

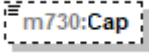
diagram	
type	DatoAN Type

element **Residenza_Type/Tipologia**

diagram	
type	DatoAN Type

element **Residenza_Type/Indirizzo**

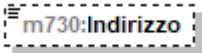
diagram	
type	DatoAN Type

element **Residenza_Type/NumCivico**

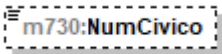
diagram	
type	DatoAN Type

element **Residenza_Type/Frazione**

diagram	
---------	---

type	DatoAN Type
------	-----------------------------

element **Residenza_Type/Email**

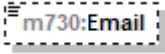
diagram	
type	DatoEM Type

element **Residenza_Type/Telefono**

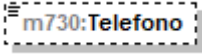
diagram	
type	DatoAN Type

complexType **Residuo_Credito_Compens_AnnoImposta_Type**

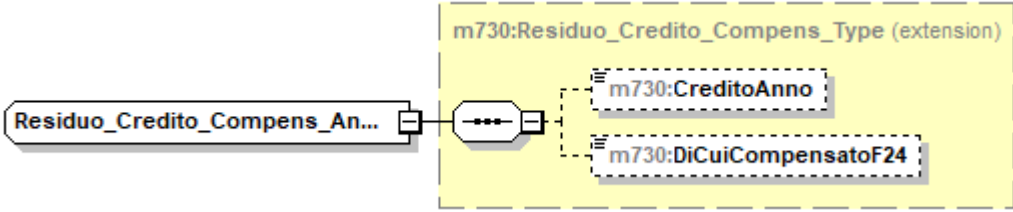
diagram	
type	extension of m730:Residuo_Credito_Compens_Type
children	m730:CreditoAnno m730:DiCuiCompensatoF24

complexType **Residuo_Credito_Compens_Type**

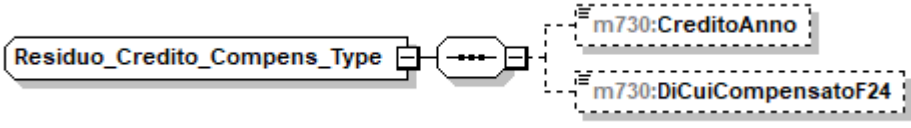
diagram	
children	m730:CreditoAnno m730:DiCuiCompensatoF24

element **Residuo_Credito_Compens_Type/CreditoAnno**

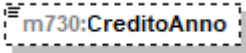
diagram	
type	DatoNP Type

element **Residuo_Credito_Compens_Type/DiCuiCompensatoF24**

diagram	
type	DatoNP_Type

complexType **Residuo_Fabbricati_Type**

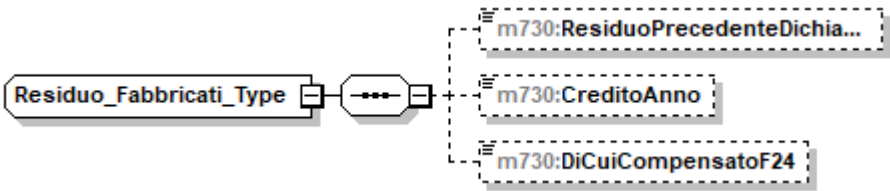
diagram	
children	m730:ResiduoPrecedenteDichiarazione m730:CreditoAnno m730:DiCuiCompensatoF24

element **Residuo_Fabbricati_Type/ResiduoPrecedenteDichiarazione**

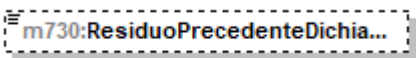
diagram	
type	DatoNP_Type

element **Residuo_Fabbricati_Type/CreditoAnno**

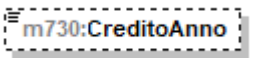
diagram	
type	DatoNP_Type

element **Residuo_Fabbricati_Type/DiCuiCompensatoF24**

diagram	
type	DatoNP_Type

complexType **Residuo_Onlus_Type**

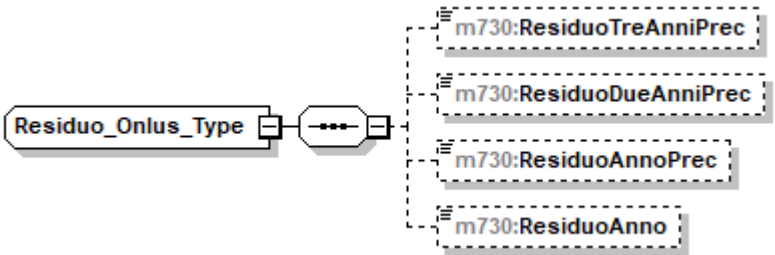
diagram	
children	m730:ResiduoTreAnniPrec m730:ResiduoDueAnniPrec m730:ResiduoAnnoPrec m730:ResiduoAnno

element **Residuo_Onlus_Type/ResiduoTreAnniPrec**

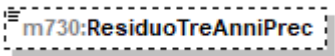
diagram	
type	DatoNP_Type

element **Residuo_Onlus_Type/ResiduoDueAnniPrec**

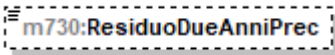
diagram	
type	DatoNP_Type

element **Residuo_Onlus_Type/ResiduoAnnoPrec**

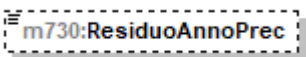
diagram	
type	DatoNP_Type

element **Residuo_Onlus_Type/ResiduoAnno**

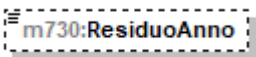
diagram	
type	DatoNP_Type

complexType **Restituzione_Somme_Type**

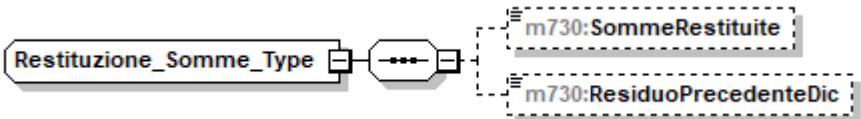
diagram	
children	m730:SommeRestituite m730:ResiduoPrecedenteDic

element **Restituzione_Somme_Type/SommeRestituite**

diagram	
type	DatoNP_Type

element **Restituzione_Somme_Type/ResiduoPrecedenteDic**

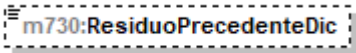
diagram	
type	DatoNP_Type

complexType **Rettifica_Type**

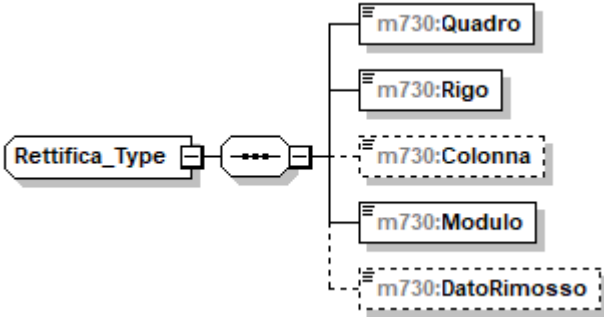
diagram	
children	m730:Quadro m730:Rigo m730:Colonna m730:Modulo m730:DatoRimosso

element **Rettifica_Type/Quadro**

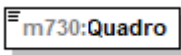
diagram	
type	DatoAN_Type

element **Rettifica_Type/Rigo**

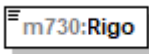
diagram	
type	DatoNP_Type

element **Rettifica_Type/Colonna**

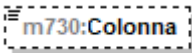
diagram	
type	DatoNP_Type

element **Rettifica_Type/Modulo**

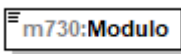
diagram	
type	DatoNP_Type

element **Rettifica_Type/DatoRimosso**

diagram	
type	DatoCB_Type

complexType **Riduzione_Pressione_Type**

diagram	
children	m730:CodiceTrattamento m730:TrattamentoErogato m730:EsenzioneRicercatori m730:EsenzioneImpatriati

element **Riduzione_Pressione_Type/CodiceTrattamento**

diagram							
type	restriction of DatoN1_Type						
facets	<table border="1"> <thead> <tr> <th>Kind</th> <th>Value</th> </tr> </thead> <tbody> <tr> <td>enumeration</td> <td>1</td> </tr> <tr> <td>enumeration</td> <td>2</td> </tr> </tbody> </table>	Kind	Value	enumeration	1	enumeration	2
Kind	Value						
enumeration	1						
enumeration	2						

element **Riduzione_Pressione_Type/TrattamentoErogato**

diagram	
type	DatoNP_Type

element **Riduzione_Pressione_Type/EsenzioneRicercatori**

diagram	
type	DatoNP_Type

element **Riduzione_Pressione_Type/EsenzioneImpatriati**

diagram	
type	DatoNP_Type

complexType **Riepilogo_Redditi_Type**

<p>diagram</p>	
<p>children</p>	<p>m730:Dominicali m730:Agrari m730:Fabbricati m730:LavDip m730:AltriRedditi m730:ImponibileCedolare m730:ImponibileCedolareOrdinario m730:ImponibileCedolareAgevolato m730:AbitazionePrincipalePertinenze m730:CapitaleFonteEstera</p>

element **Riepilogo_Redditi_Type/Dominicali**

<p>diagram</p>	
<p>type</p>	<p>DatoNP_Type</p>

element **Riepilogo_Redditi_Type/Agrari**

<p>diagram</p>	
<p>type</p>	<p>DatoNP_Type</p>

element **Riepilogo_Redditi_Type/Fabbricati**

<p>diagram</p>	
<p>type</p>	<p>DatoNP_Type</p>

element **Riepilogo_Reddito_Type/LavDip**

diagram	
type	DatoNP_Type

element **Riepilogo_Reddito_Type/AltriRedditi**

diagram	
type	DatoNP_Type

element **Riepilogo_Reddito_Type/ImponibileCedolare**

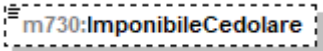
diagram	
type	DatoNP_Type

element **Riepilogo_Reddito_Type/ImponibileCedolareOrdinario**

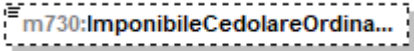
diagram	
type	DatoNP_Type

element **Riepilogo_Reddito_Type/ImponibileCedolareAgevolato**

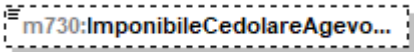
diagram	
type	DatoNP_Type

element **Riepilogo_Reddito_Type/AbitazionePrincipalePertinenze**

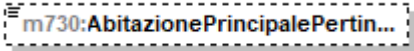
diagram	
type	DatoNP_Type

element **Riepilogo_Reddito_Type/CapitaleFonteEstera**

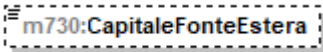
diagram	
type	DatoNP_Type

complexType **Ritenute_Acconti_Sospesi_Type**

diagram	
children	m730:CodiceEvento m730:Irpef m730:AddRegionaleIrpef m730:AddComunaleIrpef m730:SostitutivaPremi m730:CedolareSecca m730:SostitutivaRita

element **Ritenute_Acconti_Sospesi_Type/CodiceEvento**

diagram											
type	m730:Codice_Evento_Eccezionale_Type										
facets	<table border="1"> <thead> <tr> <th>Kind</th> <th>Value</th> </tr> </thead> <tbody> <tr> <td>enumeration</td> <td>1</td> </tr> <tr> <td>enumeration</td> <td>2</td> </tr> <tr> <td>enumeration</td> <td>3</td> </tr> <tr> <td>enumeration</td> <td>99</td> </tr> </tbody> </table>	Kind	Value	enumeration	1	enumeration	2	enumeration	3	enumeration	99
Kind	Value										
enumeration	1										
enumeration	2										
enumeration	3										
enumeration	99										

element **Ritenute_Acconti_Sospesi_Type/Irpef**

diagram	
type	DatoNP_Type

element **Ritenute_Acconti_Sospesi_Type/AddRegionaleIrpef**

diagram	
type	DatoNP_Type

element **Ritenute_Acconti_Sospesi_Type/AddComunaleIrpef**

diagram	
type	DatoNP_Type

element **Ritenute_Acconti_Sospesi_Type/SostitutivaPremi**

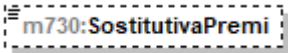
diagram	
type	DatoNP_Type

element **Ritenute_Acconti_Sospesi_Type/CedolareSecca**

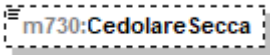
diagram	
type	DatoNP_Type

element **Ritenute_Acconti_Sospesi_Type/SostitutivaRita**

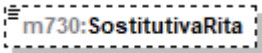
diagram	
type	DatoNP_Type

complexType **Ritenute_Lavoro_Dip_Type**

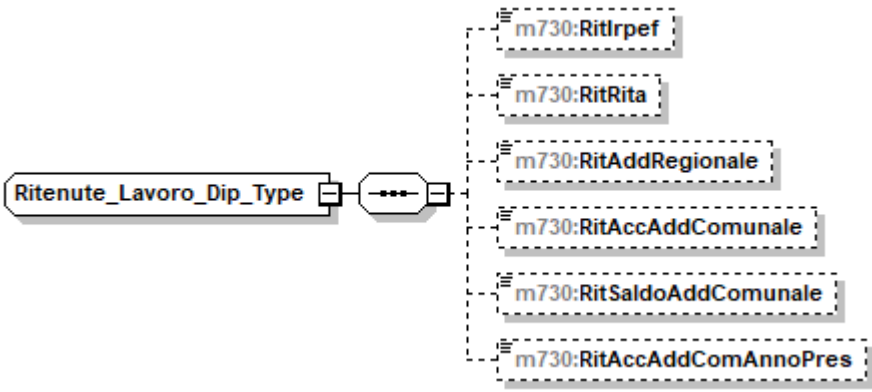
diagram	
children	m730:Ritlrpef m730:RitRita m730:RitAddRegionale m730:RitAccAddComunale m730:RitSaldoAddComunale m730:RitAccAddComAnnoPres

element **Ritenute_Lavoro_Dip_Type/Ritlrpef**

diagram	
type	DatoNP_Type

element **Ritenute_Lavoro_Dip_Type/RitRita**

diagram	
type	DatoNP_Type

element **Ritenute_Lavoro_Dip_Type/RitAddRegionale**

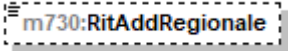
diagram	
type	DatoNP_Type

element **Ritenute_Lavoro_Dip_Type/RitAccAddComunale**

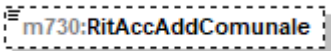
diagram	
type	DatoNP_Type

element **Ritenute_Lavoro_Dip_Type/RitSaldoAddComunale**

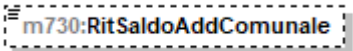
diagram	
type	DatoNP_Type

element **Ritenute_Lavoro_Dip_Type/RitAccAddComAnnoPres**

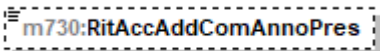
diagram	
type	DatoNP_Type

complexType **Rivalutazione_Terreni_Type**

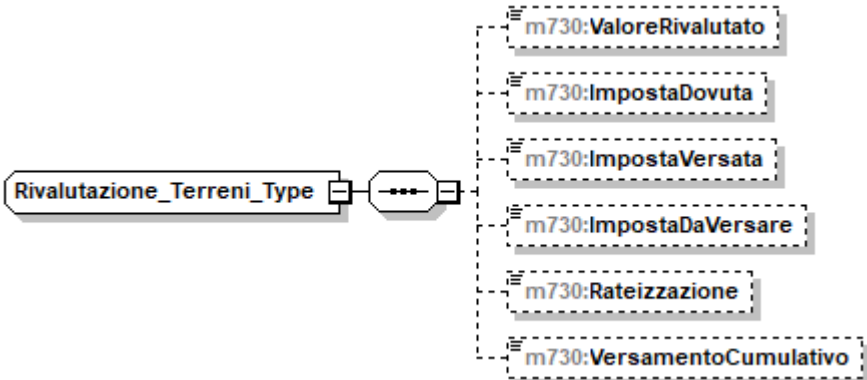
diagram	
children	m730:ValoreRivalutato m730:ImpostaDovuta m730:ImpostaVersata m730:ImpostaDaVersare m730:Rateizzazione m730:VersamentoCumulativo

	m730:VersamentoCumulativo
--	---

element **Rivalutazione_Terreni_Type/ValoreRivalutato**

diagram	
type	DatoNP_Type

element **Rivalutazione_Terreni_Type/ImpostaDovuta**

diagram	
type	DatoNP_Type

element **Rivalutazione_Terreni_Type/ImpostaVersata**

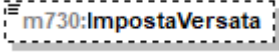
diagram	
type	DatoNP_Type

element **Rivalutazione_Terreni_Type/ImpostaDaVersare**

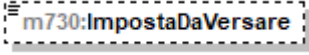
diagram	
type	DatoNP_Type

element **Rivalutazione_Terreni_Type/Rateizzazione**

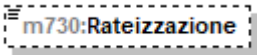
diagram	
type	DatoCB_Type

element **Rivalutazione_Terreni_Type/VersamentoCumulativo**

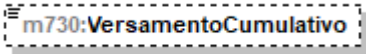
diagram	
type	DatoCB_Type

complexType **Sezione_Altri_Redd_Type**

diagram	
children	m730:TipoReddito m730:RedditiRitenute

element **Sezione_Altri_Redd_Type/TipoReddito**

diagram																			
type	m730:Tipo Reddito Da1a8 Type																		
facets	<table border="1"> <thead> <tr> <th>Kind</th> <th>Value</th> </tr> </thead> <tbody> <tr><td>enumeration</td><td>1</td></tr> <tr><td>enumeration</td><td>2</td></tr> <tr><td>enumeration</td><td>3</td></tr> <tr><td>enumeration</td><td>4</td></tr> <tr><td>enumeration</td><td>5</td></tr> <tr><td>enumeration</td><td>6</td></tr> <tr><td>enumeration</td><td>7</td></tr> <tr><td>enumeration</td><td>8</td></tr> </tbody> </table>	Kind	Value	enumeration	1	enumeration	2	enumeration	3	enumeration	4	enumeration	5	enumeration	6	enumeration	7	enumeration	8
Kind	Value																		
enumeration	1																		
enumeration	2																		
enumeration	3																		
enumeration	4																		
enumeration	5																		
enumeration	6																		
enumeration	7																		
enumeration	8																		

element **Sezione_Altri_Redd_Type/RedditiRitenute**

diagram	
type	m730:Redditi_Ritenute_Type
children	m730:ImportoRedditi m730:ImportoRitenute

complexType **Sezione_Dati_Catastali_Recupero_Patrimonio_Edilizio_Type**

diagram	
children	m730:DatiCatastaliRecuperoPatrimonioEdilizio m730:DatiRegistrazioneAccatastamentoRecuperoPatrimonio_Edilizio

element

Sezione Dati_Catastali_Recupero_Patrimonio_Edilizio_Type/DatiCatastaliRecuperoPatrimonioEdilizio

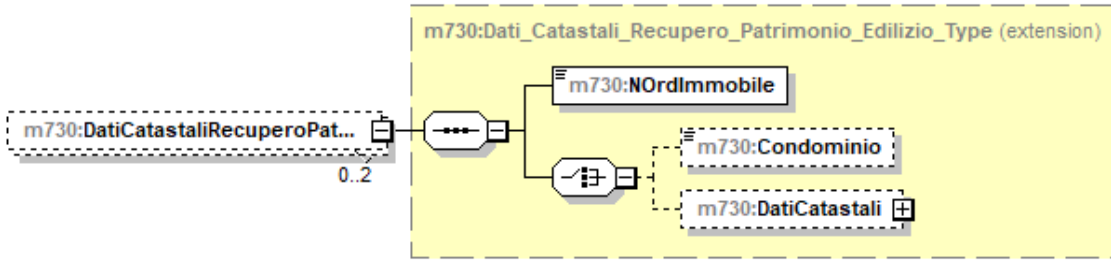
diagram	
type	extension of m730:Dati_Catastali_Recupero_Patrimonio_Edilizio_Type
children	m730:NOrdImmibile m730:Condominio m730:DatiCatastali

element

Sezione Dati_Catastali_Recupero_Patrimonio_Edilizio_Type/DatiRegistrazioneAccatastamentoRecuperoPatrimonio_Edilizio

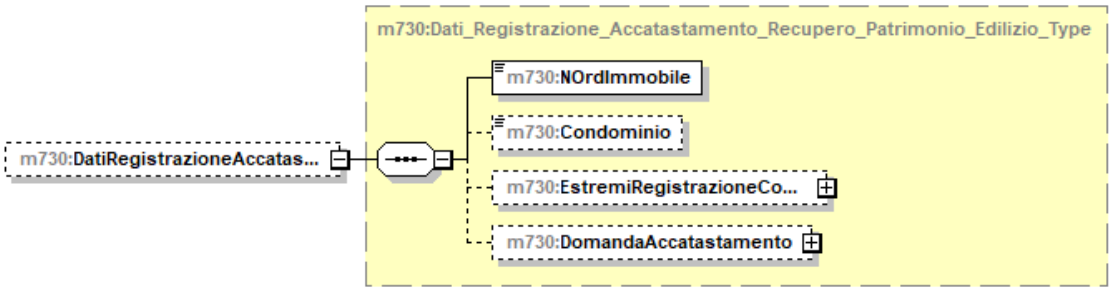
diagram	
type	m730:Dati_Registrazione_Accatastamento_Recupero_Patrimonio_Edilizio_Type
children	m730:NOrdImmibile m730:Condominio m730:EstremiRegistrazioneContratto m730:DomandaAccatastamento

complexType Soggetto_Assistenza_Fiscale_Doc_Type

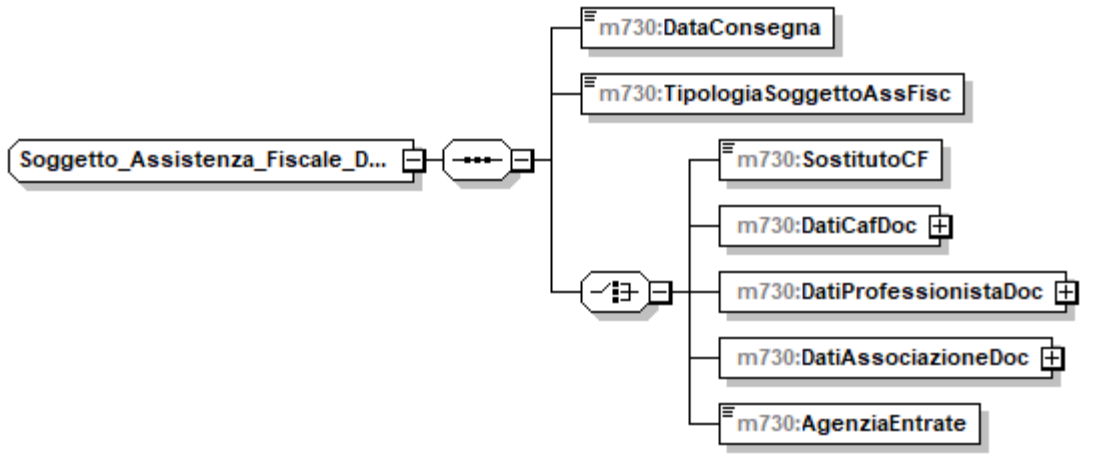
diagram	
children	m730:DataConsegna m730:TipologiaSoggettoAssFisc m730:SostitutoCF m730:DatiCafDoc m730:DatiProfessionistaDoc m730:DatiAssociazioneDoc m730:AgenziaEntrate

element **Soggetto_Assistenza_Fiscale_Doc_Type/DataConsegna**

diagram	
type	DatoDT_Type

element **Soggetto_Assistenza_Fiscale_Doc_Type/TipologiaSoggettoAssFisc**

diagram													
type	m730:Tipologia_Soggetto_Ass_Fisc_Type												
facets	<table border="1"> <thead> <tr> <th>Kind</th> <th>Value</th> </tr> </thead> <tbody> <tr> <td>enumeration</td> <td>1</td> </tr> <tr> <td>enumeration</td> <td>2</td> </tr> <tr> <td>enumeration</td> <td>3</td> </tr> <tr> <td>enumeration</td> <td>4</td> </tr> <tr> <td>enumeration</td> <td>5</td> </tr> </tbody> </table>	Kind	Value	enumeration	1	enumeration	2	enumeration	3	enumeration	4	enumeration	5
Kind	Value												
enumeration	1												
enumeration	2												
enumeration	3												
enumeration	4												
enumeration	5												

element **Soggetto_Assistenza_Fiscale_Doc_Type/SostitutoCF**

diagram	
type	DatoCF_Type

element **Soggetto_Assistenza_Fiscale_Doc_Type/DatiCafDoc**

diagram	<p>The diagram illustrates the structure of the m730:DatiCafDoc element. It is shown as an extension of the m730:Dati_CAF_Type element. The extension is highlighted in a yellow dashed box and includes the following elements:</p> <ul style="list-style-type: none"> m730:CFCaf m730:DenominazioneCaf m730:NumeroAlbo m730:CFResponsabile m730:CognomeResponsabile m730:NomeResponsabile m730:CF Soc Servizi (indicated by a dashed border) m730:IdSedePeriferica (indicated by a dashed border) m730:CasellaAttestazioneCaf (indicated by a dashed border)
type	extension of m730:Dati_CAF_Type

children	m730:CFCaf m730:DenominazioneCaf m730:NumeroAlbo m730:CFResponsabile m730:CognomeResponsabile m730:NomeResponsabile m730:CFSocServizi m730:IdSedePeriferica m730:CasellaAttestazioneCaf
----------	---

element **Soggetto_Assistenza_Fiscale_Doc_Type/DatiCafDoc/CFResponsabile**

diagram	
type	DatoCF_Type

element **Soggetto_Assistenza_Fiscale_Doc_Type/DatiCafDoc/CognomeResponsabile**

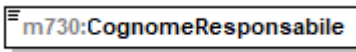
diagram	
type	DatoAN_Type

element **Soggetto_Assistenza_Fiscale_Doc_Type/DatiCafDoc/NomeResponsabile**

diagram	
type	DatoAN_Type

element **Soggetto_Assistenza_Fiscale_Doc_Type/DatiCafDoc/CFSocServizi**

diagram	
type	DatoCN_Type

element **Soggetto_Assistenza_Fiscale_Doc_Type/DatiCafDoc/IdSedePeriferica**

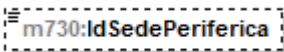
diagram	
type	DatoAN_Type

element **Soggetto_Assistenza_Fiscale_Doc_Type/DatiCafDoc/CasellaAttestazioneCaf**

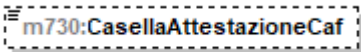
diagram	
type	DatoCB_Type

element **Soggetto_Assistenza_Fiscale_Doc_Type/DatiProfessionistaDoc**

diagram	
type	extension of m730:Dati_Professionista_Type
children	m730:CFProfessionista m730:CognomeProfessionista m730:NomeProfessionista m730:DatiNascitaProfessionista

element **Soggetto_Assistenza_Fiscale_Doc_Type/DatiProfessionistaDoc/DatiNascitaProfessionista**

diagram	
type	m730:Dati_Nascita_PF_Type
children	m730:Sesso m730:DataNascita m730:ComuneNascita m730:ProvinciaNascita

element **Soggetto_Assistenza_Fiscale_Doc_Type/DatiAssociazioneDoc**

diagram	
---------	--

type	extension of m730:Dati_Associazioni_Professionale_Type
children	m730:CFAssociazione m730:DenominazioneAssociazione m730:CFProfessionista m730:CognomeProfessionista m730:NomeProfessionista m730:DatiNascitaProfessionista

element **Soggetto_Assistenza_Fiscale_Doc_Type/DatiAssociazioneDoc/DatiNascitaProfessionista**

diagram	
type	m730:Dati_Nascita_PF_Type
children	m730:Sesso m730:DataNascita m730:ComuneNascita m730:ProvinciaNascita

element **Soggetto_Assistenza_Fiscale_Doc_Type/AgenziaEntrate**

diagram	
type	DatoCB_Type

complexType **Soggetto_Fiscale_730_Type**

diagram	
children	m730:CodiceFiscale m730:Email m730:Telefono m730:Cellulare

element **Soggetto_Fiscale_730_Type/CodiceFiscale**

diagram	
type	DatoCF_Type

element **Soggetto_Fiscale_730_Type/Email**

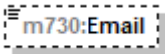
diagram	
type	DatoEM_Type

element **Soggetto_Fiscale_730_Type/Telefono**

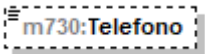
diagram	
type	DatoAN_Type

element **Soggetto_Fiscale_730_Type/Cellulare**

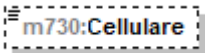
diagram	
type	DatoAN_Type

complexType **Soglie_Esenzione_Type**

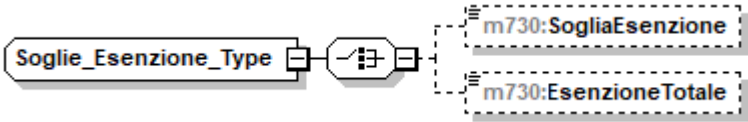
diagram	
children	m730:SogliaEsenzione m730:EsenzioneTotale

element **Soglie_Esenzione_Type/SogliaEsenzione**

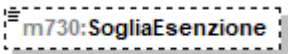
diagram	
type	DatoNP_Type

element **Soglie_Esenzione_Type/EsenzioneTotale**

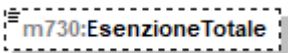
diagram							
type	restriction of DatoN1_Type						
facets	<table border="1"> <thead> <tr> <th>Kind</th> <th>Value</th> </tr> </thead> <tbody> <tr> <td>enumeration</td> <td>1</td> </tr> <tr> <td>enumeration</td> <td>2</td> </tr> </tbody> </table>	Kind	Value	enumeration	1	enumeration	2
Kind	Value						
enumeration	1						
enumeration	2						

complexType **Sostituto_Type**

diagram	
children	m730:CodiceFiscale m730:DatiAnagraficiPF m730:DenominazionePNF m730:Residenza m730:Fax m730:CodiceSede

element **Sostituto_Type/CodiceFiscale**

diagram	
type	DatoCF_Type

element **Sostituto_Type/DatiAnagraficiPF**

diagram	
children	m730:Cognome m730:Nome

element **Sostituto_Type/DatiAnagraficiPF/Cognome**

diagram	
type	DatoAN_Type

element **Sostituto_Type/DatiAnagraficiPF/Nome**

diagram	
type	DatoAN_Type

element **Sostituto_Type/DenominazionePNF**

diagram	
type	DatoAN_Type

element **Sostituto_Type/Residenza**

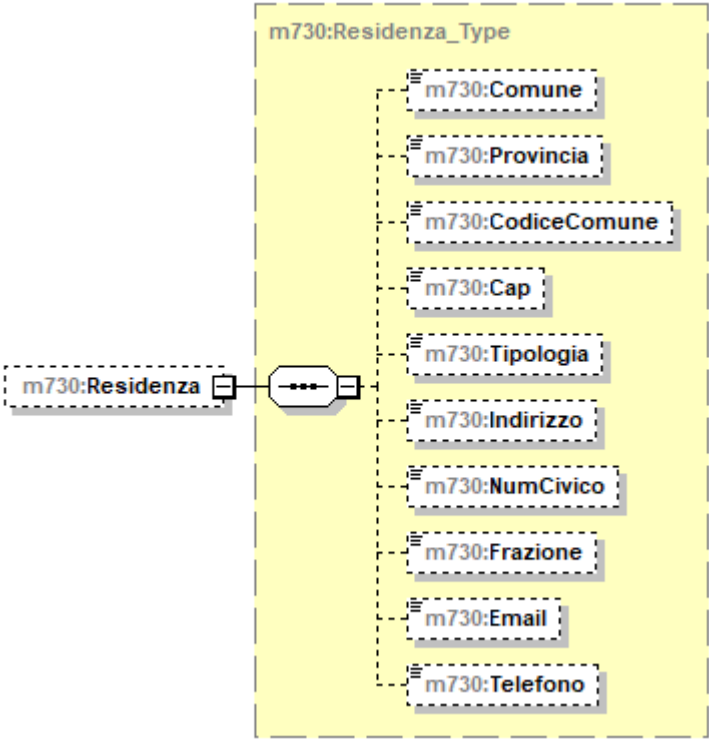
diagram	
type	m730:Residenza_Type
children	m730:Comune m730:Provincia m730:CodiceComune m730:Cap m730:Tipologia m730:Indirizzo m730:NumCivico m730:Frazione m730:Email m730:Telefono

element **Sostituto_Type/Fax**

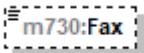
diagram	
type	DatoAN_Type

element **Sostituto_Type/CodiceSede**

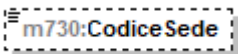
diagram	
type	DatoAN_Type

complexType **Spese_Arredo_Giovani_Coppie_Type**

diagram	
children	m730:Meno35Anni m730:Importo

element **Spese_Arredo_Giovani_Coppie_Type/Meno35Anni**

diagram	
type	DatoCB_Type

element **Spese_Arredo_Giovani_Coppie_Type/Importo**

diagram	
type	DatoNP_Type

complexType **Spese_Arredo_Type**

diagram	
children	m730:NumeroRata m730:Importo

element **Spese_Arredo_Type/NumeroRata**

diagram																							
type	restriction of DatoNP_Type																						
facets	<table border="1"> <thead> <tr> <th>Kind</th> <th>Value</th> </tr> </thead> <tbody> <tr><td>enumeration</td><td>1</td></tr> <tr><td>enumeration</td><td>2</td></tr> <tr><td>enumeration</td><td>3</td></tr> <tr><td>enumeration</td><td>4</td></tr> <tr><td>enumeration</td><td>5</td></tr> <tr><td>enumeration</td><td>6</td></tr> <tr><td>enumeration</td><td>7</td></tr> <tr><td>enumeration</td><td>8</td></tr> <tr><td>enumeration</td><td>9</td></tr> <tr><td>enumeration</td><td>10</td></tr> </tbody> </table>	Kind	Value	enumeration	1	enumeration	2	enumeration	3	enumeration	4	enumeration	5	enumeration	6	enumeration	7	enumeration	8	enumeration	9	enumeration	10
Kind	Value																						
enumeration	1																						
enumeration	2																						
enumeration	3																						
enumeration	4																						
enumeration	5																						
enumeration	6																						
enumeration	7																						
enumeration	8																						
enumeration	9																						
enumeration	10																						

element **Spese_Arredo_Type/Importo**

diagram	
type	DatoNP_Type

complexType **Spese_Laurea_Ricarica_Type**

diagram	
children	m730:Codice m730:Anno m730:Importo m730:Percentuale m730:Rata

element **Spese_Laurea_Ricarica_Type/Codice**

diagram													
type	restriction of DatoNP_Type												
facets	<table border="1"> <thead> <tr> <th>Kind</th> <th>Value</th> </tr> </thead> <tbody> <tr> <td>enumeration</td> <td>1</td> </tr> <tr> <td>enumeration</td> <td>2</td> </tr> <tr> <td>enumeration</td> <td>3</td> </tr> <tr> <td>enumeration</td> <td>4</td> </tr> <tr> <td>enumeration</td> <td>5</td> </tr> </tbody> </table>	Kind	Value	enumeration	1	enumeration	2	enumeration	3	enumeration	4	enumeration	5
Kind	Value												
enumeration	1												
enumeration	2												
enumeration	3												
enumeration	4												
enumeration	5												

element **Spese_Laurea_Ricarica_Type/Anno**

diagram	
type	DatoDA_Type

element **Spese_Laurea_Ricarica_Type/Importo**

diagram	
type	DatoNP_Type

element **Spese_Laurea_Ricarica_Type/Percentuale**

diagram							
type	restriction of DatoNP_Type						
facets	<table border="1"> <thead> <tr> <th>Kind</th> <th>Value</th> </tr> </thead> <tbody> <tr> <td>enumeration</td> <td>1</td> </tr> <tr> <td>enumeration</td> <td>2</td> </tr> </tbody> </table>	Kind	Value	enumeration	1	enumeration	2
Kind	Value						
enumeration	1						
enumeration	2						

element **Spese_Laurea_Ricarica_Type/Rata**

diagram							
type	restriction of DatoNP_Type						
facets	<table border="1"> <thead> <tr> <th>Kind</th> <th>Value</th> </tr> </thead> <tbody> <tr> <td>enumeration</td> <td>1</td> </tr> <tr> <td>enumeration</td> <td>2</td> </tr> </tbody> </table>	Kind	Value	enumeration	1	enumeration	2
Kind	Value						
enumeration	1						
enumeration	2						

complexType **Spese_Leasing_Type**

diagram	
children	m730:DataStipula m730:NumeroAnno m730:Canone m730:PrezzoRiscatto

element **Spese_Leasing_Type/DataStipula**

diagram	
type	DatoDT_Type

element **Spese_Leasing_Type/NumeroAnno**

diagram													
type	restriction of DatoNP_Type												
facets	<table border="1"> <thead> <tr> <th>Kind</th> <th>Value</th> </tr> </thead> <tbody> <tr> <td>enumeration</td> <td>4</td> </tr> <tr> <td>enumeration</td> <td>5</td> </tr> <tr> <td>enumeration</td> <td>6</td> </tr> <tr> <td>enumeration</td> <td>7</td> </tr> <tr> <td>enumeration</td> <td>8</td> </tr> </tbody> </table>	Kind	Value	enumeration	4	enumeration	5	enumeration	6	enumeration	7	enumeration	8
Kind	Value												
enumeration	4												
enumeration	5												
enumeration	6												
enumeration	7												
enumeration	8												

element **Spese_Leasing_Type/Canone**

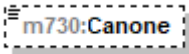
diagram	
type	restriction of DatoNP_Type

element **Spese_Leasing_Type/PrezzoRiscatto**

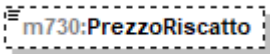
diagram	
type	restriction of DatoNP_Type

complexType **Spese_Rateizzate_Anni_Precedenti_Type**

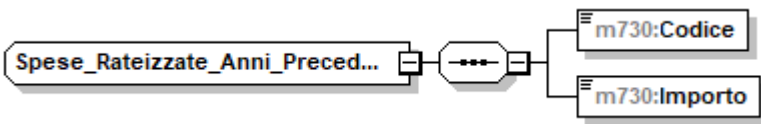
diagram	
children	m730:Codice m730:Importo

element **Spese_Rateizzate_Anni_Precedenti_Type/Codice**

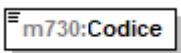
diagram									
type	m730:Codice Spese_Rateizzate_Anni_Precedenti_Type								
facets	<table border="1"> <thead> <tr> <th>Kind</th> <th>Value</th> </tr> </thead> <tbody> <tr> <td>enumeration</td> <td>2</td> </tr> <tr> <td>enumeration</td> <td>3</td> </tr> <tr> <td>enumeration</td> <td>4</td> </tr> </tbody> </table>	Kind	Value	enumeration	2	enumeration	3	enumeration	4
Kind	Value								
enumeration	2								
enumeration	3								
enumeration	4								

element **Spese_Rateizzate_Anni_Precedenti_Type/Importo**

diagram	
type	DatoNP_Type

complexType **Spese_Rateizzate_Type**

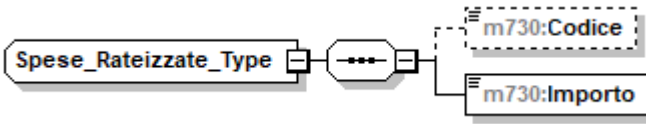
diagram	
children	m730:Codice m730:Importo

element **Spese_Rateizzate_Type/Codice**

diagram											
type	m730:Codice Spese_Rateizzate_Type										
facets	<table border="1"> <thead> <tr> <th>Kind</th> <th>Value</th> </tr> </thead> <tbody> <tr> <td>enumeration</td> <td>1</td> </tr> <tr> <td>enumeration</td> <td>2</td> </tr> <tr> <td>enumeration</td> <td>3</td> </tr> <tr> <td>enumeration</td> <td>4</td> </tr> </tbody> </table>	Kind	Value	enumeration	1	enumeration	2	enumeration	3	enumeration	4
Kind	Value										
enumeration	1										
enumeration	2										
enumeration	3										
enumeration	4										

element **Spese_Rateizzate_Type/Importo**

diagram	
type	DatoNP_Type

complexType **Tassazione_Separata_Type**

diagram	
children	m730:Opzione m730:Anno m730:RedditoRitenute

element **Tassazione_Separata_Type/Opzione**

diagram	
type	DatoCB_Type

element **Tassazione_Separata_Type/Anno**

diagram	
type	DatoDA_Type

element **Tassazione_Separata_Type/RedditoRitenute**

diagram	<p>The diagram shows a dashed box labeled 'm730:RedditoRitenute' connected to a solid box labeled 'm730:Redditi_Ritenute_Type'. Inside the solid box, there are two dashed boxes: 'm730:ImportoRedditi' and 'm730:ImportoRitenute'.</p>
type	m730:Redditi_Ritenute_Type
children	m730:ImportoRedditi m730:ImportoRitenute

complexType **Terreno_Type**

diagram	<p>The diagram shows a solid box labeled 'Terreno_Type' connected to a complex type box. This complex type box contains several dashed boxes representing child elements: 'm730:RedDominicale', 'm730:Titolo', 'm730:RedAgrario', 'm730:GiorniPossesso', 'm730:PercPossesso', 'm730:CanoneVincolistico', 'm730:CasiParticolari', 'm730:CasellaContinuazione', 'm730:CasellalmuNonDovuta', and 'm730:CasellaColtivatoreDiretto'.</p>
children	m730:RedDominicale m730:Titolo m730:RedAgrario m730:GiorniPossesso m730:PercPossesso m730:CanoneVincolistico m730:CasiParticolari m730:CasellaContinuazione m730:CasellalmuNonDovuta m730:CasellaColtivatoreDiretto

element **Terreno_Type/RedDominicale**

diagram	<p>The diagram shows a dashed box labeled 'm730:RedDominicale'.</p>
type	DatoNP_Type

element **Terreno_Type/Titolo**

diagram	<p>The diagram shows a solid box labeled 'm730:Titolo'.</p>
---------	---

type	m730:Titolo Terreno Type	
facets	Kind	Value
	enumeration	1
	enumeration	2
	enumeration	3
	enumeration	4
	enumeration	5
	enumeration	6
	enumeration	7
	enumeration	10

element **Terreno_Type/RedAgrario**

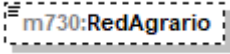
diagram		
type	DatoNP Type	

element **Terreno_Type/GiorniPossesso**

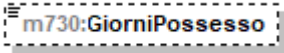
diagram		
type	DatoGA Type	

element **Terreno_Type/PercPossesso**

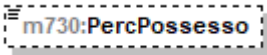
diagram		
type	DatoPC Type	

element **Terreno_Type/CanoneVincolistico**

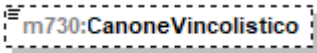
diagram		
type	DatoNP Type	

element **Terreno_Type/CasiParticolari**

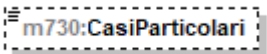
diagram		
type	m730:Casi Particolari Terreni Type	
facets	Kind	Value
	enumeration	2
	enumeration	3
	enumeration	4
	enumeration	6

element **Terreno_Type/CasellaContinuazione**

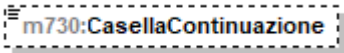
diagram	
type	DatoCB_Type

element **Terreno_Type/CasellalmuNonDovuta**

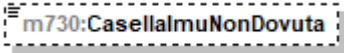
diagram	
type	DatoCB_Type

element **Terreno_Type/CasellaColtivatoreDiretto**

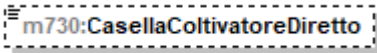
diagram	
type	DatoCB_Type

complexType **Ulteriori_Dati_Type**

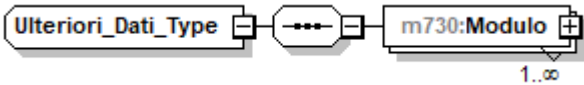
diagram	
children	m730:Modulo

element **Ulteriori_Dati_Type/Modulo**

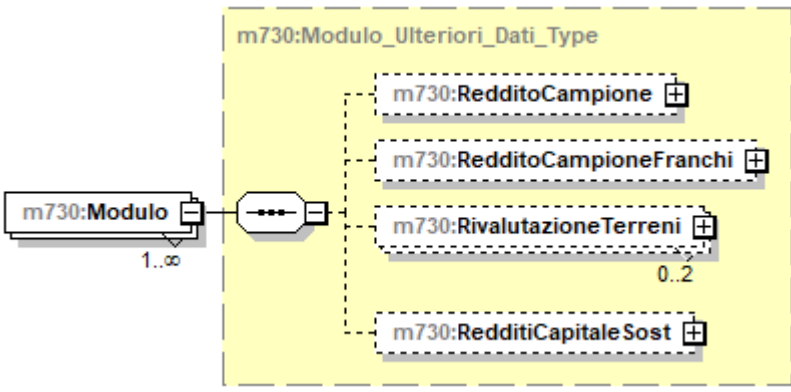
diagram	
type	m730:Modulo Ulteriori_Dati_Type
children	m730:RedditoCampione m730:RedditoCampioneFranchi m730:RivalutazioneTerreni m730:RedditiCapitaleSost

complexType **Versamenti_F24_Type**

diagram



children

[m730:F24DebitoIrpef](#)
[m730:F24DebitoCodRegione](#)
[m730:F24DebitoAddReg](#)
[m730:F24DebitoCodComune](#)
[m730:F24DebitoAddCom](#)
[m730:F24DebitoPrimaRataAcclrpef](#)
[m730:F24DebitoAccontoTassSep](#)
[m730:F24DebitoCodComuneAcconto](#)
[m730:F24DebitoAccontoAddCom](#)
[m730:F24DebitoImpostaSost](#)
[m730:F24DebitoCedolare](#)
[m730:F24DebitoPrimaRataAccCedolare](#)
[m730:F24DebitoCodRegioneConiuge](#)
[m730:F24DebitoAddRegConiuge](#)
[m730:F24DebitoCodComuneConiuge](#)
[m730:F24DebitoAddComConiuge](#)
[m730:F24DebitoCodComuneAccCedolare](#)
[m730:F24DebitoAccontoAddComConiuge](#)
[m730:F24DebitoSecondaRataAcclrpef](#)
[m730:F24DebitoSecondaRataAccCedolare](#)

element **Versamenti_F24_Type/F24DebitoIrpef**

diagram	
type	DatoNP_Type

element **Versamenti_F24_Type/F24DebitoCodRegione**

diagram																																													
type	Codice Regione_Type																																												
facets	<table border="1"> <thead> <tr> <th>Kind</th> <th>Value</th> </tr> </thead> <tbody> <tr><td>enumeration</td><td>1</td></tr> <tr><td>enumeration</td><td>2</td></tr> <tr><td>enumeration</td><td>3</td></tr> <tr><td>enumeration</td><td>4</td></tr> <tr><td>enumeration</td><td>5</td></tr> <tr><td>enumeration</td><td>6</td></tr> <tr><td>enumeration</td><td>7</td></tr> <tr><td>enumeration</td><td>8</td></tr> <tr><td>enumeration</td><td>9</td></tr> <tr><td>enumeration</td><td>10</td></tr> <tr><td>enumeration</td><td>11</td></tr> <tr><td>enumeration</td><td>12</td></tr> <tr><td>enumeration</td><td>13</td></tr> <tr><td>enumeration</td><td>14</td></tr> <tr><td>enumeration</td><td>15</td></tr> <tr><td>enumeration</td><td>16</td></tr> <tr><td>enumeration</td><td>17</td></tr> <tr><td>enumeration</td><td>18</td></tr> <tr><td>enumeration</td><td>19</td></tr> <tr><td>enumeration</td><td>20</td></tr> <tr><td>enumeration</td><td>21</td></tr> </tbody> </table>	Kind	Value	enumeration	1	enumeration	2	enumeration	3	enumeration	4	enumeration	5	enumeration	6	enumeration	7	enumeration	8	enumeration	9	enumeration	10	enumeration	11	enumeration	12	enumeration	13	enumeration	14	enumeration	15	enumeration	16	enumeration	17	enumeration	18	enumeration	19	enumeration	20	enumeration	21
Kind	Value																																												
enumeration	1																																												
enumeration	2																																												
enumeration	3																																												
enumeration	4																																												
enumeration	5																																												
enumeration	6																																												
enumeration	7																																												
enumeration	8																																												
enumeration	9																																												
enumeration	10																																												
enumeration	11																																												
enumeration	12																																												
enumeration	13																																												
enumeration	14																																												
enumeration	15																																												
enumeration	16																																												
enumeration	17																																												
enumeration	18																																												
enumeration	19																																												
enumeration	20																																												
enumeration	21																																												

element **Versamenti_F24_Type/F24DebitoAddReg**

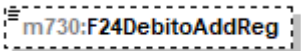
diagram	
type	DatoNP_Type

element **Versamenti_F24_Type/F24DebitoCodComune**

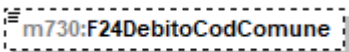
diagram	
type	DatoAN_Type

element **Versamenti_F24_Type/F24DebitoAddCom**

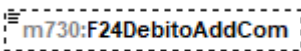
diagram	
type	DatoNP_Type

element **Versamenti_F24_Type/F24DebitoPrimaRataAcclrpef**

diagram	 m730:F24DebitoPrimaRataAcclrpef
type	DatoNP_Type

element **Versamenti_F24_Type/F24DebitoAccontoTassSep**

diagram	 m730:F24DebitoAccontoTass Sep
type	DatoNP_Type

element **Versamenti_F24_Type/F24DebitoCodComuneAcconto**

diagram	 m730:F24DebitoCodComuneAcc...
type	DatoAN_Type

element **Versamenti_F24_Type/F24DebitoAccontoAddCom**

diagram	 m730:F24DebitoAccontoAddCom
type	DatoNP_Type

element **Versamenti_F24_Type/F24DebitoImpostaSost**

diagram	 m730:F24DebitoImpostaSost
type	DatoNP_Type

element **Versamenti_F24_Type/F24DebitoCedolare**

diagram	 m730:F24DebitoCedolare
type	DatoNP_Type

element **Versamenti_F24_Type/F24DebitoPrimaRataAccCedolare**

diagram	 m730:F24DebitoPrimaRataAccCe...
type	DatoNP_Type

element **Versamenti_F24_Type/F24DebitoCodRegioneConiuge**

diagram	 m730:F24DebitoCodRegioneConi...																																												
type	Codice Regione Type																																												
facets	<table border="1"> <thead> <tr> <th>Kind</th> <th>Value</th> </tr> </thead> <tbody> <tr><td>enumeration</td><td>1</td></tr> <tr><td>enumeration</td><td>2</td></tr> <tr><td>enumeration</td><td>3</td></tr> <tr><td>enumeration</td><td>4</td></tr> <tr><td>enumeration</td><td>5</td></tr> <tr><td>enumeration</td><td>6</td></tr> <tr><td>enumeration</td><td>7</td></tr> <tr><td>enumeration</td><td>8</td></tr> <tr><td>enumeration</td><td>9</td></tr> <tr><td>enumeration</td><td>10</td></tr> <tr><td>enumeration</td><td>11</td></tr> <tr><td>enumeration</td><td>12</td></tr> <tr><td>enumeration</td><td>13</td></tr> <tr><td>enumeration</td><td>14</td></tr> <tr><td>enumeration</td><td>15</td></tr> <tr><td>enumeration</td><td>16</td></tr> <tr><td>enumeration</td><td>17</td></tr> <tr><td>enumeration</td><td>18</td></tr> <tr><td>enumeration</td><td>19</td></tr> <tr><td>enumeration</td><td>20</td></tr> <tr><td>enumeration</td><td>21</td></tr> </tbody> </table>	Kind	Value	enumeration	1	enumeration	2	enumeration	3	enumeration	4	enumeration	5	enumeration	6	enumeration	7	enumeration	8	enumeration	9	enumeration	10	enumeration	11	enumeration	12	enumeration	13	enumeration	14	enumeration	15	enumeration	16	enumeration	17	enumeration	18	enumeration	19	enumeration	20	enumeration	21
Kind	Value																																												
enumeration	1																																												
enumeration	2																																												
enumeration	3																																												
enumeration	4																																												
enumeration	5																																												
enumeration	6																																												
enumeration	7																																												
enumeration	8																																												
enumeration	9																																												
enumeration	10																																												
enumeration	11																																												
enumeration	12																																												
enumeration	13																																												
enumeration	14																																												
enumeration	15																																												
enumeration	16																																												
enumeration	17																																												
enumeration	18																																												
enumeration	19																																												
enumeration	20																																												
enumeration	21																																												

element **Versamenti_F24_Type/F24DebitoAddRegConiuge**

diagram	 m730:F24DebitoAddRegConiuge
type	DatoNP Type

element **Versamenti_F24_Type/F24DebitoCodComuneConiuge**

diagram	 m730:F24DebitoCodComuneCon...
type	DatoAN Type

element **Versamenti_F24_Type/F24DebitoAddComConiuge**

diagram	 m730:F24DebitoAddComConiuge
type	DatoNP Type

element **Versamenti_F24_Type/F24DebitoCodComuneAccontoConiuge**

diagram	 m730:F24DebitoCodComuneAcc...
type	DatoAN Type

element **Versamenti_F24_Type/F24DebitoAccontoAddComConiuge**

diagram	
type	DatoNP_Type

element **Versamenti_F24_Type/F24DebitoSecondaRataAcclrpef**

diagram	
type	DatoNP_Type

element **Versamenti_F24_Type/F24DebitoSecondaRataAccCedolare**

diagram	
type	DatoNP_Type

element **Intestazione**

diagram	
type	m730:Intestazione_730_Type
children	m730:TipoFornitore m730:SpazioUtente

complexType **Intestazione_730_Type**

diagram	
children	m730:TipoFornitore m730:SpazioUtente

element **Intestazione_730_Type/TipoFornitore**

diagram	
---------	--

type	restriction of DatoAN_Type														
facets	<table border="1"> <thead> <tr> <th>Kind</th> <th>Value</th> </tr> </thead> <tbody> <tr> <td>enumeration</td> <td>1</td> </tr> <tr> <td>enumeration</td> <td>2</td> </tr> <tr> <td>enumeration</td> <td>3</td> </tr> <tr> <td>enumeration</td> <td>5</td> </tr> <tr> <td>enumeration</td> <td>6</td> </tr> <tr> <td>enumeration</td> <td>10</td> </tr> </tbody> </table>	Kind	Value	enumeration	1	enumeration	2	enumeration	3	enumeration	5	enumeration	6	enumeration	10
Kind	Value														
enumeration	1														
enumeration	2														
enumeration	3														
enumeration	5														
enumeration	6														
enumeration	10														

element **Intestazione_730_Type/SpazioUtente**

diagram	
type	DatoAN_Type

element **Fornitura**

diagram	
---------	--

element **Messaggio**

diagram	
children	tm:Intestazione tm:Contenuto

element **Messaggio/Intestazione**

diagram	
type	tm:IntestazioneType
children	tm:CodiceFiscaleFornitore tm:SpazioServizioTelematico

element **Messaggio/Contenuto**

diagram					
type	tm:ContenutoType				
children	tm:Fornitura				
attributes	Name CodiceFornitura	Type derived by: xs:string	Use	Default	Fixed

complexType **ContenutoType**

diagram					
children	tm:Fornitura				
attributes	Name CodiceFornitura	Type derived by: xs:string	Use	Default	Fixed

attribute **ContenutoType/@CodiceFornitura**

type	restriction of xs:string
------	--------------------------

complexType **IntestazioneType**

diagram					
children	tm:CodiceFiscaleFornitore tm:SpazioServizioTelematico				

element **IntestazioneType/CodiceFiscaleFornitore**

diagram	
type	restriction of xs:string

element **IntestazioneType/SpazioServizioTelematico**

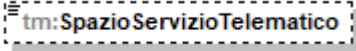
diagram	
type	restriction of xs:string

simpleType **Anno_Anticipazione_Fondo_Pensione_Type**

type	restriction of DatoNP_Type																																				
facets	<table border="1"> <thead> <tr> <th>Kind</th> <th>Value</th> </tr> </thead> <tbody> <tr><td>enumeration</td><td>2007</td></tr> <tr><td>enumeration</td><td>2008</td></tr> <tr><td>enumeration</td><td>2009</td></tr> <tr><td>enumeration</td><td>2010</td></tr> <tr><td>enumeration</td><td>2011</td></tr> <tr><td>enumeration</td><td>2012</td></tr> <tr><td>enumeration</td><td>2013</td></tr> <tr><td>enumeration</td><td>2014</td></tr> <tr><td>enumeration</td><td>2015</td></tr> <tr><td>enumeration</td><td>2016</td></tr> <tr><td>enumeration</td><td>2017</td></tr> <tr><td>enumeration</td><td>2018</td></tr> <tr><td>enumeration</td><td>2019</td></tr> <tr><td>enumeration</td><td>2020</td></tr> <tr><td>enumeration</td><td>2021</td></tr> <tr><td>enumeration</td><td>2022</td></tr> <tr><td>enumeration</td><td>2023</td></tr> </tbody> </table>	Kind	Value	enumeration	2007	enumeration	2008	enumeration	2009	enumeration	2010	enumeration	2011	enumeration	2012	enumeration	2013	enumeration	2014	enumeration	2015	enumeration	2016	enumeration	2017	enumeration	2018	enumeration	2019	enumeration	2020	enumeration	2021	enumeration	2022	enumeration	2023
Kind	Value																																				
enumeration	2007																																				
enumeration	2008																																				
enumeration	2009																																				
enumeration	2010																																				
enumeration	2011																																				
enumeration	2012																																				
enumeration	2013																																				
enumeration	2014																																				
enumeration	2015																																				
enumeration	2016																																				
enumeration	2017																																				
enumeration	2018																																				
enumeration	2019																																				
enumeration	2020																																				
enumeration	2021																																				
enumeration	2022																																				
enumeration	2023																																				

simpleType **Anno_Recupero_Patrimonio_Edilizio_Type**

type	restriction of DatoNP_Type																						
facets	<table border="1"> <thead> <tr> <th>Kind</th> <th>Value</th> </tr> </thead> <tbody> <tr><td>enumeration</td><td>2014</td></tr> <tr><td>enumeration</td><td>2015</td></tr> <tr><td>enumeration</td><td>2016</td></tr> <tr><td>enumeration</td><td>2017</td></tr> <tr><td>enumeration</td><td>2018</td></tr> <tr><td>enumeration</td><td>2019</td></tr> <tr><td>enumeration</td><td>2020</td></tr> <tr><td>enumeration</td><td>2021</td></tr> <tr><td>enumeration</td><td>2022</td></tr> <tr><td>enumeration</td><td>2023</td></tr> </tbody> </table>	Kind	Value	enumeration	2014	enumeration	2015	enumeration	2016	enumeration	2017	enumeration	2018	enumeration	2019	enumeration	2020	enumeration	2021	enumeration	2022	enumeration	2023
Kind	Value																						
enumeration	2014																						
enumeration	2015																						
enumeration	2016																						
enumeration	2017																						
enumeration	2018																						
enumeration	2019																						
enumeration	2020																						
enumeration	2021																						
enumeration	2022																						
enumeration	2023																						

simpleType **Anno_Risparmio_Energetico_Type**

type	restriction of DatoNP_Type										
facets	<table border="1"> <thead> <tr> <th>Kind</th> <th>Value</th> </tr> </thead> <tbody> <tr><td>enumeration</td><td>2008</td></tr> <tr><td>enumeration</td><td>2014</td></tr> <tr><td>enumeration</td><td>2015</td></tr> <tr><td>enumeration</td><td>2016</td></tr> </tbody> </table>	Kind	Value	enumeration	2008	enumeration	2014	enumeration	2015	enumeration	2016
Kind	Value										
enumeration	2008										
enumeration	2014										
enumeration	2015										
enumeration	2016										

	enumeration	2017
	enumeration	2018
	enumeration	2019
	enumeration	2020
	enumeration	2021
	enumeration	2022
	enumeration	2023

simpleType Casi_Particolari_Fabbricato_Type

type	restriction of DatoN1_Type	
facets	Kind	Value
	enumeration	1
	enumeration	3
	enumeration	4
	enumeration	5
	enumeration	6
	enumeration	7
	enumeration	8

simpleType Casi_Particolari_Risp_Ener_Type

type	restriction of DatoN1_Type	
facets	Kind	Value
	enumeration	1
	enumeration	2
	enumeration	3

simpleType Casi_Particolari_Terreni_Type

type	restriction of DatoN1_Type	
facets	Kind	Value
	enumeration	2
	enumeration	3
	enumeration	4
	enumeration	6

simpleType Codice_Altre_Detrazioni_Type

type	restriction of DatoNP_Type	
facets	Kind	Value
	enumeration	1
	enumeration	2

simpleType Codice_Altre_Spese_Type

type	restriction of DatoNP_Type	
facets	Kind	Value
	enumeration	8
	enumeration	9
	enumeration	10
	enumeration	11
	enumeration	12
	enumeration	13
	enumeration	14
	enumeration	15
	enumeration	16
	enumeration	17

	enumeration	18
	enumeration	20
	enumeration	21
	enumeration	22
	enumeration	24
	enumeration	25
	enumeration	26
	enumeration	27
	enumeration	28
	enumeration	29
	enumeration	30
	enumeration	31
	enumeration	32
	enumeration	33
	enumeration	35
	enumeration	36
	enumeration	38
	enumeration	39
	enumeration	40
	enumeration	43
	enumeration	44
	enumeration	45
	enumeration	46
	enumeration	47
	enumeration	61
	enumeration	62
	enumeration	71
	enumeration	76
	enumeration	81
	enumeration	99

simpleType Codice_Altri_Oneri_Type

type	restriction of DatoNP_Type	
facets	Kind	Value
	enumeration	6
	enumeration	7
	enumeration	8
	enumeration	9
	enumeration	12
	enumeration	13
	enumeration	21

simpleType Codice_Canone_Type

type	restriction of DatoN1_Type	
facets	Kind	Value
	enumeration	1
	enumeration	2
	enumeration	3
	enumeration	4

simpleType Codice_Evento_Eccezionale_Type

type	restriction of DatoNP_Type	
facets	Kind	Value
	enumeration	1
	enumeration	2
	enumeration	3
	enumeration	99

simpleType **Codice_Spese_Rateizzate_Anni_Precedenti_Type**

type	restriction of DatoNP_Type								
facets	<table><thead><tr><th>Kind</th><th>Value</th></tr></thead><tbody><tr><td>enumeration</td><td>2</td></tr><tr><td>enumeration</td><td>3</td></tr><tr><td>enumeration</td><td>4</td></tr></tbody></table>	Kind	Value	enumeration	2	enumeration	3	enumeration	4
Kind	Value								
enumeration	2								
enumeration	3								
enumeration	4								

simpleType **Codice_Spese_Rateizzate_Type**

type	restriction of DatoNP_Type										
facets	<table><thead><tr><th>Kind</th><th>Value</th></tr></thead><tbody><tr><td>enumeration</td><td>1</td></tr><tr><td>enumeration</td><td>2</td></tr><tr><td>enumeration</td><td>3</td></tr><tr><td>enumeration</td><td>4</td></tr></tbody></table>	Kind	Value	enumeration	1	enumeration	2	enumeration	3	enumeration	4
Kind	Value										
enumeration	1										
enumeration	2										
enumeration	3										
enumeration	4										

simpleType **Fabbricato_Agev_Numero_Rigo_Type**

type	restriction of DatoNP_Type																						
facets	<table><thead><tr><th>Kind</th><th>Value</th></tr></thead><tbody><tr><td>enumeration</td><td>1</td></tr><tr><td>enumeration</td><td>2</td></tr><tr><td>enumeration</td><td>3</td></tr><tr><td>enumeration</td><td>4</td></tr><tr><td>enumeration</td><td>5</td></tr><tr><td>enumeration</td><td>6</td></tr><tr><td>enumeration</td><td>7</td></tr><tr><td>enumeration</td><td>8</td></tr><tr><td>enumeration</td><td>9</td></tr><tr><td>enumeration</td><td>10</td></tr></tbody></table>	Kind	Value	enumeration	1	enumeration	2	enumeration	3	enumeration	4	enumeration	5	enumeration	6	enumeration	7	enumeration	8	enumeration	9	enumeration	10
Kind	Value																						
enumeration	1																						
enumeration	2																						
enumeration	3																						
enumeration	4																						
enumeration	5																						
enumeration	6																						
enumeration	7																						
enumeration	8																						
enumeration	9																						
enumeration	10																						

simpleType **Indeterminato_Determinato_Type**

type	restriction of DatoN1_Type						
facets	<table><thead><tr><th>Kind</th><th>Value</th></tr></thead><tbody><tr><td>enumeration</td><td>1</td></tr><tr><td>enumeration</td><td>2</td></tr></tbody></table>	Kind	Value	enumeration	1	enumeration	2
Kind	Value						
enumeration	1						
enumeration	2						

simpleType **Integrativo_Type**

type	restriction of DatoN1_Type								
facets	<table><thead><tr><th>Kind</th><th>Value</th></tr></thead><tbody><tr><td>enumeration</td><td>1</td></tr><tr><td>enumeration</td><td>2</td></tr><tr><td>enumeration</td><td>3</td></tr></tbody></table>	Kind	Value	enumeration	1	enumeration	2	enumeration	3
Kind	Value								
enumeration	1								
enumeration	2								
enumeration	3								

simpleType **Mesi_Type**

type	restriction of DatoNP_Type																
facets	<table><thead><tr><th>Kind</th><th>Value</th></tr></thead><tbody><tr><td>enumeration</td><td>1</td></tr><tr><td>enumeration</td><td>2</td></tr><tr><td>enumeration</td><td>3</td></tr><tr><td>enumeration</td><td>4</td></tr><tr><td>enumeration</td><td>5</td></tr><tr><td>enumeration</td><td>6</td></tr><tr><td>enumeration</td><td>7</td></tr></tbody></table>	Kind	Value	enumeration	1	enumeration	2	enumeration	3	enumeration	4	enumeration	5	enumeration	6	enumeration	7
Kind	Value																
enumeration	1																
enumeration	2																
enumeration	3																
enumeration	4																
enumeration	5																
enumeration	6																
enumeration	7																

	enumeration 8
	enumeration 9
	enumeration 10
	enumeration 11
	enumeration 12

simpleType **Numero_Rata_Risparmio_Energetico_Type**

type	restriction of DatoNP_Type																						
facets	<table border="1"> <thead> <tr> <th>Kind</th> <th>Value</th> </tr> </thead> <tbody> <tr><td>enumeration</td><td>1</td></tr> <tr><td>enumeration</td><td>2</td></tr> <tr><td>enumeration</td><td>3</td></tr> <tr><td>enumeration</td><td>4</td></tr> <tr><td>enumeration</td><td>5</td></tr> <tr><td>enumeration</td><td>6</td></tr> <tr><td>enumeration</td><td>7</td></tr> <tr><td>enumeration</td><td>8</td></tr> <tr><td>enumeration</td><td>9</td></tr> <tr><td>enumeration</td><td>10</td></tr> </tbody> </table>	Kind	Value	enumeration	1	enumeration	2	enumeration	3	enumeration	4	enumeration	5	enumeration	6	enumeration	7	enumeration	8	enumeration	9	enumeration	10
Kind	Value																						
enumeration	1																						
enumeration	2																						
enumeration	3																						
enumeration	4																						
enumeration	5																						
enumeration	6																						
enumeration	7																						
enumeration	8																						
enumeration	9																						
enumeration	10																						

simpleType **Periodo_Spese_Ristrutturazione_Type**

type	restriction of DatoNP_Type																																										
facets	<table border="1"> <thead> <tr> <th>Kind</th> <th>Value</th> </tr> </thead> <tbody> <tr><td>enumeration</td><td>2</td></tr> <tr><td>enumeration</td><td>3</td></tr> <tr><td>enumeration</td><td>4</td></tr> <tr><td>enumeration</td><td>5</td></tr> <tr><td>enumeration</td><td>6</td></tr> <tr><td>enumeration</td><td>7</td></tr> <tr><td>enumeration</td><td>8</td></tr> <tr><td>enumeration</td><td>9</td></tr> <tr><td>enumeration</td><td>10</td></tr> <tr><td>enumeration</td><td>11</td></tr> <tr><td>enumeration</td><td>12</td></tr> <tr><td>enumeration</td><td>13</td></tr> <tr><td>enumeration</td><td>15</td></tr> <tr><td>enumeration</td><td>16</td></tr> <tr><td>enumeration</td><td>17</td></tr> <tr><td>enumeration</td><td>18</td></tr> <tr><td>enumeration</td><td>19</td></tr> <tr><td>enumeration</td><td>20</td></tr> <tr><td>enumeration</td><td>21</td></tr> <tr><td>enumeration</td><td>22</td></tr> </tbody> </table>	Kind	Value	enumeration	2	enumeration	3	enumeration	4	enumeration	5	enumeration	6	enumeration	7	enumeration	8	enumeration	9	enumeration	10	enumeration	11	enumeration	12	enumeration	13	enumeration	15	enumeration	16	enumeration	17	enumeration	18	enumeration	19	enumeration	20	enumeration	21	enumeration	22
Kind	Value																																										
enumeration	2																																										
enumeration	3																																										
enumeration	4																																										
enumeration	5																																										
enumeration	6																																										
enumeration	7																																										
enumeration	8																																										
enumeration	9																																										
enumeration	10																																										
enumeration	11																																										
enumeration	12																																										
enumeration	13																																										
enumeration	15																																										
enumeration	16																																										
enumeration	17																																										
enumeration	18																																										
enumeration	19																																										
enumeration	20																																										
enumeration	21																																										
enumeration	22																																										

simpleType **Rate10_Type**

type	restriction of DatoNP_Type																						
facets	<table border="1"> <thead> <tr> <th>Kind</th> <th>Value</th> </tr> </thead> <tbody> <tr><td>enumeration</td><td>1</td></tr> <tr><td>enumeration</td><td>2</td></tr> <tr><td>enumeration</td><td>3</td></tr> <tr><td>enumeration</td><td>4</td></tr> <tr><td>enumeration</td><td>5</td></tr> <tr><td>enumeration</td><td>6</td></tr> <tr><td>enumeration</td><td>7</td></tr> <tr><td>enumeration</td><td>8</td></tr> <tr><td>enumeration</td><td>9</td></tr> <tr><td>enumeration</td><td>10</td></tr> </tbody> </table>	Kind	Value	enumeration	1	enumeration	2	enumeration	3	enumeration	4	enumeration	5	enumeration	6	enumeration	7	enumeration	8	enumeration	9	enumeration	10
Kind	Value																						
enumeration	1																						
enumeration	2																						
enumeration	3																						
enumeration	4																						
enumeration	5																						
enumeration	6																						
enumeration	7																						
enumeration	8																						
enumeration	9																						
enumeration	10																						

simpleType Rate_Risparmio_Energetico_Type

type	restriction of DatoNP_Type										
facets	<table><thead><tr><th>Kind</th><th>Value</th></tr></thead><tbody><tr><td>enumeration</td><td>7</td></tr><tr><td>enumeration</td><td>8</td></tr><tr><td>enumeration</td><td>9</td></tr><tr><td>enumeration</td><td>10</td></tr></tbody></table>	Kind	Value	enumeration	7	enumeration	8	enumeration	9	enumeration	10
Kind	Value										
enumeration	7										
enumeration	8										
enumeration	9										
enumeration	10										

simpleType Reintegro_Totale_Parziale_Type

type	restriction of DatoN1_Type						
facets	<table><thead><tr><th>Kind</th><th>Value</th></tr></thead><tbody><tr><td>enumeration</td><td>1</td></tr><tr><td>enumeration</td><td>2</td></tr></tbody></table>	Kind	Value	enumeration	1	enumeration	2
Kind	Value						
enumeration	1						
enumeration	2						

simpleType Rettificativo_Type

type	restriction of DatoN1_Type								
facets	<table><thead><tr><th>Kind</th><th>Value</th></tr></thead><tbody><tr><td>enumeration</td><td>1</td></tr><tr><td>enumeration</td><td>2</td></tr><tr><td>enumeration</td><td>3</td></tr></tbody></table>	Kind	Value	enumeration	1	enumeration	2	enumeration	3
Kind	Value								
enumeration	1								
enumeration	2								
enumeration	3								

simpleType Serie_Registrazione_Contratto_Type

type	restriction of DatoAN_Type														
facets	<table><thead><tr><th>Kind</th><th>Value</th></tr></thead><tbody><tr><td>enumeration</td><td>3</td></tr><tr><td>enumeration</td><td>3A</td></tr><tr><td>enumeration</td><td>3B</td></tr><tr><td>enumeration</td><td>3P</td></tr><tr><td>enumeration</td><td>1T</td></tr><tr><td>enumeration</td><td>3T</td></tr></tbody></table>	Kind	Value	enumeration	3	enumeration	3A	enumeration	3B	enumeration	3P	enumeration	1T	enumeration	3T
Kind	Value														
enumeration	3														
enumeration	3A														
enumeration	3B														
enumeration	3P														
enumeration	1T														
enumeration	3T														

simpleType Stato_Civile_Type

type	restriction of DatoNP_Type								
facets	<table><thead><tr><th>Kind</th><th>Value</th></tr></thead><tbody><tr><td>enumeration</td><td>6</td></tr><tr><td>enumeration</td><td>7</td></tr><tr><td>enumeration</td><td>8</td></tr></tbody></table>	Kind	Value	enumeration	6	enumeration	7	enumeration	8
Kind	Value								
enumeration	6								
enumeration	7								
enumeration	8								

simpleType Terreni_Urbano_Type

type	restriction of DatoAN_Type						
facets	<table><thead><tr><th>Kind</th><th>Value</th></tr></thead><tbody><tr><td>enumeration</td><td>T</td></tr><tr><td>enumeration</td><td>U</td></tr></tbody></table>	Kind	Value	enumeration	T	enumeration	U
Kind	Value						
enumeration	T						
enumeration	U						

simpleType Tipo_Inquilino_Type

type	restriction of DatoNP_Type						
facets	<table><thead><tr><th>Kind</th><th>Value</th></tr></thead><tbody><tr><td>enumeration</td><td>1</td></tr><tr><td>enumeration</td><td>2</td></tr></tbody></table>	Kind	Value	enumeration	1	enumeration	2
Kind	Value						
enumeration	1						
enumeration	2						

	enumeration 4
--	---------------

simpleType Tipo_Intervento_Type

type	restriction of DatoNP_Type																																										
facets	<table border="1"> <thead> <tr> <th>Kind</th> <th>Value</th> </tr> </thead> <tbody> <tr><td>enumeration</td><td>1</td></tr> <tr><td>enumeration</td><td>2</td></tr> <tr><td>enumeration</td><td>3</td></tr> <tr><td>enumeration</td><td>4</td></tr> <tr><td>enumeration</td><td>5</td></tr> <tr><td>enumeration</td><td>6</td></tr> <tr><td>enumeration</td><td>7</td></tr> <tr><td>enumeration</td><td>8</td></tr> <tr><td>enumeration</td><td>9</td></tr> <tr><td>enumeration</td><td>10</td></tr> <tr><td>enumeration</td><td>11</td></tr> <tr><td>enumeration</td><td>12</td></tr> <tr><td>enumeration</td><td>13</td></tr> <tr><td>enumeration</td><td>14</td></tr> <tr><td>enumeration</td><td>15</td></tr> <tr><td>enumeration</td><td>16</td></tr> <tr><td>enumeration</td><td>30</td></tr> <tr><td>enumeration</td><td>31</td></tr> <tr><td>enumeration</td><td>32</td></tr> <tr><td>enumeration</td><td>33</td></tr> </tbody> </table>	Kind	Value	enumeration	1	enumeration	2	enumeration	3	enumeration	4	enumeration	5	enumeration	6	enumeration	7	enumeration	8	enumeration	9	enumeration	10	enumeration	11	enumeration	12	enumeration	13	enumeration	14	enumeration	15	enumeration	16	enumeration	30	enumeration	31	enumeration	32	enumeration	33
Kind	Value																																										
enumeration	1																																										
enumeration	2																																										
enumeration	3																																										
enumeration	4																																										
enumeration	5																																										
enumeration	6																																										
enumeration	7																																										
enumeration	8																																										
enumeration	9																																										
enumeration	10																																										
enumeration	11																																										
enumeration	12																																										
enumeration	13																																										
enumeration	14																																										
enumeration	15																																										
enumeration	16																																										
enumeration	30																																										
enumeration	31																																										
enumeration	32																																										
enumeration	33																																										

simpleType Tipo_Reddito_Da1a3_Type

type	restriction of DatoN1_Type								
facets	<table border="1"> <thead> <tr> <th>Kind</th> <th>Value</th> </tr> </thead> <tbody> <tr><td>enumeration</td><td>1</td></tr> <tr><td>enumeration</td><td>2</td></tr> <tr><td>enumeration</td><td>3</td></tr> </tbody> </table>	Kind	Value	enumeration	1	enumeration	2	enumeration	3
Kind	Value								
enumeration	1								
enumeration	2								
enumeration	3								

simpleType Tipo_Reddito_Da1a4_Type

type	restriction of DatoN1_Type										
facets	<table border="1"> <thead> <tr> <th>Kind</th> <th>Value</th> </tr> </thead> <tbody> <tr><td>enumeration</td><td>1</td></tr> <tr><td>enumeration</td><td>2</td></tr> <tr><td>enumeration</td><td>3</td></tr> <tr><td>enumeration</td><td>4</td></tr> </tbody> </table>	Kind	Value	enumeration	1	enumeration	2	enumeration	3	enumeration	4
Kind	Value										
enumeration	1										
enumeration	2										
enumeration	3										
enumeration	4										

simpleType Tipo_Reddito_Da1a8_Type

type	restriction of DatoNP_Type																		
facets	<table border="1"> <thead> <tr> <th>Kind</th> <th>Value</th> </tr> </thead> <tbody> <tr><td>enumeration</td><td>1</td></tr> <tr><td>enumeration</td><td>2</td></tr> <tr><td>enumeration</td><td>3</td></tr> <tr><td>enumeration</td><td>4</td></tr> <tr><td>enumeration</td><td>5</td></tr> <tr><td>enumeration</td><td>6</td></tr> <tr><td>enumeration</td><td>7</td></tr> <tr><td>enumeration</td><td>8</td></tr> </tbody> </table>	Kind	Value	enumeration	1	enumeration	2	enumeration	3	enumeration	4	enumeration	5	enumeration	6	enumeration	7	enumeration	8
Kind	Value																		
enumeration	1																		
enumeration	2																		
enumeration	3																		
enumeration	4																		
enumeration	5																		
enumeration	6																		
enumeration	7																		
enumeration	8																		

simpleType **Tipologia_Soggetto_Ass_Fisc_Type**

type	restriction of DatoN1_Type	
facets	Kind	Value
	enumeration	1
	enumeration	2
	enumeration	3
	enumeration	4
	enumeration	5

simpleType **Titolo_Terreno_Type**

type	restriction of DatoNP_Type	
facets	Kind	Value
	enumeration	1
	enumeration	2
	enumeration	3
	enumeration	4
	enumeration	5
	enumeration	6
	enumeration	7
	enumeration	10

simpleType **Utilizzo_Fabbricato_Type**

type	restriction of DatoNP_Type	
facets	Kind	Value
	enumeration	1
	enumeration	2
	enumeration	3
	enumeration	4
	enumeration	5
	enumeration	8
	enumeration	9
	enumeration	10
	enumeration	11
	enumeration	12
	enumeration	14
	enumeration	15
	enumeration	16
	enumeration	17

element **Documento**

diagram	<p>The diagram shows an element 'Documento' with a small square icon. A dashed yellow box labeled 'Documento_Type' encloses the 'Documento' element and its attribute 'identificativo'. The attribute 'identificativo' is shown in a box with a small square icon, indicating it is a required attribute. There is also an 'attributes' box with a minus sign icon, indicating that the element has other attributes.</p>				
type	Documento_Type				
attributes	Name	Type	Use	Default	Fixed
	identificativo	Identificativo_Type	required		

complexType Documento_Type

diagram					
attributes	Name identificativo	Type Identificativo_Type	Use required	Default	Fixed

attribute Documento_Type/@identificativo

type	Identificativo_Type
------	-------------------------------------

simpleType Identificativo_Type

type	restriction of <code>xs:string</code>
------	---------------------------------------

complexType Dati_Anagrafici_Type

diagram					
children	Cognome Nome Sesso DataNascita ComuneNascita ProvinciaNascita				

element Dati_Anagrafici_Type/Cognome

diagram					
type	DatoAN_Type				

element Dati_Anagrafici_Type/Nome

diagram					
type	DatoAN_Type				

element **Dati_Anagrafici_Type/Sesso**

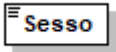
diagram							
type	Sesso_Type						
facets	<table><thead><tr><th>Kind</th><th>Value</th></tr></thead><tbody><tr><td>enumeration</td><td>M</td></tr><tr><td>enumeration</td><td>F</td></tr></tbody></table>	Kind	Value	enumeration	M	enumeration	F
Kind	Value						
enumeration	M						
enumeration	F						

element **Dati_Anagrafici_Type/DataNascita**

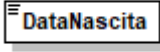
diagram	
type	DatoDT_Type

element **Dati_Anagrafici_Type/ComuneNascita**

diagram	
type	DatoAN_Type

element **Dati_Anagrafici_Type/ProvinciaNascita**

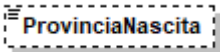
diagram	
type	PN_Type

complexType **Dati_Sottoscrittore_Type**

<p>diagram</p>	
<p>children</p>	<p>CodiceFiscale CodiceCarica CodiceFiscaleSocieta DatiAnagrafici ResidenzaEstera Telefono DataCarica InizioProcedura ProceduraNonTerminata FineProcedura</p>

element **Dati_Sottoscrittore_Type/CodiceFiscale**

<p>diagram</p>	
<p>type</p>	<p>DatoCF_Type</p>

element **Dati_Sottoscrittore_Type/CodiceCarica**

<p>diagram</p>																																	
<p>type</p>	<p>Codice Carica Type</p>																																
<p>facets</p>	<table border="1"> <thead> <tr> <th>Kind</th> <th>Value</th> </tr> </thead> <tbody> <tr><td>enumeration</td><td>1</td></tr> <tr><td>enumeration</td><td>2</td></tr> <tr><td>enumeration</td><td>3</td></tr> <tr><td>enumeration</td><td>4</td></tr> <tr><td>enumeration</td><td>5</td></tr> <tr><td>enumeration</td><td>6</td></tr> <tr><td>enumeration</td><td>7</td></tr> <tr><td>enumeration</td><td>8</td></tr> <tr><td>enumeration</td><td>9</td></tr> <tr><td>enumeration</td><td>10</td></tr> <tr><td>enumeration</td><td>11</td></tr> <tr><td>enumeration</td><td>12</td></tr> <tr><td>enumeration</td><td>13</td></tr> <tr><td>enumeration</td><td>14</td></tr> <tr><td>enumeration</td><td>15</td></tr> </tbody> </table>	Kind	Value	enumeration	1	enumeration	2	enumeration	3	enumeration	4	enumeration	5	enumeration	6	enumeration	7	enumeration	8	enumeration	9	enumeration	10	enumeration	11	enumeration	12	enumeration	13	enumeration	14	enumeration	15
Kind	Value																																
enumeration	1																																
enumeration	2																																
enumeration	3																																
enumeration	4																																
enumeration	5																																
enumeration	6																																
enumeration	7																																
enumeration	8																																
enumeration	9																																
enumeration	10																																
enumeration	11																																
enumeration	12																																
enumeration	13																																
enumeration	14																																
enumeration	15																																

element **Dati_Sottoscrittore_Type/CodiceFiscaleSocieta**

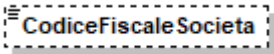
diagram	
type	DatoCN_Type

element **Dati_Sottoscrittore_Type/DatiAnagrafici**

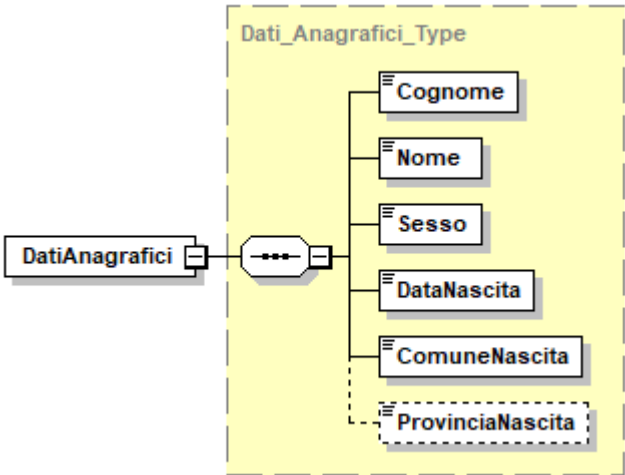
diagram	
type	Dati_Anagrafici_Type
children	Cognome Nome Sesso DataNascita ComuneNascita ProvinciaNascita

element **Dati_Sottoscrittore_Type/ResidenzaEstera**

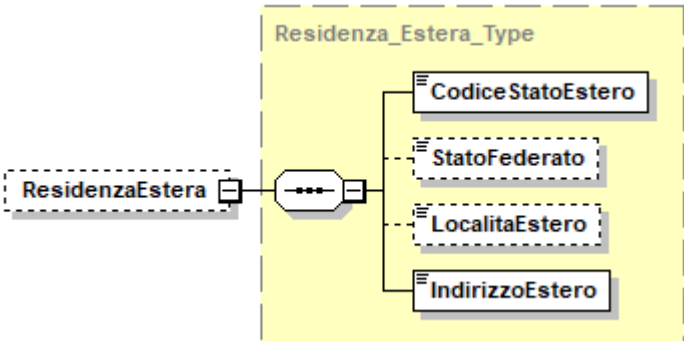
diagram	
type	Residenza_Estera_Type
children	CodiceStatoEstero StatoFederato LocalitaEstero IndirizzoEstero

element **Dati_Sottoscrittore_Type/Telefono**

diagram	
---------	---

type	DatoTL_Type
------	-----------------------------

element **Dati_Sottoscrittore_Type/DataCarica**

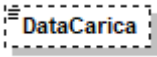
diagram	
type	DatoDT_Type

element **Dati_Sottoscrittore_Type/InizioProcedura**

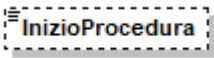
diagram	
type	DatoDT_Type

element **Dati_Sottoscrittore_Type/ProceduraNonTerminata**

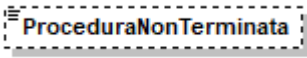
diagram	
type	DatoCB_Type

element **Dati_Sottoscrittore_Type/FineProcedura**

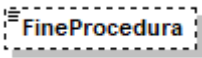
diagram	
type	DatoDT_Type

complexType **Domicilio_EE_Type**

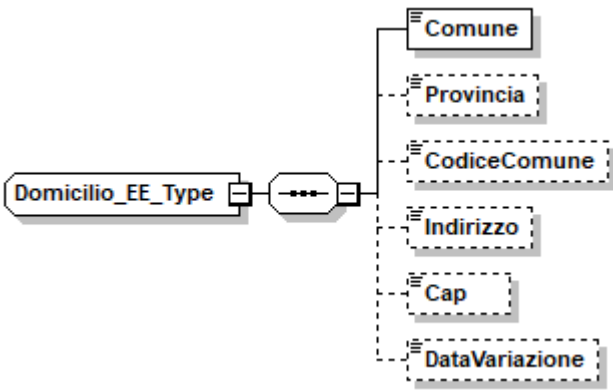
diagram	
children	Comune Provincia CodiceComune Indirizzo Cap DataVariazione

element **Domicilio_EE_Type/Comune**

diagram	 A diagram showing a rectangular box with the word "Comune" inside. To the left of the box are three horizontal lines, indicating a list or array structure.
type	DatoAN_Type

element **Domicilio_EE_Type/Provincia**

diagram	 A diagram showing a dashed rectangular box with the word "Provincia" inside. To the left of the box are three horizontal lines, indicating a list or array structure.
type	PE_Type

element **Domicilio_EE_Type/CodiceComune**

diagram	 A diagram showing a dashed rectangular box with the word "CodiceComune" inside. To the left of the box are three horizontal lines, indicating a list or array structure.
type	DatoAN_Type

element **Domicilio_EE_Type/Indirizzo**

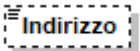
diagram	 A diagram showing a dashed rectangular box with the word "Indirizzo" inside. To the left of the box are three horizontal lines, indicating a list or array structure.
type	DatoAN_Type

element **Domicilio_EE_Type/Cap**

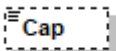
diagram	 A diagram showing a dashed rectangular box with the word "Cap" inside. To the left of the box are three horizontal lines, indicating a list or array structure.
type	DatoCP_Type

element **Domicilio_EE_Type/DataVariazione**

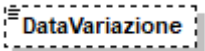
diagram	 A diagram showing a dashed rectangular box with the word "DataVariazione" inside. To the left of the box are three horizontal lines, indicating a list or array structure.
type	DatoD6_Type

complexType **Domicilio_Fiscale_Type**

diagram	
type	extension of Domicilio_Ita_Type
children	Comune Provincia CodiceComune Indirizzo Cap DataVariazione

element **Domicilio_Fiscale_Type/DataVariazione**

diagram	
type	DatoD6_Type

complexType **Domicilio_Ita_Type**

diagram	
children	Comune Provincia CodiceComune Indirizzo Cap

element **Domicilio_Ita_Type/Comune**

diagram	
type	DatoAN_Type

element **Domicilio_Ita_Type/Provincia**

diagram	
type	PR_Type

element **Domicilio_Ita_Type/CodiceComune**

diagram	
type	DatoAN_Type

element **Domicilio_Ita_Type/Indirizzo**

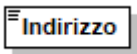
diagram	
type	DatoAN_Type

element **Domicilio_Ita_Type/Cap**

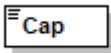
diagram	
type	DatoCP_Type

complexType **Firma_Revisione_Type**

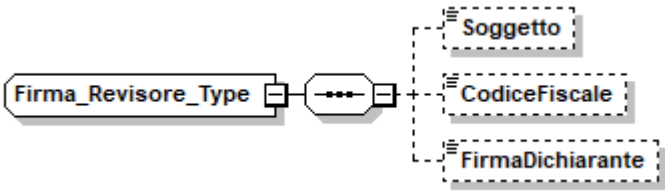
diagram	
children	Soggetto CodiceFiscale FirmaDichiarante

element **Firma_Revisione_Type/Soggetto**

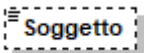
diagram	
type	restriction of DatoNP_Type

element **Firma_Revisione_Type/CodiceFiscale**

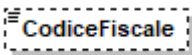
diagram	
---------	---

type	DatoCF_Type
------	-----------------------------

element **Firma_Revisore_Type/FirmaDichiarante**

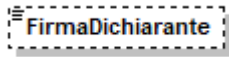
diagram	
type	DatoCB_Type

complexType **Firma_Type**

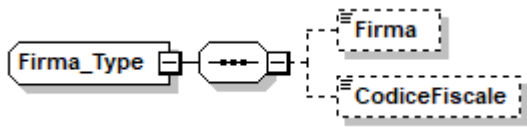
diagram	
children	Firma CodiceFiscale

element **Firma_Type/Firma**

diagram	
type	DatoCB_Type

element **Firma_Type/CodiceFiscale**

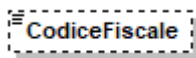
diagram	
type	restriction of xs:string

complexType **Frontespizio_Type**

diagram	
children	SoggettoFiscale

element **Frontespizio_Type/SoggettoFiscale**

diagram	
type	Soggetto_Fiscale_Type
children	CodiceFiscale Email Telefono Fax

complexType **Impegno_A_Trasmettere_Type**

diagram	
children	CFintermediario NumerolscrAlboCAF ImpegnoATrasmettere RicezioneAvvisoTelem DataImpegno FirmaIntermediario

element **Impegno_A_Trasmettere_Type/CFintermediario**

diagram	
type	DatoCF_Type

element **Impegno_A_Trasmettere_Type/NumerolscrAlboCAF**

diagram	
type	restriction of DatoNU_Type

element **Impegno_A_Trasmettere_Type/ImpegnoATrasmettere**

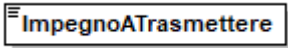
diagram							
type	restriction of DatoNP_Type						
facets	<table border="1"> <thead> <tr> <th>Kind</th> <th>Value</th> </tr> </thead> <tbody> <tr> <td>enumeration</td> <td>1</td> </tr> <tr> <td>enumeration</td> <td>2</td> </tr> </tbody> </table>	Kind	Value	enumeration	1	enumeration	2
Kind	Value						
enumeration	1						
enumeration	2						

element **Impegno_A_Trasmettere_Type/RicezioneAvvisoTelem**

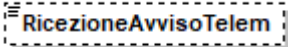
diagram	
type	DatoCB_Type

element **Impegno_A_Trasmettere_Type/DatalImpegno**

diagram	
type	DatoDT_Type

element **Impegno_A_Trasmettere_Type/FirmaIntermediario**

diagram	
type	DatoCB_Type

complexType **Persone_Fisiche_Type**

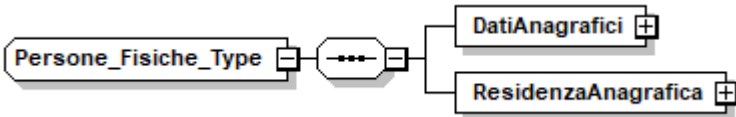
diagram	
children	DatiAnagrafici ResidenzaAnagrafica

element **Persone_Fisiche_Type/DatiAnagrafici**

<p>diagram</p>	
<p>type</p>	<p>Dati_Anagrafici_Type</p>
<p>children</p>	<p>Cognome Nome Sesso DataNascita ComuneNascita ProvinciaNascita</p>

element **Persone_Fisiche_Type/ResidenzaAnagrafica**

<p>diagram</p>	
<p>type</p>	<p>Residenza_Anagrafica_Type</p>
<p>children</p>	<p>Comune Provincia CodiceComune Indirizzo Cap DataVariazione</p>

complexType **Residenza_Anagrafica_Type**

diagram	
type	extension of Domicilio_Ita_Type
children	Comune Provincia CodiceComune Indirizzo Cap DataVariazione

element **Residenza_Anagrafica_Type/DataVariazione**

diagram	
type	DatoDT_Type

complexType **Residenza_Estera_Type**

diagram	
children	CodiceStatoEstero StatoFederato LocalitaEstero IndirizzoEstero

element **Residenza_Estera_Type/CodiceStatoEstero**

diagram	
type	restriction of DatoAN_Type

element **Residenza_Estera_Type/StatoFederato**

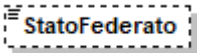
diagram	
type	restriction of DatoAN_Type

element **Residenza_Estera_Type/LocalitaEstero**

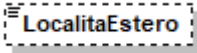
diagram	
type	DatoAN_Type

element **Residenza_Estera_Type/IndirizzoEstero**

diagram	
type	DatoAN_Type

complexType **Soggetti_Diversi_Da_PF_Type**

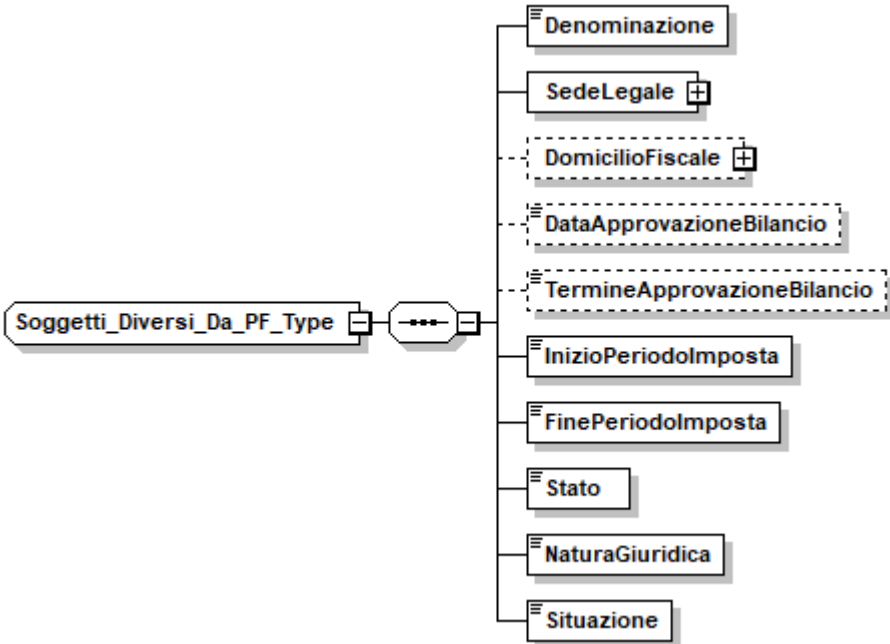
diagram	
children	Denominazione SedeLegale DomicilioFiscale DataApprovazioneBilancio TermineApprovazioneBilancio InizioPeriodoImposta FinePeriodoImposta Stato NaturaGiuridica Situazione

element **Soggetti_Diversi_Da_PF_Type/Denominazione**

diagram	
---------	---

type	DatoAN Type
------	-----------------------------

element **Soggetti_Diversi_Da_PF_Type/SedeLegale**

diagram	<p>The diagram shows a class SedeLegale connected to a class Domicilio_EE_Type. Domicilio_EE_Type is highlighted in a yellow dashed box and contains the following fields: Comune, Provincia, CodiceComune, Indirizzo, Cap, and DataVariazione. The connection between SedeLegale and Domicilio_EE_Type is shown with a solid line and a small square on the SedeLegale side.</p>
type	Domicilio_EE_Type
children	Comune Provincia CodiceComune Indirizzo Cap DataVariazione

element **Soggetti_Diversi_Da_PF_Type/DomicilioFiscale**

diagram	<p>The diagram shows a class DomicilioFiscale connected to a class Domicilio_Fiscale_Type. Domicilio_Fiscale_Type is highlighted in a yellow dashed box and contains the following fields: Comune, Provincia, CodiceComune, Indirizzo, Cap, and DataVariazione. The connection between DomicilioFiscale and Domicilio_Fiscale_Type is shown with a solid line and a small square on the DomicilioFiscale side.</p>
type	Domicilio_Fiscale_Type
children	Comune Provincia CodiceComune Indirizzo Cap DataVariazione

element **Soggetti_Diversi_Da_PF_Type/DataApprovazioneBilancio**

diagram	<p>The diagram shows a class DataApprovazioneBilancio highlighted in a dashed box.</p>
type	DatoDT Type

element **Soggetti_Diversi_Da_PF_Type/TermineApprovazioneBilancio**

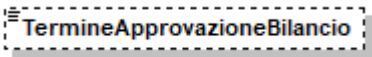
diagram	
type	DatoDT_Type

element **Soggetti_Diversi_Da_PF_Type/InizioPeriodoImposta**

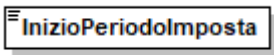
diagram	
type	DatoDT_Type

element **Soggetti_Diversi_Da_PF_Type/FinePeriodoImposta**

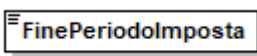
diagram	
type	DatoDT_Type

element **Soggetti_Diversi_Da_PF_Type/Stato**

diagram											
type	Stato_Type										
facets	<table border="1"> <thead> <tr> <th>Kind</th> <th>Value</th> </tr> </thead> <tbody> <tr> <td>enumeration</td> <td>1</td> </tr> <tr> <td>enumeration</td> <td>2</td> </tr> <tr> <td>enumeration</td> <td>3</td> </tr> <tr> <td>enumeration</td> <td>4</td> </tr> </tbody> </table>	Kind	Value	enumeration	1	enumeration	2	enumeration	3	enumeration	4
Kind	Value										
enumeration	1										
enumeration	2										
enumeration	3										
enumeration	4										

element **Soggetti_Diversi_Da_PF_Type/NaturaGiuridica**

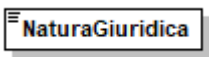
diagram																															
type	Natura_Giuridica_Type																														
facets	<table border="1"> <thead> <tr> <th>Kind</th> <th>Value</th> </tr> </thead> <tbody> <tr><td>enumeration</td><td>1</td></tr> <tr><td>enumeration</td><td>2</td></tr> <tr><td>enumeration</td><td>3</td></tr> <tr><td>enumeration</td><td>4</td></tr> <tr><td>enumeration</td><td>5</td></tr> <tr><td>enumeration</td><td>6</td></tr> <tr><td>enumeration</td><td>7</td></tr> <tr><td>enumeration</td><td>8</td></tr> <tr><td>enumeration</td><td>9</td></tr> <tr><td>enumeration</td><td>10</td></tr> <tr><td>enumeration</td><td>11</td></tr> <tr><td>enumeration</td><td>12</td></tr> <tr><td>enumeration</td><td>13</td></tr> <tr><td>enumeration</td><td>14</td></tr> </tbody> </table>	Kind	Value	enumeration	1	enumeration	2	enumeration	3	enumeration	4	enumeration	5	enumeration	6	enumeration	7	enumeration	8	enumeration	9	enumeration	10	enumeration	11	enumeration	12	enumeration	13	enumeration	14
Kind	Value																														
enumeration	1																														
enumeration	2																														
enumeration	3																														
enumeration	4																														
enumeration	5																														
enumeration	6																														
enumeration	7																														
enumeration	8																														
enumeration	9																														
enumeration	10																														
enumeration	11																														
enumeration	12																														
enumeration	13																														
enumeration	14																														

enumeration	15
enumeration	16
enumeration	17
enumeration	18
enumeration	19
enumeration	20
enumeration	21
enumeration	22
enumeration	23
enumeration	24
enumeration	25
enumeration	26
enumeration	27
enumeration	28
enumeration	29
enumeration	30
enumeration	31
enumeration	32
enumeration	33
enumeration	34
enumeration	35
enumeration	36
enumeration	37
enumeration	38
enumeration	39
enumeration	40
enumeration	41
enumeration	42
enumeration	43
enumeration	44
enumeration	45
enumeration	50
enumeration	51
enumeration	52
enumeration	53
enumeration	54
enumeration	55
enumeration	56
enumeration	57
enumeration	58
enumeration	59

element **Soggetti_Diversi_Da_PF_Type/Situazione**

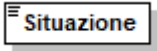
diagram		
type	Situazione Type	
facets	Kind	Value
	enumeration	1
	enumeration	2
	enumeration	3
	enumeration	4
	enumeration	5
	enumeration	6
	enumeration	7

complexType **Soggetti_Non_Residenti_Type**

diagram	
children	StatoEsteroResidenza CodiceStatoEstero CodiceIdentificazioneEstero

element **Soggetti_Non_Residenti_Type/StatoEsteroResidenza**

diagram	
type	DatoAN_Type

element **Soggetti_Non_Residenti_Type/CodiceStatoEstero**

diagram	
type	DatoAN_Type

element **Soggetti_Non_Residenti_Type/CodiceIdentificazioneEstero**

diagram	
type	DatoAN_Type

complexType **Soggetto_Fiscale_Type**

diagram	
children	CodiceFiscale Email Telefono Fax

element **Soggetto_Fiscale_Type/CodiceFiscale**

diagram	
type	DatoCF_Type

element **Soggetto_Fiscale_Type/Email**

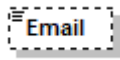
diagram	
type	DatoEM_Type

element **Soggetto_Fiscale_Type/Telefono**

diagram	
type	DatoTL_Type

element **Soggetto_Fiscale_Type/Fax**

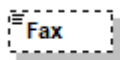
diagram	
type	DatoTL_Type

complexType **Tipo_Dichiarazione_Type**

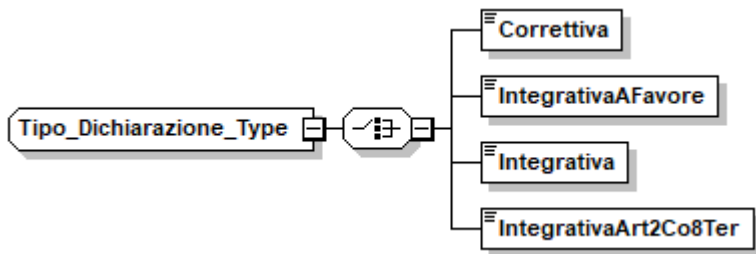
diagram	
children	Correttiva IntegrativaAFavore Integrativa IntegrativaArt2Co8Ter

element **Tipo_Dichiarazione_Type/Correttiva**

diagram	
type	DatoCB_Type

element **Tipo_Dichiarazione_Type/IntegrativaAFavore**

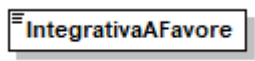
diagram	
type	DatoCB_Type

element **Tipo_Dichiarazione_Type/Integrativa**

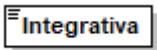
diagram	
type	DatoCB_Type

element **Tipo_Dichiarazione_Type/IntegrativaArt2Co8Ter**

diagram	
type	DatoCB_Type

complexType **Visto_Conformita_Type**

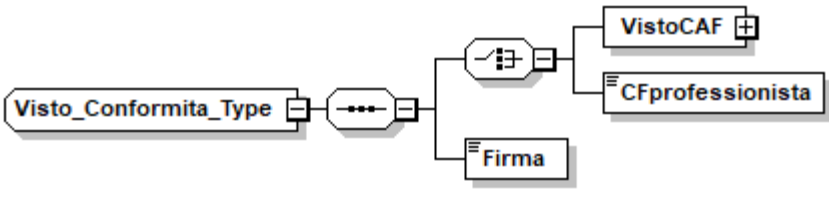
diagram	
children	VistoCAF CFprofessionista Firma

element **Visto_Conformita_Type/VistoCAF**

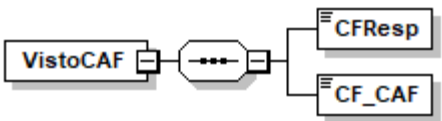
diagram	
children	CFResp CF_CAF

element **Visto_Conformita_Type/VistoCAF/CFResp**

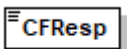
diagram	
type	DatoCF_Type

element **Visto_Conformita_Type/VistoCAF/CF_CAF**

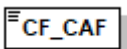
diagram	
type	DatoCN_Type

element **Visto_Conformita_Type/CFprofessionista**

diagram	
type	DatoCF_Type

element **Visto_Conformita_Type/Firma**

diagram	
type	DatoCB_Type

complexType **Scelta2PerMille_Type**

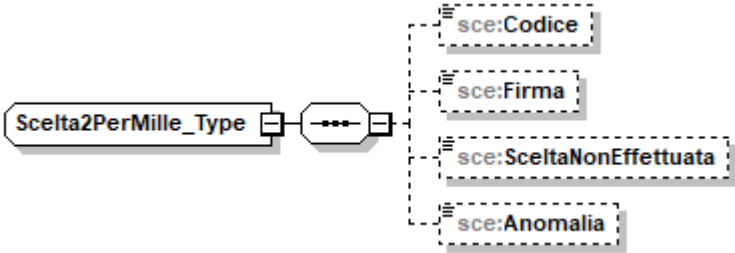
diagram	
children	sce:Codice sce:Firma sce:SceltaNonEffettuata sce:Anomalia

element **Scelta2PerMille_Type/Codice**

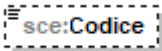
diagram	
type	DatoAN_Type

element **Scelta2PerMille_Type/Firma**

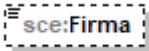
diagram	
type	DatoCB_Type

element **Scelta2PerMille_Type/SceltaNonEffettuata**

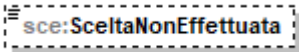
diagram	
type	DatoCB_Type

element **Scelta2PerMille_Type/Anomalia**

diagram											
type	restriction of DatoN1_Type										
facets	<table border="1"> <thead> <tr> <th>Kind</th> <th>Value</th> </tr> </thead> <tbody> <tr> <td>enumeration</td> <td>1</td> </tr> <tr> <td>enumeration</td> <td>2</td> </tr> <tr> <td>enumeration</td> <td>3</td> </tr> <tr> <td>enumeration</td> <td>4</td> </tr> </tbody> </table>	Kind	Value	enumeration	1	enumeration	2	enumeration	3	enumeration	4
Kind	Value										
enumeration	1										
enumeration	2										
enumeration	3										
enumeration	4										

complexType **Scelta2PerMilleAssCult_Type**

diagram	
type	extension of Firma_Type
children	Firma CodiceFiscale sce:SceltaNonEffettuata sce:Anomalia

element **Scelta2PerMilleAssCult_Type/SceltaNonEffettuata**

diagram	
type	DatoCB_Type

element **Scelta2PerMilleAssCult_Type/Anomalia**

diagram											
type	restriction of DatoN1_Type										
facets	<table border="1"> <thead> <tr> <th>Kind</th> <th>Value</th> </tr> </thead> <tbody> <tr> <td>enumeration</td> <td>1</td> </tr> <tr> <td>enumeration</td> <td>2</td> </tr> <tr> <td>enumeration</td> <td>4</td> </tr> <tr> <td>enumeration</td> <td>5</td> </tr> </tbody> </table>	Kind	Value	enumeration	1	enumeration	2	enumeration	4	enumeration	5
Kind	Value										
enumeration	1										
enumeration	2										
enumeration	4										
enumeration	5										

complexType **Scelta5PerMille_Type**

<p>diagram</p>	
<p>children</p>	<p>sce:SostegnoVolontariatoNonLucrative sce:RicercaScientifica sce:RicercaSanitaria sce:BeniCulturaliPaesaggistici sce:SostegnoSocialeComune sce:SostegnoAssociazioniSportive sce:SostegnoEntiAreeProtette sce:SceltaNonEffettuata sce:Anomalia sce:FlagAnomaliaCFbeneficiario</p>

element **Scelta5PerMille_Type/SostegnoVolontariatoNonLucrative**

<p>diagram</p>	
<p>type</p>	<p>Firma_Type</p>
<p>children</p>	<p>Firma CodiceFiscale</p>

element **Scelta5PerMille_Type/RicercaScientifica**

<p>diagram</p>	
<p>type</p>	<p>Firma_Type</p>
<p>children</p>	<p>Firma CodiceFiscale</p>

element **Scelta5PerMille_Type/RicercaSanitaria**

diagram	<p>The diagram shows a class <code>sc:Firma_Type</code> (highlighted in yellow) containing two attributes: <code>Firma</code> and <code>CodiceFiscale</code>. A dashed box labeled <code>sce:RicercaSanitaria</code> is connected to the <code>sc:Firma_Type</code> class by a solid line with an open arrowhead pointing towards the class.</p>
type	Firma_Type
children	Firma CodiceFiscale

element **Scelta5PerMille_Type/BeniCulturaliPaesaggistici**

diagram	<p>The diagram shows a class <code>sc:Firma_Type</code> (highlighted in yellow) containing two attributes: <code>Firma</code> and <code>CodiceFiscale</code>. A dashed box labeled <code>sce:BeniCulturaliPaesaggistici</code> is connected to the <code>sc:Firma_Type</code> class by a solid line with an open arrowhead pointing towards the class.</p>
type	Firma_Type
children	Firma CodiceFiscale

element **Scelta5PerMille_Type/SostegnoSocialeComune**

diagram	<p>The diagram shows a dashed box labeled <code>sce:Sostegno Sociale Comune</code> connected to a solid box labeled <code>sce:Firma</code> by a solid line with an open arrowhead pointing towards <code>sce:Firma</code>.</p>
children	sce:Firma

element **Scelta5PerMille_Type/SostegnoSocialeComune/Firma**

diagram	<p>The diagram shows a single solid box labeled <code>sce:Firma</code>.</p>
type	DatoCB_Type

element **Scelta5PerMille_Type/SostegnoAssociazioniSportive**

diagram	
type	Firma_Type
children	Firma CodiceFiscale

element **Scelta5PerMille_Type/SostegnoEntiAreeProtette**

diagram	
type	Firma_Type
children	Firma CodiceFiscale

element **Scelta5PerMille_Type/SceltaNonEffettuata**

diagram	
type	DatoCB_Type

element **Scelta5PerMille_Type/Anomalia**

diagram													
type	restriction of DatoN1_Type												
facets	<table border="1"> <thead> <tr> <th>Kind</th> <th>Value</th> </tr> </thead> <tbody> <tr> <td>enumeration</td> <td>1</td> </tr> <tr> <td>enumeration</td> <td>2</td> </tr> <tr> <td>enumeration</td> <td>3</td> </tr> <tr> <td>enumeration</td> <td>4</td> </tr> <tr> <td>enumeration</td> <td>5</td> </tr> </tbody> </table>	Kind	Value	enumeration	1	enumeration	2	enumeration	3	enumeration	4	enumeration	5
Kind	Value												
enumeration	1												
enumeration	2												
enumeration	3												
enumeration	4												
enumeration	5												

element **Scelta5PerMille_Type/FlagAnomaliaCFbeneficiario**

diagram	
type	DatoCB_Type

complexType **Scelta8PerMille_Type**

<p>diagram</p>	
<p>children</p>	<p>sce:Stato sce:ChiesaCattolica sce:UnioneChieseCristianeAvventiste7giorno sce:AssembleeDiDioInItalia sce:UnioneDelleChieseMetodisteValdesi sce:ChiesaEvangelicaLuteranaInItalia sce:UnioneComunitaEbraicheItaliane sce:SacraArcidiocesiOrtodossaEsarcato sce:ChiesaApostolicaItalia sce:UnioneCristianaEvangelicaBattista sce:UnioneBuddhistaItaliana sce:UnioneInduistaItaliana sce:IstitutoBuddistaIbisg sce:ChiesaInghilterraItalia sce:SceltaNonEffettuata sce:Anomalia</p>

element **Scelta8PerMille_Type/Stato**

<p>diagram</p>	
----------------	--

type	sce:Stato_Type
children	sce:Codice sce:Firma

element **Scelta8PerMille_Type/ChiesaCattolica**

diagram	
type	DatoCB_Type

element **Scelta8PerMille_Type/UnioneChieseCristianeAvventiste7giorno**

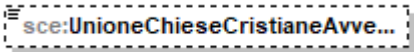
diagram	
type	DatoCB_Type

element **Scelta8PerMille_Type/AssembleeDiDioInItalia**

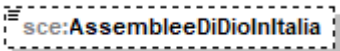
diagram	
type	DatoCB_Type

element **Scelta8PerMille_Type/UnioneDelleChieseMetodisteValdesi**

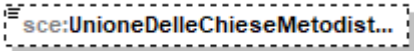
diagram	
type	DatoCB_Type

element **Scelta8PerMille_Type/ChiesaEvangelicaLuteranaInItalia**

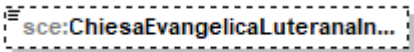
diagram	
type	DatoCB_Type

element **Scelta8PerMille_Type/UnioneComunitaEbraicheItaliane**

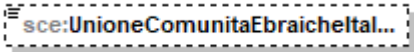
diagram	
type	DatoCB_Type

element **Scelta8PerMille_Type/SacraArcidiocesiOrtodossaEsarcato**

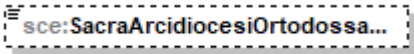
diagram	
type	DatoCB_Type

element **Scelta8PerMille_Type/ChiesaApostolicitalia**

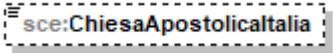
diagram	
type	DatoCB_Type

element **Scelta8PerMille_Type/UnioneCristianaEvangelicaBattista**

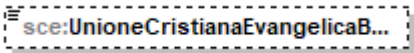
diagram	
type	DatoCB_Type

element **Scelta8PerMille_Type/UnioneBuddhistaitaliana**

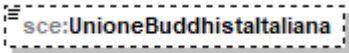
diagram	
type	DatoCB_Type

element **Scelta8PerMille_Type/UnioneInduistaitaliana**

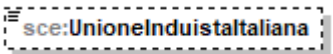
diagram	
type	DatoCB_Type

element **Scelta8PerMille_Type/IstitutoBuddistalbisg**

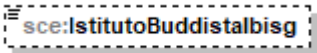
diagram	
type	DatoCB_Type

element **Scelta8PerMille_Type/ChiesaInghilterraltalia**

diagram	
type	DatoCB_Type

element **Scelta8PerMille_Type/SceltaNonEffettuata**

diagram	 The diagram shows a dashed rectangular box containing the text "sce:SceltaNonEffettuata".
type	DatoCB_Type

element **Scelta8PerMille_Type/Anomalia**

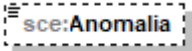
diagram	 The diagram shows a dashed rectangular box containing the text "sce:Anomalia".														
type	restriction of DatoN1_Type														
facets	<table border="1"> <thead> <tr> <th>Kind</th> <th>Value</th> </tr> </thead> <tbody> <tr> <td>enumeration</td> <td>1</td> </tr> <tr> <td>enumeration</td> <td>2</td> </tr> <tr> <td>enumeration</td> <td>3</td> </tr> <tr> <td>enumeration</td> <td>4</td> </tr> <tr> <td>enumeration</td> <td>5</td> </tr> <tr> <td>enumeration</td> <td>6</td> </tr> </tbody> </table>	Kind	Value	enumeration	1	enumeration	2	enumeration	3	enumeration	4	enumeration	5	enumeration	6
Kind	Value														
enumeration	1														
enumeration	2														
enumeration	3														
enumeration	4														
enumeration	5														
enumeration	6														

complexType **Scelte_Type**

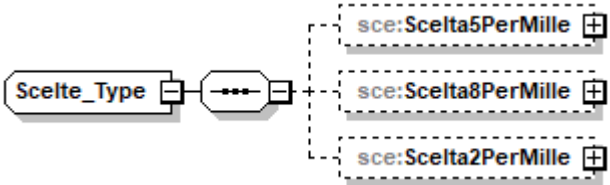
diagram	 The diagram shows a sequence container (rectangle with a small square on the left) containing the text "Scelte_Type". This is followed by a sequence container with four dots inside. To the right, three dashed boxes are connected to the sequence container, each containing a text label and a plus sign: "sce:Scelta5PerMille +", "sce:Scelta8PerMille +", and "sce:Scelta2PerMille +".
children	sce:Scelta5PerMille sce:Scelta8PerMille sce:Scelta2PerMille

element **Scelte_Type/Scelta5PerMille**

<p>diagram</p>	
<p>type</p>	<p>sce:Scelta5PerMille_Type</p>
<p>children</p>	<p>sce:SostegnoVolontariatoNonLucrative sce:RicercaScientifica sce:RicercaSanitaria sce:BeniCulturaliPaesaggistici sce:SostegnoSocialeComune sce:SostegnoAssociazioniSportive sce:SostegnoEntiAreeProtette sce:SceltaNonEffettuata sce:Anomalia sce:FlagAnomaliaCFbeneficiario</p>

element **Scelte_Type/Scelta8PerMille**

<p>diagram</p>	
<p>type</p>	<p>sce:Scelta8PerMille_Type</p>
<p>children</p>	<p> sce:Stato sce:ChiesaCattolica sce:UnioneChieseCristianeAvventiste7giorno sce:AssembleeDiDioInItalia sce:UnioneDelleChieseMetodisteValdesi sce:ChiesaEvangelicaLuteranaInItalia sce:UnioneComunitaEbraicheItaliane sce:SacraArcidiocesiOrtodossaEsarcato sce:ChiesaApostolicaItalia sce:UnioneCristianaEvangelicaBattista sce:UnioneBuddhistaItaliana sce:UnioneInduistaItaliana sce:IstitutoBuddistaBisg sce:ChiesaInghilterraItalia sce:SceltaNonEffettuata sce:Anomalia </p>

element **Scelte_Type/Scelta2PerMille**

diagram	
type	sce:Scelta2PerMille_Type
children	sce:Codice sce:Firma sce:SceltaNonEffettuata sce:Anomalia

complexType **Stato_Type**

diagram	
children	sce:Codice sce:Firma

element **Stato_Type/Codice**

diagram															
type	restriction of DatoAN_Type														
facets	<table border="1"> <thead> <tr> <th>Kind</th> <th>Value</th> </tr> </thead> <tbody> <tr> <td>enumeration</td> <td>1</td> </tr> <tr> <td>enumeration</td> <td>2</td> </tr> <tr> <td>enumeration</td> <td>3</td> </tr> <tr> <td>enumeration</td> <td>4</td> </tr> <tr> <td>enumeration</td> <td>5</td> </tr> <tr> <td>enumeration</td> <td>6</td> </tr> </tbody> </table>	Kind	Value	enumeration	1	enumeration	2	enumeration	3	enumeration	4	enumeration	5	enumeration	6
Kind	Value														
enumeration	1														
enumeration	2														
enumeration	3														
enumeration	4														
enumeration	5														
enumeration	6														

element **Stato_Type/Firma**

diagram	
type	DatoCB_Type

simpleType **DatoAN_Type**

type	restriction of xs:string
------	---------------------------------

simpleType **DatoCB12_Type**

type	restriction of xs:byte
------	-------------------------------

simpleType **DatoCB_Type**

type	restriction of xs:byte
------	-------------------------------

simpleType **DatoCF_Type**

type	restriction of xs:string
------	---------------------------------

simpleType **DatoCN_Type**

type	restriction of xs:string
------	---------------------------------

simpleType **DatoCP_Type**

type	restriction of xs:string
------	---------------------------------

simpleType **DatoD6_Type**

type	restriction of xs:string
------	---------------------------------

simpleType **DatoDA_Type**

type	restriction of xs:string
------	---------------------------------

simpleType **DatoDN_Type**

type	restriction of xs:string
------	---------------------------------

simpleType **DatoDT_Type**

type	restriction of xs:string
------	---------------------------------

simpleType **DatoEM_Type**

type	restriction of xs:string
------	---------------------------------

simpleType **DatoGA_Type**

type	restriction of xs:string
------	---------------------------------

simpleType **DatoN1_Type**

type	restriction of xs:string
------	---------------------------------

simpleType **DatoNP_Type**

type	restriction of xs:string
------	---------------------------------

simpleType **DatoNU_Type**

type	restriction of xs:string
------	---------------------------------

simpleType **DatoPC_Type**

type	restriction of xs:string
------	---------------------------------

simpleType **DatoPI_Type**

type	restriction of xs:string
------	---------------------------------

simpleType **DatoQU_Type**

type	restriction of xs:string
------	---------------------------------

simpleType **DatoTL_Type**

type	restriction of xs:string
------	---------------------------------

simpleType **DatoVP_Type**

type	restriction of xs:string
------	---------------------------------

simpleType **Casella_Quadro_Type**

type	restriction of DatoAN_Type										
facets	<table><thead><tr><th>Kind</th><th>Value</th></tr></thead><tbody><tr><td>enumeration</td><td>0</td></tr><tr><td>enumeration</td><td>1</td></tr><tr><td>enumeration</td><td>2</td></tr><tr><td>enumeration</td><td>3</td></tr></tbody></table>	Kind	Value	enumeration	0	enumeration	1	enumeration	2	enumeration	3
Kind	Value										
enumeration	0										
enumeration	1										
enumeration	2										
enumeration	3										

simpleType **Codice_Carica_Type**

type	restriction of DatoNP_Type												
facets	<table><thead><tr><th>Kind</th><th>Value</th></tr></thead><tbody><tr><td>enumeration</td><td>1</td></tr><tr><td>enumeration</td><td>2</td></tr><tr><td>enumeration</td><td>3</td></tr><tr><td>enumeration</td><td>4</td></tr><tr><td>enumeration</td><td>5</td></tr></tbody></table>	Kind	Value	enumeration	1	enumeration	2	enumeration	3	enumeration	4	enumeration	5
Kind	Value												
enumeration	1												
enumeration	2												
enumeration	3												
enumeration	4												
enumeration	5												

	enumeration	6
	enumeration	7
	enumeration	8
	enumeration	9
	enumeration	10
	enumeration	11
	enumeration	12
	enumeration	13
	enumeration	14
	enumeration	15

simpleType Codice_Regione_Type

type	restriction of DatoAN_Type	
facets	Kind	Value
	enumeration	1
	enumeration	2
	enumeration	3
	enumeration	4
	enumeration	5
	enumeration	6
	enumeration	7
	enumeration	8
	enumeration	9
	enumeration	10
	enumeration	11
	enumeration	12
	enumeration	13
	enumeration	14
	enumeration	15
	enumeration	16
	enumeration	17
	enumeration	18
	enumeration	19
	enumeration	20
	enumeration	21

simpleType Natura_Giuridica_Type

type	restriction of DatoNP_Type	
facets	Kind	Value
	enumeration	1
	enumeration	2
	enumeration	3
	enumeration	4
	enumeration	5
	enumeration	6
	enumeration	7
	enumeration	8
	enumeration	9
	enumeration	10
	enumeration	11
	enumeration	12
	enumeration	13
	enumeration	14
	enumeration	15
	enumeration	16
	enumeration	17
	enumeration	18
	enumeration	19
	enumeration	20
	enumeration	21
	enumeration	22
	enumeration	23
	enumeration	24

enumeration	25
enumeration	26
enumeration	27
enumeration	28
enumeration	29
enumeration	30
enumeration	31
enumeration	32
enumeration	33
enumeration	34
enumeration	35
enumeration	36
enumeration	37
enumeration	38
enumeration	39
enumeration	40
enumeration	41
enumeration	42
enumeration	43
enumeration	44
enumeration	45
enumeration	50
enumeration	51
enumeration	52
enumeration	53
enumeration	54
enumeration	55
enumeration	56
enumeration	57
enumeration	58
enumeration	59

simpleType Sesso_Type

type	restriction of DatoAN_Type						
facets	<table border="0"> <tr><td>Kind</td><td>Value</td></tr> <tr><td>enumeration</td><td>M</td></tr> <tr><td>enumeration</td><td>F</td></tr> </table>	Kind	Value	enumeration	M	enumeration	F
Kind	Value						
enumeration	M						
enumeration	F						

simpleType Situazione_Type

type	restriction of DatoNP_Type																
facets	<table border="0"> <tr><td>Kind</td><td>Value</td></tr> <tr><td>enumeration</td><td>1</td></tr> <tr><td>enumeration</td><td>2</td></tr> <tr><td>enumeration</td><td>3</td></tr> <tr><td>enumeration</td><td>4</td></tr> <tr><td>enumeration</td><td>5</td></tr> <tr><td>enumeration</td><td>6</td></tr> <tr><td>enumeration</td><td>7</td></tr> </table>	Kind	Value	enumeration	1	enumeration	2	enumeration	3	enumeration	4	enumeration	5	enumeration	6	enumeration	7
Kind	Value																
enumeration	1																
enumeration	2																
enumeration	3																
enumeration	4																
enumeration	5																
enumeration	6																
enumeration	7																

simpleType Stato_Type

type	restriction of DatoNP_Type										
facets	<table border="0"> <tr><td>Kind</td><td>Value</td></tr> <tr><td>enumeration</td><td>1</td></tr> <tr><td>enumeration</td><td>2</td></tr> <tr><td>enumeration</td><td>3</td></tr> <tr><td>enumeration</td><td>4</td></tr> </table>	Kind	Value	enumeration	1	enumeration	2	enumeration	3	enumeration	4
Kind	Value										
enumeration	1										
enumeration	2										
enumeration	3										
enumeration	4										

simpleType **Eventi_Ecc_Type**

type	restriction of xs:string										
facets	<table><thead><tr><th>Kind</th><th>Value</th></tr></thead><tbody><tr><td>enumeration</td><td>1</td></tr><tr><td>enumeration</td><td>2</td></tr><tr><td>enumeration</td><td>3</td></tr><tr><td>enumeration</td><td>4</td></tr></tbody></table>	Kind	Value	enumeration	1	enumeration	2	enumeration	3	enumeration	4
Kind	Value										
enumeration	1										
enumeration	2										
enumeration	3										
enumeration	4										

simpleType **Estero**

type	restriction of xs:string				
facets	<table><thead><tr><th>Kind</th><th>Value</th></tr></thead><tbody><tr><td>enumeration</td><td>EE</td></tr></tbody></table>	Kind	Value	enumeration	EE
Kind	Value				
enumeration	EE				

simpleType **PE_Type**

type	union of (ProvinciItaliane , Estero)
------	--

simpleType **PN_Type**

type	union of (ProvinciItaliane , ProvincieCroate , Estero , ProvincieSoppresse)
------	---

simpleType **PR_Type**

type	union of (ProvinciItaliane)
------	---

simpleType **ProvincieCroate**

type	restriction of xs:string								
facets	<table><thead><tr><th>Kind</th><th>Value</th></tr></thead><tbody><tr><td>enumeration</td><td>FU</td></tr><tr><td>enumeration</td><td>PL</td></tr><tr><td>enumeration</td><td>ZA</td></tr></tbody></table>	Kind	Value	enumeration	FU	enumeration	PL	enumeration	ZA
Kind	Value								
enumeration	FU								
enumeration	PL								
enumeration	ZA								

simpleType **ProvinciItaliane**

type	restriction of xs:string																																				
facets	<table><thead><tr><th>Kind</th><th>Value</th></tr></thead><tbody><tr><td>enumeration</td><td>AG</td></tr><tr><td>enumeration</td><td>AL</td></tr><tr><td>enumeration</td><td>AN</td></tr><tr><td>enumeration</td><td>AO</td></tr><tr><td>enumeration</td><td>AP</td></tr><tr><td>enumeration</td><td>AQ</td></tr><tr><td>enumeration</td><td>AR</td></tr><tr><td>enumeration</td><td>AT</td></tr><tr><td>enumeration</td><td>AV</td></tr><tr><td>enumeration</td><td>BA</td></tr><tr><td>enumeration</td><td>BG</td></tr><tr><td>enumeration</td><td>BI</td></tr><tr><td>enumeration</td><td>BL</td></tr><tr><td>enumeration</td><td>BN</td></tr><tr><td>enumeration</td><td>BO</td></tr><tr><td>enumeration</td><td>BR</td></tr><tr><td>enumeration</td><td>BS</td></tr></tbody></table>	Kind	Value	enumeration	AG	enumeration	AL	enumeration	AN	enumeration	AO	enumeration	AP	enumeration	AQ	enumeration	AR	enumeration	AT	enumeration	AV	enumeration	BA	enumeration	BG	enumeration	BI	enumeration	BL	enumeration	BN	enumeration	BO	enumeration	BR	enumeration	BS
Kind	Value																																				
enumeration	AG																																				
enumeration	AL																																				
enumeration	AN																																				
enumeration	AO																																				
enumeration	AP																																				
enumeration	AQ																																				
enumeration	AR																																				
enumeration	AT																																				
enumeration	AV																																				
enumeration	BA																																				
enumeration	BG																																				
enumeration	BI																																				
enumeration	BL																																				
enumeration	BN																																				
enumeration	BO																																				
enumeration	BR																																				
enumeration	BS																																				

enumeration	BT
enumeration	BZ
enumeration	CA
enumeration	CB
enumeration	CE
enumeration	CH
enumeration	CI
enumeration	CL
enumeration	CN
enumeration	CO
enumeration	CR
enumeration	CS
enumeration	CT
enumeration	CZ
enumeration	EN
enumeration	FC
enumeration	FE
enumeration	FG
enumeration	FI
enumeration	FM
enumeration	FR
enumeration	GE
enumeration	GO
enumeration	GR
enumeration	IM
enumeration	IS
enumeration	KR
enumeration	LC
enumeration	LE
enumeration	LI
enumeration	LO
enumeration	LT
enumeration	LU
enumeration	MB
enumeration	MC
enumeration	ME
enumeration	MI
enumeration	MN
enumeration	MO
enumeration	MS
enumeration	MT
enumeration	NA
enumeration	NO
enumeration	NU
enumeration	OG
enumeration	OR
enumeration	OT
enumeration	PA
enumeration	PC
enumeration	PD
enumeration	PE
enumeration	PG
enumeration	PI
enumeration	PN
enumeration	PO
enumeration	PR
enumeration	PT
enumeration	PU
enumeration	PV
enumeration	PZ
enumeration	RA
enumeration	RC
enumeration	RE
enumeration	RG
enumeration	RI
enumeration	RM
enumeration	RN
enumeration	RO
enumeration	SA
enumeration	SI

	enumeration	SO
	enumeration	SP
	enumeration	SR
	enumeration	SS
	enumeration	SU
	enumeration	SV
	enumeration	TA
	enumeration	TE
	enumeration	TN
	enumeration	TO
	enumeration	TP
	enumeration	TR
	enumeration	TS
	enumeration	TV
	enumeration	UD
	enumeration	VA
	enumeration	VB
	enumeration	VC
	enumeration	VE
	enumeration	VI
	enumeration	VR
	enumeration	VS
	enumeration	VT
	enumeration	VV

simpleType **ProvincieSoppresse**

type	restriction of xs:string	
facets	Kind	Value
	enumeration	FO
	enumeration	PS

Schema fornitura734_2024_v1.xsd

schema location: **fornitura734_2024_v1.xsd**
attributeFormDefault: **unqualified**
elementFormDefault: **qualified**
targetNamespace: **urn:www.agenziaentrate.gov.it:specificheTecniche:sco:730**

Elements

[Fornitura730-4](#)

element Fornitura730-4

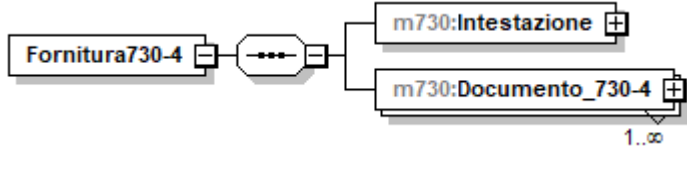
diagram	
children	m730:Intestazione m730:Documento_730-4

element Fornitura730-4/Intestazione

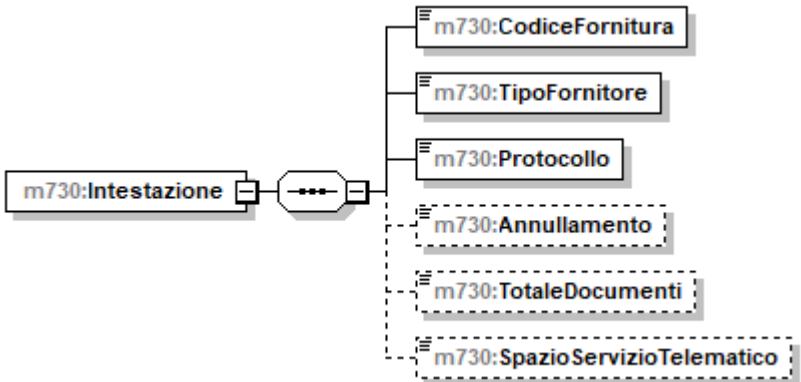
diagram	
children	m730:CodiceFornitura m730:TipoFornitore m730:Protocollo m730:Annullamento m730:TotaleDocumenti m730:Spazio Servizio Telematico

element Fornitura730-4/Intestazione/CodiceFornitura

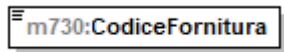
diagram	
type	DatoAN_Type

element **Fornitura730-4/Intestazione/TipoFornitore**

diagram	
type	DatoNP_Type

element **Fornitura730-4/Intestazione/Protocollo**

diagram	
type	restriction of DatoAN_Type

element **Fornitura730-4/Intestazione/Annullamento**

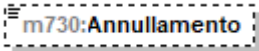
diagram	
type	DatoCB_Type

element **Fornitura730-4/Intestazione/TotaleDocumenti**

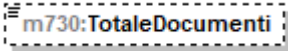
diagram	
type	DatoNP_Type

element **Fornitura730-4/Intestazione/SpazioServizioTelematico**

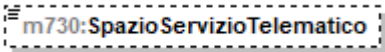
diagram	
type	restriction of DatoAN_Type

element Fornitura730-4/Documento_730-4

<p>diagram</p>	<p>The diagram illustrates the structure of the <code>m730:Documento_730-4</code> element. It is an extension of the base type <code>m730:Documento_730-4</code>. The base type has a multiplicity of <code>1..∞</code>. The extension includes the following elements:</p> <ul style="list-style-type: none"> <code>m730:DatiAnagraficiDichiarante</code> (solid box) <code>m730:Sostituto</code> (dashed box) <code>m730:SoggettoAssFiscale730-4</code> (dashed box) <code>m730:AltriDati</code> (dashed box) <code>m730:DatiContabili730-4</code> (dashed box) <code>m730:DatiServizioTelematico</code> (dashed box)
<p>type</p>	<p>extension of m730:Documento_730-4</p>
<p>children</p>	<p>m730:DatiAnagraficiDichiarante m730:Sostituto m730:SoggettoAssFiscale730-4 m730:AltriDati m730:DatiContabili730-4 m730:DatiServizioTelematico</p>

element Fornitura730-4/Documento_730-4/DatiServizioTelematico

<p>diagram</p>	<p>The diagram shows the <code>m730:DatiServizioTelematico</code> element, which is a restriction of the <code>DatoAN_Type</code>.</p>
<p>type</p>	<p>restriction of DatoAN_Type</p>